



# SILCA NEWS 03/15

ALL THE NEW KEYS, AUTOMOTIVE SOLUTIONS, KEY CUTTING MACHINES, SOFTWARE UPDATES AND MUCH MORE







## Contents

New Keys	1
Empty Shells - New References	2
Vehicle Keys Guide	3, 4
Silca Key Programs and Futura Software Update	5-9
Optional Accessories for Key Cutting Machines	10-15

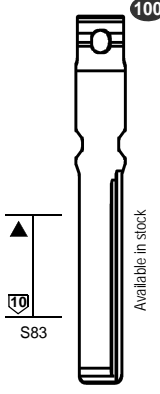
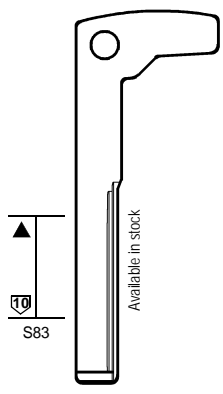
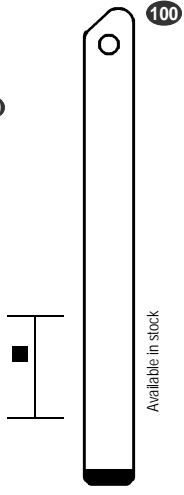
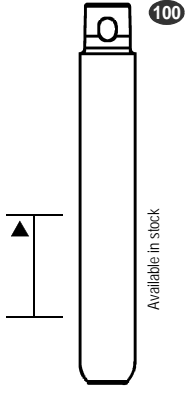
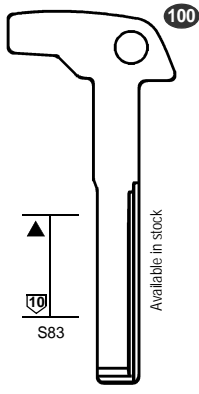





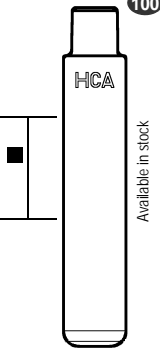
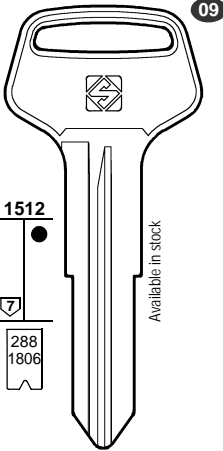
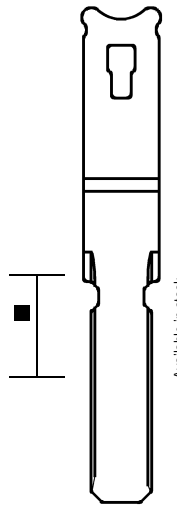

New Keys / Chiavi Nuove / Neue Schlüssel / Nouvelles Clés / Llaves Nuevas / Chaves Nuevas

FOR: PER:	HUF				
					
	Available in stock	Available in stock	Available in stock	Available in stock	Available in stock
	..... 1-6700	..... 1-6700			..... 1-6700
					
	<b>HU116T</b>	<b>HU126T</b>	<b>HU127T</b>	<b>HU135T</b>	<b>HU138T</b>

FOR / PER
HUF (D)
SUZUKI (J)
WITTE (D)

FOR: PER:	HUF	SUZUKI	WITTE
			
	Available in stock	Available in stock	Available in stock
	..... 1-6700	..... 51001-52500 ..... 3001-4500 ..... 18100-19299 ..... 19300-19617	..... 1-6700
			
	<b>HU141T</b>	<b>SZ16R</b>	<b>WT52T</b>

**01**  
 COMMERCIAL GROUP  
 GRUPPO COMMERCIALE  
 PREISEGRUPPE  
 GROUPE COMMERCIAL  
 GRUPO COMMERCIAL  
 GRUPO COMERCIAL

[www.silca.biz](http://www.silca.biz)



## SILCA EMPTY SHELLS - NEW REFERENCES

 Silca Empty Shells: **3 new keys references** to widen the existing range.

 Silca Empty Shells: **3 nouvelles références** clés qui complètent la gamme existante.

 Silca Empty Shells: **3 nuove referenze** chiavi che implementano la gamma già esistente.

 Silca Empty Shells: **3 nuevas referencias** llaves que completan la gama existente.

 Silca Empty Shells: **3 Schlüssel Referenzen** die das bestehende Angebot implementieren.

 Silca Empty Shells: **3 novas referências** chaves que implementam a gama existente.

Brand	References/Image	Specifications	Vehicle Models*																				
AUDI®	<p><b>HURSC2</b></p>  <p>Available in Stock</p>	2 Buttons	<table border="1"> <thead> <tr> <th>MODELS</th> <th>YEAR FROM</th> <th>YEAR TO</th> <th>TRANSPONDER TYPE</th> <th>TRP ID</th> </tr> </thead> <tbody> <tr> <td>A3</td> <td>1997</td> <td>2000</td> <td>MEG/CR</td> <td>48</td> </tr> <tr> <td>A4</td> <td>1997</td> <td>2001</td> <td>MEG/CR</td> <td>48</td> </tr> <tr> <td>A6</td> <td>1997</td> <td>2001</td> <td>MEG/CR</td> <td>48</td> </tr> </tbody> </table>	MODELS	YEAR FROM	YEAR TO	TRANSPONDER TYPE	TRP ID	A3	1997	2000	MEG/CR	48	A4	1997	2001	MEG/CR	48	A6	1997	2001	MEG/CR	48
MODELS	YEAR FROM	YEAR TO	TRANSPONDER TYPE	TRP ID																			
A3	1997	2000	MEG/CR	48																			
A4	1997	2001	MEG/CR	48																			
A6	1997	2001	MEG/CR	48																			
AUDI®	<p><b>HURSC8</b></p>  <p>Available in Stock</p>	3 Buttons	<table border="1"> <thead> <tr> <th>MODELS</th> <th>YEAR FROM</th> <th>YEAR TO</th> <th>TRANSPONDER TYPE</th> <th>TRP ID</th> </tr> </thead> <tbody> <tr> <td>A3</td> <td>1997</td> <td>2004</td> <td>MEG/CR</td> <td>48</td> </tr> <tr> <td>A4</td> <td>1997</td> <td>2004</td> <td>MEG/CR</td> <td>48</td> </tr> <tr> <td>A6</td> <td>1997</td> <td>2004</td> <td>MEG/CR</td> <td>48</td> </tr> </tbody> </table>	MODELS	YEAR FROM	YEAR TO	TRANSPONDER TYPE	TRP ID	A3	1997	2004	MEG/CR	48	A4	1997	2004	MEG/CR	48	A6	1997	2004	MEG/CR	48
MODELS	YEAR FROM	YEAR TO	TRANSPONDER TYPE	TRP ID																			
A3	1997	2004	MEG/CR	48																			
A4	1997	2004	MEG/CR	48																			
A6	1997	2004	MEG/CR	48																			
OPEL-VAUXHALL®	<p><b>HURSG8N</b></p>  <p>Available in Stock</p>	3 Buttons NO battery holder	<table border="1"> <thead> <tr> <th>MODELS</th> <th>YEAR FROM</th> <th>YEAR TO</th> <th>TRANSPONDER TYPE</th> <th>TRP ID</th> </tr> </thead> <tbody> <tr> <td>ASTRA</td> <td>1998</td> <td>2004</td> <td>PH/CR</td> <td>40</td> </tr> <tr> <td>OMEGA</td> <td>1998</td> <td>2004</td> <td>PH/CR</td> <td>40</td> </tr> </tbody> </table>	MODELS	YEAR FROM	YEAR TO	TRANSPONDER TYPE	TRP ID	ASTRA	1998	2004	PH/CR	40	OMEGA	1998	2004	PH/CR	40					
MODELS	YEAR FROM	YEAR TO	TRANSPONDER TYPE	TRP ID																			
ASTRA	1998	2004	PH/CR	40																			
OMEGA	1998	2004	PH/CR	40																			

















\* The uses of the keys are purely indicative and may be subject to updates and revisions. / Gli utilizzi delle chiavi sono da considerarsi puramente indicativi e possono essere oggetto di aggiornamenti e revisioni. / Die Abbildung und technischen Daten der Schlüssel sind nicht bindend. Silca behält sich Änderungen am Produkt, die zur Verbesserung beitragen, vor. / Les usages des clés sont purement indicatifs; ils peuvent être mis à jour et revus. / Los usos de las llaves deben considerarse puramente indicativos y pueden ser objeto de actualizaciones y revisiones. / As utilizações das chaves devem ser consideradas puramente indicativas e podem ser objecto de actualizações e revisões.

® Registered Trademarks. / ® Marchi Registrati. / ® Eingetragene Marken. / ® Marques Déposées. / ® Marcas Registradas. / ® Marcas Registradas.



Car Keys Guide / Guida Chiavi Auto / Marktführer für Autoschlüssel / Guide Clés pour Voitures  
 Guía Llaves para Coches / Guia Chaves para Carros

**New Updates**

1	2	2a	3	3a	3b	E1+E2		6	42+71	72	43 44a	12	15
						GTI COMPATIBLE		IGNITION 					
CAR MAKE MODEL	FROM	TO	SILCA REF.	SILCA REF.	SILCA REF.	COPY	GEN.	TRANSP. TYPE	FAST COPY PLUS RW4 PLUS FAST COPY / RW4	FAST COPY PLUS RW4 PLUS	FAST COPY RW4	STP	
													
For more info on the uses of car keys, refer to the Silca Electronic Key Catalogue: 													
<b>AUDI®</b>													
A3	1997	2000	HURSC2					MEG/CR	48				
A3	1997	2004	HURSC8					MEG/CR	48				
A4	1997	2001	HURSC2					MEG/CR	48				
A4	1997	2004	HURSC8					MEG/CR	48				
A6	1997	2001	HURSC2					MEG/CR	48				
A6	1997	2004	HURSC8					MEG/CR	48				
<b>BMW®</b>													
VARIOUS MODELS			HU127										
<b>CITROËN®</b>													
VARIOUS MODELS			HU141T										
<b>HYUNDAI®</b>													
VARIOUS MODELS			HU135T										
<b>MERCEDES®</b>													
VARIOUS MODELS			HU126T										
VARIOUS MODELS			HU144T										
VARIOUS MODELS			HU138T										
VARIOUS MODELS			HU116T										
VARIOUS MODELS			HU148T										
<b>OPEL-VAUXHALL®</b>													
ASTRA	1998	2004	HURSG8N					PH / CR	40	ID	ID		
OMEGA	1998	2004	HURSG8N					PH / CR	40	ID	ID		
<b>PEUGEOT®</b>													
VARIOUS MODELS			HU141T										
<b>SUZUKI®</b>													
VARIOUS MODELS			SZ16R										
<b>VOLVO®</b>													
VARIOUS MODELS			WT52T										

\* The uses of the keys are purely indicative and may be subject to updates and revisions. / Gli utilizzi delle chiavi sono da considerarsi puramente indicativi e possono essere oggetto di aggiornamenti e revisioni. / Die Abbildung und technischen Daten der Schlüssel sind nicht bindend. Silca behält sich Änderungen am Produkt, die zur Verbesserung beitragen, vor. / Les usages des clés sont purement indicatifs; ils peuvent être mis à jour et revus. / Los usos de las llaves deben considerarse puramente indicativos y pueden ser objeto de actualizaciones y revisiones. / As utilizações das chaves devem ser consideradas puramente indicativas e podem ser objecto de actualizações e revisões.

® Registered Trademarks. / ® Marchi Registrati. / ® Eingetragene Marken. / ® Marques Déposées. / ® Marcas Registradas. / ® Marcas Registradas.

**Truck Keys Guide / Guida Chiavi Camion / Marktführer für LKW Schlüssel  
Guide Clés pour Camions / Guía Llaves para Camiones / Guia Chaves para Camiões**

**New Updates**

1	2	2a	3	3a	3b	E1+E2		6	42+71	72	43 44a	12	15
						GTI COMPATIBLE							
TRUCK MAKE MODEL	FROM	TO	SILCA REF.	SILCA REF.	SILCA REF.	COPY	GEN.	TRANSP. TYPE	FAST COPY PLUS RW4 PLUS FAST COPY / RW4	FAST COPY PLUS RW4 PLUS	FAST COPY RW4	STP	
For more info on the uses of truck keys, refer to the Silca Electronic Key Catalogue:													
<b>MERCEDES®</b>													
ACTROS			HU144T										



**IMPORTANT NOTE:**

See also the "Vehicle Guide Legend"  
Vedi anche la "Legenda Guida Veicoli"  
Siehe auch die "Fahrzeugschlüssel Erläuterung"  
Voir aussi la "Légende Guide Véhicules"  
Véase también la "Leyenda Guía para Vehículos"  
Veja também a "Legenda Guia para Veículos"

## AUTOMOTIVE KEYS RANGE

Discover Silca range visiting [www.silca.biz](http://www.silca.biz) and [ekc.silca.biz](http://ekc.silca.biz).  
Scopri tutta la gamma chiavi collegandoti a [www.silca.biz](http://www.silca.biz) e [ekc.silca.biz](http://ekc.silca.biz).  
Entdecken sie die Schlüsselpalette auf unseren Websites [www.silca.biz](http://www.silca.biz) und [ekc.silca.biz](http://ekc.silca.biz).  
Découvrez la notre gamme de clés directement sur notre site [www.silca.biz](http://www.silca.biz) et [ekc.silca.biz](http://ekc.silca.biz).  
Descubra la gama completa de las llaves visitando [www.silca.biz](http://www.silca.biz) y [ekc.silca.biz](http://ekc.silca.biz).  
Descubra toda a gama de chaves através dos sítios [www.silca.biz](http://www.silca.biz) e [ekc.silca.biz](http://ekc.silca.biz).



\* The uses of the keys are purely indicative and may be subject to updates and revisions. / Gli utilizzi delle chiavi sono da considerarsi puramente indicativi e possono essere oggetto di aggiornamenti e revisioni. / Die Abbildung und technischen Daten der Schlüssel sind nicht bindend. Silca behält sich Änderungen am Produkt, die zur Verbesserung beitragen, vor. / Les usages des clés sont purement indicatifs; ils peuvent être mis à jour et revus. / Los usos de las llaves deben considerarse puramente indicativos y pueden ser objeto de actualizaciones y revisiones. / As utilizações das chaves devem ser consideradas puramente indicativas e podem ser objecto de actualizações e revisões.

© Registered Trademarks. / © Marchi Registrati. / © Eingetragene Marken. / © Marques Déposées. / © Marcas Registradas. / © Marcas Registradas.



## Silca Key Programs

### Update 1/2015 - SKP Vers. 20.6.x.xx

#### UPDATE 1/2015

**New Silca Key Programs 1/2015 Update for all WEB and DVD subscribers.** New items include:

- On CODEMAKER for flat keys a new "NORMAL EASY" cutting method can be used. This method can be selected on many data cards instead of the Normal, Flat or Laser method to reduce cutting vertices and make the key.
- Updated the comparative list.

#### MISE À JOUR 1/2015

**Nouvelle mise à jour Silca Key Programs 1/2015 pour tous les abonnés WEB et DVD.** Parmi les nouveautés:

- Sur CODEMAKER pour clés plates, il est possible d'utiliser une nouvelle taille appelée "NORMAL EASY". Cette méthode peut être sélectionnée dans plusieurs cartes en plus des méthodes Normal, Plate et Laser pour réduire les pointes de tailles et faire la clé.
- Mise à jour des comparatifs.

#### AGGIORNAMENTO 1/2015

**Nuovo Aggiornamento Silca Key Programs 1/2015 per tutti gli abbonati WEB e DVD.** Tra le novità:

- Nel CODEMAKER per chiavi piatte è possibile utilizzare un nuovo metodo di taglio denominato "NORMAL EASY", selezionabile in moltissime schede al posto del metodo Normale, Piano o Laser per ridurre i vertici di cifratura e rendere la chiave più scorrevole nel cilindro.
- Aggiornati i comparativi.

#### ACTUALIZACIÓN 1/2015

**Nueva actualización Silca Key Programs 1/2015 para todos los abonados WEB y DVD.** Entre las novedades:

- En el CODEMAKER para llaves planas es posible utilizar un nuevo método de corte llamado "NORMAL EASY", seleccionable en muchísimas fichas en lugar del método Normal, Plano o Láser para reducir los vértices de cifrado y para que la llave deslice mejor en el cilindro.
- Actualizado el comparativo.

#### AKTUALISIERUNG 1/2015

**Neue Aktualisierung Silca Key Programs 1/2015 für alle WEB und DVD Abonnenten.** Unter den Neuheiten:

- Im CODEMAKER für Flachschlüssel kann eine neue Frästart "NORMAL EASY" benutzt werden. Diese Methode kann auf vielen Datenkarten anstelle der Methode Normal, Flach oder Laser ausgewählt werden, damit die Frässpitzen verringert werden und die Schlüssel leichter in den Zylinder gleiten.
- Die Vergleichsliste wird aktualisiert.

#### ATUALIZAÇÃO 1/2015

**Nova atualização Silca Key Programs 1/2015 para todos o assinantes WEB e DVD.** Entre as novidades:

- No CODEMAKER para chaves planas é possível utilizar um novo método de corte chamado "NORMAL EASY", selecionável em muitas fichas em lugar do método Normal, Plano ou Laser para reduzir os vértices de corte e fazer com que a chave deslize melhor no cilindro.
- Atualizado os comparativos.

> [More info on all Silca websites](#)

## SILCA CODE PROGRAM

Data Update with 19 new cutting cards

SKP Vers. 20.6.x.xx



Unocode 199

Data update with 19 new cutting cards. / Aggiornamento dati con 19 nuove schede. / Datenaktualisierung mit 19 neuen Karten. / Mise à jour des données avec 19 nouvelles fiches. / Actualización datos con 19 fichas nuevas. / Atualização de dados com 19 fichas novas.

New items include: / Tra le novità: / Unter den Neuheiten: / Parmi les nouveautés: / Entre las novedades: / Entre as novidades:



Unocode 299/399

- Goal® AD5
- Metal® X6S - X6V
- Schlage® Everest SFIC
- Snc® – 30/30
- Cisa® CS501
- Bunka®
- Yamaha®
- Honda®



Unocode 399 Evo



Update the software on: / Aggiornare il software di: / Aktualisierung der Software von: / Mettre à jour le logiciel de: / Actualizar el software de: / Atualizar o software de: UC199/UC299/UC399/UC399 EVO.

## SILCA TRIAX - QUATTROCODE PROGRAM

Data Update with 8 new cutting cards

SKP Vers. 20.6.x.xx



Triax Quattro /  
Triax e-code

Data update with 8 new series. / Aggiornamento dati con 8 nuove serie. / Daten-Aktualisierung mit 8 neuen Serien. / Mise à jour des données avec 8 nouvelles séries. / Actualización datos con 8 series nuevas. / Atualização de dados com 8 séries novas.

New items include: / Tra le novità: / Unter den Neuheiten: / Parmi les nouveautés: / Entre las novedades: / Entre as novidades:

- Yale® YA35/40 MSG SN
- Metal® 2x6J 30/30 (6P)
- Trelock® RS430 (4T-7W)
- Iseo® R7 Extra
- Wilka® W500
- Lehmann Prestige® B5
- Agent® BJ-1(5+5+5)
- Showa® W2-DAC (4T-4W)



Quattrocode



Update the software on: / Aggiornare il software di: / Aktualisierung der Software von: / Mettre à jour le logiciel de: / Actualizar el software de: / Atualizar o software de: TRIAX e-code, TRIAX QUATTRO.

## SILCA TRANSPONDER PROGRAM

Data Update with 70 new vehicle applications

STP Vers. 03.16.076



RW4 / RW4 Plus



Fast Copy /  
Fast Copy Plus

**UK** The Silca Transponder Program has been updated with 70 new vehicle applications.

- New software version 03.16.076 for all RW devices.
- Added Dutch and Hungarian.

**DE** Das Silca Transponder Program wurde mit 70 neuen Autoapplikationen aktualisiert.

- Neue Softwareversion 03.16.076 für alle RW-Geräte.
- Hinzufügen Sprache: Holländisch und Ungarisch.

**ES** Se ha actualizado el Silca Transponder Program con 70 nuevas aplicaciones vehículo.

- Nueva versión de software 03.16.076 para todos los dispositivos RW.
- Agregado los idiomas holandés y húngaro.

**IT** Il Silca Transponder Program è stato aggiornato con 70 nuove applicazioni auto.

- Nuova versione Software 03.16.076 per tutti i dispositivi RW.
- Aggiunta di olandese e ungherese.

**FR** Silca Transponder Program a été mis à jour avec 70 nouvelles applications auto.

- Nouvelle version Software 03.16.076 pour tous les dispositifs Transponder.
- Ajoutée des langues néerlandais et hongrois.

**PT** O Silca Transponder Program foi atualizado com 70 novas aplicações para automóvel.

- Nova versão de software 03.16.076 para todos os dispositivos RW.
- Adicionado as línguas holandesa e húngara.



Update the software on: / Aggiornare il software di: / Aktualisierung der Software von: / Mettre à jour le logiciel de: / Actualizar el software de: / Atualizar o software de: RW4, RW4 PLUS, FAST COPY, FAST COPY PLUS.

## SILCA REMOTE SERVICE

Utility Update

SRS Vers. 1.0.32.5



**UK** SRS, the utility for updating programs on board devices in the RW and Optika families, Futura and Easy Scan over the Internet, has been updated.

**DE** SRS, das Utility zur Aktualisierung des internen Programms der Geräte in den Familien RW, Optika, Futura und Easy Scan über Internet, wurde aktualisiert.

**ES** Se ha actualizado SRS, la utility para actualizar el programa interior de los dispositivos de la familia RW, Optika, Easy Scan y Futura por medio de Internet.

**IT** SRS, l'utility per l'aggiornamento del programma interno dei dispositivi della famiglia RW, Optika, Futura e Easy Scan tramite Internet, è stato aggiornato.

**FR** SRS, l'utilitaire pour la mise à jour du programme interne des dispositifs de la famille RW, Optika, Futura et Easy Scan sur Internet, a été mis à jour.

**PT** SRS, o utilitário para a atualização do programa interno dos dispositivos da família RW, de Optika, Futura e Easy Scan por meio da Internet, foi atualizado.



Click here to download the latest version. / Clicca qui per scaricare l'ultima versione. / Klicken Sie hier, um die neueste Version herunterzuladen. / Cliquez ici pour télécharger la dernière version. / Haga clic aquí para descargar la última versión. / Clique aqui para baixar a versão mais recente.



## SILCA FUTURA PROGRAM

Data Update with new main series

FUTURA Vers. 2.9.0



Futura

Data update with new main series. / Aggiornamento dati con nuove serie principali. / Datenaktualisierung mit neuen Hauptserien. / Mise à jour des données avec nouvelles séries principales. / Actualización de datos con nuevas series principales. / Atualização de dados com novas séries principais.

- Agent® BJ-1(5+5+5)
- BKS® WS42 - WS50 MK
- Bunka®
- Ces® UDM (4P) - WSM NEW (5+5+6)
- Dom® (Dom RS8)
- Dom® IX5 DAS (pf.038/101)
- Dom® IX6 SR E (prof.232)
- Dom® IX6 SR E (prof.233)
- Dom® IX6KG (prof. 102) (5+5+5)
- Dom® IX6SR E (prof. 230)
- Dom® IX6SR E (prof. 235)
- Dom® IX6SR E (prof. 129/130/241) MK
- Dom® IX6SR E (prof.131/132/233) MK
- Dom® IX6SR E (prof.232/234) AT
- Dorma® 2 in 1 (Prof. 233) (5P)
- Ezcurra® DS10/15 (5+5)
- FCV® (6P) - (6+5+4)
- Giobert® Alfa Romeo® GT2AP - (5+5)
- Lancia® GT2 (5+5)
- Goal® AD5
- Honda®
- Iseo® R7 Extra
- Metal® X6S - X6V
- Mg® HS Plus (5+5+5)
- Schlage® Everest SFIC
- Showa® W2-DAC (4T-4W)
- Snc® - 30/30
- Titan® T200
- Wilka® PR300
- Wilka® Carat - P3
- Wilka® Carat - P1
- Wilka® PR100
- Yamaha®

® are registered trademarks. / sono marchi registrati. / sind eingetragene Marken. / sont des marques déposées. / son marcas registradas. / são marcas registradas.

## SILCA FUTURA PROGRAM

New Functions

FUTURA Vers. 2.9.0

New Functions / Nuove Funzioni / Neue Funktionen / Nouvelles Fonctions / Nuevas Funciones / Novas Funções

-  - New Function “Cutting Tree” from “Card => Partial cuts”. This function shows you how to recut multiple codes onto the same key blank so you can test each one and use a minimum number of key blanks.
- New Function “Cutting speed tuning” on Copy by original, copy by card for standard, laser and dimple keys. Using this function, it's possible to change the “cutting speed” and the “Depth removal step” according to the thickness and the material of the blank key to be cut.
- Turkish language.

-  - Nuova funzione “Albero di taglio” accessibile da “scheda => intagli parziali”. Questa funzione mostra come cifrare più combinazioni sulla stessa chiave, che può essere provata nel cilindro, utilizzando il minor numero di chiavi possibile.
- Nuova funzione “Variazione della velocità di taglio” in copia da originale e in copia a scheda per chiavi piatte, laser e punzonate. Tale funzione permette all'utente di modificare la velocità di avanzamento e l'asportazione di materiale in base al materiale e allo spessore della chiave da cifrare.
- Lingua Turca.



Remember to update the Silca.apk after installing the Software update (see the on board Instructions Manual - Ch 6.2 APP UPDATE (apk)).



Ricordarsi di aggiornare il Silca.apk dopo l'installazione dell'aggiornamento (vedi istruzioni nel Manuale d'uso - Cap. 6.2 AGGIORNAMENTO APP (apk)).

## SILCA FUTURA PROGRAM New Functions

FUTURA Vers. 2.9.0

New Functions / Nuove Funzioni / Neue Funktionen / Nouvelles Fonctions / Nuevas Funciones / Novas Funções

- Neue Funktion **“Fräswelle” erreichbar über “Karte => Teilfräsungen”**. Diese Funktion zeigt wie mehrere Kombinationen auf dem selben Schlüssel gefräst werden können. Am Zylinder zu testen, um möglichst wenige Schlüssel zu verwenden.

- Neue Funktion **“Änderung der Fräsgeschwindigkeit”** beim Kopieren vom Original und beim Kopieren von Karte bei Flach-, Bahnen- und Bohrmuldenschlüssel. Diese Funktion ermöglicht es dem Nutzer die Geschwindigkeit des Fräsvorgangs und der Materialabtragung je nach Material und Stärke des zu fräsenden Schlüssels zu ändern.

- **Türkische Sprache.**



Erinnern Sie sich die Silca apk nach der Installation des Updates zu aktualisieren (siehe Anleitungen des Betriebs-Handbuches - Kap. 6.2 UPDATE DER APP (apk)).

- Nouvelle fonction **“Arbre de taillage” accessible de “onglet => entailles partielles”**. Cette fonction montre comment tailler plusieurs combinaisons sur la même clé, qui peut être testée dans le cylindre, en utilisant le moins de clés possible.

- Nouvelle fonction de **“Variation de la vitesse de taillage”** par copie à partir d'un original et de copie à partir d'un onglet pour les clés plates, laser et points. Grâce à cette fonction, l'utilisateur pourra modifier la vitesse d'amenage et l'ablation de matériau en fonction du dit matériau et de l'épaisseur de la clé à tailler.

- **Turc.**



Mettre à jour Silca.apk après l'installation de la mise à jour (voir instructions dans le Mode d'Emploi - Chap. 6.2 MISE À JOUR APP (apk)).

- Nueva función **“Gama de cortes” accesible desde la “tarjeta => cortes parciales”**. Esta función muestra el modo para cortar varias combinaciones en la misma llave, que puede probarse en el cilindro, y utilizar así el menor número posible de llaves.

- Nueva función **“Variación de la velocidad de corte”** en copia desde original y en copia en tarjeta para llaves planas, láser y de seguridad. Dicha función permite al usuario modificar la velocidad de avance y la extracción de material según el material y el grosor de la llave cortada.

- **Idioma turco.**



Se recuerda que Silca.apk se ha de actualizar tras instalar la actualización (véanse las instrucciones del Manual de uso - Cap. 6.2 ACTUALIZACIÓN DE LA APP (apk)).

- Nova função **“Veio de corte” alcançável de “ficha => entalhes parciais”**. Esta função mostra como cortar mais combinações na mesma chave, que pode ser provada no cilindro, utilizando o menor número de chaves possível.

- Nova função **“Variação da velocidade de corte”** na cópia de original e na cópia de ficha para chaves planas, laser e de pontos. Essa função permite ao utilizador modificar a velocidade de avanço e a remoção de material de acordo com o material e a espessura da chave a cortar.

- **Idioma Turco.**



Lembrar de atualizar o Silca.apk após a instalação da atualização (ver as instruções no Manual de Utilização - Cap. 6.2 ATUALIZAÇÃO APP (apk)).

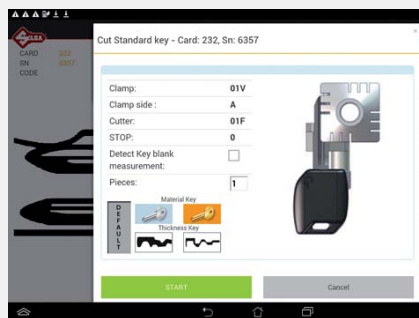

Standard key cutting

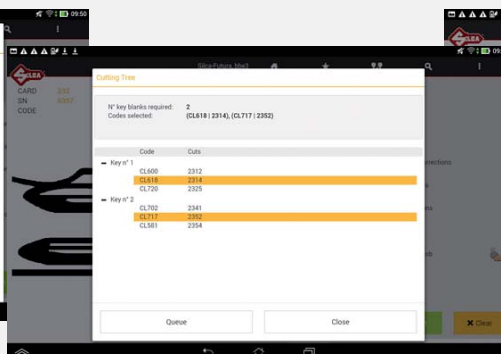

Cutting tree function

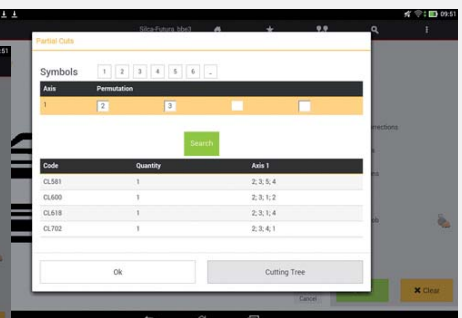

Partial cuts function

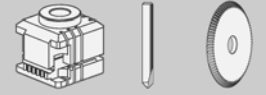
**Accessories / Accessori / Zubehör / Accessoires / Accesorios / Acessórios**

 FOR:  
PER:

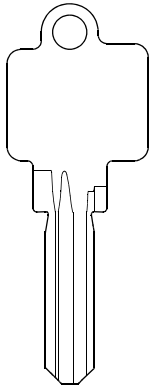
**BKS (D)**

(WS42)

**FUTURA**

&gt; SW Futura 2.9

OPTIONAL

**NEW**
**D744485ZB**

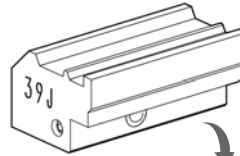
 39J Jaw  
Ganascia 39J  
39J Backe  
Mâchoire 39J  
Quijada 39J  
Garra 39J

OPTIONAL

**NEW**
**D744482ZB**

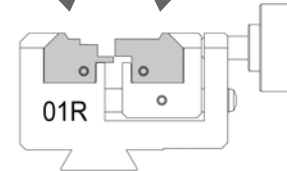
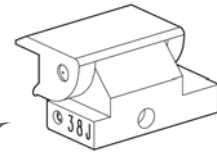
 38J Jaw  
Ganascia 38J  
38J Backe  
Mâchoire 38J  
Quijada 38J  
Garra 38J

 Delivery time MARCH 2015  
Disponibilit  MARZO 2015  
Lieferbar M RZ 2015  
Disponibilit  MARS 2015  
Disponibilidad MARZO 2015  
Disponibilidade MAR O 2015

STANDARD

**D742606ZB**

 Cutter 01L  
Fresa 01L  
Fr ser 01L  
Fraise 01L  
Fresa 01L  
Fresa 01L

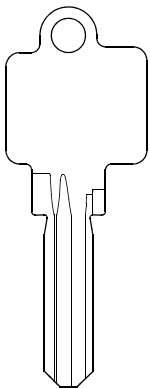
 FOR:  
PER:

**BKS (D)**

(WS50 MK)

**FUTURA**

&gt; SW Futura 2.9

OPTIONAL

**NEW**
**D744480ZB**

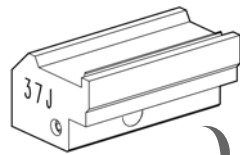
 37J Jaw  
Ganascia 37J  
37J Backe  
M choire 37J  
Quijada 37J  
Garra 37J

OPTIONAL

**NEW**
**D744482ZB**

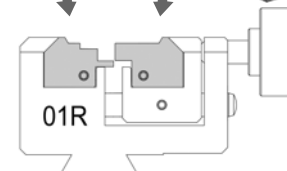
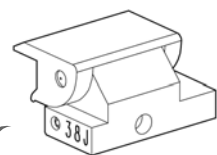
 38J Jaw  
Ganascia 38J  
38J Backe  
M choire 38J  
Quijada 38J  
Garra 38J

 Delivery time MARCH 2015  
Disponibilit  MARZO 2015  
Lieferbar M RZ 2015  
Disponibilit  MARS 2015  
Disponibilidad MARZO 2015  
Disponibilidade MAR O 2015

STANDARD

**D742606ZB**

 Cutter 01L  
Fresa 01L  
Fr ser 01L  
Fraise 01L  
Fresa 01L  
Fresa 01L

FOR:  
PER:

## BKS (D)

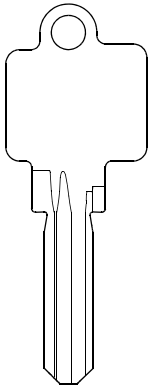

  
(WS50)



**MATRIX PRO - EVO  
MATRIX ONE**



**MATRIX S - SX - SLX**

OPTIONAL



### D744822ZB

*Adapters A42  
Adattatori A42  
Adapters A42  
Adaptateurs A42  
Adaptadores A42  
Adaptadores A42*

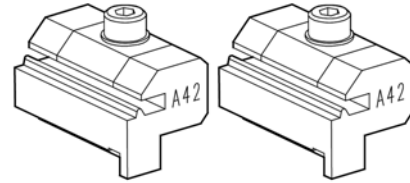

Delivery time MARCH 2015  
Disponibilità MARZO 2015  
Lieferbar MARZ 2015  
Disponibilit  MARS 2015  
Disponibilidad MARZO 2015  
Disponibilidade MARÇO 2015

OPTIONAL

### D740397ZB

*Tracer point T68  
Tastatore T68  
Taster T68  
Palpeur T68  
Palpador T68  
Palpador T68*



### D740474ZB

*Cutter F68  
Fresa F68  
Fr ser F68  
Fraise F68  
Fresa F68*

FOR:  
PER:

## CES (D)

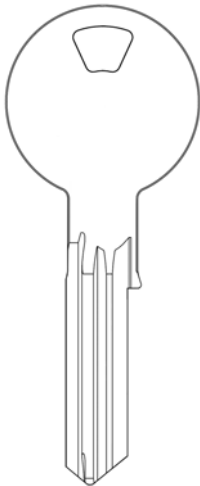

(UDM)



**FUTURA**

> SW Futura 2.9

OPTIONAL



### D744505ZB

*49J Jaw  
Ganascia 49J  
49J Backe  
M choire 49J  
Quijada 49J  
Garra 49J*

OPTIONAL



### D744311ZB

*25J Jaw  
Ganascia 25J  
25J Backe  
M choire 25J  
Quijada 25J  
Garra 25J*

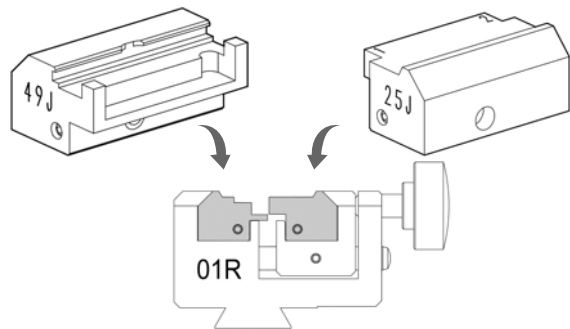

OPTIONAL



### D744513ZB

*Cutter 12D  
Fresa 12D  
Fr ser 12D  
Fraise 12D  
Fresa 12D  
Fresa 12D*

Delivery time MARCH 2015  
Disponibilit  MARZO 2015  
Lieferbar M RZ 2015  
Disponibilit  MARS 2015  
Disponibilidad MARZO 2015  
Disponibilidade MARÇO 2015

*System protected by a password issued by Silca on receipt of authorization.*

*Sistema protetto da password rilasciata da Silca a fronte di autorizzazione.*

*System gesch tzt durch von Silca geliefertes Password auf Genehmigung.*

*Syst me prot g  par un password qui est  mis par Silca sur autorisation.*

*Sistema protegido por password que expide Silca contra autorizaci n.*

*Sistema protegido por uma password emitida por Silca contra a autoriza o.*

FOR:  
PER:

## DOM (D)

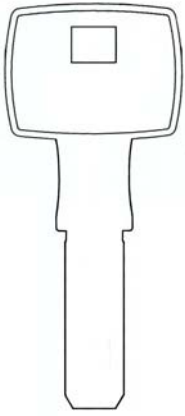

IX6SR E

(prof. 129, 130, 241)

(prof. 131, 132, 233)

(prof. 230, 232, 234, 235)

*System protected by a password issued by Silca on receipt of authorization.*

*Sistema protetto da password rilasciata da Silca a fronte di autorizzazione.*

*Sysyem geschützt durch von Silca geliefertes Password auf Genehmigung.*

*Système protégé par un password qui est émis par Silca sur autorisation.*

*Sistema protegido por password que expide Silca contra autorización.*

*Sistema protegido por uma password emitida por Silca contra a autorização.*



FUTURA

> SW Futura 2.9



OPTIONAL



### D744495ZB

44J Jaw  
Ganascia 44J  
44J Backe  
Mâchoire 44J  
Quijada 44J  
Garra 44J

STANDARD



### D943254ZR

02J Jaw  
Ganascia 02J  
02J Backe  
Mâchoire 02J  
Quijada 02J  
Garra 02J

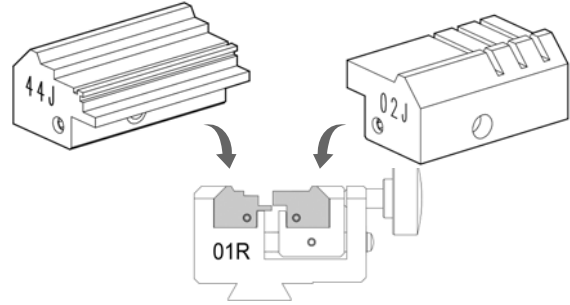

OPTIONAL



### D744508ZB

Cutter 09D  
Fresa 09D  
Fräser 09D  
Fraise 09D  
Fresa 09D  
Fresa 09D

Delivery time MARCH 2015  
Disponibilità MARZO 2015  
Lieferbar MÄRZ 2015  
Disponibilité MARS 2015  
Disponibilidad MARZO 2015  
Disponibilidade MARÇO 2015

FOR:  
PER:

## DOM (D) CORBIN (I)

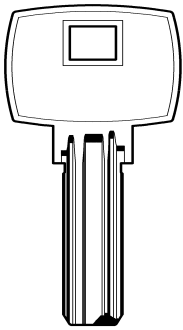

IX5 DAS

(prof. 038/101)



FUTURA

> SW Futura 2.9



OPTIONAL



### D744487ZB

40J Jaw  
Ganascia 40J  
40J Backe  
Mâchoire 40J  
Quijada 40J  
Garra 40J



OPTIONAL



### D744489ZB

41J Jaw  
Ganascia 41J  
41J Backe  
Mâchoire 41J  
Quijada 41J  
Garra 41J

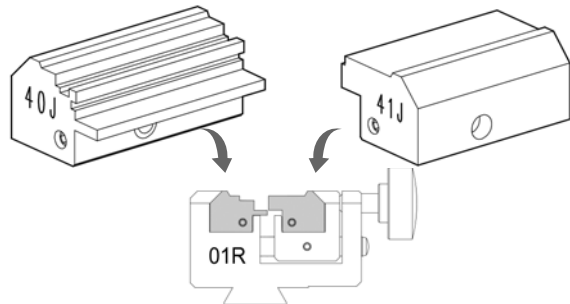

STANDARD



### D742867ZB

Cutter 01D  
Fresa 01D  
Fräser 01D  
Fraise 01D  
Fresa 01D  
Fresa 01D

Delivery time MARCH 2015  
Disponibilità MARZO 2015  
Lieferbar MÄRZ 2015  
Disponibilité MARS 2015  
Disponibilidad MARZO 2015  
Disponibilidade MARÇO 2015

FOR:  
PER:

## DOM (D)

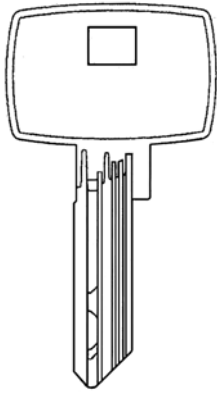

(RS8)



FUTURA

> SW Futura 2.9

OPTIONAL

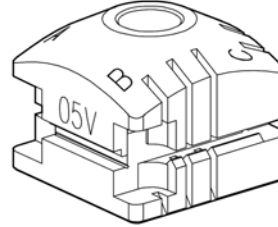

### D744762ZB

05V clamp for DOM RS8 type keys  
Morsetto 05V per chiavi tipo DOM RS8  
Spannbacke 05V für DOM RS8 Schlüsseltyp  
Etau 05V pour clés type DOM RS8  
Mordaza 05V para llaves de tipo DOM RS8  
Mordente 05V para chaves do tipo DOM RS8

Delivery time MARCH 2015  
Disponibilità MARZO 2015  
Lieferbar MÄRZ 2015  
Disponibilit  MARZ 2015  
Disponibilidad MARZO 2015  
Disponibilidade MARÇO 2015

FOR:  
PER:

## LEHMANN (D)

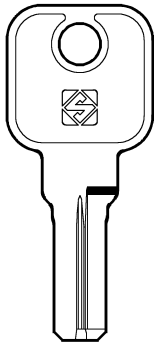

( Prestige B5 )



QUATTROCODE



TRIAX QUATTRO  
TRIAX-E.CODE

OPTIONAL



CARD 3868  
SN 1559

### D744648ZB

Adapter A41  
Adattatore A41  
Adapter A41  
Adaptateur A41  
Adaptador A41  
Adaptador A41

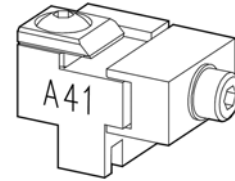

Delivery time MARCH 2015  
Disponibilit  MARZO 2015  
Lieferbar MARZ 2015  
Disponibilit  MARZ 2015  
Disponibilidad MARZO 2015  
Disponibilidade MARÇO 2015

OPTIONAL



### D711604ZB

Cutter W129 (carbide)  
Fr ser W129 (Hartmetall)  
Fraise W129 (au carbure)  
Fresa W129 (metal duro)  
Fresa W129 (metal duro)  
Fresa W129 (metal duro)

Starting from SKP Software version 20.6.0.54  
Dalla versione Software SKP 20.6.0.54  
Ab SKP Software Version 20.6.0.54  
  partir du software SKP version 20.6.0.54  
Desde software SKP versi n 20.6.0.54  
A partir da vers o software SKP 20.6.0.54

OPTIONAL



### D744652ZB

Adapters A41  
Adattatori A41  
Adapters A41  
Adaptateurs A41  
Adaptadores A41  
Adaptadores A41

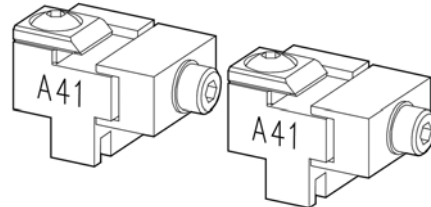

Delivery time MARCH 2015  
Disponibilit  MARZO 2015  
Lieferbar MARZ 2015  
Disponibilit  MARS 2015  
Disponibilidad MARZO 2015  
Disponibilidade MARÇO 2015

OPTIONAL

### D740360ZB

Tracer point T30  
Tastatore T30  
Taster T30  
Palpeur T30  
Palpador T30  
Palpador T30



### D740434ZB

Cutter F30  
Fresa F30  
Fr ser F30  
Fraise F30  
Fresa F30  
Fresa F30



MATRIX PRO - EVO



MATRIX S - SX - SLX

FOR:  
PER:

## MG MONTI (I)

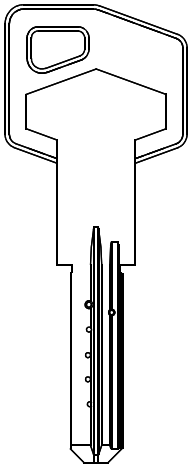

(HSP)

*System protected by a password issued by Silca on receipt of authorization.  
Sistema protetto da password rilasciata da Silca a fronte di autorizzazione.  
System geschützt durch von Silca geliefertes Passwort auf Genehmigung.  
Système protégé par un password qui est émis par Silca sur autorisation.  
Sistema protegido por password que expide Silca contra autorización.  
Sistema protegido por uma password emitida por Silca contra a autorização.*



FUTURA

> SW Futura 2.9



OPTIONAL



### D744491ZB

42J Jaw  
Ganascia 42J  
42J Backe  
Mâchoire 42J  
Quijada 42J  
Garra 42J



OPTIONAL



### D744493ZB

43J Jaw  
Ganascia 43J  
43J Backe  
Mâchoire 43J  
Quijada 43J  
Garra 43J

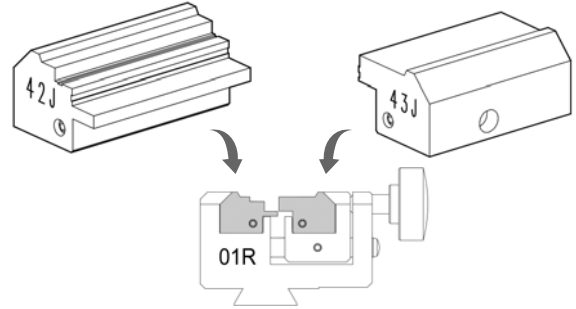

STANDARD



### D742867ZB

Cutter 01D  
Fresa 01D  
Fräser 01D  
Fraise 01D  
Fresa 01D  
Fresa 01D

Delivery time MARCH 2015  
Disponibilità MARZO 2015  
Lieferbar MÄRZ 2015  
Disponibilité MARS 2015  
Disponibilidad MARZO 2015  
Disponibilidade MARÇO 2015

FOR:  
PER:

## WILKA (D)

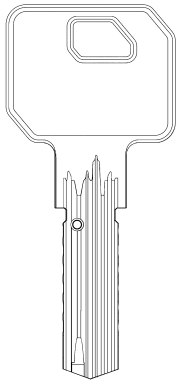

(PR100)  
(Carat - P1)



FUTURA

> SW Futura 2.9

OPTIONAL



### D744309ZB

24J Jaw  
Ganascia 24J  
24J Backe  
Mâchoire 24J  
Quijada 24J  
Garra 24J

OPTIONAL



### D744311ZB

25J Jaw  
Ganascia 25J  
25J Backe  
Mâchoire 25J  
Quijada 25J  
Garra 25J

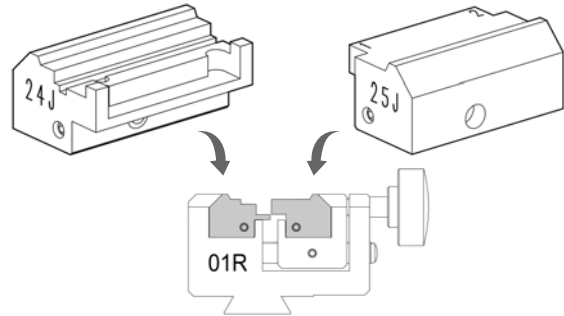

OPTIONAL



### D743673ZB

Cutter 02D  
Fresa 02D  
Fräser 02D  
Fraise 02D  
Fresa 02D  
Fresa 02D

Delivery time MARCH 2015  
Disponibilità MARZO 2015  
Lieferbar MÄRZ 2015  
Disponibilité MARS 2015  
Disponibilidad MARZO 2015  
Disponibilidade MARÇO 2015

FOR:  
PER:

# WILKA (D)

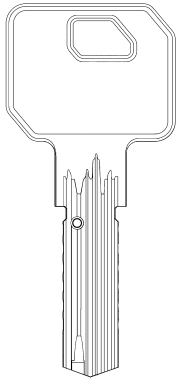

(PR300)  
(Carat - P3)



FUTURA

> SW Futura 2.9

OPTIONAL



## D744503ZB

48J Jaw  
Ganascia 48J  
48J Backe  
Mâchoire 48J  
Quijada 48J  
Garra 48J



OPTIONAL



## D744501ZB

47J Jaw  
Ganascia 47J  
47J Backe  
Mâchoire 47J  
Quijada 47J  
Garra 47J

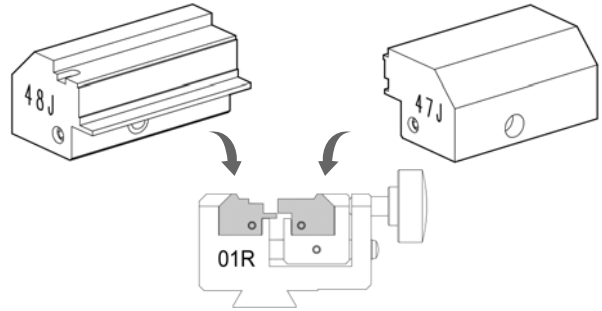

STANDARD



## D742867ZB

Cutter 01D  
Fresa 01D  
Fräser 01D  
Fraise 01D  
Fresa 01D  
Fresa 01D

Delivery time MARCH 2015  
Disponibilità MARZO 2015  
Lieferbar MÄRZ 2015  
Disponibilit  MARS 2015  
Disponibilidad MARZO 2015  
Disponibilidade MARÇO 2015

FOR:  
PER:

# WILKA (D)

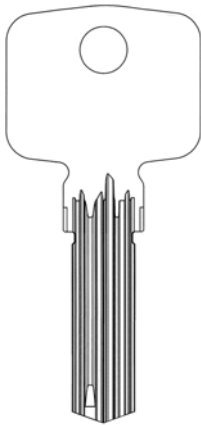

(3VE-W500)



MATRIX PRO - EVO



MATRIX S - SX - SLX

OPTIONAL



## D744801ZB

Adapters A23  
Adattatori A23  
Adapters A23  
Adaptateurs A23  
Adaptadores A23  
Adaptadores A23

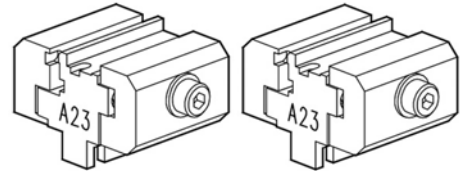

OPTIONAL

## D740341ZB

Tracer point T13  
Tastatore T13  
Taster T13  
Palpeur T13  
Palpador T13  
Palpador T13



## D744803ZB

Cutter F73  
Fresa F73  
Fräser F73  
Fraise F73  
Fresa F73  
Fresa F73

Delivery time MARCH 2015  
Disponibilità MARZO 2015  
Lieferbar MARZ 2015  
Disponibilit  MARS 2015  
Disponibilidad MARZO 2015  
Disponibilidade MARÇO 2015