



SILCA NEWS 01/16

ALL THE NEW KEYS, AUTOMOTIVE SOLUTIONS, KEY CUTTING MACHINES, SOFTWARE UPDATES AND MUCH MORE

Contents

<u>New Keys</u>	1
<u>2016 Silca New Keys Collection</u>	2
<u>Vehicle Key Finder Pro 3.0</u>	3, 4
<u>Silca Key Programs / Futura Update</u>	5
<u>ADC243 Power Cable</u>	6

Vehicle Key Finder Pro 3.0

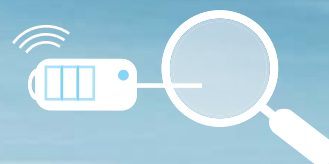



New Keys / Chiavi Nuove / Neue Schlüssel / Nouvelles Clés / Llaves Nuevas / Chaves Nuevas

FOR: PER:		ABUS	CES	CINA	FOR / PER	
		<p>04</p> <p>OV</p> <p>5</p> <p>Available in stock</p> <p>AB101RX</p>	<p>05</p> <p>1056</p> <p>5</p> <p>Available by the end of January</p> <p>CE154</p>	<p>06</p> <p>1684</p> <p>5</p> <p>Available in stock</p> <p>RC11R</p>	ABUS (DE) CES (DE) CINA (CN) IBFM (IT) PREFER (IT) ZEISS IKON (DE)	
		<p>06</p> <p>1549</p> <p>5</p> <p>Available by the end of January</p> <p>IBF2R</p>	<p>06</p> <p>1434</p> <p>5</p> <p>Available by the end of January</p> <p>IBF3R</p>	<p>06</p> <p>31</p> <p>4+4</p> <p>S1632</p> <p>Available by the end of January</p> <p>PF22</p>	<p>04</p> <p>56</p> <p>5</p> <p>Available by the end of January</p> <p>ZE58</p>	01 COMMERCIAL GROUP GRUPPO COMMERCIALE PREISEGRUPPE GROUPE COMMERCIAL GRUPO COMMERCIAL GRUPO COMERCIAL www.silca.biz

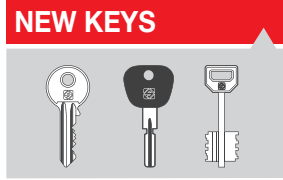

2016 / SILCA NEW KEY COLLECTION

Discover it on all Silca websites



Vehicle Key Finder Pro 3.0

A new perspective for a competitive vehicle key service



INTERACTIVE CATALOGUE



Cloning, programming, duplicating a vehicle key: with VKF Pro 3.0 all the info you need are available in an interactive catalogue.



Clonare, programmare, duplicare una chiave veicolo: con VKF Pro 3.0 tutte le informazioni sempre disponibili in un unico catalogo interattivo.



Autoschlüssel kopieren, programmieren, fräsen: mit VKF Pro 3.0 finden Sie alle Informationen immer in einem einzigen interaktiven Katalog.



Cloner, programmer, reproduire une clé de véhicule: avec VKF Pro 3.0 toutes les informations seront toujours accessibles dans un seul catalogue interactif.



Clonar, programar, duplicar una llave de vehículo: con VKF Pro 3.0 toda la información siempre al alcance en un único catálogo interactivo.



Clonar, programar, duplicar uma chave para veículo: com VKF Pro 3.0 todas as informações estão sempre à disposição num único catálogo interativo.



STEP-BY-STEP GUIDANCE

For every single step of your workflow, VKF Pro 3.0 indicates the key, key cutting machine, cloning device, and software to use, or programming procedure to follow.

Per ogni singola fase di lavorazione VKF Pro 3.0 indica la chiave, la duplicatrice, il dispositivo, il software o la procedura di programmazione da utilizzare.

VKF Pro 3.0 zeigt für jede Bearbeitungsphase den Schlüssel, die Maschine, das Gerät, die Software, das Programmierverfahren an, den/das/die Sie einsetzen müssen.

Pour chaque phase opérationnelle, VKF Pro 3.0 indiquera la clé, la machine, le dispositif, le logiciel ou la procédure de programmation à utiliser.

En cada una de las fases de proceso, VKF Pro 3.0 indica la llave, la máquina, el dispositivo, el software o el procedimiento de programación que usar.

Por cada fase de trabalho, VKF Pro 3.0 indica a chave, a máquina, o dispositivo, o software ou o procedimento de programação a utilizar.



AVAILABLE ON ALL DEVICES

VKF Pro 3.0 is optimized for PC, tablet and smartphone, and is perfect for supporting roadside repairs and installations.

VKF Pro 3.0 è ottimizzato per PC, tablet e smartphone ed è perfetto per supportare in mobilità chi effettua il servizio chiavi presso il veicolo.

VKF Pro 3.0 ist für PC, Tablet und Mobiltelefon optimiert und ideal als Unterstützung für diejenige, die ihren Dienst auch vor Ort anbieten.

VKF Pro 3.0 est optimisé pour PC, Tablet et mobile; parfait pour seconder en mobilité ceux assurant le service sur le véhicule.

VKF Pro 3.0 se ha optimizado para PC, tableta y móvil y es perfecto para quienes se desplazan y efectúan el servicio en el vehículo.

VKF Pro 3.0 é otimizado para PC, tablet e móvel e é perfeito para suportar em mobilidade quem efectuar o serviço junto do veículo.

> Visit ekc.silca.biz/vkf



ALWAYS UP-TO-DATE

VKF Pro 3.0 is easy to click through, complete, practical and is always updated with the latest news from the automotive market.

VKF Pro 3.0 è facile da consultare, completo, pratico ed è sempre aggiornato con le ultime novità del mondo dei veicoli.

VKF Pro 3.0 ist ein bedienerfreundliches und komplettes Tool, und umfasst immer die letzten Neuheiten und Updates aus der Autowelt.

VKF Pro 3.0 est intuitif, complet, pratique, et est toujours à jour avec les dernières nouveautés et les mises à jour du monde des véhicules.

VKF Pro 3.0 es intuitivo, completo, práctico y se actualiza siempre con las últimas novedades y las actualizaciones del mundo de los vehículos.

VKF Pro é intuitivo, completo, práctico e sempre atualizado com as últimas novidades do mundo dos veículos.



EMBEDDED IN MYSILCA APP

VKF Pro 3.0 is embedded in MySilca: click on the links below to download the app from Google Play or the App Store.

VKF Pro 3.0 è integrata in MySilca: clicca sui link qui sotto per scaricare la app da Google Play o App Store.

VKF Pro 3.0 ist in MySilca eingegliedert: Klicken Sie auf die Links hier unten, um die App von Google Play oder App Store herunterzuladen.

VKF Pro 3.0 est intégré dans MySilca: cliquez sur les liens ci-dessous pour télécharger l'app sur Google Play ou l'App Store.

VKF Pro 3.0 está embebido en MySilca: haga clic en los enlaces aquí abajo para descargar la app desde Google Play o App Store.

VKF Pro 3.0 está incrustado en MySilca: clique nos links abaixo para baixar a aplicação de Google Play ou App Store.



REGISTER NOW!

Vehicle Key Finder Pro 3.0 is free and it will only take you a minute to register.

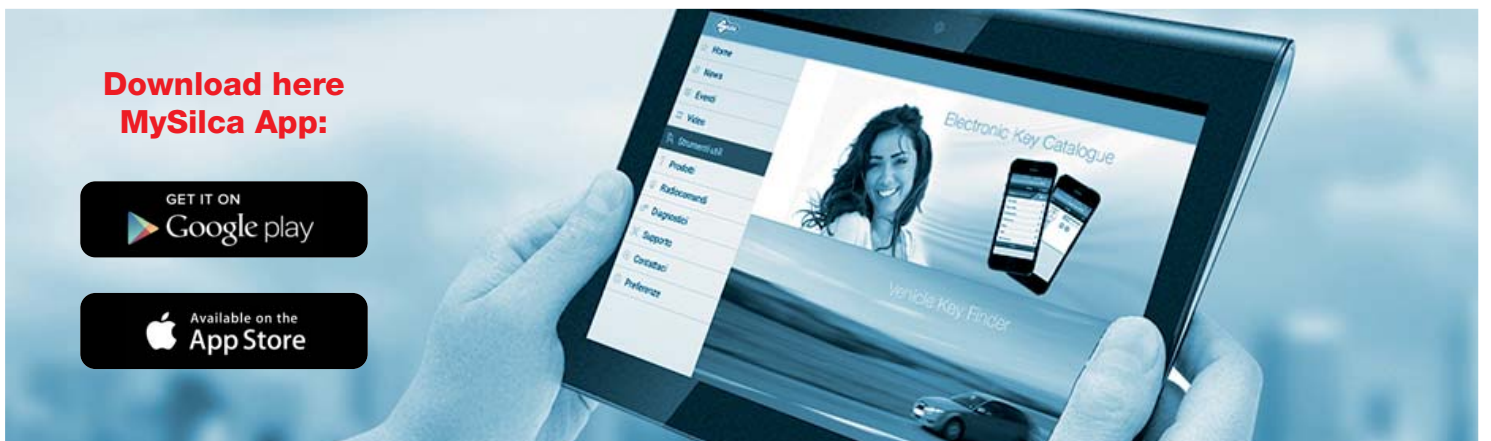

> Visit ekc.silca.biz/vkf



Silca Key Programs - WEB Update

SKP - WEB UPDATE

A new update of the SILCA KEY PROGRAMS software is available to all WEB subscribers.

Check out the "News" section of Silca Key Programs on www.silca.biz to know more.

SKP - MISE À JOUR WEB

Une nouvelle mise à jour du logiciel SILCA KEY PROGRAMS pour tous les abonnements WEB est disponible.

Consultez la section "Nouveautés" de Silca Key Programs sur notre site www.silca.biz pour en savoir plus.

SKP - AGGIORNAMENTO WEB

È disponibile un nuovo aggiornamento del software SILCA KEY PROGRAMS per tutti gli abbonati WEB.

Consulta la sezione "Novità" di Silca Key Programs sul sito www.silca.biz per saperne di più.

SKP - ACTUALIZACIÓN WEB

Una nueva actualización del software SILCA KEY PROGRAMS para todos los abonados WEB está disponible.

Visite la sección "Novedades" de Silca Key Programs en el sitio www.silca.biz para más informaciones.

SKP - AKTUALISIERUNG WEB

Für alle WEB Abonnenten ist eine neue Aktualisierung von der Software SILCA KEY PROGRAMS verfügbar.

Sehen Sie den Abschnitt "Neuheiten" von Silca Key Programs auf www.silca.biz, um weitere Informationen zu finden.

SKP - ATUALIZAÇÃO WEB

Nova atualização do software SILCA KEY PROGRAMS para todos o assinantes WEB está disponível.

Consulte a seção "Novidades" de Silca Key Programs no site www.silca.biz para saber mais.

SILCA FUTURA PROGRAM

Data Update with new systems

Software Vers. 2.15.0 - db 3.00

App Vers. 1.21



Futura

Data update with new systems / Aggiornamento dati con nuovi sistemi / Datenaktualisierung mit neuen Systemen / Mise à jour des données avec nouveaux systèmes / Actualización de datos con sistemas nuevos / Atualização de dados com novos sistemas

New items include / Tra le novità / Unter den Neuheiten / Parmi les nouveautés / Entre las novedades / Entre as novidades:

- | | | |
|-----------------------|------------------------|-------------------|
| - Abus® Abus V63 | - Guard® Profile G17 | Key (5+5+4) |
| - Abus® Abus Z74 | - Huwil® | - Pundra® |
| - Burg® | - Illinois® | - Soficlef® 50/40 |
| - Chicago® | - Jofco® | - Wilka® P2 |
| - Chicago® | - Mazda® Taiwan market | - Wilka® PR300Q |
| - Craftsman® | - Minda-Huf® | - Wilka® P3Q |
| - Federal® YCF 35-35 | - National® | |
| - Ford® Taiwan market | - Nissan® Emergency | |



ADC243 Power Cable - Code D746406AD

For connecting Silca cloning devices to AD programming devices and pre-coding Fiat® transponders

January 2016



TECHNICAL REQUIREMENTS

RW4 Plus / Fast Copy Plus software version	03.20.080
Smart Dongle software version	1.1.5
AD100 Pro / MVP Pro software version	12.32

Le câble ADC243 a été mis au point pour les clients qui utilisent les dispositifs Silca Fast Copy Plus / RW4 Plus (ou Fast Copy + P-Box / RW4 + P-Box) et qui sont dotés d'un dispositif de programmation AD (AD100 Pro ou MVP Pro) et de Smart Dongle. **ADC243 permet raccorder le dispositif de reproduction Silca au dispositif de programmation AD et à Smart Dongle, et de pré-coder les transpondeurs Fiat®.**

O cabo ADC243 foi desenvolvido para os clientes que utilizam os dispositivos Silca Fast Copy Plus / RW4 Plus (ou Fast Copy + P-Box / RW4 + P-Box), e estão equipados com um dispositivo de programação AD (AD100 Pro ou MVP Pro) e de Smart Dongle. **ADC243 permite ligar o dispositivo de clonagem Silca ao dispositivo de programação AD e a Smart Dongle e pré-codificar transponders Fiat®.**

The cable ADC243 is specifically developed for customers who use the Silca Fast Copy Plus / RW4 Plus (or Fast Copy + P-Box / RW4 + P-Box) and also have an AD Pro programming device (AD100 Pro or MVP Pro) with Smart Dongle. **ADC243 allows to pre-code Fiat® transponders by simply connecting your Silca device to AD100 Pro / MVP Pro and Smart Dongle.**

Il cavo ADC243 è stato sviluppato per i clienti che utilizzano i dispositivi Silca Fast Copy Plus / RW4 Plus (o Fast Copy + P-Box / RW4 + P-Box) e sono dotati di un dispositivo di programmazione AD (AD100 Pro o MVP Pro) e di Smart Dongle. **ADC243 consente di collegare il dispositivo Silca al dispositivo di programmazione AD e a Smart Dongle e, in questo modo, pre-codificare i transponder Fiat®.**

Das Kabel ADC243 wurde für die Kunden entwickelt, die die Geräte Silca Fast Copy Plus / RW4 Plus (oder Fast Copy + P-Box / RW4 + P-Box) verwenden und ein AD-Programmiergerät (AD100 Pro oder MVP Pro) und einen Smart Dongle haben. **Mit ADC243 können Sie einen Fiat® Transponder auf der Basis der automatisch von den AD-Programmiergeräten gelesenen Daten vorcodieren. Sie müssen nur das Silca-Kopiergerät an das AD-Programmiergerät und an den Smart Dongle verbinden.**

El cable ADC243 se ha desarrollado para los clientes que usan los dispositivos Silca Fast Copy Plus / RW4 Plus (o Fast Copy + P-Box / RW4 + P-Box) y que cuentan con un dispositivo de programación AD (AD100 Pro o MVP Pro) y Smart Dongle. **ADC243 permite conectar el dispositivo de clonación Silca al dispositivo de programación AD y a Smart Dongle y precodificar transponders Fiat®.**

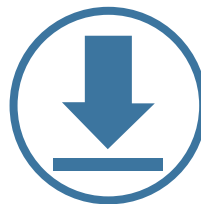

Click here to download the free upgrade of Silca devices to 03.20.080 software version via Silca Remote Service



SILCA NEWS 02/16

ALL THE NEW KEYS, AUTOMOTIVE SOLUTIONS, KEY CUTTING MACHINES, SOFTWARE UPDATES AND MUCH MORE

Contents

<u>New Keys</u>	1
<u>Vehicle Keys Guide</u>	2
<u>New Key Collection available on EKC</u>	3,4
<u>Silca at the 2016 ERSI Convention</u>	5
<u>ADS190SD Hyundai® / Kia® Software</u>	6,7,8
<u>ADS199 Toyota® Smart Reset Software</u>	9
<u>Key Cutting Machine Accessories</u>	10



2016 / SILCA NEW KEY COLLECTION



New Keys / Chiavi Nuove / Neue Schlüssel / Nouvelles Clés / Llaves Nuevas / Chaves Nuevas

FOR: PER:	ABUS	BAB	BASI	EGRET	FOR / PER
	 1335 Available in stock 4 AB102 mm 30	 908 Available in stock 5 BAB26R-22 BAB26R-21 BAB26R-19 BAB26R-20	 1261 Available in stock BAI25 BAI25R 	 1385 Available in stock EGR1	ABUS (DE) BAB (DE) BASI (DE) EGRET (GR) FAB (CZ) SEKUR (AR)
					FORD (AU)
FOR: PER:	FAB	SEKUR	FORD		
	 1361 Available in stock FB31	 1589 Available by the end of February SKR1	 P453 Available by the end of February FO42RTE		
					01 COMMERCIAL GROUP GRUPPO COMMERCIALE PREISEGRUPPE GROUPE COMMERCIAL GRUPO COMMERCIAL GRUPO COMERCIAL www.silca.biz

ALL THE KEYS DISPLAYED ARE AVAILABLE ALSO IN THE SILCA "NEW KEY COLLECTION"



Car Keys Guide / Guida Chiavi Auto / Marktführer für Autoschlüssel / Guide Clés pour Voitures
 Guía Llaves para Coches / Guia Chaves para Carros

New Updates

1	2	2a	3	3a	3b	E1+E2		6	42+71	72	43 44a	12	15
						GTI COMPATIBLE		IGNITION 					
CAR MAKE MODEL	FROM	TO	SILCA REF.	SILCA REF.	SILCA REF.	COPY	GEN.	TRANSP. TYPE	FAST COPY PLUS RW4 PLUS FAST COPY / RW4	FAST COPY PLUS RW4 PLUS	FAST COPY RW4	STP	
For more info on the uses of car keys, refer to the Silca Electronic Key Catalogue:													
FORD® AUS													
ESCAPE	2009	2013		FO42RTE				TEX / CR	63				C
SMART®													
FORFOUR	2004	2006		HU56RTE	HU56RFH		Y	PH / CR2	46				

* The uses of the keys are purely indicative and may be subject to updates and revisions. / Gli utilizzi delle chiavi sono da considerarsi puramente indicativi e possono essere oggetto di aggiornamenti e revisioni. / Die Abbildung und technischen Daten der Schlüssel sind nicht bindend. Silca behält sich Änderungen am Produkt, die zur Verbesserung beitragen, vor. / Les usages des clés sont purement indicatifs; ils peuvent être mis à jour et revus. / Los usos de las llaves deben considerarse puramente indicativos y pueden ser objeto de actualizaciones y revisiones. / As utilizações das chaves devem ser consideradas puramente indicativas e podem ser objecto de actualizações e revisões.

© Registered Trademarks. / © Marchi Registrati. / © Eingetragene Marken. / © Marques Déposées. / © Marcas Registradas. / © Marcas Registradas.

Vehicle Key Finder Pro 3.0



A new perspective for a competitive vehicle key service

Register now!

Vehicle Key Finder Pro 3.0 is free and it will only take you a minute to register:

ekc.silca.biz/vkf

VKF Pro 3.0 in MySilca App



Download here MySilca App



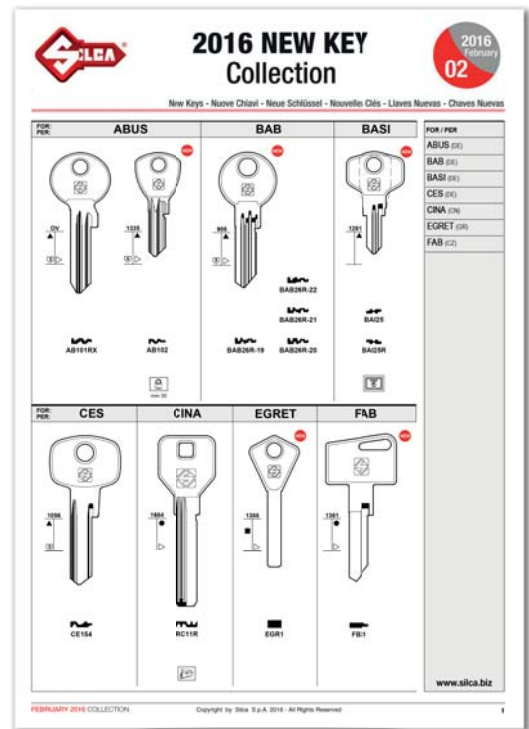

New Key Collection

Silca offers you a new, useful document to support your daily work, helping you find easily, both online and offline, all the new keys launched since the beginning of the year and keep your Silca library up-to-date.

The “**Silca New Key Collection**”, the catalogue that summarizes all the new Silca keys launched in 2016, updated and published on a monthly basis, is now available and downloadable also from the Silca Electronic Catalogue.

Raccolta Nuove Chiavi

Silca ha deciso di offrirvi un ulteriore importante documento a supporto del tuo lavoro quotidiano, che ti consente di individuare velocemente, sia on line che off line, i nuovi prodotti utili al servizio duplicazione chiavi e di mantenere aggiornata la tua libreria cataloghi: la “**Raccolta Nuove Chiavi Silca**”. Questo nuovo catalogo ti aggiornerà mese dopo mese sulla totalità delle novità chiavi Silca pubblicate nel 2016, ed è da oggi disponibile e scaricabile anche dal Catalogo Elettronico.

Sammlung der neuen Schlüssel

Silca will Ihnen ein weiteres wichtiges Hilfsmittel für Ihre alltägliche Arbeit bereitstellen, dank dem Sie schnell sowohl online als auch offline die neuen Produkte finden, die für Ihren Schlüsseldienst nützlich sind und es Ihnen ermöglichen das Katalogverzeichnis kontinuierlich zu aktualisieren. Die „**Sammlung der neuen Silca-Schlüssel**“, der neue Katalog, der Sie monatlich über alle Neuheiten bei den Silca-Schlüsseln informiert, steht ab heute auch im Elektronischen Schlüsselkatalog zum Herunterladen zur Verfügung.

Collection Nouvelles Clés

Silca a dès lors décidé de vous offrir un autre document important à l'appui de votre travail quotidien qui vous permettra de repérer rapidement, on line et off line, les nouveaux produits utiles pour votre service clés et d'avoir une bibliothèque catalogues toujours à jour: la “**Collection Nouvelles Clés Silca**”. Ce catalogue vous mettra à jour mois après mois sur toutes les nouveautés clés Silca publiées en 2016, et est dès aujourd'hui proposée et téléchargeable aussi dans notre Catalogue Électronique Silca.

Colección Nuevas Llaves

Silca ha decidido ofrecerte otro documento importante para ayudarte en tu trabajo diario, que te permite localizar rápidamente (on line y off line) los nuevos productos útiles para el servicio de duplicación de llaves y mantener al día tu librería de catálogos: la “**Colección Nuevas Llaves Silca**”. Este nuevo catálogo te actualizará cada mes sobre todas las novedades llaves Silca publicadas en 2016, y a partir de hoy está disponible y te lo puedes bajar también del Catálogo Electrónico Silca.

Coleção Novas Chaves

A Silca decidiu oferecer-lhe mais um importante documento para suportar o seu trabalho quotidiano, que lhe permite individualizar rapidamente, seja online bem como offline, os novos produtos úteis para o serviço de duplicação de chaves, mantendo actualizada a sua livreria de catálogos: a “**Coleção Novas Chaves Silca**”. Este novo catálogo o atualiza mês após mês sobre todas as chaves Silca novas publicadas em 2016, e a partir de hoje está disponível e descarregável também do Catálogo Electrónico Silca.

Now available also on the Silca Electronic Key Catalogue: ekc.silca.biz

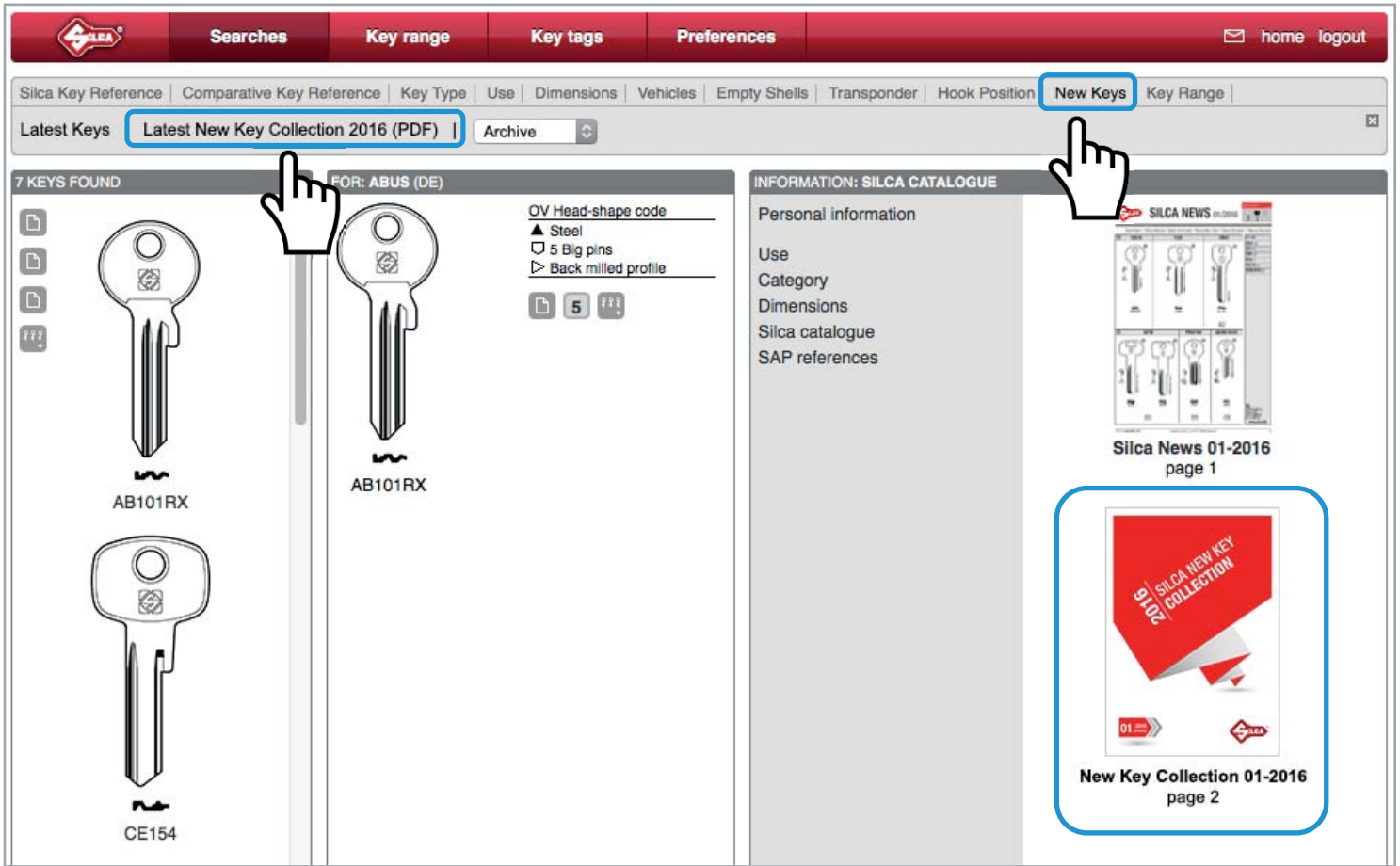

🇬🇧 New Key Collection

The online version allows you to view both all the new keys published in the current month and all the new keys published since the beginning of the year. For both search types, you can consult all the info related to every single key, or you can keep an overview format of the entire catalogue.

Download the updated version of the collection from www.silca.biz or ekc.silca.biz and replace it every month with the new issue.

🇫🇷 Collection Nouvelles Clés

La version on line vous permettra de visualiser à la fois les nouvelles clés publiées dans le mois courant ainsi que toutes les clés publiées depuis le début de l'année en cours. Pour les deux clés de parcours vous pourrez consulter toutes les informations utiles d'une seule clé ou bien d'en conserver une visualisation en format catalogue.

Téléchargez votre copie à jour de la collection sur www.silca.biz ou sur ekc.silca.biz et remplacez-la chaque mois avec la nouvelle édition.

🇮🇹 Raccolta Nuove Chiavi

La versione on line ti offre la possibilità di visualizzare sia le sole chiavi nuove pubblicate nel mese in corso sia tutte le chiavi pubblicate da inizio anno. Inoltre, per entrambe le chiavi di ricerca hai la possibilità di consultare tutte le informazioni utili a livello di chiave singola, oppure di mantenerne una visualizzazione in formato catalogo.

Scarica la tua copia aggiornata del catalogo da www.silca.biz o da ekc.silca.biz e sostituiscila ogni mese con la nuova edizione.

🇪🇸 Colección Nuevas Llaves

La versión on line te permite visualizar solamente las llaves nuevas publicadas en el mes corriente pero también todas las llaves publicadas desde principios de año. Asimismo, para ambos modos de búsqueda puedes consultar toda la información útil, relativa a nivel de llave individual, o efectuar una visualización en el formato catálogo.

Bájate tu copia actualizada de la colección del sitio www.silca.biz o de ekc.silca.biz y cámbiala cada mes por la nueva edición.

🇩🇪 Sammlung der neuen Schlüssel

In der Online-Version können Sie sowohl nur die neuen Schlüssel, die im laufenden Monat veröffentlicht werden, als auch die Schlüssel, die vom Beginn des Jahres eingeführt wurden, anzeigen. Mit beiden Suchkriterien haben Sie die Möglichkeit entweder alle nützlichen Informationen für jeden einzelnen Schlüssel oder im Katalogformat aufzurufen.

Laden Sie Ihre aktuelle Kopie von www.silca.biz oder von ekc.silca.biz herunter und ersetzen Sie sie alle Monate mit der neuen Fassung.

🇵🇹 Coleção Novas Chaves

A versão online oferece-lhe a possibilidade de visualizar apenas as chaves novas publicadas no mês em curso, bem como todas as chaves publicadas desde o início do ano. Para além disso, para ambas as pesquisas tem a possibilidade de consultar todas as informações úteis a nível de chave simples, ou de manter uma visualização em formato catálogo.

Faça o download do seu exemplar atualizado da coleção de www.silca.biz ou de ekc.silca.biz e substitua-o uma vez por mês pela nova edição.



Silca holds a seminar on automotive at the 2016 ERSI Convention

2016 ERSI Convention

15-16 April 2016 | Bologna - Savoia Hotel Regency
ITALY

Silca attends the 2016 Meeting of the Italian Locksmith and Security Expert Association (ERSI)

The annual ERSI Convention, which gathers Italian and European locksmiths and security specialists and presents the best solutions from the Security industry, is taking place in Bologna from 15 to 16 April.

The two-day programme of the conference is packed with meetings, seminars and training courses, giving the chance to the leading companies of the sector to exhibit their latest and most interesting products and solutions.

At the core of the event remains the annual meeting of the ERSI members, where associates discuss law updates and professional news from the industry.

Moreover, Silca will hold a seminar on vehicle key duplication, with a particular focus on cloning and programming devices, in the afternoon of Saturday 16 April, in Hall 1.

More details on the event in the next Silca News Bulletins.

> [More info on www.ersi.it](http://www.ersi.it)

Convegno ERSI 2016

15-16 Aprile 2016 | Bologna - Savoia Hotel Regency
ITALIA

Silca parteciperà all'edizione 2016 del Convegno ERSI (Esperti Riferme Serrature Italia)

La Convention annuale ERSI, che raduna specialisti italiani ed europei e offre il meglio del panorama delle soluzioni per la Sicurezza delle più importanti aziende del settore, avrà luogo quest'anno a Bologna dal 15 al 16 aprile.

Due giornate di intensa attività tra corsi di formazione e visite all'area espositiva dove le Aziende Partner dell'iniziativa condideranno le loro più recenti ed interessanti soluzioni in uno dei momenti formativi e di incontro più attesi dal settore.

Cuore dell'evento sarà l'Assemblea annuale in cui gli Associati ERSI si confronteranno sulle normative e sulle novità professionali legate alla loro professione.

Silca terrà inoltre un seminario sulla duplicazione delle chiavi veicolo, con focus particolare sui dispositivi di clonazione e di programmazione, nel pomeriggio di sabato 16 Aprile nella Sala 1.

Tutti i dettagli dell'evento nei prossimi Bollettini Silca News.

> [Ulteriori informazioni su www.ersi.it](http://www.ersi.it)

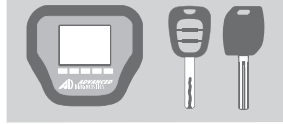

Hyundai® / Kia® Pincode Read Software Update Available on Smart Dongle Only ADS190SD - Code D745385AD

February 2016

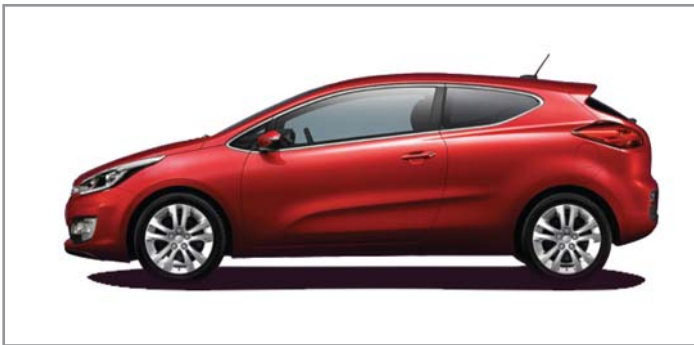

 Advanced Diagnostics are pleased to announce ADS190SD software specifically on Smart Dongle has been enhanced with **greater coverage by adding pincode reading capability via the OBD port on various Hyundai® and Kia® vehicles found worldwide.**

 Advanced Diagnostics ha sviluppato il software ADS190SD, utilizzabile esclusivamente con Smart Dongle, **per ampliare la copertura di veicoli Hyundai® e Kia® diffusi in tutto il mondo grazie alla capacità di leggerne il codice pin attraverso la presa OBD.**



 Advanced Diagnostics hat die neue Software ADS190SD entwickelt, die nur mit dem Smart Dongle eingesetzt werden kann. **ADS190SD erweitert das Angebot weltweit für die Hyundai® und Kia®-Fahrzeuge, da sie imstande ist die Pin-Codes über den OBD-Anschluss zu lesen.**

 Advanced Diagnostics a mis au point le logiciel ADS190SD, utilisable exclusivement avec Smart Dongle **pour élargir la couverture de véhicules Hyundai® et Kia® dans le monde entier car ce dispositif permet de lire le code pin à travers la prise OBD.**

 Advanced Diagnostics ha desarrollado el nuevo software ADS190SD para usarlo exclusivamente con Smart Dongle. **ADS190SD amplía la cobertura de vehículos Hyundai® y Kia®, vendidos en todo el mundo, mediante la capacidad de leer el código pin con la toma OBD.**

 A Advanced Diagnostics desenvolveu o novo software ADS190SD, utilizável exclusivamente com Smart Dongle, **para ampliar a cobertura de veículos Hyundai® e Kia® difundidos em todo o mundo, graças à capacidade de ler o seu código pin através da tomada OBD.**

DETAILS OFFER

Cable	ADC250 or ADC251
Dongle	Smart Dongle
Software category	Specials
Other software required	ADS147
Smart card	Smart Dongle







© All the brands and product names mentioned in this flyer are registered trademarks exclusive property of authorized manufacturers. Said trademarks or trade names are nominated only for the purposes of information in order to be rapidly identified.

www.silca.biz - www.silca-automotive.com - www.advanced-diagnostics.com

Hyundai® ADS190SD Software Applications

Pincode Read Software ADS190SD - used with ADS147

TABLE

								
Hyundai® Getz (Blade) Petrol 2007 to 2011	✓	✓	✓	✓	ADC250 or ADC251	Smart Dongle	✗	HYN6TE
Hyundai® Getz (Blade) Diesel 2007 to 2011	✓	✓	✓	✓	ADC250 or ADC251	Smart Dongle	✗	HYN6TE
Hyundai® i10 (Blade) Petrol 2014 Onwards	✓	✓	✓	✓	ADC250 or ADC251	Smart Dongle	✗	Not available
Hyundai® i10 (Blade) Petrol 2007 to 2013	✓	✓	✓	✓	ADC250 or ADC251	Smart Dongle	✗	HYN14TE
Hyundai® i20 (Blade) Petrol 2007 to 2014	✓	✓	✓	✓	ADC250 or ADC251	Smart Dongle	✗	TOY40BTE
Hyundai® i30 (Blade) Petrol 2007 to 2012	✓	✓	✓	✓	ADC250 or ADC251	Smart Dongle	✗	TOY40BTE
Hyundai® i30 (Blade) Diesel 2007 to 2012	✓	✓	✓	✓	ADC250 or ADC251	Smart Dongle	✗	TOY40BTE
Hyundai® iX35 (Blade) Diesel 2007 to 2015	✓	✓	✓	✓	ADC250 or ADC251	Smart Dongle	✗	TOY49TE
Hyundai® Elantra (Blade) Petrol 2007 to 2011	✓	✓	✓	✓	ADC250 or ADC251	Smart Dongle	✗	HYN14RTE

Important Note: To prevent damage to Smart Dongle, ensure that the ignition is turned off when connecting the programmer to the vehicle.

New Hyundai® /Kia® vehicles will be added to ADS190SD. To keep up to date with the latest additions - please visit Info Quest via the AD website.

Nota importante: per prevenire eventuali danni al dispositivo Smart Dongle, assicurarsi che il motore sia spento nel momento in cui il dispositivo di programmazione viene collegato al veicolo.

È prevista la copertura di ulteriori veicoli Hyundai® e Kia® utilizzando il software ADS190SD. Consulta Info Quest sul sito AD per conoscere tutti gli ultimi aggiornamenti.

Wichtige Information: Um Beschädigungen am Smart Dongle zu vermeiden, stellen Sie bitte sicher, dass die Zündung ausgeschaltet ist, wenn das Programmiergerät mit dem Fahrzeug verbunden wird.

Mit der Software ADS190SD werden weitere Hyundai® und Kia®-Fahrzeuge eingeschlossen. Im Info Quest der AD Webseite finden Sie alle Infos über die letzten Updates.

© All the brands and product names mentioned in this flyer are registered trademarks exclusive property of authorized manufacturers. Said trademarks or trade names are nominated only for the purposes of information in order to be rapidly identified.

www.silca.biz - www.silca-automotive.com - www.advanced-diagnostics.com



Kia® ADS190SD Software Applications

Pincode Read Software ADS190SD - used with ADS147

TABLE

								
Kia® Cee'd (Blade) Diesel 2007 to 2012	✓	✓	✓	✓	ADC250 or ADC251	Smart Dongle	✗	TOY40BTE
Kia® Cerato (Blade) Diesel 2007 to 2012	✓	✓	✓	✓	ADC250 or ADC251	Smart Dongle	✗	Not available
Kia® Picanto (Blade) Petrol 2007 to 2011	✓	✓	✓	✓	ADC250 or ADC251	Smart Dongle	✗	TOY40BTE
Kia® Rio (Blade) Diesel 2007 to 2011	✓	✓	✓	✓	ADC250 or ADC251	Smart Dongle	✗	HYN15TE
Kia® Rio (Blade) Petrol 2007 to 2011	✓	✓	✓	✓	ADC250 or ADC251	Smart Dongle	✗	HYN15TE
Kia® Soul (Blade) Diesel 2009 Onwards	✓	✓	✓	✓	ADC250 or ADC251	Smart Dongle	✗	HYN14TE
Kia® Sportage (Blade) Diesel 2012 Onwards	✓	✓	✓	✓	ADC250 or ADC251	Smart Dongle	✗	TOY40BTE
Kia® Sportage (Blade) Petrol 2012 Onwards	✓	✓	✓	✓	ADC250 or ADC251	Smart Dongle	✗	TOY40BTE
Kia® Venga (Blade) Petrol 2009 Onwards	✓	✓	✓	✓	ADC250 or ADC251	Smart Dongle	✗	HU134TE

Remarque importante: pour prévenir d'éventuels dégâts sur le dispositif Smart Dongle, assurez-vous que le moteur soit éteint au moment où le dispositif de programmation est connecté au véhicule.

La couverture d'autres véhicules Hyundai® et Kia® avec le logiciel ADS190SD est au programme. Consultez Info Quest sur le site AD pour connaître les dernières mises à jour.

Nota importante: para prevenir daños al dispositivo Smart Dongle, asegurarse de que el motor se haya apagado cuando el dispositivo de programación se conecta al vehículo.

Se contempla la cobertura de otros vehículos Hyundai® y Kia® con el software ADS190SD. Consulte Info Quest en el sitio web AD para conocer todas las actualizaciones más recientes.

Anotação importante: para prevenir eventuais danos no dispositivo Smart Dongle, certificar-se de que o motor está desligado no momento em que o dispositivo de programação é ligado ao veículo.

Espera-se a cobrir mais veículos Hyundai® e Kia® utilizando o software ADS190SD. Consultar Info Quest no site AD para conhecer todas as últimas atualizações.

© All the brands and product names mentioned in this flyer are registered trademarks exclusive property of authorized manufacturers. Said trademarks or trade names are nominated only for the purposes of information in order to be rapidly identified.

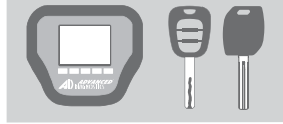



FREE Software Update for Toyota® Keys Toyota® Smart Reset (NORTH AMERICA) ADS199 - Code D745365AD

February 2016



Toyota® G or H keys can be rapidly identified thanks to the letter engraved on the blade.

 Advanced Diagnostics have released a **free update for Toyota® 2013 ADS199 software for Toyota® vehicles with a bladed G or H key in North America.** When ADS199 is used with the Smart Dongle, the 16 minute reset time is virtually eliminated. For further details on its applications refer to the Info Quest database.

 Advanced Diagnostics ha sviluppato un **nuovo aggiornamento per il software Toyota® 2013 ADS199, dedicato alle chiavi Toyota® con canna metallica di tipo G o H, diffuse in Nord America.** ADS199, utilizzato con Smart Dongle, consente di eliminare i 16 minuti di attesa precedentemente richiesti dalla procedura di cancellazione del codice della chiave. Per ulteriori dettagli consulta Info Quest.

 Advanced Diagnostics hat ein **neues Update für die Software Toyota® 2013 ADS199 entwickelt, die für Toyota®-Schlüssel der Version G oder H, die vor allem in Nordamerika in Gebrauch sind, verwendet wird.** ADS199 mit Smart Dongle ermöglicht es Ihnen die 16 Minuten Wartezeit, die bis jetzt zum Löschen des Schlüsselcodes erforderlich waren, zu sparen. Für weitere Informationen: Info Quest.

 Advanced Diagnostics a développé une **nouvelle mise à jour du logiciel Toyota® 2013 ADS199 consacré aux clés Toyota® à canon métallique du type G ou H répandues en Amérique du Nord.** ADS199, utilisé avec Smart Dongle, permet d'éliminer les 16 minutes d'attente jusqu'ici nécessaires dans la procédure d'effacement du code de la clé. Pour plus de détails, consultez Info Quest.

 Advanced Diagnostics ha desarrollado una **nueva actualización del software Toyota® 2013 ADS199, dedicado a las llaves Toyota® con caña metálica del tipo G o H, difundidas en Norteamérica.** ADS199, usado con Smart Dongle, permite eliminar los 16 minutos de espera anteriormente necesarios para el procedimiento de cancelación del código de la llave. Para más detalles: Info Quest.

 A Advanced Diagnostics desenvolveu uma **nova atualização para o software Toyota® 2013 ADS199, dedicado às chaves Toyota® com cana metálica tipo G ou H, difundidas no Norte-América.** ADS199, utilizado com Smart Dongle, permite eliminar os 16 minutos de espera anteriormente necessários para o procedimento de cancelação do código da chave. Para mais detalhes, consultar Info Quest.

DETAILS OFFER

Cable	ADC250 or ADC251
Dongle	Smart Dongle
Software category	B
Other software required	ADS125 - ADS150 - ADS174
Smart card	Smart Dongle

© All the brands and product names mentioned in this flyer are registered trademarks exclusive property of authorized manufacturers. Said trademarks or trade names are nominated only for the purposes of information in order to be rapidly identified.

www.silca.biz - www.silca-automotive.com - www.advanced-diagnostics.com

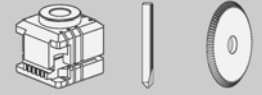

Accessories / Accessori / Zubehör / Accessoires / Accesorios / Acessórios

FOR:
PER:

YALE (EU)

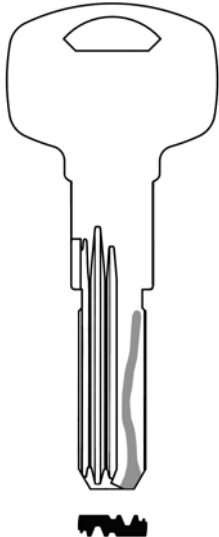

(2000 PLUS)



QUATTROCODE



TRIAX QUATTRO
TRIAX-E.CODE

OPTIONAL



CARD 4050
SN 1663

D746397ZB

Clamp R101
Morsetto R101
Spannbacke R101
Etau R101
Mordaza R101
Mordente R101

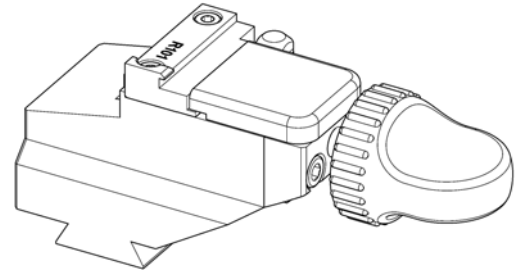

OPTIONAL

D709116ZB

Cutter H104
Fresa H104
Fräser H104
Fraise H104
Fresa H104
Fresa H104



D709241ZB

Cutter W104
Fresa W104
Fräser W104
Fraise W104
Fresa W104
Fresa W104

Starting from SKP Software version 20.8.2.54
Dalla versione Software SKP 20.8.2.54
Ab SKP Software Version 20.8.2.54
À partir du software SKP version 20.8.2.54
Desde software SKP versión 20.8.2.54
A partir da versão software SKP 20.8.2.54



SILCA NEWS 03/16

ALL THE NEW KEYS, AUTOMOTIVE SOLUTIONS, KEY CUTTING MACHINES, SOFTWARE UPDATES AND MUCH MORE

Contents

<u>New Keys</u>	1
<u>Air₄ Remotes Updates and Certifications</u>	2,3
<u>108 Catalogue Update</u>	4
<u>MySilca App New Release 1.3</u>	5,6
<u>Silca at the 2016 ELF Convention</u>	7
<u>Futura Update</u>	8
<u>Key Cutting Machine Accessories</u>	9



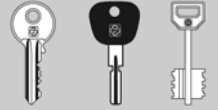

New Keys / Chiavi Nuove / Neue Schlüssel / Nouvelles Clés / Llaves Nuevas / Chaves Nuevas

FOR: PER:	ASSA	AXA	BAB	CDP	FOR / PER
	<p>ASS188</p>	<p>AX12</p>	<p>BAB36R</p>	<p>CDP1R</p>	ASSA (SE) AXA (NL) BAB (DE) CDP (NL) FAS (SE) KESO (CH) SECUREMME (IT) TRELOCK (DE)
	<p>6FS3</p>	<p>KE19</p> <p>2000 S Omega 2000 S (STEP-DRILLING)</p>		<p>TRK11DP</p> <p>RS430</p>	<div style="border: 1px solid black; padding: 5px;"> <p>01</p> <p>COMMERCIAL GROUP GRUPPO COMMERCIALE PREISEGRUPPE GROUPE COMMERCIAL GRUPO COMMERCIAL GRUPO COMERCIAL</p> <p>www.silca.biz</p> </div>

ALL THE KEYS DISPLAYED ARE AVAILABLE ALSO IN THE SILCA "NEW KEY COLLECTION"

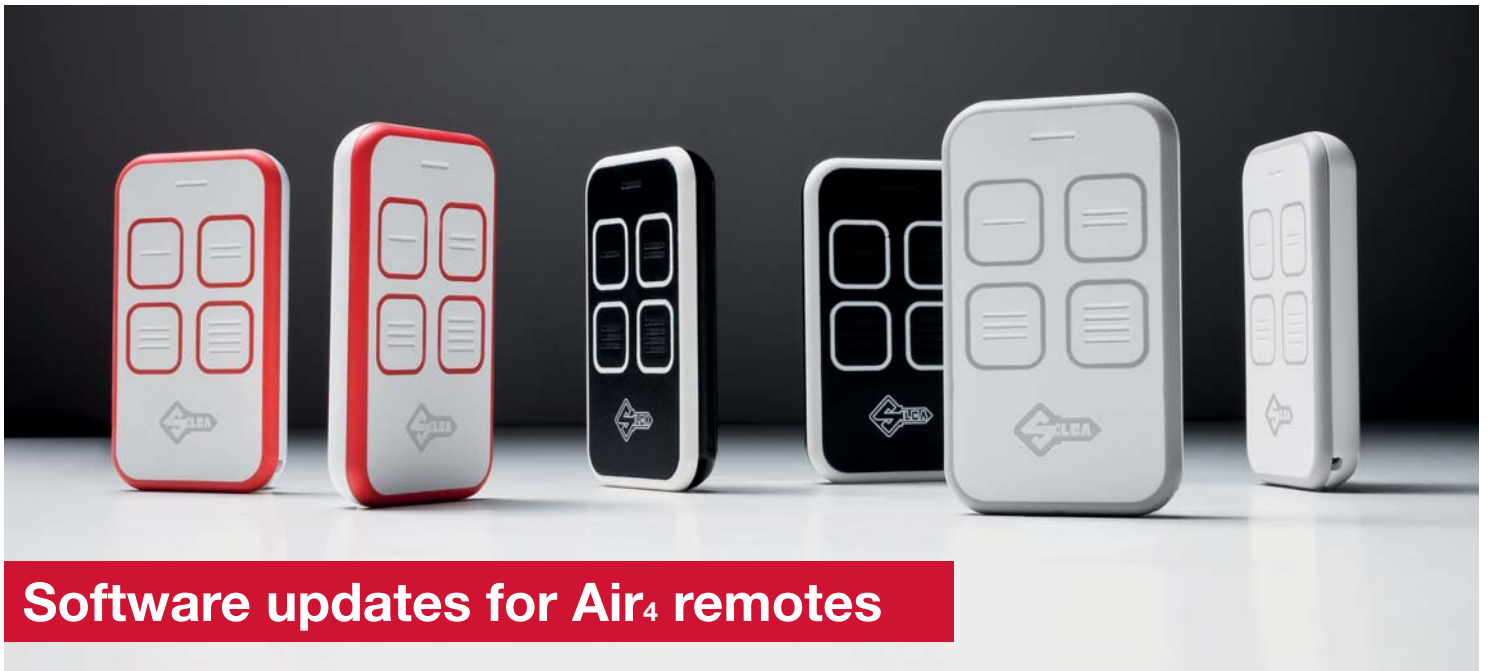

Software updates for Air4 remotes

Software updates for Air4 remotes and Easy Scan

The residential remotes Air4 and the device Easy Scan are continuously upgraded with new functions and models.

Check out the details on our website or click on the link below to download the latest version of Silca Remote Service for updating Easy Scan.

Mises à jour du logiciel des télécommandes Air4 et Easy Scan

Les télécommandes Air4 et le dispositif Easy Scan sont sans cesse remis à jour avec de nouvelles fonctions et de nouveaux modèles.

Pour plus de détails, consultez notre site ou cliquez sur le lien ci-dessous pour télécharger la dernière version de Silca Remote Service et mettre Easy Scan à jour.

Aggiornamenti software per i radiocomandi Air4 e Easy Scan

I radiocomandi residenziali Air4 e il dispositivo Easy Scan vengono continuamente aggiornati con nuove funzioni e modelli.

Consulta il nostro sito per ulteriori dettagli o clicca sul link qui sotto per scaricare l'ultima versione del Silca Remote Service e aggiornare Easy Scan.

Actualizaciones del software para los mandos Air4 y Easy Scan

Los mandos residenciales Air4 y el dispositivo Easy Scan se actualizan continuamente con funciones y modelos nuevos.

Consulta nuestro sitio para obtener otros detalles o haz clic en el enlace abajo para descargar la última versión del Silca Remote Service y actualizar Easy Scan.

Software-Updates für die Funkfernbedienung Air4 und Easy Scan

Die Funkfernbedienung im Wohnbereich Air4 und Easy Scan werden laufend mit neuen Funktionen und Modellen aktualisiert.

Besuchen Sie unsere Webseite für weitere Details oder klicken Sie auf den folgenden Link, um die letzte Version des Silca Remote Service herunterzuladen und Easy Scan zu aktualisieren.

Atualizações software para os rádio controles Air4 e Easy Scan

Os rádio controles residenciais Air4 e o dispositivo Easy Scan são atualizados de contínuo com novas funções e modelos.

Consulte o nosso site para mais detalhes ou clique no link abaixo para fazer o download da última versão do Silca Remote Service e atualizar Easy Scan.

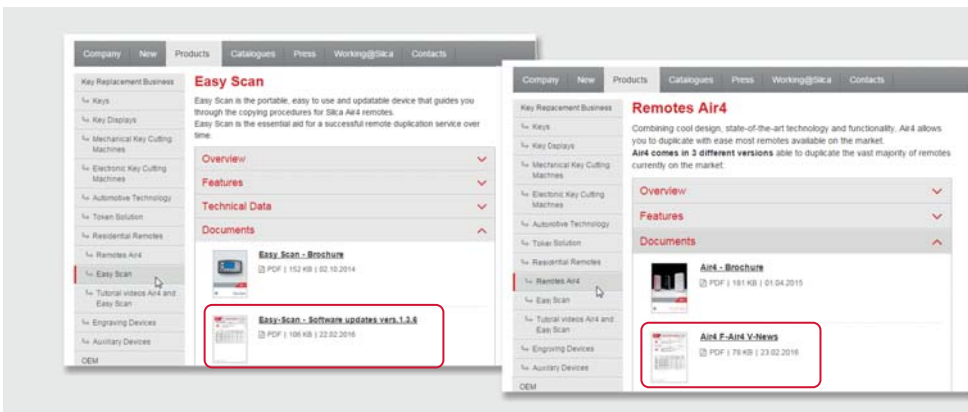

Click here to download the free upgrade of Easy Scan via Silca Remote Service

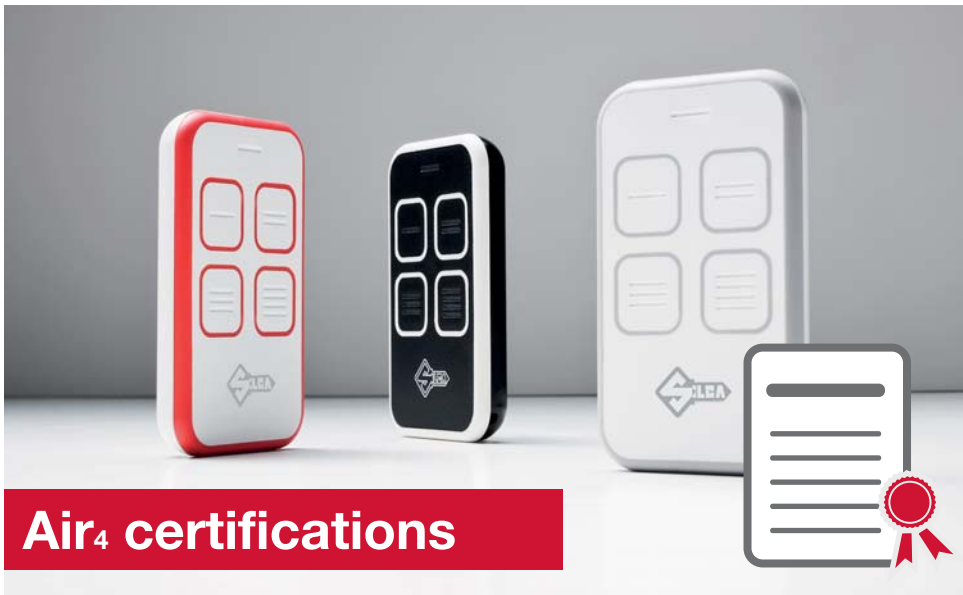

Air4 certifications

🇬🇧 Air4 remotes certifications

Air4 remotes have obtained important certifications for their quality and safety:

- the **IP64** guaranteeing complete protection from dust and splashing water;
- the **Regulatory Compliance Mark (RCM)**, which means that Air4 complies with the electrical safety and electromagnetic compatibility (EMC) legislative requirements set in Australia and New Zealand.

🇩🇪 Zertifizierungen von Air4

Die Qualitäts- und Sicherheitsstandards von Air4 werden durch die wichtigsten einschlägigen Zertifizierungen bestätigt:

- die **IP64** gewährleistet den kompletten Schutz gegen Eindringen von Staub und Spritzwasser;
- das **RCM-Kennzeichen (Regulatory Compliance Mark)** wird in Australien und Neuseeland den Produkten erteilt, die den Anforderungen der elektrischen Sicherheit und der elektromagnetischen Verträglichkeit entsprechen.

🇪🇸 Certificaciones Air4

Los mandos Air4 han obtenido certificaciones importantes que avalan los estándares elevados de calidad y seguridad:

- la **IP64** que asegura una protección completa contra polvo y salpicaduras de agua;
- la **Regulatory Compliance Mark (RCM)**, la marca usada en Australia y Nueva Zelanda para los productos que respetan determinados requisitos en materia de seguridad eléctrica y compatibilidad electromagnética.

🇮🇹 Certificazioni Air4

I radiocomandi Air4 hanno ottenuto importanti certificazioni che ne attestano gli elevati standard di qualità e sicurezza:

- la **IP64** che garantisce completa protezione contro polvere e spruzzi d'acqua;
- il **Regulatory Compliance Mark (RCM)**, marchio utilizzato in Australia e Nuova Zelanda per i prodotti che rispettano determinati requisiti in materia di sicurezza elettrica e compatibilità elettromagnetica.

🇫🇷 Certifications Air4

Les télécommandes Air4 ont obtenu d'importantes certifications qui en attestent les hauts standards qualitatifs et de sécurité:

- **IP64** qui garantit la protection totale contre la poussière et les jets d'eau ;
- **Regulatory Compliance Mark (RCM)**, certification valide en Australie et en Nouvelle Zélande pour les produits respectant des normes déterminées en matière de sécurité électrique et compatibilité électromagnétique.

🇵🇹 Certificações Air4

Os rádio controlos Air4 obtiveram importantes certificações que atestam os seus elevados padrões de qualidade e segurança:

- a **IP64** que garante proteção completa contra a poeira e os borrifos de água;
- o **Regulatory Compliance Mark (RCM)**, marca utilizada na Austrália e Nova Zelândia para os produtos que satisfazem determinados requisitos em relação à segurança elétrica e compatibilidade eletromagnética.

Customize your Air4!

🇬🇧 Customized Air4

From today you can request your customized version of Air4 remotes. Contact your distributor, sales rep or agent for more info.

🇮🇹 Air4 personalizzati

Da oggi puoi richiedere la tua versione personalizzata dei radiocomandi Air4. Contatta il tuo agente o distributore di riferimento per ulteriori informazioni.

🇩🇪 Air4 personalisiert

Jetzt können Sie Ihre individuelle Version der Funkfernbedienung Air4 bestellen. Wenden Sie sich für weitere Infos an Ihren lokalen Händler.

🇫🇷 Air4 personnalisées

Demandez dès aujourd'hui votre version des télécommandes Air4. Pour plus d'informations, contactez votre agent ou votre distributeur de confiance.

🇪🇸 Air4 personalizados

A partir de hoy puedes solicitar tu versión personalizada de los mandos Air4. Contacta a tu agente o distribuidor de referencia para recibir información adicional.

🇵🇹 Air4 personalizados

A partir de hoje pode solicitar a sua versão personalizada dos rádio controlos Air4. Contacte o seu distribuidor local ou agente de referência para mais informações.





108 Catalogue Update

🇬🇧 108 Catalogue Update

The new Catalogue 108 Update completes and updates the range of flat keys for cylinder locks, cruciform keys, lift and mailbox keys presented in the 108 Catalogue.

This catalogue includes all the new keys launched by Silca since October 2013 and a range of key references that, due to popular request, has been reinstated. These keys are easily identifiable thanks to the specific symbol used.

🇫🇷 108 Catalogue Update

Notre nouveau Catalogue 108 Update complète et met à jour la gamme de clés plates pour serrures à cylindre, clés croix, pour ascenseurs et boîtes aux lettres répertoriée dans notre Catalogue 108.

Nous recueillons dans ce catalogue toutes les nouvelles clés Silca lancées à partir d'octobre 2013 et, sur demande pressante du marché, nous avons restauré et remis en service une gamme d'articles facilement identifiables grâce au symbole utilisé.

🇮🇹 108 Catalogue Update

Il nuovo Catalogo 108 Update completa e aggiorna la gamma di chiavi piatte per serrature a cilindro, chiavi a croce, per ascensori e casellari postali già presentate nel Catalogo 108.

In questo catalogo sono raccolte tutte le nuove chiavi Silca lanciate a partire da ottobre 2013 e, a grande richiesta del mercato, è stata ripristinata e riattivata una gamma di referenze, facilmente identificabili grazie alla simbologia utilizzata.

🇪🇸 108 Catalogue Update

El nuevo Catálogo 108 Update completa y actualiza la gama de llaves planas para cerraduras de cilindro, llaves en cruz, para ascensores y casilleros postales, contenida en el Catálogo 108.

Este catálogo contiene todas las llaves nuevas de Silca, lanzadas a partir del mes de octubre de 2013 y, por una gran demanda del mercado, se ha restablecido y reactivado una gama de referencias, fácilmente identificables mediante los símbolos usados.

🇩🇪 108 Catalogue Update

Das neue Katalog 108 Update vervollständigt und aktualisiert das Sortiment der Flachschlüssel für Zylinderschlösser, der Kreuzbartschlüssel, der Fachkasten- und Liftschlüssel des Katalogs 108.

Dieser Katalog umfasst alle neuen Schlüssel, die Silca ab Oktober 2013 auf den Markt gebracht hat und aufgrund der großen Nachfrage sind auch wieder Referenzschlüssel aktiviert und eingeführt worden, die dank der verwendeten Zeichen, leicht erkennbar sind.

🇵🇹 108 Catalogue Update

O novo Catálogo 108 Update completa e actualiza a gama de chaves planas para fechaduras de cilindro, chaves tetra, para elevadores e caixas de correio já presente no Catálogo 108.

Neste catálogo estão reunidas todas as chaves Silca novas lançadas a partir de outubro de 2013 e, pelo grande pedido do mercado, foi restabelecida e reactivada uma gama de referências, que pode ser facilmente identificada graças aos símbolos utilizados.



108 Catalogue Update contents



New keys launched since October 2013



Reinstated Keys

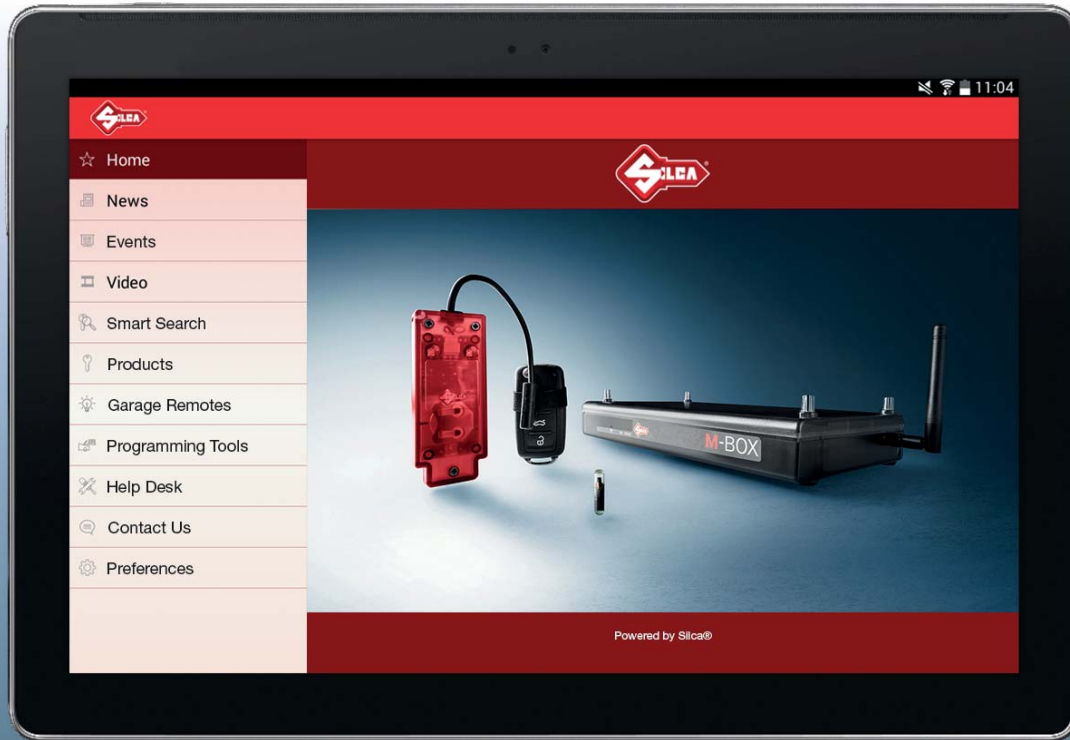

MySilca App. Release 1.3

MySilca App new release: 1.3 version

MySilca App new release will welcome you with ever-changing images and info to help you visualize at a glance all the latest Silca news.

Updates

MySilca will notify you with a pop-up alert that a new release is available for download, so you will be able to use all the functions of the app.

Nouvelle édition MySilca App version 1.3

La nouvelle édition de MySilca vous souhaitera la bienvenue avec des images et des informations toujours différentes pour savoir tout de suite quelles sont les dernières nouveautés de l'univers Silca.

Mises à jour

MySilca App vous informera des mises à jour si vous n'avez pas téléchargé la dernière édition de manière à vous permettre d'exploiter toutes les fonctions disponibles.

Nuova release MySilca App: versione 1.3

La nuova release di MySilca ti darà il benvenuto con immagini ed informazioni sempre diverse, per sapere da subito quali sono le ultime novità Silca.

Aggiornamenti

MySilca ti aggiornerà, tramite notifica pop-up, allorché tu non abbia effettuato l'aggiornamento all'ultima release disponibile così da consentirti di utilizzare tutte le funzionalità della app.

Nueva versión de MySilca App: versión 1.3

La nueva versión de MySilca te dará la bienvenida con imágenes e información siempre distintas, para saber inmediatamente cuáles son las últimas novedades del mundo Silca.

Actualizaciones

MySilca te actualizará, mediante notificación, si no has efectuado la actualización de la última versión disponible para poder usar todas las funciones de la app.

Neue Release MySilca App: Version 1.3

Das neue Release der MySilca App wird Sie mit neuen Bildern und Informationen begrüßen, um Sie immer über die Neuheiten Silca auf dem Laufenden zu halten.

Updates

MySilca App teilt Ihnen mit, wenn Sie das Update des letzten Release nicht heruntergeladen haben, damit Sie durchgehend alle verfügbaren Funktionen nutzen können.

Nova release de MySilca App: versão 1.3

A nova release de MySilca irá dar-lhe as boas vindas com imagens e informações sempre diferentes, para saber desde logo quais são as últimas novidades do mundo Silca.

Atualizações

MySilca o atualizará, por meio de notificação, caso não tenha efectuado a atualização para a última release disponível, de forma a permitir-lhe utilizar todas as funções da app.



Available for Android and iOS:
download it here



MySilca App. Release 1.3

News Section

This section has been improved with **attachments** you can view and save (feature available only on Android) to make it easier for you to get the latest Silca updates, anytime, anywhere.

Events Section

Don't miss the most important open houses, trade shows and conventions for the key cutting business. **The renovated events section gives you more info**, allowing you to access previews and relevant details for your participation in such events.

Sektion Neuheiten

Sie können jetzt die Anlagen dieser Sektion herunterladen und speichern (nur mit Android), damit Sie überall jederzeit bequem und unkompliziert auf die letzten Updates zugreifen können.

Sektion Events

Verpassen sie die Open House und die Hauptfachmessen nicht. **Jetzt erhalten Sie über diese Sektion noch mehr Informationen**, denn die Anlagen enthalten interessante Vorinformationen und Details für die Anmeldung und Teilnahme.

Sección Novedades

Una sección enriquecida ahora con **anexos**, que se pueden visualizar y guardar (solamente con Android) para que resulte todavía más cómodo y fácil consultar las últimas actualizaciones cuándo quieras y dónde quieras.

Sección Eventos

No te pierdas las Open House ni las ferias de sector más importantes. **A partir de ahora, la sección Eventos ofrece más información** al permitir visualizar anexos con vistas preliminares y detalles útiles para la participación.

Sezione Novità

Una sezione oggi arricchita da **allegati** che è possibile visualizzare e salvare (solo con Android) per rendere ancor più comodo e semplice consultare gli ultimi aggiornamenti, in qualsiasi momento e dovunque.

Sezione Eventi

Non mancare di partecipare agli Open House ed alle fiere di settore più importanti. **Da oggi la sezione eventi trasmette ancor più informazioni** grazie alla possibilità di visualizzare allegati con anteprime e dettagli utili alla partecipazione.

Section Nouveautés

Une rubrique, aujourd'hui complétée par **des attachés** que vous pourrez visualiser et sauvegarder (sur Android seulement): la consultation des dernières mises à jour à tout moment et partout sera ainsi encore plus simple et pratique.

Section Événements

Participez à l'Open House et aux foires spécialisées les plus importantes. **La rubrique événements vous informera plus amplement** dès aujourd'hui à travers la visualisation d'attachés, d'aperçus et de détails utiles pour y participer.

Seção Novidades

Uma seção hoje enriquecida por **anexos** que é possível visualizar e guardar (só com Android) para tornar ainda mais cómoda e simples a consulta das últimas atualizações, em qualquer momento e lugar.

Seção Eventos

Participe nas Open House e nas feiras mais importantes do sector. **A partir de hoje a seção eventos transmite ainda mais informações** graças à possibilidade de visualizar anexos com antevisão e detalhes úteis para a participação.

Important note: The attachments of the News and Events sections can be viewed through: Gdrive, Dropbox, your e-mail account and other apps. / **Nota importante:** Gli allegati della sezione News ed Eventi sono consultabili come: Gdrive, Dropbox, il tuo account e-mail ed altre app. / **Wichtiger Hinweis:** Die Anlagen der Sektionen Neuheiten und Events sind abrufbar in: Gdrive, Dropbox, Ihren Email-Account und weitere Apps. / **Remarque importante:** les attachés de la section Nouveautés et Événements sont consultables à travers Gdrive, Dropbox, courriel et autres app. / **Nota importante:** Los anexos de la sección Novedades y Eventos pueden consultarse como: Gdrive, Dropbox, tu cuenta de correo electrónico y otras app. / **Anotação importante:** Os anexos da seção Novidades e Eventos podem ser consultados como: Gdrive, Dropbox, o seu account e-mail e outras app.



Photo credits: www.elf2016.com

Silca attends the 2016 ELF Convention



2016 European Locksmith Federation Convention

18-22 May 2016 | Copenhagen | Radisson Blu Scandinavia Hotel København | DENMARK

> More info on elf2016.com

Silca attends the 2016 ELF Convention

Silca is attending the annual Congress of the European Locksmith Federation, taking place in Copenhagen (Denmark), from 18th to 22nd May 2016.

Come visit us at Booth 9.

Silca wird am Kongress ELF 2016 teilnehmen

Silca wird am jährlich stattfindenden Kongress des Verbandes europäischer Sicherheitsfachgeschäfte (European Locksmith Federation), der vom 18. bis 22. Mai 2016 in Copenhagen veranstaltet wird, teilnehmen. **Besuchen Sie uns am Stand 9.**

Silca asistirá al Congreso ELF 2016

Silca asistirá al Congreso anual de la Federación Europea de Cerrajería (European Locksmith Federation), que tendrá lugar en Copenhagen, del 18 al 22 de Mayo de 2016.

Ven a visitarnos en el Stand 9.

Silca participará do Congresso ELF 2016

Silca participará do congresso anual da Federação Europeia Serralheiros (European Locksmith Federation), que será realizada em Copenhagen, de 18 a 22 Maio 2016.

Venha visitar-nos no Estande 9.

Silca parteciperà al Congresso ELF 2016

Silca parteciperà al Congresso annuale della Federazione Europea Serraturieri (European Locksmith Federation), che si terrà a Copenhagen, dal 18 al 22 Maggio 2016.

Vieni a visitarci allo Stand 9.

Silca participera au Congrès ELF 2016

Silca participera au Congrès annuel de la Fédération Européenne Serruriers (European Locksmith Federation), qui se tiendra à Copenhagen, du 18 au 22 mai 2016.

Venez nous rendre visite au Stand 9.



Silca congratulates its distributor in Australia and New Zealand Locksmiths' Supply Co. on its 90th anniversary. Keep up with the good work!

SILCA FUTURA PROGRAM

Data Update with new systems

Software Vers. 2.16.0 - db 3.01

App Vers. 1.21



Futura

Data update with new systems / Aggiornamento dati con nuovi sistemi / Datenaktualisierung mit neuen Systemen / Mise à jour des données avec nouveaux systèmes / Actualización de datos con sistemas nuevos / Atualização de dados com novos sistemas

New items include / Tra le novità / Unter den Neuheiten / Parmi les nouveautés / Entre las novedades / Entre as novidades:

- | | | |
|-------------------------------|-------------------------------------|-----------------------------------|
| - Abus® EC660 | - Chicago® | - Kaba® Peaks A2
(0.150") (7P) |
| - Abus® T12 | - Dom® IXGamma
(Prf.153) (5+3+7) | - M&T® New Power
(7W-2P) |
| - Abus® T10 | - Dom® IXGamma
(Prf.155) (5+3+7) | - Medeco® KeyMark X4 |
| - Abus® Abus V65 | - Eberhard® | - Sentry® |
| - Abus® Abus V63 | - Era® | - STS® ST6 (6+5+11) |
| - Apecs® Premier CD
(7+7) | - Euro Locks® | - STS® ST8 |
| - Arco® | - Goal® D-9 (3+3+3) | - Trio-Ving® R-key |
| - BKS® WS50 - (Profile
NW) | - Honda® Motorcycle
(4T-6W) | |
| - Bommer® | | |

® are registered trademarks. / sono marchi registrati. / sind eingetragene Marken. / sont des marques déposées. / son marcas registradas. / são marcas registradas.

🇬🇧 Remember to update the Silca.apk and SilcaKeyboard.apk after installing the Software update (see the on board Instructions Manual - Ch. 7.3 APP UPDATE (apk)).

🇮🇹 Ricordarsi di aggiornare Silca.apk e SilcaKeyboard.apk dopo l'installazione dell'aggiornamento (vedi le istruzioni nel Manuale d'uso - Cap. 7.3 AGGIORNAMENTO APP (apk)).

🇩🇪 Behebt Probleme, die beim Software-Update der Maschine über das Tablet entstehen können. Für mehr Details lesen Sie die Bedienungsanleitung (Kap. 7.3 AKTUALISIERUNG APP (apk)).

🇫🇷 N'oubliez pas de mettre à jour Silca.apk et SilcaKeyboard.apk après avoir installé la mise à jour du logiciel (voir le Manuel d'instructions - Ch.7.3 MISE A JOUR APP (apk)).

🇪🇸 No olvidar actualizar Silca.apk y SilcaKeyboard.apk después de instalar la versión actualizada del programa (ver indicaciones a bordo máquina integradas en el Manual - Ch 7.3 ACTUALIZACIÓN APP (apk)).

🇵🇹 Lembrar de atualizar o Silca.apk eo SilcaKeyboard.apk após a instalação da atualização (ver as instruções no Manual de Utilização - Capítulo 7.3 ATUALIZAÇÃO APP (apk)).

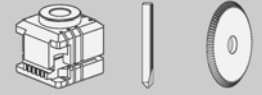
Accessories / Accessori / Zubehör / Accessoires / Accesorios / Acessórios

 FOR:
PER:

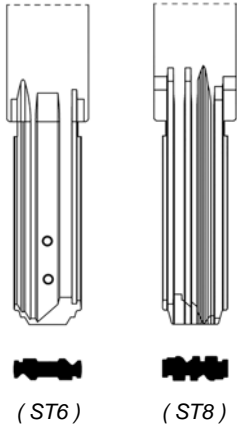
STS (ES)

SYSTEM	CARD	SN
ST6	2986	1131
ST8	3006	1151

System protected by a password issued by Silca on receipt of authorization.

Sistema protetto da password rilasciata da Silca a fronte di autorizzazione.

Passwort geschütztes System - Freigabe des Herstellers erforderlich.

Système protégé par un password qui est émis par Silca sur autorisation.

Sistema protegido por password que expide Silca contra autorización.

Sistema protegido por uma password emitida por Silca contra a autorização.

FUTURA
> SW Futura 2.16

OPTIONAL

D746544ZB

58J Jaw
Ganascia 58J
58J Backe
Mâchoire 58J
Quijada 58J
Garra 58J



OPTIONAL

D746839ZB

61J Jaw
Ganascia 61J
61J Backe
Mâchoire 61J
Quijada 61J
Garra 61J

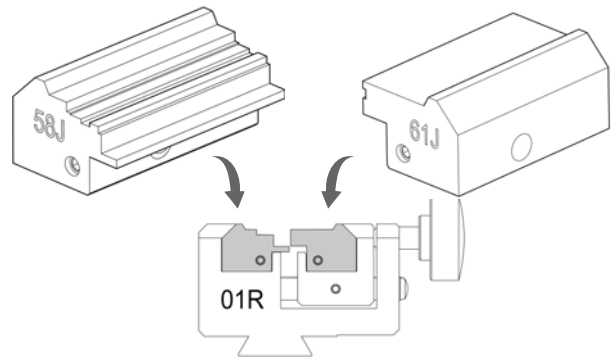

OPTIONAL

D744508ZB

Cutter 09D
Fresa 09D
Fräser 09D
Fraise 09D
Fresa 09D
Fresa 09D



SILCA NEWS 04/16

ALL THE NEW KEYS, AUTOMOTIVE SOLUTIONS, KEY CUTTING MACHINES, SOFTWARE UPDATES AND MUCH MORE

Contents

<u>New Keys</u>	<u>1</u>
<u>New Empty Shell</u>	<u>1</u>
<u>Triax Pro and Triax Pro UTP</u>	<u>2,3</u>
<u>Unocode Pro and Unocode Pro UTP</u>	<u>4,5</u>
<u>SKP Update 1/2016</u>	<u>6,7,8</u>
<u>ADS225 Software for Mazda® vehicles</u>	<u>9,10</u>

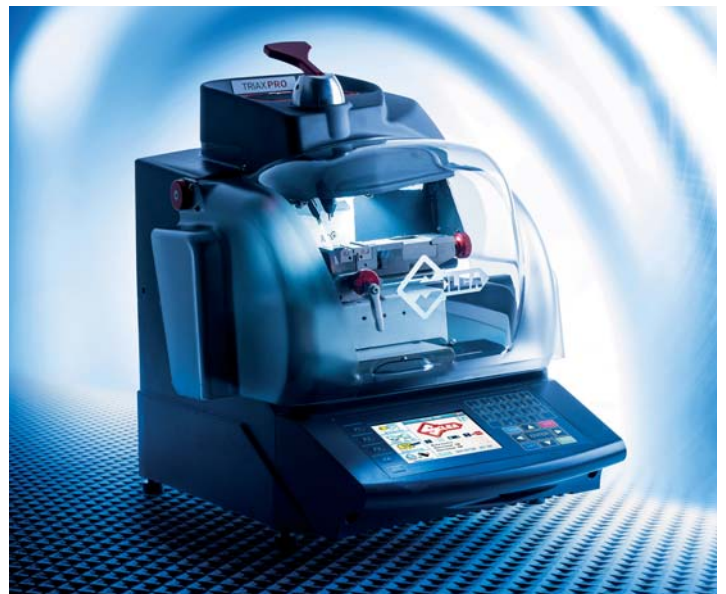

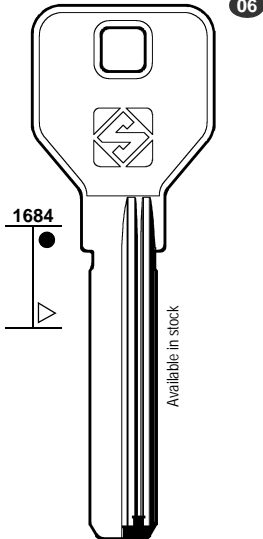
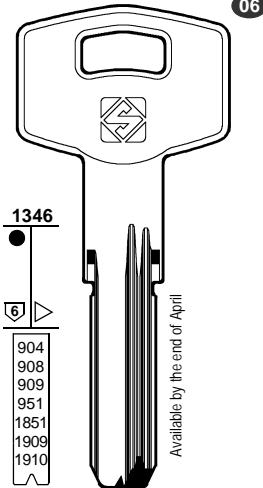

New Keys / Chiavi Nuove / Neue Schlüssel / Nouvelles Clés / Llaves Nuevas / Chaves Nuevas

FOR: PER:	CINA	DEKABA	FOR / PER
	 <p>1684</p> <p>Available in stock</p> <p>RC11</p>	 <p>1346</p> <p>Available by the end of April</p> <p>904 908 909 951 1851 1909 1910</p> <p>..... 00016-280006</p> <p>DK6X</p>	<p>CINA (CN)</p> <p>DEKABA (BG)</p> <p>01 COMMERCIAL GROUP GRUPPO COMMERCIALE PREISEGRUPPE GROUPE COMMERCIAL GRUPO COMMERCIAL GRUPO COMERCIAL</p> <p>www.silca.biz</p>

SILCA EMPTY SHELLS - NEW REFERENCES

Silca Empty Shells: **1 new key** reference to widen the existing range.

Silca Empty Shells: **1 nuova referen-za** chiavi che implementano la gamma già esistente.

Silca Empty Shells: **1 Schlüsselreferenz** die das bestehende Angebot komplementiert.

Silca Empty Shells: **1 nouvelle référence** clés qui complètent la gamme existante.

Silca Empty Shells: **1 nueva referencia** llaves que completan la gama existente.

Silca Empty Shells: **1 nova referência** chaves que implementam a gama existente.

Brand	References/Image	Specifications	Vehicle Models*				
			MODELS	YEAR FROM	YEAR TO	TRANSPONDER TYPE	TRP ID
SMART®	 <p>YM23RS1</p>	1 Button	CITY-COUPE	1998	2002		
			FORTWO	1998	2002		

* The uses of the keys are purely indicative and may be subject to updates and revisions. / Gli utilizzi delle chiavi sono da considerarsi puramente indicativi e possono essere oggetto di aggiornamenti e revisioni. / Die Abbildung und technischen Daten der Schlüssel sind nicht bindend. Silca behält sich Änderungen am Produkt, die zur Verbesserung beitragen, vor. / Les usages des clés sont purement indicatifs; ils peuvent être mis à jour et revus. / Los usos de las llaves deben considerarse puramente indicativos y pueden ser objeto de actualizaciones y revisiones. / As utilizações das chaves devem ser consideradas puramente indicativas e podem ser objecto de actualizações e revisões.

© Registered Trademarks. / © Marchi Registrati. / © Eingetragene Marken. / © Marques Déposées. / © Marcas Registradas. / © Marcas Registradas.



TRIAX PRO

TYPES OF DUPLICABLE KEYS

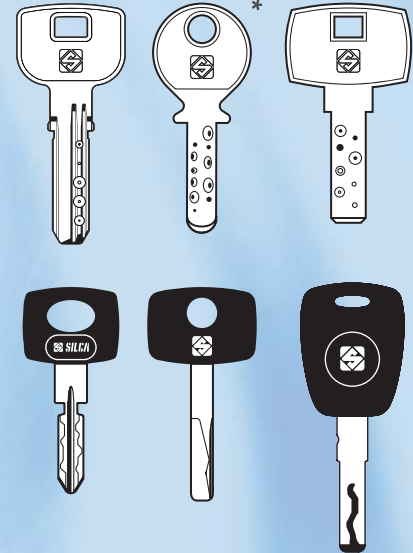

* Keys with angled cuts (cut only with R13 or R4 optional clamp).

Triax Pro

Triax Pro is the top electronic key machine for decoding and cutting either by code or from original laser and dimple keys. It also engraves keys, keyrings and small medals.

- Faster cutting cycle:
 - 30-40% for decoding laser keys
 - 15-20% for cutting laser keys
 - 10-15% for decoding dimple keys
 - 25-30% for cutting dimple keys compared with Triax Quattro.
- Adjustable cutting speed (+/- 30%).
- Cost-saving and flexible jaw system with dove tailed clamp and removable jaws.
- Quick-release tool change with lever and ergonomic handle.
- Nickel plated clamps and long-lasting hardware.
- Tools and accessories close to hand.
- User-friendly software with new features: software management of maintenance, cut keys counter, clamp calibration notice.

Triax Pro

Triax Pro è la duplicatrice elettronica top di gamma per la decodifica e la cifratura a codice o da originale di chiavi laser e punzonate e per l'incisione di chiavi, portachiavi e piccole medaglie.

- Ciclo di taglio rapido:
 - 30-40% decodifica chiavi laser
 - 15-20% cifratura chiavi laser
 - 10-15% decodifica chiavi punzonate
 - 25-30% cifratura chiavi punzonate rispetto a Triax Quattro.
- Velocità di taglio regolabile (+/- 30%).
- Sistema ganasce flessibile ed efficiente con morsetto a coda di rondine.
- Sostituzione fresino a sgancio rapido con leva a impugnatura ergonomica.
- Morsetti rivestiti in nickel e componenti hardware di lunga durata.
- Utensili e accessori a portata di mano.
- Software user-friendly con nuove funzioni: gestione della manutenzione tramite software, conteggio chiavi cifrate, notifica taratura morsetto.

Triax Pro

Triax Pro ist die elektronische Schlüsselkopiermaschinen zum Decodieren und Fräsen nach Code oder nach Original von Bahnen- und Bohrmuldenschlüsseln und zum Gravieren von Schlüsseln, Schlüsselanhängern und kleinen Plaketten.

- Kürzere Fräszeiten:
 - 30-40% beim Decodieren der Bahnschlüssel
 - 15-20% beim Fräsen der Bahnschlüssel
 - 10-15% beim Decodieren der Bohrmuldenschlüssel
 - 25-30% beim Fräsen der Bohrmuldenschlüssel im Vergleich zur Triax Quattro.
- Einstellbare Fräsgeschwindigkeit (+/- 30%).
- Flexibles und effizientes Spannbackensystem mit austauschbaren Spannbacken.
- Austausch des Fräasers mit Schnellkupplung und ergonomischem Hebel.
- Vernickelte Spannbacken und Hardwarekomponenten mit langer Lebensdauer.
- Werkzeuge und Zubehör sind griffbereit.
- Benutzerfreundliche Software mit neuen Funktionen: Softwaregestütztes Wartungsmanagement, Zähler der gefrästen Schlüssel, Kalibrierung der Spannbacke.

> [More info on all Silca websites](#)



Work station for key cutting

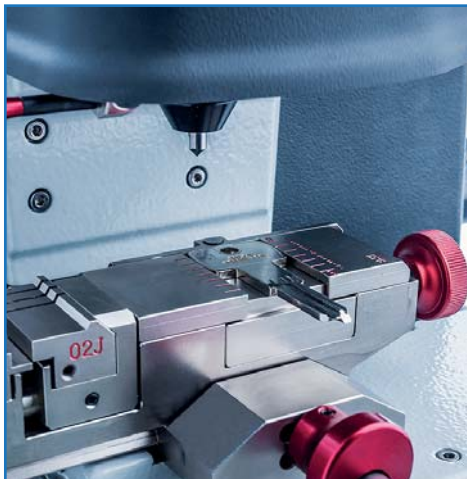

Work station for engraving



Optimized cutter change system

Triax Pro

Triax Pro est la machine haut de gamme pour décoder une clé originale et reproduire au code ou en copie les clés à points ou à vagues, et pour graver des têtes de clés, de porte-clés et de petites médailles.

- Cycle de taillage rapide:
 - 30-40% décodage clés laser
 - 15-20% taillage clés laser
 - 10-15% décodage clés à points
 - 25-30% taillage clés à points par rapport à Triax Quattro.
- Vitesse de taillage réglable (+/- 30%).
- Système mâchoires flexible et efficace avec étau à forme de queue-d'aronde.
- Remplacement de la fraise rapide avec levier à prise en main ergonomique.
- Étaux revêtus de nickel et composants hardware de longue durée.
- Outils et accessoires à portée de la main.
- Logiciel convivial avec nouvelles fonctions: gestion de la maintenance par logiciel, compteur des clés taillées, notification d'étalonnage de l'étau.

Triax Pro

Triax Pro é a duplicadora eletrônica topo de gama para a descodificação e o corte por código ou do original de chaves laser e de pontos e para a gravação de chaves, porta-chaves e pequenas medalhas.

- Ciclo de corte rápido:
 - 30-40% descodificação chaves laser
 - 15-20% corte chaves laser
 - 10-15% descodificação chaves de pontos
 - 25-30% corte chaves de pontos em relação a Triax Quattro.
- Velocidade de corte regulável (+/- 30%).
- Sistema de garras flexível e eficiente com mordente em rabo de andorinha.
- Substituição da fresa de desengate rápido com alavanca com pega ergonômica.
- Mordentes revestidos com níquel e componentes hardware de longa duração.
- Ferramentas ao alcance da mão.
- Software user-friendly com novas funções: gestão da manutenção através de software, contagem das chaves cortadas, notificação do ajuste do mordente.

Triax Pro

Triax Pro es la duplicadora electrónica top de la gama para descodificar y cortar por código o por copia original de llaves de regata y de seguridad, y para grabar llaves, llaveros y medallas pequeñas.

- Ciclo de corte rápido:
 - 30-40% descodificación llaves de regata
 - 15-20% corte llaves de regata
 - 10-15% descodificación llaves de seguridad
 - 25-30% corte llaves de seguridad respecto de Triax Quattro.
- Velocidad de corte regulable (+/- 30%).
- Sistema flexible y eficiente de pletinas con mordaza a cola de milano.
- Sustitución fresa mediante desenganche rápido con palanca ergonómica.
- Mordazas revestidas con níquel y componentes hardware de larga duración.
- Herramientas al alcance de la mano.
- Software fácil de usar con nuevas funciones: gestión del mantenimiento mediante software, contador de llaves cortadas, notificación calibración de la mordaza.

OPTIONAL CLAMPS FOR ANGLED CUTS

Two optional tilting clamps for angled cuts (+/- 45°) ensure top quality performances with high speed cutting cycles:

- the motorized R13 clamp,
- the manual R4 clamp.

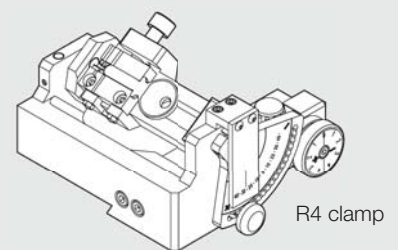

R4 clamp

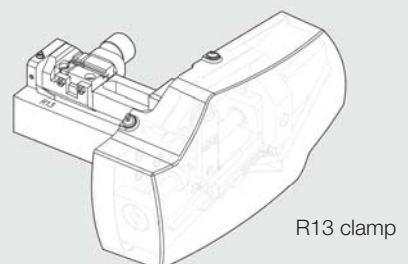

R13 clamp

> [More info on all Silca websites](#)



UNOCODE PRO

TYPES OF DUPLICABLE KEYS



* Keys cut with specific optional accessories.

Unocode Pro

Unocode Pro is the top electronic key cutting machine for decoding and cutting either by code or from original flat cylinder, vehicle keys and cruciform keys.

- Faster cutting cycle:
 - 10% for decoding cylinder keys
 - 25-30% for cutting cylinder keys compared with Unocode 399 Evo.
- Adjustable cutting speed (+/- 30%).
- Long-lasting cutter with AlCrN (aluminum chromium nitride) coating.
- Quiet and stable thanks to the reinforced structure of the machine.
- Four-sided, nickel plated clamps with system for easier rotation and ergonomic handle.
- Incorporated pull-out swarf tray on the side of the machine.
- Tools and accessories close to hand.
- User-friendly software with new features: software management of maintenance, cut keys counter.

Unocode Pro

Unocode Pro è la duplicatrice elettronica top di gamma per la decodifica e la cifratura a codice o a copia di chiavi piatte per cilindri e veicoli e di chiavi a croce.

- Ciclo di taglio rapido:
 - 10% decodifica chiavi cilindro
 - 25-30% cifratura chiavi cilindro rispetto a Unocode 399 Evo.
- Velocità di taglio regolabile (+/- 30%).
- Fresa di lunga durata rivestita in alcrona (AlCrN - nitrato di cromo alluminio).
- Silenziosa e stabile grazie alla struttura rinforzata della macchina.
- Morsetti a quattro lati, rivestiti in nickel, con sistema rapido di rotazione e manopola ergonomica.
- Vaschetta raccogli-trucioli estraibile a bordo macchina.
- Utensili e accessori a portata di mano.
- Software user-friendly con nuove funzioni: gestione della manutenzione tramite software, conteggio chiavi cifrate.

Unocode Pro

Unocode Pro ist die führende elektronische Schlüsselkopiermaschine zum Decodieren und Fräsen nach Code oder Original von Flachschlüsseln für Zylinder und Fahrzeuge, sowie von Kreuzbartschlüsseln.

- Kürzere Fräszeiten:
 - 10% beim Decodieren der Zylinderschlüssel
 - 25-30% beim Fräsen der Zylinderschlüssel im Vergleich zur Unocode 399 Evo.
- Einstellbare Fräsgeschwindigkeit (+/- 30%).
- Fräser mit langer Lebensdauer mit AlCrN-Beschichtung.
- Verstärkte Fräserwelle zur Reduzierung der Geräusche und für eine höhere Stabilität.
- Vierseitige Spannbacken mit Nickelbeschichtung, Schnellkupplung und ergonomischem Griff.
- Eingebaute, ausziehbare Auffangwanne, um die Späne leicht zu sammeln.
- Werkzeuge und Zubehör sind griffbereit.
- Benutzerfreundliche Software mit neuen Funktionen: Softwaregestütztes Wartungsmanagement, Zähler der gefrästen Schlüssel.

> [More info on all Silca websites](#)



Unocode Pro

Unocode Pro est la machine électronique haut de gamme permettant de décoder une clé originale et de reproduire au code ou en copie des clés plates pour cylindres et véhicules, et des clés cruciformes.

- Cycle de taillage rapide:
 - 10% décodage clés pour cylindres
 - 25-30% taillage clés pour cylindres par rapport à Unocode 399 Evo.
- Vitesse de taillage réglable (+/- 30%).
- Fraise longue durée avec revêtement en AlCrN (nitru de d'aluminium chrome).
- Silencieuse et stable grâce au support de la fraise renforcé.
- Étaux à quatre faces avec revêtement en nickel, système de mise en place rapide pour une rotation facile et poignées ergonomiques.
- Cuvette de copeaux extractible.
- Outils et accessoires à portée de la main.
- Logiciel convivial avec nouvelles fonctions: gestion de la maintenance par logiciel, compteur des clés taillées.

Unocode Pro

Unocode Pro es la duplicadora electrónica top de la gama para la descodificación y el corte por código o por copia de llaves planas para cilindros, vehículos y de llaves cruciformes.

- Ciclo de corte rápido:
 - 10% descodificación llaves cilindro
 - 25-30% corte llaves cilindro respecto de Unocode 399 Evo.
- Velocidad de corte regulable (+/- 30%).
- Fresa de larga duración con revestimiento de AlCrN (nitruro de cromo aluminio)
- Silenciosa y estable gracias al soporte de la fresa reforzado.
- Mordazas de cuatro lados con revestimiento de níquel, sistema de cambio rápido facilitado por la rotación y mando ergonómico.
- Bandeja de virutas extraíble.
- Herramientas al alcance de la mano.
- Software fácil de usar con nuevas funciones: gestión del mantenimiento mediante software, contador de llaves cortadas.

Unocode Pro

Unocode Pro é a máquina duplicadora eletrônica topo de gama para a descodificação e o corte por código ou do original de chaves planas para cilindros e de chaves tetra.

- Ciclo de corte rápido:
 - 10 % descodificação chaves cilindro
 - 25-30% corte chaves cilindro em relação a Unocode 399 Evo.
- Velocidade de corte regulável (+/- 30%).
- Fresa de longa duração com revestimento de AlCrN (nitreto de cromo alumínio).
- Silenciosa e estável graças ao suporte da fresa reforçado.
- Mordentes de quatro lados com revestimento em níquel, sistema de rotação rápida e manípulo ergonómico.
- Tabuleiro para limalhas extraível.
- Ferramentas ao alcance da mão.
- Software user-friendly com novas funções: gestão da manutenção através de software, contagem das chaves cortadas.

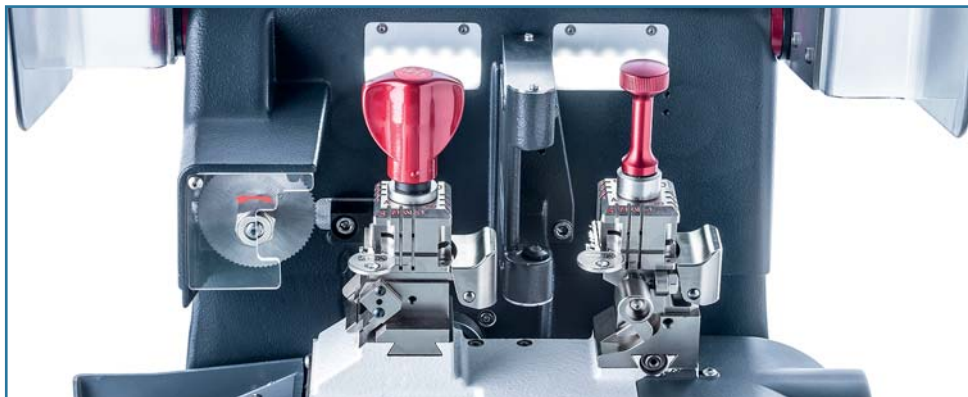

Key cutting station with AlCrN coated cutter



Four-sided, nickel plated clamps



Tool tray with anti-slip mat

OPTIONAL TOOLS AND ACCESSORIES

- The automatic feeder saves time and effort in cutting single sided flat keys.
- The optional rotating V1 clamp enables you to operate also on the third axis for angled cuts. Together with other dedicated accessories, it allows you to duplicate Abloy®, Abus®, Ava®-Chubb®, Chubb®, Ford® and Luma® type keys.

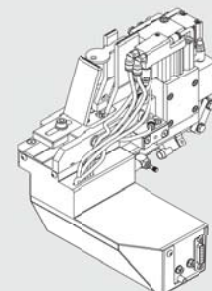

Automatic feeder

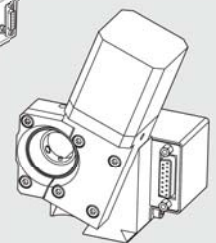

Rotating V1 clamp

© are registered trademarks.

> More info on all Silca websites



Silca Key Programs

Update 1/2016 - SKP Vers. 21.0.x.xx

UPDATE 1/2016

New Silca Key Programs 1/2016 Update for all WEB and DVD subscribers available in the "News" section of Silca Key Programs.

Discover all the updates for Silca Code Program, Silca Triax - Quattrocode Program and Silca Viper Program.

AGGIORNAMENTO 1/2016

Nuovo Aggiornamento Silca Key Programs 1/2016 per tutti gli abbonati WEB e DVD consultabile nella sezione "Novità" di Silca Key Programs.

Scopri tutti gli aggiornamenti per Silca Code Program, Silca Triax - Quattrocode Program e Silca Viper Program.

AKTUALISIERUNG 1/2016

Die Informationen zur neuen Aktualisierung des Silca Key Programs 1/2016 für alle WEB und DVD Abonnenten ist in der Sektion "Neuheiten" des Silca Key Programs verfügbar.

Entdecken Sie die Aktualisierungen für Silca Code Program, Silca Triax - Quattrocode Program und Silca Viper Program.

MISE À JOUR 1/2016

Nouvelle mise à jour Silca Key Programs 1/2016 pour tous les abonnés WEB et DVD disponible dans la section "Nouveautés" de Silca Key Programs.

Découvrez toutes les mises à jour pour Silca Code Program, Silca Triax - Quattrocode Program et Silca Viper Program.

ACTUALIZACIÓN 1/2016

Nueva actualización Silca Key Programs 1/2016 para todos los abonados WEB y DVD disponible en la sección "Novedades" de Silca Key Programs.

Descubra todas las actualizaciones para Silca Code Program, Silca Triax - Quattrocode Program y Silca Viper Program.

ATUALIZAÇÃO 1/2016

Nova atualização Silca Key Programs 1/2016 para todos o assinantes WEB e DVD disponível na seção "Novidades" de Silca Key Programs.

Descubra todas as atualizações para Silca Code Program, Silca Triax - Quattrocode Program e Silca Viper Program.

> [More info on all Silca websites](#)

SILCA CODE PROGRAM

Data Update with 22 new cutting cards

SKP Vers. 21.0.x.xx



Unocode 199



Unocode 299/399



Unocode 399 Evo



Unocode Pro

Data update with 22 new cutting cards / Aggiornamento dati con 22 nuove schede / Datenaktualisierung mit 22 neuen Karten / Mise à jour des données avec 22 nouvelles fiches / Actualización datos con 22 fichas nuevas / Atualização de dados com 22 fichas novas.

New items include / Tra le novità / Unter den Neuheiten / Parmi les nouveautés / Entre las novedades / Entre as novidades:

- Abus® T10
- Abus® T12
- Abus® V65
- Abus® V63
- Arco®
- Assa® (Profile AS-PN-US-HN-NK-GM-PM- PK-SH)
- Chicago®
- Eberhard®
- Era®
- Euro Locks®
- Kaba® Peaks A2 (0.150") (7P)
- Medeco® KeyMark X4
- Trio-Ving® R-key



Update the software on / Aggiornare il software di / Aktualisierung der Software von / Mettre à jour le logiciel de / Actualizar el software de / Atualizar o software de: UC199, UC299, UC399, UC399 Evo, Unocode Pro.

SILCA VIPER PROGRAM

Data Update with 7 new cutting cards

SKP Vers. 21.0.x.xx



Viper

Data update with 7 new cutting cards / Aggiornamento dati con 7 nuove schede / Daten-Aktualisierung mit 7 neuen Karten / Mise à jour des données avec 7 nouvelles fiches / Actualización datos con 7 fichas nuevas / Atualização de dados com 7 fichas novas.

New items include / Tra le novità / Unter den Neuheiten / Parmi les nouveautés / Entre las novedades / Entre as novidades:

- Abus® V65
- Abus® V63
- Honda® Motorcycle (4T-6W)
- Market TAIWAN



Update the software on / Aggiornare il software di / Aktualisierung der Software von / Mettre à jour le logiciel de / Actualizar el software de / Atualizar o software de: VIPER.

SILCA TRIAX - QUATTROCODE PROGRAM

Data Update with 20 new cutting cards

SKP Vers. 21.0.x.xx



Quattrocode



Triax e-code



Triax Quattro



Triax Pro

Data update with 20 new cutting cards / Aggiornamento dati con 20 nuove schede / Daten-Aktualisierung mit 20 neuen Karten / Mise à jour des données avec 20 nouvelles fiches / Actualización datos con 20 fichas nuevas / Atualização de dados com 20 fichas novas.

New items include / Tra le novità / Unter den Neuheiten / Parmi les nouveautés / Entre las novedades / Entre as novidades:

- **Abus**® EC660
- **Apecs**® Premier CD (7+7)
- **Eurospec**® D51 Cable Lock
- **Eurospec**® D54 Chain Lock
- **Eurospec**® D69 Padlock
- **Eurospec**® D74 U Lock
- **Goal**® D-9 (3+3+3)
- **Honda**® Motorcycle (4T-6W)
- **M&T**® New Power (7W-2P)
- **Nissan**® Emergency Key (5+5+4)
- **Tonyon**® TY340-STZ52-STB24-KB23 (4T-5W)
- **Wilka**® P2
- **Wilka**® P3Q
- **Wilka**® PR300Q
- **Winkhaus**® On-tra (EGS)
- **Yale**® 2000 Plus Series (5+5)



Update the software on / Aggiornare il software di / Aktualisierung der Software von / Mettre à jour le logiciel de / Actualizar el software de / Atualizar o software de: Triax e-code, Triax Quattro, Triax Pro.



New Software Release for Mazda® vehicles ADS225 - Code D745347AD

April 2016



 Advanced Diagnostics are pleased to announce the release of Mazda® ADS225 key programming software for Mazda® vehicles worldwide.

ADS225 software programs proximity keys with push button start for selected Mazda® vehicles. This software allows keys to be added or programmed from a lost key situation. The software has been designed to bypass the pincode automatically in the background, making it a seamless process when programming keys.

 Advanced Diagnostics ha sviluppato il nuovo software Mazda® ADS225 per la programmazione di chiavi veicolo per modelli Mazda® diffusi in tutto il mondo.

Il software ADS225 programma chiavi di prossimità per una serie di veicoli Mazda® dotati di pulsante di accensione/spengimento. Questo software permette di aggiungere o programmare una chiave anche nel caso in cui l'originale sia andata persa. Il software è stato progettato per bypassare il codice pin, letto automaticamente in background.

 Advanced Diagnostics hat die neue Software Mazda® ADS225 zum Programmieren von Autoschlüsseln der weltweit verbreiteten Mazda®-Modelle entwickelt.

Die Software ADS225 programmiert Keyless-Go Schlüssel für Mazda®-Fahrzeuge mit Start/Stop-Taste. Diese Software ermöglicht das Hinzufügen oder Programmieren von Schlüsseln auch wenn der Originalschlüssel verloren gegangen ist. Die Software wurde so konzipiert, dass kein Pin-Code eingegeben werden muss, da dieser automatisch im Hintergrund gelesen wird.

 Advanced Diagnostics ha desarrollado el nuevo software Mazda® ADS225 para la programación de llaves de vehículos de modelos Mazda® comercializados en todo el mundo.

El software ADS225 permite programar las llaves de proximidad de los modelos Mazda® equipados con el botón START/STOP. Este software permite añadir llaves y programar llaves en el caso de pérdida total. El software se ha diseñado para poder saltarse la seguridad del vehículo de forma automática durante el proceso de programación de las llaves.

 Advanced Diagnostics a développé le nouveau logiciel Mazda® ADS225 pour programmer les clés véhicule pour des modèles Mazda® dans le monde.

Le logiciel ADS225 programme les clés de proximité pour une série de véhicules Mazda® dotés de bouton d'allumage/extinction. Ce logiciel permet d'ajouter ou de programmer une clé même quand on a perdu la clé originale; il a été conçu pour contourner le code pin, lu automatiquement en background.





 A Advanced Diagnostics desenvolveu o novo software Mazda® ADS225 para a programação de chaves para veículo para modelos Mazda® presentes em todo o mundo.

O software ADS225 programa chaves de proximidade para uma série de veículos Mazda® providos de botão para ligar/desligar o motor. Este software permite adicionar ou programar chaves também no caso de perda da chave original. O software foi projectado para omitir o código pin, lido automaticamente em background.

Software Applications

Mazda® ADS225

TABLE

							
CX - 5 (Proximity) 2013 to 2016	✓	✓	✗	✗	ADC250 or ADC251	G or Smart Dongle	✗
Mazda® 6 (Proximity) 2014 to 2016	✓	✓	✗	✗	ADC250 or ADC251	G or Smart Dongle	✗
Mazda® 3 (Proximity) 2014 to 2016	✓	✓	✗	✗	ADC250 or ADC251	G or Smart Dongle	✗
Mazda® 2 (Proximity) 2014 to 2016	✓	✓	✗	✗	ADC250 or ADC251	G or Smart Dongle	✗

Important note: To prevent damage to Smart Dongle, ensure that the ignition is turned off when connecting the programmer to the vehicle.

Nota importante: per prevenire eventuali danni al dispositivo Smart Dongle, assicurarsi che il motore sia spento nel momento in cui il dispositivo di programmazione viene collegato al veicolo.

Wichtiger Hinweis: um mögliche Schäden am Smart Dongle zu vermeiden, verbinden Sie das Programmiergerät nur bei ausgeschaltetem Motor an das Fahrzeug.

Remarque importante: pour prévenir d'éventuels dégâts sur le dispositif Smart Dongle, assurez-vous que le moteur soit éteint au moment où le dispositif de programmation est connecté au véhicule.

Nota importante: para prevenir cualquier daño al Smart Dongle, asegúrese de que el contacto está apagado cuando conecte el dispositivo de programación al vehículo.

Anotação importante: para prevenir eventuais danos no dispositivo Smart Dongle, certificar-se de que o motor está desligado no momento em que o dispositivo de programação é ligado ao veículo.

OFFER DETAILS

Cable	ADC250 or ADC251
Dongle	G or Smart Dongle
Software category	A
Other software required	ADS133
Smart card	Yes or Smart Dongle

© All the brands and product names mentioned in this flyer are registered trademarks exclusive property of authorized manufacturers. Said trademarks or trade names are nominated only for the purposes of information in order to be rapidly identified.

www.silca.biz - www.silca-automotive.com - www.advanced-diagnostics.com



SILCA NEWS 05/16

ALL THE NEW KEYS, AUTOMOTIVE SOLUTIONS, KEY CUTTING MACHINES, SOFTWARE UPDATES AND MUCH MORE

Contents

<u>New Keys</u>	1-2
<u>Silca ID48 Application Introduction</u>	3
<u>Updated Vehicle Guide Legend</u>	4-8
<u>Vehicle Keys Guide</u>	9-16
<u>Flash 008</u>	17
<u>ADC219 Cable - ADS230 Software</u>	18-21
<u>Futura Program Update</u>	22
<u>MySilca App 1.3 Version</u>	23
<u>Silca @ ERSI 2016</u>	24





New Keys / Chiavi Nuove / Neue Schlüssel / Nouvelles Clés / Llaves Nuevas / Chaves Nuevas

FOR: PER:	CES	EVVA	WILKA	FOR / PER
	<p>Available by the end of May</p> <p>CE155</p>	<p>Available by the end of May</p> <p>EV118X</p>	<p>Available by the end of May</p> <p>WK91R</p>	CES (DE) EVVA (AT) WILKA (DE)
	<p>Available by the end of May</p> <p>J 1-1200 M 1-1200</p> <p>DWO4CTE</p>			CHEVROLET DAEWOO (KR)
	<p>Available by the end of May</p> <p>M 1-1200</p> <p>DWO6BTE</p>			
	<p>Available in stock</p> <p>R 1-1706</p> <p>HON65RTE</p>			HONDA (JP)
				01 COMMERCIAL GROUP GRUPPO COMMERCIALE PREISEGRUPPE GROUPE COMMERCIAL GRUPO COMMERCIAL GRUPO COMERCIAL www.silca.biz

ALL THE KEYS DISPLAYED ARE AVAILABLE ALSO IN THE SILCA "NEW KEY COLLECTION"



New Keys / Chiavi Nuove / Neue Schlüssel / Nouvelles Clés / Llaves Nuevas / Chaves Nuevas

FOR / PER
HUF (DE)
NEIMAN (DE) (F)
SSANGYONG (KR)
WITTE (DE)

FOR: PER:			HUF		
 P254 49 50 Available in stock AH 1-8154 AH 1001-9282 HU49RTE	 P254 49 50 Available in stock AH 1-8154 AH 1001-9282 HU70TE	 P254 S83 Available in stock 1-6700 HU116TE			

FOR: PER:	NEIMAN	SSANGYONG	WITTE
 P272 S47 Available by the end of May 1/2/3/4/5 V 1-12295 NE66TE	 P455 Available in stock SSY4RTE	 P254 49 50 Available in stock HV 1-8154 HV 1001-9282 WT9TE	

01
 COMMERCIAL GROUP
 GRUPPO COMMERCIALE
 PREISEGRUPPE
 GROUPE COMMERCIAL
 GRUPO COMMERCIAL
 GRUPO COMERCIAL

www.silca.biz

ALL THE KEYS DISPLAYED ARE AVAILABLE ALSO IN THE SILCA "NEW KEY COLLECTION"



SILCA ID48

THE COMPLETE CLONING SOLUTION









Updated vehicle guide legend
and vehicle application list

> For more info visit the Automotive Technology Section on all Silca websites



Vehicle Guide Legend / Legenda Guida Veicoli / Fahrzeugschlüssel Erläuterung Légende Guide Véhicules / Leyenda Guía para Vehículos / Legenda Guia para Veículos

	<p>Make and model Marca e modello Marke und Modell Marque et modèle Marca y modelo Marca e modelo</p>
<p>FROM</p> 	<p>In production from... Fabbricata dal... Hergestellt seit... Fabriquée à partir du... Fabricada desde... Fabricada desde...</p>
<p>TO</p> 	<p>In production until... Fabbricata fino al... Hergestellt bis... Fabriquée jusqu'au... Fabricada hasta... Fabricada até...</p>
<p> SILCA REF.</p>	<p>Silca key reference Referenza chiave Silca Silca-Schlüssel-Referenz Référence clé Silca Referencia llave Silca Referência chave Silca</p>
<p> "TE" SILCA REF.</p>	<p>Silca TE key reference Referenza chiave Silca TE Silca TE Schlüssel-Referenz Référence clé Silca TE Referencia llave Silca TE Referência chave Silca TE</p>
<p> "FLIP KEYS" SILCA REF.</p>	<p>Silca Flip Key reference Referenza Chiave Flip Silca Silca Klappschlüssel-Referenz Référence Clé Flip Silca Referencia Llave Plegable Silca Referência Chave Flip Silca</p>
	<p>Type of transponder on the original key (1) Tipo di transponder presente nella chiave originale (1) Transpondertyp im Originalschlüssel (1) Type de transpondeur présent dans la clé originale (1) Tipo de transponder presente en la llave original (1) Tipo de transponder presente na chave original (1)</p>

<p>TRANS. COPY</p> 	<p>Indicates the transponder to be used to copy the original key. Indica il transponder da utilizzare per copiare la chiave originale. Zeigt den Transponder, der verwendet wird, um den Originalschlüssel kopieren zu können. Indique le transpondeur à être utilisé pour copier la clé originale. Indica el transpondedor que debe ser utilizado para copiar la llave original. Indica o transponder para ser utilizado para copiar a chave original.</p>
<p>TRANS. PROGR.</p> 	<p>Indicates the transponder to be used for programming through diagnostic device. Indica il transponder da utilizzare per programmazione tramite dispositivo diagnostico. Zeigt den Transponder für die Programmierung durch Diagnosevorrichtung verwendet werden. Indique le transpondeur à être utilisé pour la programmation à travers dispositif diagnostique. Indica el transpondedor que debe ser utilizado para la programación por medio del dispositivo de diagnóstico. Indica o transponder para ser utilizado para a programação por meio de dispositivo de diagnóstico.</p>
<p>GEN.</p>  <p>GTI COMPATIBLE</p>	<p>Indicates the possibility to generate a crypto transponder code on GTI transponder using TRP SETTING program with RW4 + P-BOX, FAST COPY + P-BOX, RW4 PLUS and FAST COPY PLUS devices. Indica la possibilità di generare il codice per transponder crypto su transponder GTI utilizzando il programma TRP SETTING con i dispositivi RW4 + P-BOX, FAST COPY + P-BOX, RW4 PLUS e FAST COPY PLUS. Zeigt die Möglichkeit an, den Code für Transponder Crypto auf dem Transponder GTI unter Verwendung des Programm TRP SETTING mit den Geräten RW4 + P-BOX, FAST COPY + P-BOX, RW4 PLUS und FAST COPY PLUS zu generieren. Indique qu'il est possible de générer le code pour transpondeur crypto sur transpondeur GTI en utilisant le programme TRP SETTING sur les dispositifs RW4 + P-BOX, FAST COPY + P-BOX, RW4 PLUS et FAST COPY PLUS. Indica la posibilidad de generar el código para transponder crypto en el transponder GTI utilizando el programa TRP SETTING con los dispositivos RW4 + P-BOX, FAST COPY + P-BOX, RW4 PLUS y FAST COPY PLUS. Indica a capacidade de gerar o código para transponders crypto no transponders GTI utilizando o programa TRP SETTING usando os dispositivos RW4 + P-BOX, FAST COPY + P-BOX, RW4 PLUS e FAST COPY PLUS.</p>



Vehicle Guide Legend / Legenda Guida Veicoli / Fahrzeugschlüssel Erläuterung Légende Guide Véhicules / Leyenda Guía para Vehículos / Legenda Guia para Veículos

Copy of key by FAST COPY PLUS / RW4 PLUS

The symbols show:

- **Y:** Can be copied with FAST COPY PLUS / RW4 PLUS;
- **M-BOX:** Can be copied with FAST COPY PLUS + M-BOX / RW4 PLUS + M-BOX;
- **RD:** You must first identify the key to know if it can be copied or not;
- **ID:** The FAST COPY PLUS / RW4 PLUS is able to duplicate the ID (part of the electronic code) of Philips* Crypto transponders.

Copia della chiave tramite FAST COPY PLUS / RW4 PLUS
I simboli identificano:

- **Y:** Copiabile con FAST COPY PLUS / RW4 PLUS;
- **M-BOX:** Copiabile con FAST COPY PLUS + M-BOX / RW4 PLUS + M-BOX;
- **RD:** Indica che è necessario leggere la chiave per sapere se questa è duplicabile o no;
- **ID:** FAST COPY PLUS / RW4 PLUS è in grado di duplicare l'identificatore (parte del codice elettronico) del transponder Crypto Philips*.

Kopie des Schlüssels mit FAST COPY PLUS / RW4 PLUS
Die Symbole zeigen an:

- **Y:** Kopierbar mit FAST COPY PLUS / RW4 PLUS;
- **M-BOX:** Kopierbar mit FAST COPY PLUS + M-BOX / RW4 PLUS + M-BOX;
- **RD:** Zeigt an, dass der Schlüssel gelesen werden muss, um festzustellen, ob er kopierbar ist oder nicht;
- **ID:** FAST COPY PLUS / RW4 PLUS kopiert den Identifikator (Teil des elektronischen Codes) des Transponders Crypto Philips*.

Copie de la clé par FAST COPY PLUS / RW4 PLUS
Les symboles indiquent:

- **Y:** Copiable avec FAST COPY PLUS / RW4 PLUS;
- **M-BOX:** Copiable avec FAST COPY PLUS + M-BOX / RW4 PLUS + M-BOX;
- **RD:** Indique qu'il faut lire la clé pour savoir si elle est reproductible ou pas;
- **ID:** FAST COPY PLUS / RW4 PLUS est en mesure de reproduire l'identificateur (partie du code électronique) du transpondeur Crypto Philips*.

Copia de la llave por medio de FAST COPY PLUS / RW4 PLUS
Los símbolos identifican:

- **Y:** Copiable con FAST COPY PLUS / RW4 PLUS;
- **M-BOX:** Copiable con FAST COPY PLUS + M-BOX / RW4 PLUS + M-BOX;
- **RD:** Indica que es necesario leer la llave para saber si ésta es duplicable o no;
- **ID:** FAST COPY PLUS / RW4 PLUS es capaz de duplicar el identificador (parte del código electrónico) del transponder Crypto Philips*.

Cópia da chave por meio de FAST COPY PLUS / RW4 PLUS
Os símbolos identificam:

- **Y:** Pode ser copiada com FAST COPY PLUS / RW4 PLUS;
- **M-BOX:** Pode ser copiada com FAST COPY PLUS + M-BOX / RW4 PLUS + M-BOX;
- **RD:** Indica que é necessário ler a chave para saber se ela pode ou não ser duplicada.
- **ID:** FAST COPY PLUS / RW4 PLUS pode duplicar o identificador (parte do código electrónico) do transponder Crypto Philips*.

Copy of key by FAST COPY / RW4

The symbols show:

- **Y:** Can be copied with FAST COPY / RW4;
- **P-BOX:** Can be copied with FAST COPY + P-BOX / RW4 + P-BOX;
- **M-BOX:** Can be copied with FAST COPY+P-BOX+M-BOX / RW4+P-BOX+M-BOX;
- **RD:** You must first identify the key to know if it can be copied or not;
- **ID:** The FAST COPY / RW4 is able to duplicate the ID (part of the electronic code) of Philips* Crypto transponders.

Copia della chiave tramite FAST COPY / RW4
I simboli identificano:

- **Y:** Copiabile con FAST COPY / RW4;
- **P-BOX:** Copiabile con FAST COPY + P-BOX / RW4 + P-BOX;
- **M-BOX:** Copiabile con FAST COPY+P-BOX+M-BOX / RW4+P-BOX+M-BOX;
- **RD:** Indica che è necessario leggere la chiave per sapere se questa è duplicabile o no;
- **ID:** FAST COPY / RW4 è in grado di duplicare l'identificatore (parte del codice elettronico) del transponder Crypto Philips*.

Kopie des Schlüssels mit FAST COPY / RW4
Die Symbole zeigen an:

- **Y:** Kopierbar mit FAST COPY / RW4;
- **P-BOX:** Kopierbar mit FAST COPY + P-BOX / RW4 + P-BOX;
- **M-BOX:** Kopierbar mit FAST COPY+P-BOX+M-BOX / RW4+P-BOX+M-BOX;
- **RD:** Zeigt an, dass der Schlüssel gelesen werden muss, um festzustellen, ob er kopierbar ist oder nicht;
- **ID:** FAST COPY / RW4 kopiert den Identifikator (Teil des elektronischen Codes) des Transponders Crypto Philips*.

Copie de la clé par FAST COPY / RW4
Les symboles indiquent:

- **Y:** Copiable avec FAST COPY / RW4;
- **P-BOX:** Copiable avec FAST COPY + P-BOX / RW4 + P-BOX;
- **M-BOX:** Copiable avec FAST COPY+P-BOX+M-BOX / RW4+P-BOX+M-BOX;
- **RD:** Indique qu'il faut lire la clé pour savoir si elle est reproductible ou pas;
- **ID:** FAST COPY / RW4 est en mesure de reproduire l'identificateur (partie du code électronique) du transpondeur Crypto Philips*.

Copia de la llave por medio de FAST COPY / RW4
Los símbolos identifican:

- **Y:** Copiable con FAST COPY / RW4;
- **P-BOX:** Copiable con FAST COPY + P-BOX / RW4 + P-BOX;
- **M-BOX:** Copiable con FAST COPY+P-BOX+M-BOX / RW4+P-BOX+M-BOX;
- **RD:** Indica que es necesario leer la llave para saber si ésta es duplicable o no;
- **ID:** FAST COPY / RW4 es capaz de duplicar el identificador (parte del código electrónico) del transponder Crypto Philips*.

Cópia da chave por meio de FAST COPY / RW4
Os símbolos identificam:

- **Y:** Pode ser copiada com FAST COPY / RW4;
- **P-BOX:** Pode ser copiada com FAST COPY + P-BOX / RW4 + P-BOX;
- **M-BOX:** Pode ser copiada com FAST COPY+P-BOX+M-BOX / RW4+P-BOX+M-BOX;
- **RD:** Indica que é necessário ler a chave para saber se ela pode ou não ser duplicada.
- **ID:** FAST COPY / RW4 pode duplicar o identificador (parte do código electrónico) do transponder Crypto Philips*.

COPY



FAST COPY PLUS
RW4 PLUS



COPY









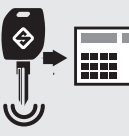





FAST COPY
RW4



Vehicle Guide Legend / Legenda Guida Veicoli / Fahrzeugschlüssel Erläuterung Légende Guide Véhicules / Leyenda Guía para Vehículos / Legenda Guia para Veículos

 ID FAST COPY RW4 FAST COPY PLUS RW4 PLUS	<p>Identification of transponder type by FAST COPY / FAST COPY PLUS / RW4 / RW4 PLUS (2) (4)</p> <p>Identificazione tipo di transponder tramite FAST COPY / FAST COPY PLUS / RW4 / RW4 PLUS (2) (4)</p> <p>Identifizierung des Transpondertyps mit Hilfe der FAST COPY / FAST COPY PLUS / RW4 / RW4 PLUS (2) (4)</p> <p>Identification du type de transpondeur par FAST COPY / FAST COPY PLUS / RW4 / RW4 PLUS (2) (4)</p> <p>Identificación tipo de transponder por medio de FAST COPY / FAST COPY PLUS / RW4 / RW4 PLUS (2) (4)</p> <p>Identificação do tipo de transponder por meio de FAST COPY / FAST COPY PLUS / RW4 / RW4 PLUS (2) (4)</p>
 ID FAST COPY RW4	<p>Identification of transponder type by FAST COPY / RW4 (2) (4)</p> <p>Identificazione tipo di transponder tramite FAST COPY / RW4 (2) (4)</p> <p>Identifizierung des Transpondertyps mit Hilfe der FAST COPY / RW4 (2) (4)</p> <p>Identification du type de transpondeur par FAST COPY / RW4 (2) (4)</p> <p>Identificación tipo de transponder por medio de FAST COPY / RW4 (2) (4)</p> <p>Identificação do tipo de transponder por meio de FAST COPY / RW4 (2) (4)</p>
 STP	<p>Indicates the possibility to generate codes for new transponder keys using STP + RW2 or STP + RW3 or STP + RW4 or STP + FAST COPY or STP + RW4 PLUS or STP + FAST COPY PLUS (5)</p> <p>Indica la possibilità di generare il codice per nuove chiavi transponder utilizzando STP + RW2 oppure STP + RW3 oppure STP + RW4 oppure STP + FAST COPY oppure STP + RW4 PLUS oppure STP + FAST COPY PLUS (5)</p> <p>Zeigt an, dass der Code für neue Transponderschlüssel mit dem STP + RW2 oder STP + RW3 oder STP + RW4 oder STP + FAST COPY oder STP + RW4 PLUS oder STP + FAST COPY PLUS generiert werden kann (5)</p> <p>Indique la possibilité de générer le code pour de nouvelles clés transpondeur en utilisant STP + RW2 ou STP + RW3 ou STP + RW4 ou STP + FAST COPY ou STP + RW4 PLUS ou STP + FAST COPY PLUS (5)</p> <p>Indica la posibilidad de generar el código para nuevas llaves transponder utilizando STP + RW2 o STP + RW3 o STP + RW4 o STP + FAST COPY o STP + RW4 PLUS o STP + FAST COPY PLUS (5)</p> <p>Indica a possibilidade de gerar o código para novas chaves transponder utilizando STP + RW2 ou STP + RW3 ou STP + RW4 ou STP + FAST COPY ou STP + RW4 PLUS ou STP + FAST COPY PLUS (5)</p>

  	<p>Door lock Portiera Türe Portière Puerta Porta</p> <p>Antitheft device for motorcycles Antifurto per ciclomotori e motociclette Diebstahlschutz für Motorrad und Motorräder Anti-vol pour cyclomoteurs et motocyclettes Antihurto para ciclomotores y motocicletas Anti-roubo para scooters e motocicletas</p>
 	<p>Boot / Hatchback Bagagliaio / Portiera posteriore Kofferraum / Hecktür Coffre / Portière postérieure Maletero / Puerta trasera Bagageira / Porta traseira</p> <p>Cycle seat Sella Sattel Selle Silla Selim</p>
	<p>Petrol cap Tappo benzina Benzintankverschluss Bouchon réservoir Tapa de gasolina Tampão de gasolina</p>
	<p>Vehicle drawer Cassetto Schublade Tiroir Gaveta Porta-luvas</p>
    	<p>All the following information reported in columns 6, 42+71, 72, 43/44a, 12, 15 regard car/motorcycle/truck ignition.</p> <p>Tutti i simboli e le informazioni contenute nelle colonne 6, 42+71, 72, 43/44a, 12, 15 sono relative all'accensione dell'auto/motocicletta/camion.</p> <p>Alle Symbole und Informationen in den Spalten 6, 42+71, 72, 43/44a, 12, 15 beziehen sich auf die Zündung des Autos/Motorrads/LKW.</p> <p>Tous les symboles et les informations reportées dans les colonnes 6, 42+71, 72, 43/44a, 12, 15 sont relatifs à l'allumage de la voiture/motocyclette/camion.</p> <p>Todos los símbolos y las informaciones en las columnas 6, 42+71, 72, 43/44a, 12, 15 son relativas al encendido del coche/motocicleta/camion.</p> <p>Todos os símbolos e as informações contidas nas colunas 6, 42+71, 72, 43/44a, 12, 15 dizem respeito à ignição de carro/motocicleta/camião.</p>



Vehicle Guide Legend / Legenda Guida Veicoli / Fahrzeugschlüssel Erläuterung Légende Guide Véhicules / Leyenda Guía para Vehículos / Legenda Guia para Veículos

(1)	<p>"PH" Transponder Philips*</p> <p>"PH / CR" Transponder Philips* Crypto</p> <p>"PH / CR2" Transponder Philips* Crypto 2</p> <p>"PH / CR3" Transponder Philips* Crypto 3</p> <p>"MEG" Transponder Megamos*</p> <p>"MEG / CR" Transponder Megamos* Crypto</p> <p>"SOK / CR" Sokymat* Crypto</p> <p>"TEXAS" Transponder Texas*</p> <p>"TEX / CR" Transponder Texas* Crypto</p> <p>"TEX / CR2" Transponder Texas* Crypto 2</p> <p>"TEX / MA" Transponder Texas* Crypto mutual authentication</p> <p>"TEMIC" Transponder Temic*</p> <p>"MOTOROLA" Transponder Motorola*</p> <p>"TEM / CR" Transponder Temic* Crypto</p> <p>"SAAB" Transponder Saab*</p>
(2)	<p>ID TRANSPONDER - FAST COPY PLUS / RW4 PLUS / FAST COPY / RW4</p> <p>11 Temic* (Fiat* - fixed code) (Fiat* - codice fisso) (Fiat* - Fixer Code) (Fiat* - code fixe) (Fiat* - código fijo) (Fiat* - código fijo)</p> <p>12 Temic* (Mazda* - fixed code) (Mazda* - codice fisso) (Mazda* - Fixer Code) (Mazda* - code fixe) (Mazda* - código fijo) (Mazda* - código fijo)</p> <p>13 Megamos* (fixed code) (codice fisso) (Fixer Code) (code fixe) (código fijo) (código fijo)</p> <p>17 Silca (fixed code - empty) (codice fisso - vuoto) (silca Fixer Code - leer) (fixe code - vide) (código fijo - vacío) (código fijo - vacío)</p> <p>21 Silca (fixed code - empty) (codice fisso - vuoto) (silca Fixer Code - leer) (fixe code - vide) (código fijo - vacío) (código fijo - vacío)</p> <p>22 Silca (fixed code - empty) (codice fisso - vuoto) (silca Fixer Code - leer) (fixe code - vide) (código fijo - vacío) (código fijo - vacío)</p> <p>23 Silca (fixed code - empty) (codice fisso - vuoto) (silca Fixer Code - leer) (fixe code - vide) (código fijo - vacío) (código fijo - vacío)</p> <p>33 Philips* (read/write - fixed code) (read/write - codice fisso) (read/write - Fixer Code) (read/write - code fixe) (read/write - código fijo) (read/write - código fijo)</p> <p>40 Philips* Crypto (Opel*-Vauxhall*)</p> <p>41 Philips* Crypto (Nissan*)</p> <p>42 Philips* Crypto (VAG*)</p> <p>44 Philips* Crypto</p> <p>45 Philips* Crypto (Peugeot*)</p> <p>46 Philips* Crypto 2</p> <p>47 Philips* Crypto 3</p>

(2)	<p>ID TRANSPONDER - FAST COPY PLUS / RW4 PLUS / FAST COPY / RW4</p> <p>48 Megamos* Crypto</p> <p>48-A Megamos* Crypto (Chevrolet - Daewoo)</p> <p>48-K Megamos* Crypto (Kia)</p> <p>49 Philips* Crypto 3</p> <p>50 Philips* Crypto 3</p> <p>53 Philips* (emulation of Megamos* for Audi*) (emulazione di Megamos* per Audi*) (simuliert Megamos* für Audi*) (émulation de Megamos* pour Audi*) (emulación de Megamos* para Audi*) (emulação de Megamos* para Audi*)</p> <p>73 Philips* (multi block - fixed code) (multi blocco - codice fisso) (multi block - Fixer Code) (multi bloc - code fixe) (multi bloque - código fijo) (multi bloco - código fijo)</p> <p>93 Philips* (emulation of Megamos* for Daewoo*) (emulazione di Megamos* per Daewoo*) (simuliert Megamos* für Daewoo*) (émulation de Megamos* pour Daewoo*) (emulación de Megamos* para Daewoo*) (emulação de Megamos* para Daewoo*)</p> <p>4C Texas* (fixed code) (codice fisso) (Fixer Code) (code fixe) (código fijo) (código fijo)</p> <p>4D Texas* Crypto</p> <p>4F Philips* Crypto (Fiat* - Alfa Romeo*)</p> <p>4M Philips* Crypto (Mitsubishi*)</p> <p>4W Philips* Crypto (VAG*)</p> <p>6A Texas* Crypto 3</p> <p>6E Texas* Crypto (with mutual authentication) (con mutua autenticazione) (mit gegenseitiger Authentisierung) (par authentication réciproque) (con autenticación mutua) (com autenticação mútua)</p> <p>6F Texas* Crypto 2</p> <p>8C Temic* Crypto</p> <p>8D Saab* (not duplicable) (non duplicabile) (nicht kopierbar) (non reproducible) (no duplicable) (não pode ser duplicado)</p> <p>8E Sokymat* Crypto</p> <p>88 Megamos* Crypto 2</p> <p>48-A1 Megamos* Crypto Volkswagen*</p> <p>48-A2 Megamos* Crypto Audi*</p> <p>48-A3 Megamos* Crypto Seat*</p> <p>48-A4 Megamos* Crypto Škoda*</p>
------------	--



Vehicle Guide Legend / Legenda Guida Veicoli / Fahrzeugschlüssel Erläuterung Légende Guide Véhicules / Leyenda Guía para Vehículos / Legenda Guia para Veículos

(4) ID TRANSPONDER TEXAS CRYPTO (4D)

- 60 Texas* Crypto (generic) (generico) (nicht spezifiziert) (générique) (genérico) (genérico)
- 61 Texas* Crypto Mitsubishi* 3
- 62 Texas* Crypto Mitsubishi* 2
- 63 Texas* Crypto Ford* 2
- 64 Texas* Crypto (Renault* < 2000, Chrysler*, Jeep*)
- 65 Texas* Crypto (Suzuki*)
- 66 Texas* Crypto (Suzuki* 2)
- 67 Texas* Crypto (Toyota* / Lexus*)
- 68 Texas* Crypto (Toyota* / Lexus* 2)
- 69 Texas* Crypto (Yamaha*)
- 70 Texas* Crypto (Toyota* EU)
- 71 Texas* Crypto (Suzuki* Cycles)
- 72 Texas* Crypto (Kawasaki* Cycles)
- XX Texas* Crypto (new or generic) (nuovo o generico) (neu oder nicht spezifiziert) (nouveau ou générique) (nuevo o genérico) (novo ou genérico)

- (5) **"MEG"** Megamos* (type of generation) (tipo di generazione) (Erzeugung Typ) (type de génération) (tipo de generación) (tipo de geração)
- "B - F"** Bosch* - Fiat* (type of generation) (tipo di generazione) (Erzeugung Typ) (type de génération) (tipo de generación) (tipo de geração)
- "S - O"** Siemens* - Opel* (type of generation) (tipo di generazione) (Erzeugung Typ) (type de génération) (tipo de generación) (tipo de geração)
- "M - V"** Megamos* - VDO* (type of generation) (tipo di generazione) (Erzeugung Typ) (type de génération) (tipo de generación) (tipo de geração)
- "T - F"** Temic* - Fiat* (type of generation) (tipo di generazione) (Erzeugung Typ) (type de génération) (tipo de generación) (tipo de geração)
- "S - V"** Siemens* - Volkswagen* (type of generation) (tipo di generazione) (Erzeugung Typ) (type de génération) (tipo de generación) (tipo de geração)
- "G - V"** PSA* - Valeo* (type of generation) (tipo di generazione) (Erzeugung Typ) (type de génération) (tipo de generación) (tipo de geração)
- "G - C"** PSA* - CPH* (type of generation) (tipo di generazione) (Erzeugung Typ) (type de génération) (tipo de generación) (tipo de geração)
- "N - N"** Nissan* (type of generation) (tipo di generazione) (Erzeugung Typ) (type de génération) (tipo de generación) (tipo de geração)

The keys must then be memorized in the vehicle central immobilizer system.
 Le chiavi devono poi essere memorizzate nella centralina immobilizer dell'auto.
 Die Schlüssel müssen anschliessend in die Steuerzentrale der Wegfahrsperre des Autos eingespeichert werden.
 Les clés doivent être mises en mémoire dans le central immobiliseur du véhicule.
 Las llaves deben memorizarse en la centralita immobilizer del vehículo.
 A seguir as chaves devem ser memorizadas na central do sistema de imobilização do veículo.

(*) IMPORTANT NOTE

The trade-marks or trade names mentioned in our catalogue are the exclusive property of authorized manufactures of lock and users, they are nominated only for the purposes of information so that any lock for which our keys are made can be rapidly identified.

I marchi o le denominazioni citate sono di proprietà esclusiva dei fabbricanti di serrature e degli utilizzatori autorizzati, e sono indicati a titolo di semplice informazione, con lo scopo di riconoscere velocemente a quali serrature le nostre chiavi sono destinate.

Die angeführten Markennamen oder Handelsmarken sind ausschließliches Eigentum der Schloßhersteller und zugelassenen Fachhändlern, und sind nur zur Information angeführt, mit dem Zweck, schnell erkennen zu können, zu welchem Schloß unsere Schlüssel passen.

Les marques et appellations commerciales citées dans notre catalogue appartiennent exclusivement aux fabricants de serrures et aux utilisateurs autorisés, elles sont indiquées à titre d'information pure et simple pour vous permettre de déterminer rapidement les serrures auxquelles nos clés sont destinées.

















Las marcas y denominaciones comerciales citadas en nuestro catálogo se declaran de propiedad exclusiva de los fabricantes de cerraduras y los utilizadores autorizados, se citan por simple información, al objeto de hacer comprender sin dificultad a qué cerraduras van destinadas nuestras llaves.

As marcas e as denominações citadas são propriedade exclusiva dos fabricantes de fechaduras e dos utilizadores autorizados, e são indicadas apenas a título de informação, a fim de reconhecer rapidamente as fechaduras a que se destinam as nossas chaves.



Car Keys Guide / Guida Chiavi Auto / Marktführer für Autoschlüssel / Guide Clés pour Voitures
 Guía Llaves para Coches / Guia Chaves para Carros

New Updates

1	2	2a	3	3a	3b	E3 / E4 / E2			6	42+71	72	43 44a	12
						TRANSPONDER INFO				IGNITION			
													
CAR MAKE MODEL	FROM	TO	SILCA REF.	SILCA REF.	SILCA REF.	TRANSP. COPY	TRANSP. PROGR.	GEN. ON GTI	TRANSP. TYPE	FAST COPY PLUS RW4 PLUS FAST COPY / RW4	FAST COPY PLUS RW4 PLUS	FAST COPY RW4 + P-BOX/M-BOX	STP
													

For more info on the uses of car keys, refer to the Silca Electronic Key Catalogue:



ALFA ROMEO®

GT	2003	2010	SIP22MH	SIP22TE	SIP22FH	T48			MEG / CR	48	M-BOX	P-BOX,M-BOX	
147	2000	2010	SIP22MH	SIP22TE	SIP22FH	T48			MEG / CR	48	M-BOX	P-BOX,M-BOX	
156	2003	2007	SIP22MH	SIP22TE	SIP22FH	T48			MEG / CR	48	M-BOX	P-BOX,M-BOX	

AUDI®

ALLROAD	2000	2005	HU66MH	HU66TE	HU66FH	T48			MEG / CR	48	M-BOX	P-BOX,M-BOX	
ALLROAD	2006	2011	HU66MH	HU66TE	HU66FH	T48			MEG / CR	48-A2	M-BOX	P-BOX,M-BOX	
A1	2010	2015	HU66MH	HU66TE	HU66FH	T48			MEG / CR	48-A2	M-BOX	P-BOX,M-BOX	
A2	2000	2005	HU66MH	HU66TE	HU66FH	T48			MEG / CR	48	M-BOX	P-BOX,M-BOX	
A3	1996	2003	HU66MH	HU66TE	HU66FH	T48			MEG / CR	48	M-BOX	P-BOX,M-BOX	
A3	2003	2012	HU66MH	HU66TE	HU66FH	T48			MEG / CR	48-A2	M-BOX	P-BOX,M-BOX	
A4	1997	2004	HU66MH	HU66TE	HU66FH	T48			MEG / CR	48	M-BOX	P-BOX,M-BOX	
A6	1997	2004	HU66MH	HU66TE	HU66FH	T48			MEG / CR	48	M-BOX	P-BOX,M-BOX	
A6	2004	2006	HU66MH	HU66TE	HU66FH	T48			MEG / CR	48-A2	M-BOX	P-BOX,M-BOX	
A8	1997	2004	HU66MH	HU66TE	HU66FH	T48			MEG / CR	48	M-BOX	P-BOX,M-BOX	
CABRIO	1997	2004	HU66MH	HU66TE	HU66FH	T48			MEG / CR	48	M-BOX	P-BOX,M-BOX	
COUPÉ S2	1997	2004	HU66MH	HU66TE	HU66FH	T48			MEG / CR	48	M-BOX	P-BOX,M-BOX	
S3	2001	2004	HU66MH	HU66TE	HU66FH	T48			MEG / CR	48	M-BOX	P-BOX,M-BOX	
S4	2002	2005	HU66MH	HU66TE	HU66FH	T48			MEG / CR	48	M-BOX	P-BOX,M-BOX	
S6	1997	2004	HU66MH	HU66TE	HU66FH	T48			MEG / CR	48	M-BOX	P-BOX,M-BOX	
S8	1998	2004	HU66MH	HU66TE	HU66FH	T48			MEG / CR	48	M-BOX	P-BOX,M-BOX	
TT	2006	2014	HU66MH	HU66TE	HU66FH	T48			MEG / CR	48-A2	M-BOX	P-BOX,M-BOX	

CHEVROLET USA®

COLORADO	2008	2012	TOY43RMH	TOY43RATE	TOY43RFH	T48			MEG / CR	48	M-BOX	P-BOX,M-BOX	
SPARK	2013		DWO4CTE	DWO4CTE		T48			MEG / CR	48	M-BOX	P-BOX,M-BOX	

















CHEVROLET-DAEWOO®

AVEO	2006	2011	DWO4RMH	DWO4RTE	DWO4RFH	T33			MEG / CR	48-A	Y	Y	
KALOS	2002	2006	DWO4RMH	DWO4RTE	DWO4RFH	T33			MEG / CR	48-A	Y	Y	
LACETTI	2002	2004	DWO4RMH	DWO4RTE	DWO4RFH	T33			MEG / CR	48-A	Y	Y	
LANOS	2002	2004	DWO5MH	DWO5TE	DWO5FH	T33			MEG / CR	48-A	Y	Y	
LEGANZA	2000	2008	DWO5MH	DWO5TE	DWO5FH	T33			MEG / CR	48-A	Y	Y	
MATIZ	2001	2005	DWO6BTE	DWO6BTE		T33			MEG / CR	48-A	Y	Y	
MATIZ	2006		DWO4CTE	DWO4CTE		T33			MEG / CR	48-A	Y	Y	
NUBIRA	2002	2006	DWO4CTE	DWO4CTE		T33			MEG / CR	48-A	Y	Y	
NUBIRA	2002	2006	DWO4RMH	DWO4RTE	DWO4RFH	T33			MEG / CR	48-A	Y	Y	



Car Keys Guide / Guida Chiavi Auto / Marktführer für Autoschlüssel / Guide Clés pour Voitures
 Guía Llaves para Coches / Guia Chaves para Carros

New Updates

1	2	2a	3	3a	3b	E3 / E4 / E2			6	42+71	72	43 44a	12
						TRANSPONDER INFO				IGNITION			
													
CAR MAKE MODEL	FROM	TO	SILCA REF.	SILCA REF.	SILCA REF.	TRANSP. COPY	TRANSP. PROGR.	GEN. ON GTI	TRANSP. TYPE	FAST COPY PLUS RW4 PLUS FAST COPY / RW4	FAST COPY PLUS RW4 PLUS	FAST COPY RW4 + P-BOX/M-BOX	STP
													

For more info on the uses of car keys, refer to the Silca Electronic Key Catalogue:



CHEVROLET-DAEWOO®

TACUMA	2000	2008	DWO4RMH	DWO4RTE	DWO4RFH	T33			MEG / CR	48-A	Y	Y	
--------	------	------	---------	---------	---------	-----	--	--	----------	------	---	---	--

CITROËN®

JUMPER	2002	2005	SIP22MH	SIP22TE	SIP22FH	T48			MEG / CR	48	M-BOX	P-BOX,M-BOX	
RELAY	2002	2005	SIP22MH	SIP22TE	SIP22FH	T48			MEG / CR	48	M-BOX	P-BOX,M-BOX	
XANTIA	1999	2001	SX9MH	SX9TE		T48			MEG / CR	48	M-BOX	P-BOX,M-BOX	

FERRARI®

CALIFORNIA	2008	2011	SIP22MH	SIP22TE	SIP22FH	T48			MEG / CR	48	M-BOX	P-BOX,M-BOX	
458	2009	2011	SIP22MH	SIP22TE	SIP22FH	T48			MEG / CR	48	M-BOX	P-BOX,M-BOX	
612 SCAGLIETTI	2004	2011	SIP22MH	SIP22TE	SIP22FH	T48			MEG / CR	48	M-BOX	P-BOX,M-BOX	

FIAT®

ALBEA	2002	2012	SIP22MH	SIP22TE	SIP22FH	T48			MEG / CR	48	M-BOX	P-BOX,M-BOX	
BRAVO	2007	2015	SIP22MH	SIP22TE	SIP22FH	T48			MEG / CR	48	M-BOX	P-BOX,M-BOX	
DOBLÒ	2000	2006	SIP22MH	SIP22TE	SIP22FH	T48			MEG / CR	48	M-BOX	P-BOX,M-BOX	
DOBLÒ (S.AMERICA)	2006		SIP22MH	SIP22TE	SIP22FH	T48			MEG / CR	48	M-BOX	P-BOX,M-BOX	
DUCATO	2002	2005	SIP22MH	SIP22TE	SIP22FH	T48			MEG / CR	48	M-BOX	P-BOX,M-BOX	
IDEA	2003	2009	SIP22MH	SIP22TE	SIP22FH	T48			MEG / CR	48	M-BOX	P-BOX,M-BOX	
IDEA (S.AMERICA)	2009		SIP22MH	SIP22TE	SIP22FH	T48			MEG / CR	48	M-BOX	P-BOX,M-BOX	
LINEA	2007	2015	SIP22MH	SIP22TE	SIP22FH	T48			MEG / CR	48	M-BOX	P-BOX,M-BOX	
MILLE	2005	2013	SIP22MH	SIP22TE	SIP22FH	T48			MEG / CR	48	M-BOX	P-BOX,M-BOX	
MULTIPLA	1998	2015	GT15RMH	GT15RBTE	GT15RFH	T48			MEG / CR	48	M-BOX	P-BOX,M-BOX	
PALIO	2002	2010	GT15RMH	GT15RBTE	GT15RFH	T48			MEG / CR	48	M-BOX	P-BOX,M-BOX	
PUNTO	1999	2005	GT15RMH	GT15RBTE	GT15RFH	T48			MEG / CR	48	M-BOX	P-BOX,M-BOX	
PUNTO	2006	2011	SIP22MH	SIP22TE	SIP22FH	T48			MEG / CR	48	M-BOX	P-BOX,M-BOX	
SEICENTO	2000	2010	GT15RMH	GT15RBTE	GT15RFH	T48			MEG / CR	48	M-BOX	P-BOX,M-BOX	
SIENA	2002	2011	GT15RMH	GT15RBTE	GT15RFH	T48			MEG / CR	48	M-BOX	P-BOX,M-BOX	
STILO	2001	2008	SIP22MH	SIP22TE	SIP22FH	T48			MEG / CR	48	M-BOX	P-BOX,M-BOX	
STILO (S.AMERICA)	2009	2011	SIP22MH	SIP22TE	SIP22FH	T48			MEG / CR	48	M-BOX	P-BOX,M-BOX	

GMC (GM)®

CANYON (CDN)	2008	2012	TOY43RMH	TOY43RATE	TOY43RFH	T48			MEG / CR	48	M-BOX	P-BOX,M-BOX	
--------------	------	------	----------	-----------	----------	-----	--	--	----------	----	-------	-------------	--













GREAT WALL®

HAFU	2006		TOY43RMH	TOY43RATE	TOY43RFH	T48			MEG / CR	48	M-BOX	P-BOX,M-BOX	
HOVER	2006		TOY43RMH	TOY43RATE	TOY43RFH	T48			MEG / CR	48	M-BOX	P-BOX,M-BOX	
STEED	2009	2012	TOY43RMH	TOY43RATE	TOY43RFH	T48			MEG / CR	48	M-BOX	P-BOX,M-BOX	
V SERIES	2006		TOY43RMH	TOY43RATE	TOY43RFH	T48			MEG / CR	48	M-BOX	P-BOX,M-BOX	



Car Keys Guide / Guida Chiavi Auto / Marktführer für Autoschlüssel / Guide Clés pour Voitures
 Guía Llaves para Coches / Guia Chaves para Carros

New Updates

1	2	2a	3	3a	3b	E3 / E4 / E2			6	42+71	72	43 44a	12
						TRANSPONDER INFO				IGNITION			
CAR MAKE MODEL	FROM	TO	SILCA REF.	SILCA REF.	SILCA REF.	TRANSP. COPY	TRANSP. PROGR.	GEN. ON GTI	TRANSP. TYPE	FAST COPY PLUS RW4 PLUS FAST COPY / RW4	FAST COPY PLUS RW4 PLUS	FAST COPY RW4 + P-BOX/M-BOX	STP
													

For more info on the uses of car keys, refer to the Silca Electronic Key Catalogue:



GREAT WALL®

WINGLE	2006		TOY43RMH	TOY43RATE	TOY43RFH	T48			MEG / CR	48	M-BOX	P-BOX,M-BOX	
X SERIES	2006		TOY43RMH	TOY43RATE	TOY43RFH	T48			MEG / CR	48	M-BOX	P-BOX,M-BOX	

HOLDEN®

BARINA	2006		DWO4RMH	DWO4RTE	DWO4RFH	T48			MEG / CR	48	M-BOX	P-BOX,M-BOX	
FRONTERA	1999	2004	HON58RMH	HON58RTE	HON58RFH	T48			MEG / CR	48	M-BOX	P-BOX,M-BOX	

HONDA®

ACCORD	1999	2002	HON58RMH	HON58RTE	HON58RFH	T48			MEG / CR	48	M-BOX	P-BOX,M-BOX	
ACCORD	1999	2002	HON65RTE	HON65RTE		T48			MEG / CR	48	M-BOX	P-BOX,M-BOX	
ACCORD	2003	2006	HON66MH	HON66TE	HON66FH	T48			MEG / CR	48	M-BOX	P-BOX,M-BOX	
CITY	2002	2007	HON66MH	HON66TE	HON66FH	T48			MEG / CR	48	M-BOX	P-BOX,M-BOX	
CIVIC	1999	2002	HON58RMH	HON58RTE	HON58RFH	T48			MEG / CR	48	M-BOX	P-BOX,M-BOX	
CIVIC	2002	2005	HON66MH	HON66TE	HON66FH	T48			MEG / CR	48	M-BOX	P-BOX,M-BOX	
CR-V	1999	2001	HON58RMH	HON58RTE	HON58RFH	T48			MEG / CR	48	M-BOX	P-BOX,M-BOX	
CR-V	2002	2006	HON66MH	HON66TE	HON66FH	T48			MEG / CR	48	M-BOX	P-BOX,M-BOX	
EDIX [J]	2004	2007	HON66MH	HON66TE	HON66FH	T48			MEG / CR	48	M-BOX	P-BOX,M-BOX	
FR-V	2004	2007	HON66MH	HON66TE	HON66FH	T48			MEG / CR	48	M-BOX	P-BOX,M-BOX	
HR-V	1999	2005	HON58RMH	HON58RTE	HON58RFH	T48			MEG / CR	48	M-BOX	P-BOX,M-BOX	
INSIGHT	2001	2005	HON58RMH	HON58RTE	HON58RFH	T48			MEG / CR	48	M-BOX	P-BOX,M-BOX	
JAZZ	2001	2007	HON66MH	HON66TE	HON66FH	T48			MEG / CR	48	M-BOX	P-BOX,M-BOX	
LOGO	1999	2001	HON58RMH	HON58RTE	HON58RFH	T48			MEG / CR	48	M-BOX	P-BOX,M-BOX	
SHUTTLE	2000	2003	HON58RMH	HON58RTE	HON58RFH	T48			MEG / CR	48	M-BOX	P-BOX,M-BOX	
STREAM	2001	2003	HON58RMH	HON58RTE	HON58RFH	T48			MEG / CR	48	M-BOX	P-BOX,M-BOX	
STREAM	2003	2007	HON66MH	HON66TE	HON66FH	T48			MEG / CR	48	M-BOX	P-BOX,M-BOX	
S2000	2000	2003	HON58RMH	HON58RTE	HON58RFH	T48			MEG / CR	48	M-BOX	P-BOX,M-BOX	
S2000	2004	2005	HON66MH	HON66TE	HON66FH	T48			MEG / CR	48	M-BOX	P-BOX,M-BOX	

















ISUZU®

ASCENDER	2003	2012	TOY43RMH	TOY43RATE	TOY43RFH	T48			MEG / CR	48	M-BOX	P-BOX,M-BOX	
AXIOM	2003	2006	HON58RMH	HON58RTE	HON58RFH	T48			MEG / CR	48	M-BOX	P-BOX,M-BOX	
D-MAX	2002	2006	TOY43RMH	TOY43RATE	TOY43RFH	T48			MEG / CR	48	M-BOX	P-BOX,M-BOX	
I-280	2004	2006	TOY43RMH	TOY43RATE	TOY43RFH	T48			MEG / CR	48	M-BOX	P-BOX,M-BOX	
I-290	2007	2012	TOY43RMH	TOY43RATE	TOY43RFH	T48			MEG / CR	48	M-BOX	P-BOX,M-BOX	
I-350	2004	2006	TOY43RMH	TOY43RATE	TOY43RFH	T48			MEG / CR	48	M-BOX	P-BOX,M-BOX	
I-370	2007	2012	TOY43RMH	TOY43RATE	TOY43RFH	T48			MEG / CR	48	M-BOX	P-BOX,M-BOX	
KB240	2007		TOY43RMH	TOY43RATE	TOY43RFH	T48			MEG / CR	48	M-BOX	P-BOX,M-BOX	

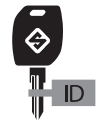

Car Keys Guide / Guida Chiavi Auto / Marktführer für Autoschlüssel / Guide Clés pour Voitures Guía Llaves para Coches / Guia Chaves para Carros

New Updates

1	2	2a	3	3a	3b	E3 / E4 / E2			6	42+71	72	43 44a	12
						TRANSPONDER INFO				IGNITION			
													
CAR MAKE MODEL	FROM	TO	SILCA REF.	SILCA REF.	SILCA REF.	TRANSP. COPY	TRANSP. PROGR.	GEN. ON GTI	TRANSP. TYPE	FAST COPY PLUS RW4 PLUS FAST COPY / RW4	FAST COPY PLUS RW4 PLUS	FAST COPY RW4 + P-BOX/M-BOX	STP
													

For more info on the uses of car keys, refer to the Silca Electronic Key Catalogue:

















ISUZU®													
KB300	2007		TOY43RMH	TOY43RATE	TOY43RFH	T48			MEG / CR	48	M-BOX	P-BOX,M-BOX	
RODEO	1999	2003	HON58RMH	HON58RTE	HON58RFH	T48			MEG / CR	48	M-BOX	P-BOX,M-BOX	
RODEO	2004	2010	TOY43RMH	TOY43RATE	TOY43RFH	T48			MEG / CR	48	M-BOX	P-BOX,M-BOX	
IVECO®													
DAILY	2006		GT10MH	GT10BTE		T48			MEG / CR	48	M-BOX	P-BOX,M-BOX	
KIA®													
CARNIVAL	1999	2000	KIA3RMH	KIA3RTE	KIA3RFH	T33			MEG / CR	48-K	Y	Y	
CLARUS	1998	2001	KIA3RMH	KIA3RTE	KIA3RFH	T33			MEG / CR	48-K	Y	Y	
PRIDE	1999	2001	KIA3RMH	KIA3RTE	KIA3RFH	T33			MEG / CR	48-K	Y	Y	
RETONA	1998	2003	KIA3RMH	KIA3RTE	KIA3RFH	T33			MEG / CR	48	Y	Y	
RETONA	1998	2003	KIA3RMH	KIA3RTE	KIA3RFH	T48			MEG / CR	48	M-BOX	P-BOX,M-BOX	
SEDONA	1999	2000	KIA3RMH	KIA3RTE	KIA3RFH	T33			MEG / CR	48-K	Y	Y	
SEPHIA	1997	2003	KIA3RMH	KIA3RTE	KIA3RFH	T33			MEG / CR	48	Y	Y	
SEPHIA	1997	2003	KIA3RMH	KIA3RTE	KIA3RFH	T48			MEG / CR	48	M-BOX	P-BOX,M-BOX	
SHUMA	1998	2001	KIA3RMH	KIA3RTE	KIA3RFH	T33			MEG / CR	48-K	Y	Y	
SPORTAGE	1999	2001	KIA3RMH	KIA3RTE	KIA3RFH	T33			MEG / CR	48-K	Y	Y	
LAMBORGHINI®													
GALLARDO	2003	2013	HU66MH	HU66TE	HU66FH	T48			MEG / CR	48	M-BOX	P-BOX,M-BOX	
MURCIELAGO		2010	HU66MH	HU66TE	HU66FH	T48			MEG / CR	48	M-BOX	P-BOX,M-BOX	
LANCIA®													
DELTA	2008	2014	SIP22MH	SIP22TE	SIP22FH	T48			MEG / CR	48	M-BOX	P-BOX,M-BOX	
LYBRA	1999	2006	SIP22MH	SIP22TE	SIP22FH	T48			MEG / CR	48	M-BOX	P-BOX,M-BOX	
MUSA	2004	2009	SIP22MH	SIP22TE	SIP22FH	T48			MEG / CR	48	M-BOX	P-BOX,M-BOX	
THESIS	2002	2009	SIP22MH	SIP22TE	SIP22FH	T48			MEG / CR	48	M-BOX	P-BOX,M-BOX	
YPSILON	2003	2011	SIP22MH	SIP22TE	SIP22FH	T48			MEG / CR	48	M-BOX	P-BOX,M-BOX	
MASERATI®													
GRAN SPORT	2004	2007	SIP22MH	SIP22TE	SIP22FH	T48			MEG / CR	48	M-BOX	P-BOX,M-BOX	
GRAN TURISMO	2007	2012	SIP22MH	SIP22TE	SIP22FH	T48			MEG / CR	48	M-BOX	P-BOX,M-BOX	
QUATTROPORTE	2004	2011	SIP22MH	SIP22TE	SIP22FH	T48			MEG / CR	48	M-BOX	P-BOX,M-BOX	
OPEL-VAUXALL®													
FRONTERA	1999	2003	HON58RMH	HON58RTE	HON58RFH	T48			MEG / CR	48	M-BOX	P-BOX,M-BOX	
PEUGEOT®													
BOXER	2002	2005	SIP22MH	SIP22TE	SIP22FH	T48			MEG / CR	48	M-BOX	P-BOX,M-BOX	
607	2001	2004	NE78MH	NE78TE		T48			MEG / CR	48	M-BOX	P-BOX,M-BOX	



Car Keys Guide / Guida Chiavi Auto / Marktführer für Autoschlüssel / Guide Clés pour Voitures Guía Llaves para Coches / Guia Chaves para Carros













New Updates

1	2	2a	3	3a	3b	E3 / E4 / E2			6	42+71	72	43 44a	12
						TRANSPONDER INFO				IGNITION			
CAR MAKE MODEL	FROM	TO	SILCA REF.	SILCA REF.	SILCA REF.	TRANSP. COPY	TRANSP. PROGR.	GEN. ON GTI	TRANSP. TYPE	FAST COPY PLUS RW4 PLUS FAST COPY / RW4	FAST COPY PLUS RW4 PLUS	FAST COPY RW4 + P-BOX/M-BOX	STP
													
For more info on the uses of car keys, refer to the Silca Electronic Key Catalogue: 													
PONTIAC®													
G3	2010		DWO4RMH	DWO4RTE	DWO4RFH	T33			MEG / CR	48-A	Y	Y	
WAVE	2004	2006	DWO4RMH	DWO4RTE	DWO4RFH	T48			MEG / CR	48	M-BOX	P-BOX,M-BOX	
PORSCHE®													
BOXSTER	1999	2004	HU66MH	HU66TE	HU66FH	T48			MEG / CR	48	M-BOX	P-BOX,M-BOX	
911	1999	2004	HU66MH	HU66TE	HU66FH	T48			MEG / CR	48	M-BOX	P-BOX,M-BOX	
PROTON®													
GEN-2	2004	2012	PO1RMH	PO1RTE	PO1RFH	T48			MEG / CR	48	M-BOX	P-BOX,M-BOX	
JUMBUCK	2002	2010	PO1RMH	PO1RTE	PO1RFH	T48			MEG / CR	48	M-BOX	P-BOX,M-BOX	
PERSONA	2007		PO1RMH	PO1RTE	PO1RFH	T48			MEG / CR	48	M-BOX	P-BOX,M-BOX	
SAGA	2008	2010	PO1RMH	PO1RTE	PO1RFH	T48			MEG / CR	48	M-BOX	P-BOX,M-BOX	
SAVVY	2005	2011	PO1RMH	PO1RTE	PO1RFH	T48			MEG / CR	48	M-BOX	P-BOX,M-BOX	
WIRA	2002	2009	PO1RMH	PO1RTE	PO1RFH	T48			MEG / CR	48	M-BOX	P-BOX,M-BOX	
SEAT®													
ALHAMBRA	2006	2010	HU66MH	HU66TE	HU66FH	T48			MEG / CR	48	M-BOX	P-BOX,M-BOX	
ALHAMBRA	2010	2015	HU66MH	HU66TE	HU66FH	T48			MEG / CR	48-A3	M-BOX	P-BOX,M-BOX	
ALTEA	2004	2005	HU66MH	HU66TE	HU66FH	T48			MEG / CR	48	M-BOX	P-BOX,M-BOX	
ALTEA	2004	2015	HU66MH	HU66TE	HU66FH	T48			MEG / CR	48-A3	M-BOX	P-BOX,M-BOX	
ALTEA XL	2006	2015	HU66MH	HU66TE	HU66FH	T48			MEG / CR	48-A3	M-BOX	P-BOX,M-BOX	
CORDOBA	2002	2009	HU66MH	HU66TE	HU66FH	T48			MEG / CR	48	M-BOX	P-BOX,M-BOX	
EXEO	2008	2013	HU66MH	HU66TE	HU66FH	T48			MEG / CR	48-A3	M-BOX	P-BOX,M-BOX	
FREETRACK	2008	2015	HU66MH	HU66TE	HU66FH	T48			MEG / CR	48-A3	M-BOX	P-BOX,M-BOX	
IBIZA	2002	2009	HU66MH	HU66TE	HU66FH	T48			MEG / CR	48	M-BOX	P-BOX,M-BOX	
IBIZA	2008		HU66MH	HU66TE	HU66FH	T48			MEG / CR	48-A3	M-BOX	P-BOX,M-BOX	
LEON	1999	2005	HU66MH	HU66TE	HU66FH	T48			MEG / CR	48	M-BOX	P-BOX,M-BOX	
LEON	2005	2012	HU66MH	HU66TE	HU66FH	T48			MEG / CR	48-A3	M-BOX	P-BOX,M-BOX	
MII	2012		HU66MH	HU66TE	HU66FH	T48			MEG / CR	48-A3	M-BOX	P-BOX,M-BOX	
TOLEDO	1999	2004	HU66MH	HU66TE	HU66FH	T48			MEG / CR	48	M-BOX	P-BOX,M-BOX	
TOLEDO	2004	2009	HU66MH	HU66TE	HU66FH	T48			MEG / CR	48-A3	M-BOX	P-BOX,M-BOX	
ŠKODA®													
CITIGO	2012		HU66MH	HU66TE	HU66FH	T48			MEG / CR	48-A4	M-BOX	P-BOX,M-BOX	
FABIA	1999	2007	HU66MH	HU66TE	HU66FH	T48			MEG / CR	48	M-BOX	P-BOX,M-BOX	
FABIA	2007	2014	HU66MH	HU66TE	HU66FH	T48			MEG / CR	48-A4	M-BOX	P-BOX,M-BOX	
FELICIA	1999	2001	HU66MH	HU66TE	HU66FH	T48			MEG / CR	48	M-BOX	P-BOX,M-BOX	
LAURA	2007	2012	HU66MH	HU66TE	HU66FH	T48			MEG / CR	48-A4	M-BOX	P-BOX,M-BOX	



Car Keys Guide / Guida Chiavi Auto / Marktführer für Autoschlüssel / Guide Clés pour Voitures
 Guía Llaves para Coches / Guia Chaves para Carros

New Updates

1	2	2a	3	3a	3b	E3 / E4 / E2			6	42+71	72	43 44a	12
						TRANSPONDER INFO				IGNITION			
CAR MAKE MODEL	FROM	TO	SILCA REF.	SILCA REF.	SILCA REF.	TRANSP. COPY	TRANSP. PROGR.	GEN. ON GTI	TRANSP. TYPE	FAST COPY PLUS RW4 PLUS FAST COPY / RW4	FAST COPY PLUS RW4 PLUS	FAST COPY RW4 + P-BOX/M-BOX	STP
													

For more info on the uses of car keys, refer to the Silca Electronic Key Catalogue:



ŠKODA®

OCTAVIA	1998	2007	HU66MH	HU66TE	HU66FH	T48			MEG / CR	48	M-BOX	P-BOX,M-BOX	
OCTAVIA	2004	2012	HU66MH	HU66TE	HU66FH	T48			MEG / CR	48-A4	M-BOX	P-BOX,M-BOX	
PRAKTIK	2007	2015	HU66MH	HU66TE	HU66FH	T48			MEG / CR	48-A4	M-BOX	P-BOX,M-BOX	
ROOMSTER	2006	2015	HU66MH	HU66TE	HU66FH	T48			MEG / CR	48-A4	M-BOX	P-BOX,M-BOX	
ROOMSTER SCOUT	2007	2015	HU66MH	HU66TE	HU66FH	T48			MEG / CR	48-A4	M-BOX	P-BOX,M-BOX	
SUPERB	2001	2008	HU66MH	HU66TE	HU66FH	T48			MEG / CR	48	M-BOX	P-BOX,M-BOX	
SUPERB	2008	2015	HU66MH	HU66TE	HU66FH	T48			MEG / CR	48-A4	M-BOX	P-BOX,M-BOX	
YETI	2009	2013	HU66MH	HU66TE	HU66FH	T48			MEG / CR	48-A4	M-BOX	P-BOX,M-BOX	

SSANGYONG®

ACTYON	2008	2012	SSY3MH	SSY3TE	SSY3FH	T48			MEG / CR	48	M-BOX	P-BOX,M-BOX	
MUSSO	2001	2005	SSY4RTE	SSY4RTE		T48			MEG / CR	48	M-BOX	P-BOX,M-BOX	
REXTON	2001	2005	SSY4RTE	SSY4RTE		T48			MEG / CR	48	M-BOX	P-BOX,M-BOX	
REXTON	2008	2012	SSY3MH	SSY3TE	SSY3FH	T48			MEG / CR	48	M-BOX	P-BOX,M-BOX	

TAGAZ®

ROAD PARTNER	2001	2005	SSY4RTE	SSY4RTE		T48			MEG / CR	48	M-BOX	P-BOX,M-BOX	
--------------	------	------	---------	---------	--	-----	--	--	----------	----	-------	-------------	--













VOLKSWAGEN®

AMAROK	2011		HU66MH	HU66TE	HU66FH	T48			MEG / CR	48-A1	M-BOX	P-BOX,M-BOX	
BEETLE	1999	2011	HU66MH	HU66TE	HU66FH	T48			MEG / CR	48	M-BOX	P-BOX,M-BOX	
BEETLE	2003	2013	HU66MH	HU66TE	HU66FH	T48			MEG / CR	48-A1	M-BOX	P-BOX,M-BOX	
BORA	1998	2005	HU66MH	HU66TE	HU66FH	T48			MEG / CR	48	M-BOX	P-BOX,M-BOX	
CADDY	2004		HU66MH	HU66TE	HU66FH	T48			MEG / CR	48-A1	M-BOX	P-BOX,M-BOX	
CARAVELLE	2003	2009	HU66MH	HU66TE	HU66FH	T48			MEG / CR	48-A1	M-BOX	P-BOX,M-BOX	
CRAFTER	2006		HU116TE	HU116TE		T48			MEG / CR	48-A1	M-BOX	P-BOX,M-BOX	
CROSS GOLF	2006	2012	HU66MH	HU66TE	HU66FH	T48			MEG / CR	48-A1	M-BOX	P-BOX,M-BOX	
EOS	2006	2015	HU66MH	HU66TE	HU66FH	T48			MEG / CR	48-A1	M-BOX	P-BOX,M-BOX	
EURO VAN	2000	2004	HU66MH	HU66TE	HU66FH	T48			MEG / CR	48	M-BOX	P-BOX,M-BOX	
FOX	2005	2012	HU66MH	HU66TE	HU66FH	T48			MEG / CR	48	M-BOX	P-BOX,M-BOX	
GOLF	1998	2004	HU66MH	HU66TE	HU66FH	T48			MEG / CR	48	M-BOX	P-BOX,M-BOX	
GOLF	2004	2012	HU66MH	HU66TE	HU66FH	T48			MEG / CR	48-A1	M-BOX	P-BOX,M-BOX	
GOLF CABRIO	2004	2012	HU66MH	HU66TE	HU66FH	T48			MEG / CR	48-A1	M-BOX	P-BOX,M-BOX	
GOLF GTI	2000	2004	HU66MH	HU66TE	HU66FH	T48			MEG / CR	48	M-BOX	P-BOX,M-BOX	
INDIVIDUAL	2004	2008	HU66MH	HU66TE	HU66FH	T48			MEG / CR	48-A1	M-BOX	P-BOX,M-BOX	
JETTA	2000	2004	HU66MH	HU66TE	HU66FH	T48			MEG / CR	48	M-BOX	P-BOX,M-BOX	
JETTA	2004	2012	HU66MH	HU66TE	HU66FH	T48			MEG / CR	48-A1	M-BOX	P-BOX,M-BOX	



Car Keys Guide / Guida Chiavi Auto / Marktführer für Autoschlüssel / Guide Clés pour Voitures Guía Llaves para Coches / Guia Chaves para Carros

New Updates

1	2	2a	3	3a	3b	E3 / E4 / E2			6	42+71	72	43 44a	12
						TRANSPONDER INFO				IGNITION			
CAR MAKE MODEL	FROM	TO	SILCA REF.	SILCA REF.	SILCA REF.	TRANSP. COPY	TRANSP. PROGR.	GEN. ON GTI	TRANSP. TYPE	FAST COPY PLUS RW4 PLUS FAST COPY / RW4	FAST COPY PLUS RW4 PLUS	FAST COPY RW4 + P-BOX/M-BOX	STP
													

For more info on the uses of car keys, refer to the Silca Electronic Key Catalogue:

VOLKSWAGEN®

KOMBI	2003	2009	HU66MH	HU66TE	HU66FH	T48			MEG / CR	48-A1	M-BOX	P-BOX,M-BOX	
LAVIDA	2008		HU66MH	HU66TE	HU66FH	T48			MEG / CR	48	M-BOX	P-BOX,M-BOX	
MULTIVAN	2003	2009	HU66MH	HU66TE	HU66FH	T48			MEG / CR	48-A1	M-BOX	P-BOX,M-BOX	
PASSAT	1998	2004	HU66MH	HU66TE	HU66FH	T48			MEG / CR	48	M-BOX	P-BOX,M-BOX	
PASSAT	2004	2005	HU66MH	HU66TE	HU66FH	T48			MEG / CR	48-A1	M-BOX	P-BOX,M-BOX	
PASSAT W8	2002	2004	HU66MH	HU66TE	HU66FH	T48			MEG / CR	48	M-BOX	P-BOX,M-BOX	
POLO	2001	2005	HU66MH	HU66TE	HU66FH	T48			MEG / CR	48	M-BOX	P-BOX,M-BOX	
POLO	2005	2014	HU66MH	HU66TE	HU66FH	T48			MEG / CR	48-A1	M-BOX	P-BOX,M-BOX	
RABBIT	2003	2008	HU66MH	HU66TE	HU66FH	T48			MEG / CR	48-A1	M-BOX	P-BOX,M-BOX	
SAGITAR	2011		HU66MH	HU66TE	HU66FH	T48			MEG / CR	48	M-BOX	P-BOX,M-BOX	
SCIROCCO	2008	2014	HU66MH	HU66TE	HU66FH	T48			MEG / CR	48-A1	M-BOX	P-BOX,M-BOX	
SHARAN	2005	2009	HU66MH	HU66TE	HU66FH	T48			MEG / CR	48	M-BOX	P-BOX,M-BOX	
SHARAN	2010	2015	HU66MH	HU66TE	HU66FH	T48			MEG / CR	48-A1	M-BOX	P-BOX,M-BOX	
TIGUAN	2007	2015	HU66MH	HU66TE	HU66FH	T48			MEG / CR	48-A1	M-BOX	P-BOX,M-BOX	
TOURAN	2003	2012	HU66MH	HU66TE	HU66FH	T48			MEG / CR	48-A1	M-BOX	P-BOX,M-BOX	
TRANSPORTER	2004	2014	HU66MH	HU66TE	HU66FH	T48			MEG / CR	48-A1	M-BOX	P-BOX,M-BOX	
UP!	2012		HU66MH	HU66TE	HU66FH	T48			MEG / CR	48-A1	M-BOX	P-BOX,M-BOX	
VENTO	2010		HU66MH	HU66TE	HU66FH	T48			MEG / CR	48	M-BOX	P-BOX,M-BOX	

VOLKSWAGEN S.AMERICA®

BEETLE	2008		HU66MH	HU66TE	HU66FH	T48			MEG / CR	48-A1	M-BOX	P-BOX,M-BOX	
BORA	2008	2012	HU66MH	HU66TE	HU66FH	T48			MEG / CR	48-A1	M-BOX	P-BOX,M-BOX	
CROSSFOX	2010		HU66MH	HU66TE	HU66FH	T48			MEG / CR	48-A1	M-BOX	P-BOX,M-BOX	
FOX	2009		HU66MH	HU66TE	HU66FH	T48			MEG / CR	48-A1	M-BOX	P-BOX,M-BOX	
GOL	1999	2004	HU49RTE	HU49RTE		T48			MEG / CR	48	M-BOX	P-BOX,M-BOX	
GOL	1999	2004	HU70TE	HU70TE		T48			MEG / CR	48	M-BOX	P-BOX,M-BOX	
GOL	2005	2008	HU66MH	HU66TE	HU66FH	T48			MEG / CR	48	M-BOX	P-BOX,M-BOX	
GOL	2009		HU66MH	HU66TE	HU66FH	T48			MEG / CR	48-A1	M-BOX	P-BOX,M-BOX	
GOLF	1998	2004	HU66MH	HU66TE	HU66FH	T48			MEG / CR	48	M-BOX	P-BOX,M-BOX	
KOMBI	1999	2004	HU49RTE	HU49RTE		T48			MEG / CR	48	M-BOX	P-BOX,M-BOX	
KOMBI	1999	2004	HU70TE	HU70TE		T48			MEG / CR	48	M-BOX	P-BOX,M-BOX	
PARATI	1999	2004	HU49RTE	HU49RTE		T48			MEG / CR	48	M-BOX	P-BOX,M-BOX	
PARATI	1999	2004	HU70TE	HU70TE		T48			MEG / CR	48	M-BOX	P-BOX,M-BOX	
PARATI	2005	2008	HU66MH	HU66TE	HU66FH	T48			MEG / CR	48	M-BOX	P-BOX,M-BOX	
PARATI	2009		HU66MH	HU66TE	HU66FH	T48			MEG / CR	48-A1	M-BOX	P-BOX,M-BOX	

**Car Keys Guide / Guida Chiavi Auto / Marktführer für Autoschlüssel / Guide Clés pour Voitures
Guía Llaves para Coches / Guia Chaves para Carros**

New Updates

1	2	2a	3	3a	3b	E3 / E4 / E2			6	42+71	72	43 44a	12
						TRANSPONDER INFO				IGNITION			
CAR MAKE MODEL	FROM	TO	SILCA REF.	SILCA REF.	SILCA REF.	TRANSP. COPY	TRANSP. PROGR.	GEN. ON GTI	TRANSP. TYPE	FAST COPY PLUS RW4 PLUS FAST COPY / RW4	FAST COPY PLUS RW4 PLUS	FAST COPY RW4 + P-BOX/M-BOX	STP

For more info on the uses of car keys, refer to the Silca Electronic Key Catalogue:



VOLKSWAGEN S.AMERICA®													
SANTANA 2000	1998	2006	WT9TE	WT9TE		T48			MEG / CR	48	M-BOX	P-BOX,M-BOX	
SAVEIRO	1999	2006	HU70TE	HU70TE		T48			MEG / CR	48	M-BOX	P-BOX,M-BOX	
SAVEIRO	1999	2006	HU49RTE	HU49RTE		T48			MEG / CR	48	M-BOX	P-BOX,M-BOX	
SAVEIRO	2009		HU66MH	HU66TE	HU66FH	T48			MEG / CR	48-A1	M-BOX	P-BOX,M-BOX	
SPACEFOX	2006	2010	HU66MH	HU66TE	HU66FH	T48			MEG / CR	48	M-BOX	P-BOX,M-BOX	
SPORTVAN	2006	2010	HON66MH	HON66TE	HON66FH	T48			MEG / CR	48	M-BOX	P-BOX,M-BOX	
SURAN	2006	2010	HU66MH	HU66TE	HU66FH	T48			MEG / CR	48	M-BOX	P-BOX,M-BOX	
VOYAGE	2009		HU66MH	HU66TE	HU66FH	T48			MEG / CR	48-A1	M-BOX	P-BOX,M-BOX	

VOLVO®													
S60	2000	2009	NE66TE	NE66TE		T48			MEG / CR	48	M-BOX	P-BOX,M-BOX	
S80	1998	2006	NE66TE	NE66TE		T48			MEG / CR	48	M-BOX	P-BOX,M-BOX	
V70	2000	2007	NE66TE	NE66TE		T48			MEG / CR	48	M-BOX	P-BOX,M-BOX	
XC70	2001	2007	NE66TE	NE66TE		T48			MEG / CR	48	M-BOX	P-BOX,M-BOX	
XC90	2003	2014	NE66TE	NE66TE		T48			MEG / CR	48	M-BOX	P-BOX,M-BOX	

**Truck Keys Guide / Guida Chiavi Camion / Marktführer für LKW Schlüssel
Guide Clés pour Camions / Guía Llaves para Camiones / Guia Chaves para Camiões**

New Updates

1	2	2a	3	3a	3b	E3 / E4 / E2			6	42+71	72	43 44a	12
						TRANSPONDER INFO				IGNITION			
CAR MAKE MODEL	FROM	TO	SILCA REF.	SILCA REF.	SILCA REF.	TRANSP. COPY	TRANSP. PROGR.	GEN. ON GTI	TRANSP. TYPE	FAST COPY PLUS RW4 PLUS FAST COPY / RW4	FAST COPY PLUS RW4 PLUS	FAST COPY RW4 + P-BOX/M-BOX	STP

For more info on the uses of car keys, refer to the Silca Electronic Key Catalogue:



DAF®													
CF	2002		NE73MH	NE73TE	NE73FH	T48			MEG / CR	48	M-BOX	P-BOX,M-BOX	
LF	2002		NE73MH	NE73TE	NE73FH	T48			MEG / CR	48	M-BOX	P-BOX,M-BOX	
XF	2002		NE73MH	NE73TE	NE73FH	T48			MEG / CR	48	M-BOX	P-BOX,M-BOX	

Flash 008

Four-sided rotating clamps

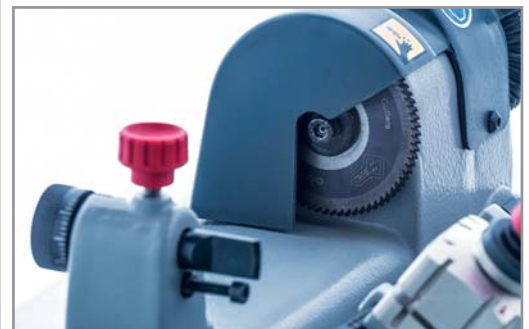

AITiN coated cutter

🇬🇧 Flash 008

Flash 008 is the mechanical key cutting machine for flat cylinder and vehicle keys. It cuts also cruciform keys and keys with long necks, tip stop and flip mechanism.

- Smooth carriage movements.
- Four-sided clamps.
- Resistant-to-wear components.
- Optimized calibration.
- Space-saving solution for fixed or mobile use.

🇮🇹 Flash 008

Flash 008 è la duplicatrice meccanica per chiavi piatte per cilindri e veicoli e per chiavi a croce. La macchina consente di cifrare anche chiavi a collo lungo, con fermo in punta e con meccanismo flip.

- Movimenti del carrello fluidi.
- Morsetti a quattro lati.
- Componenti resistenti all'usura.
- Taratura ottimizzata.
- Soluzione compatta per un utilizzo fisso o mobile.

🇩🇪 Flash 008

Flash 008 ist die mechanische Schlüsselkopiermaschine für flache Zylinder- und Fahrzeugschlüssel, Kreuzbartschlüssel und Schlüssel mit langem Hals, Kopfschlag und Klappschlüssel.

- Mühelose Bewegungen des Frässlittens.
- Vierseitige Spannbacken.
- Verschleißfeste Komponenten.
- Optimierte Kalibrierung.
- Kompakte Lösung für festen oder mobilen Einsatz.

🇫🇷 Flash 008

Flash 008 est la machine mécanique pour tailler les clés plates pour cylindres et véhicules, les clés cruciformes, les clés à tige longue, avec arrêt en pointe et mécanisme flip.

- Mouvements du chariot fluides.
- Étaux 4 faces.
- Composants résistants à l'usure.
- Étalonnage optimisé.
- Une solution compacte pour un usage fixe ou mobile.

🇪🇸 Flash 008

Flash 008 es la duplicadora mecánica para llaves planas para cilindros y vehículos y para llaves en cruz. La máquina corta también llaves con cuello largo, tope en punta y mecanismo flip.

- Movimientos fluidos del carro.
- Mordazas de cuatro lados.
- Componentes resistentes al desgaste.
- Calibración optimizada.
- Solución compacta para un uso fijo o móvil.

🇵🇹 Flash 008

Flash 008 é a máquina duplicadora mecânica para chaves planas para cilindros e veículos, para chaves tetra, e para chaves de colo comprido, com encosto na ponta e com mecanismo flip.

- Movimentos fluidos do carro.
- Mordentes de 4 lados.
- Componentes resistentes ao desgaste.
- Ajuste otimizado.
- Solução compacta para uma utilização fixa ou móvel.

> More info on all Silca websites



ADC219 Cable - Code D747038AD VAG® Instrument Cluster Reset Cable For all keys lost situation - on selected VAG® vehicles

May 2016



 **ADC219 cable is developed specifically for use on selected VAG® vehicles when all vehicle keys have been lost.**

The cable has been designed for advanced auto locksmiths who have a good working technical knowledge of removing, disassembling and re-fitting instrument clusters from vehicles. The cable is used to probe a specific pin located on the PCB board on the reverse side of the instrument cluster in order to put the vehicle into service mode, before a working key can be generated.

 **Il cavo ADC219 è stato sviluppato per far fronte ai casi di perdita totale delle chiavi veicolo su alcuni modelli del gruppo VAG®.**

Il cavo è stato progettato per gli specialisti esperti delle chiavi auto, in grado di smontare, rimuovere e re-installare il quadro strumenti di un veicolo. Il cavo permette di collegarsi direttamente alla scheda elettronica del quadro strumenti (PCB) sul retro che abilita la modalità di servizio del veicolo prima di poter generare una nuova chiave.

 **Das Kabel ADC219 wurde entwickelt für den Fall eines kompletten Schlüsselverlustes für einige Fahrzeugmodelle der VAG®-Gruppe.**

Das Kabel ist für Kfz-Schlüsselprofis konzipiert, die imstande sind das Kombi-Instrument eines Fahrzeugs auszubauen, zu entfernen und wieder einzubauen. Mit diesem Kabel können Sie sich direkt an die Platine des Kombi-Instruments (PCB) verbinden, es auf Service-Modus stellen und dann den neuen Schlüssel reproduzieren.

 **El cable ADC219 se ha desarrollado para resolver los casos de pérdida total de las llaves de vehículos en algunos modelos del grupo VAG®.**

El cable se ha diseñado para los expertos especialistas de las llaves de vehículos, capacitados técnicamente para desmontar, extraer y reinstalar el cuadro de instrumentos de un vehículo. El cable permite conectarse directamente a la placa electrónica del cuadro de instrumentos (PCB), habilitando el modo servicio para poder programar llaves en el vehículo.

 **Le câble ADC219 a été développé pour faire face en cas de perte totale des clés véhicule sur certains modèles du groupe VAG®.**

Le câble a été projeté pour les professionnels experts en clés auto, capables de démonter, enlever et réinstaller le tableau de bord d'un véhicule. Le câble permet de se connecter directement à la carte électronique à l'arrière du tableau de bord (PCB) activant la modalité de service du véhicule avant de pouvoir générer une nouvelle clé.

 **O cabo ADC219 foi desenvolvido para encarar os casos de perda total das chaves em alguns modelos do grupo VAG®.**

O cabo foi projectado para os especialistas experientes de chaves de carro, em grau de desmontar, remover e remontar o quadro de instrumentos de um veículo. O cabo permite ligar-se directamente ao cartão electrónico do quadro de instrumentos (PCB) na parte traseira que habilita a modalidade de serviço do veículo antes de poder gerar uma nova chave.

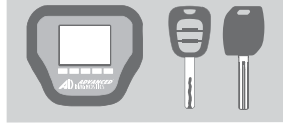

ADS230 Software - Code D747039AD VAG® Instrument Cluster Reset Software For all keys lost situation - on selected VAG® vehicles

May 2016



UK ADS230 VAG® software is designed specifically to be used with the ADC219 cable and Smart Dongle to put the instrument cluster into service mode on selected VAG® vehicles. Once the cluster is in service mode, keys can then be programmed using ADS219 or ADS250 (South America).

IT Il software VAG® ADS230 è stato progettato per essere utilizzato con il cavo ADC219 e Smart Dongle per mettere il cruscotto del veicolo in modalità di servizio su alcuni veicoli del gruppo VAG®. Una volta che il veicolo è in modalità di servizio, le chiavi possono essere programmate, utilizzando i software ADS219 o ADS250 (Sud America).

DE Die Software VAG® ADS230 wurde für die Verwendung mit Kabel ADC219 und Smart Dongle konzipiert, um das Kombi-Instrument auf Service-Modus bei einigen Fahrzeugmodellen der VAG®-Gruppe zu stellen. Sobald das Fahrzeug im Service-Modus ist, können die Schlüssel mit Hilfe der Software ADS219 oder ADS250 (Südamerika) programmiert werden.

FR Le logiciel VAG® ADS230 a été projeté pour être utilisé avec le câble ADC219 et Smart Dongle pour mettre le tableau de bord du véhicule en mode service sur certains véhicules du groupe VAG®. Une fois que le véhicule est en mode service, les clés peuvent être programmées avec les logiciels ADS219 ou ADS250 (Amérique du Sud).

ES El software VAG® ADS230 se ha diseñado específicamente para trabajar con el cable ADC219 y con el Smart Dongle. Su función es la de poner el cuadro de vehículo en modo servicio en ciertos modelos del grupo VAG®. Una vez que el cuadro está en modo servicio se pueden programar las llaves usando el software ADS219 o ADS250 (Sudamérica).

PT O software VAG® ADS230 foi projectado para ser utilizado com o cabo ADC219 e Smart Dongle para pôr o quadro de comandos do veículo em modalidade de serviço em alguns veículos do grupo VAG®. Uma vez que o veículo se encontra em modalidade de serviço, as chaves podem ser programadas, utilizando os software ADS219 o ADS250 (América do Sul).

OFFER DETAILS

Cable	ADC250 or ADC251 + ADC219
Dongle	Smart Dongle
Software category	C
Other software required	ADS219 or ADS250 (South America)
Smart card	Smart Dongle

© All the brands and product names mentioned in this flyer are registered trademarks exclusive property of authorized manufacturers. Said trademarks or trade names are nominated only for the purposes of information in order to be rapidly identified.

www.silca.biz - www.silca-automotive.com - www.advanced-diagnostics.com

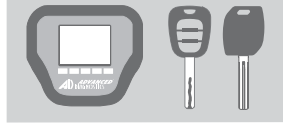

Škoda® Applications

TABLE

			
Škoda® Fabia II Facelift (54) 2010 to 2013	ADC250 or ADC251 + ADC219	Smart Dongle	⊗
Škoda® Octavia II (1Z) 2006 to 2009	ADC250 or ADC251 + ADC219	Smart Dongle	⊗
Škoda® Octavia II (1Z) 2009 to 2013	ADC250 or ADC251 + ADC219	Smart Dongle	⊗
Škoda® Rapid (NH) 2012 to 2013	ADC250 or ADC251 + ADC219	Smart Dongle	⊗
Škoda® Superb II (3T) 2008 to 2013	ADC250 or ADC251 + ADC219	Smart Dongle	⊗
Škoda® Yeti (5L) 2010 to 2013	ADC250 or ADC251 + ADC219	Smart Dongle	⊗

Seat® Applications

TABLE

			
Seat® Alhambra (7N) 2010 to 2013	ADC250 or ADC251 + ADC219	Smart Dongle	⊗
Seat® Cordoba (6L) 2005 to 2009	ADC250 or ADC251 + ADC219	Smart Dongle	⊗
Seat® Ibiza (6J) 2009 to 2013	ADC250 or ADC251 + ADC219	Smart Dongle	⊗
Seat® Ibiza (6J) 2014 onwards	ADC250 or ADC251 + ADC219	Smart Dongle	⊗
Seat® Leon (1P) 2005 to 2009	ADC250 or ADC251 + ADC219	Smart Dongle	⊗
Seat® Leon (1P) 2010 to 2013	ADC250 or ADC251 + ADC219	Smart Dongle	⊗
Seat® Toledo (5P) 2005 to 2009	ADC250 or ADC251 + ADC219	Smart Dongle	⊗
Seat® Toledo (5P) 2010 to 2013	ADC250 or ADC251 + ADC219	Smart Dongle	⊗

© All the brands and product names mentioned in this flyer are registered trademarks exclusive property of authorized manufacturers. Said trademarks or trade names are nominated only for the purposes of information in order to be rapidly identified.

www.silca.biz - www.silca-automotive.com - www.advanced-diagnostics.com

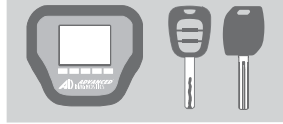

Volkswagen® Applications

TABLE

			
Volkswagen® Amarok (2H) 2010 to 2013	ADC250 or ADC251 + ADC219	Smart Dongle	⊗
Volkswagen® Caddy (2K) 2003 to 2009	ADC250 or ADC251 + ADC219	Smart Dongle	⊗
Volkswagen® Caddy (2C) 2010 to 2013	ADC250 or ADC251 + ADC219	Smart Dongle	⊗
Volkswagen® Eos (1F) 2005 to 2009	ADC250 or ADC251 + ADC219	Smart Dongle	⊗
Volkswagen® Eos (1F) 2009 to 2013	ADC250 or ADC251 + ADC219	Smart Dongle	⊗
Volkswagen® Golf 5 / Jetta / Bora (1K) 2006 to 2009	ADC250 or ADC251 + ADC219	Smart Dongle	⊗
Volkswagen® Golf 6 / Jetta / Bora (5K) 2009 to 2012	ADC250 or ADC251 + ADC219	Smart Dongle	⊗
Volkswagen® Passat USA (NM) 2010 to 2013	ADC250 or ADC251 + ADC219	Smart Dongle	⊗
Volkswagen® Polo (6R) 2009 to 2012	ADC250 or ADC251 + ADC219	Smart Dongle	⊗
Volkswagen® Scirocco (16) 2008 to 2009	ADC250 or ADC251 + ADC219	Smart Dongle	⊗
Volkswagen® Scirocco (16) 2010 to 2013	ADC250 or ADC251 + ADC219	Smart Dongle	⊗
Volkswagen® Sharan (7N) 2010 onwards	ADC250 or ADC251 + ADC219	Smart Dongle	⊗
Volkswagen® Tiguan (5N) 2007 to 2009	ADC250 or ADC251 + ADC219	Smart Dongle	⊗
Volkswagen Tiguan (5N) 2010 onwards	ADC250 or ADC251 + ADC219	Smart Dongle	⊗
Volkswagen® Touran (1T1 and 1T2) 2006 to 2010	ADC250 or ADC251 + ADC219	Smart Dongle	⊗
Volkswagen® Touran II (1T3) 2011 to 2013	ADC250 or ADC251 + ADC219	Smart Dongle	⊗
Volkswagen® Transporter T6 (7E) 2010 to 2013	ADC250 or ADC251 + ADC219	Smart Dongle	⊗

© All the brands and product names mentioned in this flyer are registered trademarks exclusive property of authorized manufacturers. Said trademarks or trade names are nominated only for the purposes of information in order to be rapidly identified.

www.silca.biz - www.silca-automotive.com - www.advanced-diagnostics.com

SILCA FUTURA PROGRAM

Data Update with new systems

Software Vers. 2.17.0 - db 3.02
App Vers. 1.21





Futura

Data update with new systems / Aggiornamento dati con nuovi sistemi / Datenaktualisierung mit neuen Systemen / Mise à jour des données avec nouveaux systèmes / Actualización de datos con sistemas nuevos / Atualização de dados com novos sistemas

New items include / Tra le novità / Unter den Neuheiten / Parmi les nouveautés / Entre las novedades / Entre as novidades:

- Anker®
- Assa® Profile AS
- Assa® Profile GM
- Assa® Profile HN
- Assa® Profile NK
- Assa® Profile PK
- Assa® Profile PM
- Assa® Profile PS
- Assa® Profile SH
- Assa® Profile US
- Burg®
- Cisa® Astral Tekno CA
- Cisa® Astral Tekno CE P-S
- Dom® Plura
- Euro Locks®
- Goal® V-18 Master NEW (6+6+6)
- Goal® V-18 Master NEW (7+7+7)
- Iseo® – Dorma® DEC261 SKG
- Iseo® R7 Extra Ricifrabile (Padronale 2)
- Iseo® R7 Extra Cantiere (Cantiere)
- Iseo® R7 Extra Cantiere (Padronale)
- Iseo® R7 Extra Ricifrabile (Cantiere)
- Iseo® R7 Extra Ricifrabile (Padronale 1)
- L&F®
- Mottura® Champions C28 Plus
- Mottura® Champions C39
- Mottura® Champions C43 Plus
- Mottura® Champions Pro CP4 Armo-Riarmo
- Mottura® Champions Pro CP4 Matic
- Mottura® Champions Pro CP4 Riarmo Att-Dis
- Mottura® Champions Pro CP4-CM7
- Nemeff®

 **Remember to update** the Silca.apk and SilcaKeyboard.apk after installing the Software update (see the on board Instructions Manual - Ch. 7.3 APP UPDATE (apk)).

 **Ricordarsi di aggiornare** Silca.apk e SilcaKeyboard.apk dopo l'installazione dell'aggiornamento (vedi le istruzioni nel Manuale d'uso - Cap. 7.3 AGGIORNAMENTO APP (apk)).

 **Behebt Probleme, die beim Software-Update der Maschine** über das Tablet entstehen können. Für mehr Details lesen Sie die Bedienungsanleitung (Kap. 7.3 AKTUALISIERUNG APP (apk)).

 **N'oubliez pas de mettre à jour** Silca.apk et SilcaKeyboard.apk après avoir installé la mise à jour du logiciel (voir le Manuel d'instructions - Ch.7.3 MISE A JOUR APP (apk)).

 **No olvidar actualizar** Silca.apk y SilcaKeyboard.apk después de instalar la versión actualizada del programa (ver indicaciones a bordo máquina integradas en el Manual - Ch 7.3 ACTUALIZACIÓN APP (apk)).

 **Lembrar de atualizar** o Silca.apk eo SilcaKeyboard.apk após a instalação da atualização (ver as instruções no Manual de Utilização - Capítulo 7.3 ATUALIZAÇÃO APP (apk)).



MySilca App - 1.3 version

We remind users of MySilca App that, in order to view the new functions introduced in the 1.3 release, you have to uninstall the previous version of the app and download the new one from Google Play or the App Store.

MySilca App - version 1.3

Nous rappelons aux utilisateurs de MySilca App que, afin de visualiser les nouvelles fonctions introduites dans la version 1.3, vous devez désinstaller la version précédente de l'application et télécharger la nouvelle de Google Play ou de l'App Store.

MySilca App - versione 1.3

Ricordiamo agli utenti di MySilca App che, per poter usufruire delle funzionalità introdotte nella release 1.3, è necessario disinstallare la versione precedente della app e scaricare la nuova versione da Google Play o App Store.

MySilca App - versión 1.3

Recordamos a los usuarios de MySilca App que, con el fin de acceder a las nuevas funciones introducidas en la versión 1.3, hay que desinstalar la versión anterior de la aplicación y descargar la nueva desde Google Play o App Store.

MySilca App - Version 1.3

Wir erinnern die Benutzer von MySilca App, dass sie die vorherige Version der App deinstallieren und die neue Version von Google Play oder App Store herunterladen sollen, um die neuen Funktionen in der 1.3 Version eingeführt zu sehen.

MySilca App - versão 1.3

Nós lembrar os usuários de MySilca App que, a fim de visualizar as novas funções introduzidos na versão 1.3, você tem que desinstalar a versão anterior do aplicativo e baixar a nova versão de Google Play ou App Store.



Click on the links on the right to download MySilca App.
Clicca sui link qui a destra per scaricare MySilca App.
Klicken Sie auf die Links hier rechts um MySilca App herunterzuladen.
Cliquez sur les liens à droite pour télécharger MySilca App.
Clique en los enlaces a la derecha para descargar MySilca App.
Clique nos links à direita para baixar MySilca App.



> More info on all Silca websites



Silca @ ERSI 2016

Bologna (Italy), 15-16 April 2016

The Silca stand



Giacomo Santoro, Silca Head of Marketing, at the class on automotive key duplication



Silca class on cloning and programming devices

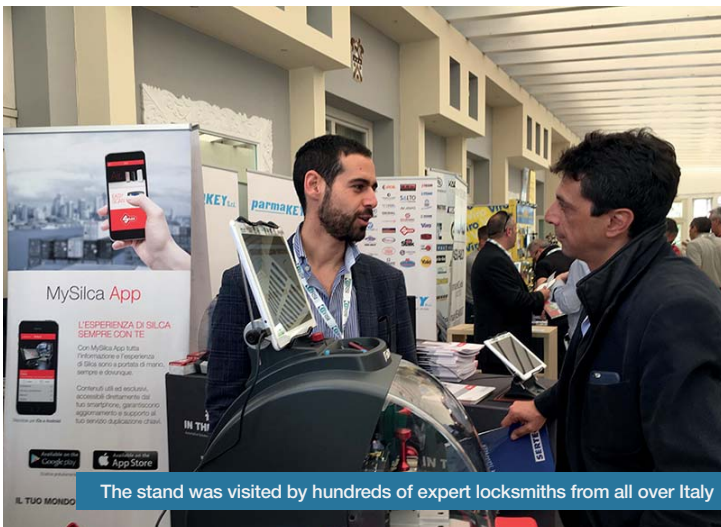

The stand was visited by hundreds of expert locksmiths from all over Italy



Attendees of the stand showed great interest in Unocode Pro and Triax Pro

Sponsorship



UK Silca is proud sponsor of the 2016 edition of artensile.

artensile is the photo contest organized by the La Spezia-based hardware wholesaler Canese Dante srl, whose main goal is to promote the combination of two apparently distant worlds: the hardware and DIY business and the art of photography.

IT Silca è sponsor dell'edizione 2016 di artensile.

artensile è il concorso fotografico organizzato dal ferramenta grossista di La Spezia Canese Dante srl, il cui obiettivo principale è quello di promuovere l'unione tra due mondi apparentemente molto distanti: la ferramenta e l'arte della fotografia.

> More info on artensile.it



SILCA NEWS 06/16

ALL THE NEW KEYS, AUTOMOTIVE SOLUTIONS, KEY CUTTING MACHINES, SOFTWARE UPDATES AND MUCH MORE

Contents

<u>New Keys</u>	1
<u>Vehicle Keys Guide</u>	2-5
<u>Air4 Remotes Catalogue</u>	6
<u>Key Cutting Machine Catalogues</u>	7
<u>SKP - Futura Software Update</u>	8
<u>Key Cutting Machine Accessories</u>	9-10
<u>Silca @ ELF 2016</u>	11





New Keys / Chiavi Nuove / Neue Schlüssel / Nouvelles Clés / Llaves Nuevas / Chaves Nuevas

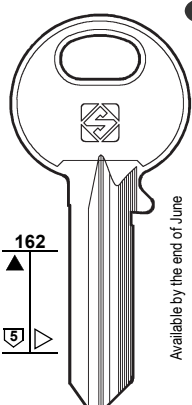
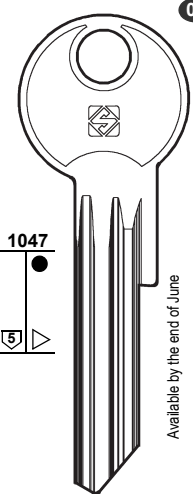
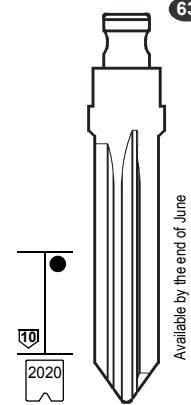
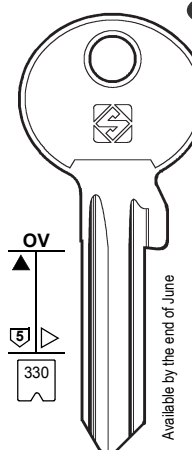
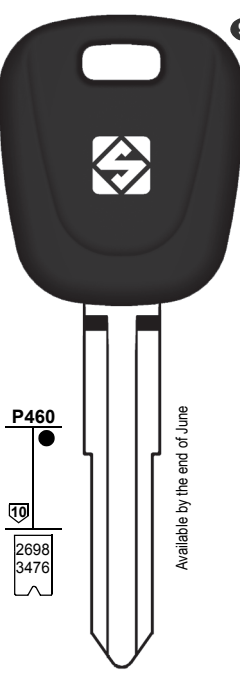
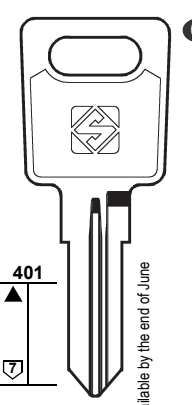
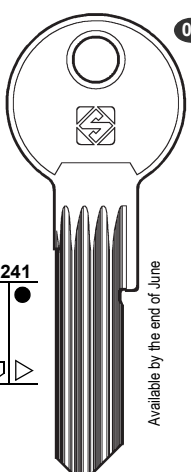
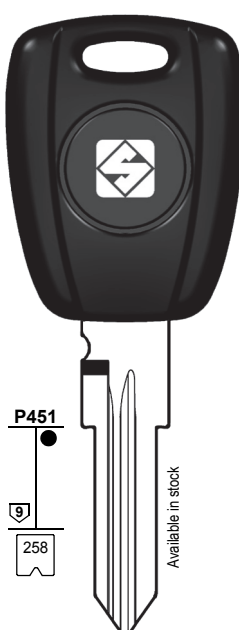















FOR: PER:	ASSA	FAB	GENERAL M.	ISEO	FOR / PER
	 <p>04</p> <p>162</p> <p>5</p> <p>Available by the end of June</p> <p>ASS63R</p>	 <p>04</p> <p>1047</p> <p>5</p> <p>Available by the end of June</p> <p>FB17X</p>	 <p>63</p> <p>2020</p> <p>G 0-3631</p> <p>Available by the end of June</p> <p>B111FH</p>	 <p>04</p> <p>OV</p> <p>5</p> <p>330</p> <p>Available by the end of June</p> <p>LCE 1-17513 Y 1-2000 Y0 1-2000 012345678</p> <p>IE6X</p>	ASSA (SE) FAB (CZ) GENERAL MOTORS (US) ISEO (IT) ISUZU (JP) RONIS (FR) TITAN (SI) TRW SIPEA (IT)
	 <p>96</p> <p>P460</p> <p>10</p> <p>2698 3476</p> <p>Available by the end of June</p> <p>ISU5TE 80000-80999</p>	 <p>04</p> <p>401</p> <p>7</p> <p>Available by the end of June</p> <p>RO85</p>	 <p>04</p> <p>1241</p> <p>5</p> <p>Available by the end of June</p> <p>TN50</p>	 <p>96</p> <p>P451</p> <p>9</p> <p>258</p> <p>Available in stock</p> <p>W 1-9640</p> <p>GT15RTE</p>	<p>01</p> <p>COMMERCIAL GROUP GRUPPO COMMERCIALE PREISEGRUPPE GROUPE COMMERCIAL GRUPO COMMERCIAL GRUPO COMMERCIAL</p> <p>www.silca.biz</p>

ALL THE KEYS DISPLAYED ARE AVAILABLE ALSO IN THE SILCA "NEW KEY COLLECTION"



Car Keys Guide / Guida Chiavi Auto / Marktführer für Autoschlüssel / Guide Clés pour Voitures
 Guía Llaves para Coches / Guia Chaves para Carros

New Updates

1	2	2a	3	3a	3b	E3 / E4 / E2			6	42+71	72	43 44a	12
						TRANSPONDER INFO				IGNITION			
													
CAR MAKE MODEL	FROM	TO	SILCA REF.	SILCA REF.	SILCA REF.	TRANSP. COPY	TRANSP. PROGR.	GEN. ON GTI	TRANSP. TYPE	FAST COPY PLUS RW4 PLUS FAST COPY / RW4	FAST COPY PLUS RW4 PLUS	FAST COPY RW4 + P-BOX/M-BOX	STP
													

For more info on the uses of car keys, refer to the Silca Electronic Key Catalogue:



















AUDI®													
Q3	2011	2014		HU66TE	HU66FH					MEG / CR	48-A2		
Q3	2011	2014	HU66MH	HU66TE	HU66FH	T48				MEG / CR	48-A2	M-BOX	P-BOX,M-BOX
BUICK®													
ENCLAVE	2007		B111-PT		B111FH					PH / CR2	46		
LUCERNE	2006	2011	B111-PT		B111FH					PH / CR2	46		
CADILLAC®													
CTS	2008	2013	B111-PT		B111FH					PH / CR2	46		
DTS	2006	2011	B111-PT		B111FH					PH / CR2	46		
ESCALADE	2007		B111-PT		B111FH					PH / CR2	46		
SRX	2007	2009	B111-PT		B111FH					PH / CR2	46		
STS	2004	2011	B111-PT		B111FH					PH / CR2	46		
XLR	2004	2009	B111-PT		B111FH					PH / CR2	46		
CHEVROLET USA®													
AVALANCHE	2007	2013	B111-PT		B111FH					PH / CR2	46		
COBALT	2006	2010	B111-PT		B111FH					PH / CR2	46		
EQUINOX	2007	2009	B111-PT		B111FH					PH / CR2	46		
EXPRESS	2008	2014	B111-PT		B111FH					PH / CR2	46		
HHR	2006	2011	B111-PT		B111FH					PH / CR2	46		
IMPALA	2006	2013	B111-PT		B111FH					PH / CR2	46		
MALIBU	2004	2012	B111-PT		B111FH					PH / CR2	46		
MONTECARLO	2006	2007	B111-PT		B111FH					PH / CR2	46		
SILVERADO	2007	2013	B111-PT		B111FH					PH / CR2	46		
SUBURBAN	2007	2013	B111-PT		B111FH					PH / CR2	46		
TAHOE	2007	2013	B111-PT		B111FH					PH / CR2	46		
TRAILBLAZER	2006		B111-PT		B111FH					PH / CR2	46		
TRAVERSE	2009		B111-PT		B111FH					PH / CR2	46		
CITROËN®													
C3 PLURIEL	2003	2010	VA2T14	VA2TE	VA6FH		T14	Y		PH / CR2	46		
C3 PLURIEL	2003	2010	VA6MH	VA2TE	VA6FH	GT/MH				PH / CR2	46	Y	P-BOX
FIAT®													
MULTIPLA	1998	2010		GT15RTE						MEG / CR	48		
MULTIPLA	1998	2010	GT15RMH	GT15RTE	GT15RFH	T48				MEG / CR	48	M-BOX	P-BOX,M-BOX
PALIO	2002	2010		GT15RTE						MEG / CR	48		
PALIO	2002	2010	GT15RMH	GT15RTE	GT15RFH	T48				MEG / CR	48	M-BOX	P-BOX,M-BOX



Car Keys Guide / Guida Chiavi Auto / Marktführer für Autoschlüssel / Guide Clés pour Voitures Guía Llaves para Coches / Guia Chaves para Carros

New Updates

1	2	2a	3	3a	3b	E3 / E4 / E2			6	42+71	72	43 44a	12
						TRANSPONDER INFO				IGNITION			
													
CAR MAKE MODEL	FROM	TO	SILCA REF.	SILCA REF.	SILCA REF.	TRANSP. COPY	TRANSP. PROGR.	GEN. ON GTI	TRANSP. TYPE	FAST COPY PLUS RW4 PLUS FAST COPY / RW4	FAST COPY PLUS RW4 PLUS	FAST COPY RW4 + P-BOX/M-BOX	STP
													

For more info on the uses of car keys, refer to the Silca Electronic Key Catalogue:



















FIAT®													
PUNTO	1999	2005		GT15RTE					MEG / CR	48			
PUNTO	1999	2005	GT15RMH	GT15RTE	GT15RFH	T48			MEG / CR	48	M-BOX	P-BOX,M-BOX	
SIENA	2002	2011		GT15RTE					MEG / CR	48			
SIENA	2002	2011	GT15RMH	GT15RTE	GT15RFH	T48			MEG / CR	48	M-BOX	P-BOX,M-BOX	
GMC (GM)®													
ACADIA	2007		B111-PT		B111FH				PH / CR2	46			
DENALI	2007		B111-PT		B111FH				PH / CR2	46			
ENVOY	2007	2009	B111-PT		B111FH				PH / CR2	46			
SAVANA	2008	2013	B111-PT		B111FH				PH / CR2	46			
SIERRA	2007	2013	B111-PT		B111FH				PH / CR2	46			
YUKON	2007		B111-PT		B111FH				PH / CR2	46			
HUMMER®													
H2	2008	2009	B111-PT		B111FH				PH / CR2	46			
H2 SUT	2008	2009	B111-PT		B111FH				PH / CR2	46			
HYUNDAI®													
ACCENT	2011		TOY49MH	TOY49TE	TOY49FH	GTI/MH			PH / CR2	46	Y	P-BOX	
AVANTE	2000	2006	HYN6T14	HYN6TE	HYN6FH		T14	Y	PH / CR2	46			
AVANTE	2000	2006	HYN6MH	HYN6TE	HYN6FH	GTI/MH			PH / CR2	46	Y	P-BOX	
AVANTE	2007	2011	HYN14T14	HYN14TE	HYN14FH		T14	Y	PH / CR2	46			
AVANTE	2007	2011		TOY49TE	TOY49FH		T14	Y	PH / CR2	46			
AVANTE	2007	2011	TOY49MH	TOY49TE	TOY49FH	GTI/MH			PH / CR2	46	Y	P-BOX	
AVANTE	2007	2011	HYN14MH	HYN14TE	HYN14FH	GTI/MH			PH / CR2	46	Y	P-BOX	
LANTRA	2000	2006	HYN6T14		HYN6FH		T14	Y	PH / CR2	46			
LANTRA	2000	2006	HYN6MH		HYN6FH	GTI/MH			PH / CR2	46	Y	P-BOX	
LANTRA	2007	2011			TOY49FH		T14	Y	PH / CR2	46			
LANTRA	2007	2011	TOY49MH		TOY49FH	GTI/MH			PH / CR2	46	Y	P-BOX	
SB11	2011			TOY49TE	TOY49FH		T14	Y	PH / CR2	46			
SB11	2011		TOY49MH	TOY49TE	TOY49FH	GTI/MH			PH / CR2	46	Y	P-BOX	
SOLARIS	2011			TOY49TE	TOY49FH		T14	Y	PH / CR2	46			
SOLARIS	2011		TOY49MH	TOY49TE	TOY49FH	GTI/MH			PH / CR2	46	Y	P-BOX	
STAREX	2007		HYN14T14	HYN14TE	HYN14FH		T14	Y	PH / CR2	46			
STAREX	2007		HYN14MH	HYN14TE	HYN14FH	GTI/MH			PH / CR2	46	Y	P-BOX	
TUCSON	2010	2015	TOY49MH	TOY49TE	TOY49FH	GTI/MH			PH / CR2	46	Y	P-BOX	
VERNA	2011			TOY49TE	TOY49FH		T14	Y	PH / CR2	46			



Car Keys Guide / Guida Chiavi Auto / Marktführer für Autoschlüssel / Guide Clés pour Voitures
 Guía Llaves para Coches / Guia Chaves para Carros

New Updates

1	2	2a	3	3a	3b	E3 / E4 / E2			6	42+71	72	43 44a	12
						TRANSPONDER INFO				IGNITION			
CAR MAKE MODEL	FROM	TO	SILCA REF.	SILCA REF.	SILCA REF.	TRANSP. COPY	TRANSP. PROGR.	GEN. ON GTI	TRANSP. TYPE	FAST COPY PLUS RW4 PLUS FAST COPY / RW4	FAST COPY PLUS RW4 PLUS	FAST COPY RW4 + P-BOX/M-BOX	STP
													
For more info on the uses of car keys, refer to the Silca Electronic Key Catalogue:    													
HYUNDAI®													
VERNA	2011		TOY49MH	TOY49TE	TOY49FH	GTI/MH			PH / CR2	46	Y	P-BOX	
KIA®													
CARENS	2013				TOY49FH				TEX / MA	6E			
OPTIMA	2010	2012	TOY49MH	TOY49TE	TOY49FH	GTI/MH			PH / CR2	46	Y	P-BOX	
RONDO	2013				TOY49FH				TEX / MA	6E			
SPORTAGE	2010	2014		TOY49TE	TOY49FH		T14	Y	PH / CR2	46			
SPORTAGE	2010	2014	TOY49MH	TOY49TE	TOY49FH	GTI/MH			PH / CR2	46	Y	P-BOX	
MITSUBISHI®													
MONTERO	2006	2014			MIT8FH			Y	PH / CR2	46			
MONTERO SPORT	2006	2014			MIT8FH			Y	PH / CR2	46			
MONTERO SPORT	2006	2014	MIT8MH	MIT8TE	MIT8FH	GTI/MH			PH / CR2	46	Y	P-BOX	
NATIVA	2008	2014			MIT8FH			Y	PH / CR2	46			
NATIVA	2008	2014	MIT8MH	MIT8TE	MIT8FH	GTI/MH			PH / CR2	46	Y	P-BOX	
PONTIAC®													
G5	2005	2010	B111-PT		B111FH				PH / CR2	46			
G6	2005	2010	B111-PT		B111FH				PH / CR2	46			
PURSUIT	2006	2010	B111-PT		B111FH				PH / CR2	46			
SOLSTICE	2006	2009	B111-PT		B111FH				PH / CR2	46			
TORRENT	2007	2009	B111-PT		B111FH				PH / CR2	46			
PROTON®													
EXORA	2009	2012							MEG / CR	48			
SATURN (GM)®													
AURA	2007	2010	B111-PT		B111FH				PH / CR2	46			
OUTLOOK	2007	2010	B111-PT		B111FH				PH / CR2	46			
SKY	2007	2010	B111-PT		B111FH				PH / CR2	46			
SUBARU®													
EXIGA	2010	2013	DAT17T21	DAT17TE	DAT17FH		T21	Y	TEX / CR	62			
EXIGA	2010	2013	DAT17MH	DAT17TE	DAT17FH	GTI/MH			TEX / CR	62	Y	P-BOX	
LIBERTY (AUS)	2009	2013	DAT17T21	DAT17TE	DAT17FH		T21	Y	TEX / CR	61			
LIBERTY (AUS)	2009	2013	DAT17MH	DAT17TE	DAT17FH	GTI/MH			TEX / CR	61	Y	P-BOX	
SUZUKI®													
XL-7	2007	2009	B111-PT		B111FH				PH / CR2	46			
TOYOTA® JAPAN													
CROWN	2003	2008	TOY43AT31	TOY43ATE	TOY43FH		T31	Y	TEX / CR	67			

**Car Keys Guide / Guida Chiavi Auto / Marktführer für Autoschlüssel / Guide Clés pour Voitures
Guía Llaves para Coches / Guia Chaves para Carros**

New Updates

1	2	2a	3	3a	3b	E3 / E4 / E2			6	42+71	72	43 44a	12
						TRANSPONDER INFO				IGNITION			
CAR MAKE MODEL	FROM	TO	SILCA REF.	SILCA REF.	SILCA REF.	TRANSP. COPY	TRANSP. PROGR.	GEN. ON GTI	TRANSP. TYPE	FAST COPY PLUS RW4 PLUS FAST COPY / RW4	FAST COPY PLUS RW4 PLUS	FAST COPY RW4 + P-BOX/M-BOX	STP
For more info on the uses of car keys, refer to the Silca Electronic Key Catalogue:													
TOYOTA® JAPAN													
CROWN	2003	2008	TOY43MH	TOY43ATE	TOY43FH	GTI/MH			TEX / CR	67	Y	P-BOX	
MAJESTA	2003	2008	TOY43AT31	TOY43ATE	TOY43FH		T31	Y	TEX / CR	67			
MAJESTA	2003	2008	TOY43MH	TOY43ATE	TOY43FH	GTI/MH			TEX / CR	67	Y	P-BOX	
VOLKSWAGEN®													
GOLF PLUS	2005	2009	HU66T24	HU66TE	HU66FH		T24		MEG / CR	48-A1			
GOLF PLUS	2005	2013	HU66MH	HU66TE	HU66FH	T48			MEG / CR	48-A1	M-BOX	P-BOX,M-BOX	
VOLKSWAGEN® S.AMERICA													
SURAN	2009	2013	HU66T24	HU66TE	HU66FH		T24		MEG / CR	48-A1			
SURAN	2009	2013	HU66MH	HU66TE	HU66FH	T48			MEG / CR	48-A1	M-BOX	P-BOX,M-BOX	

**Truck Keys Guide / Guida Chiavi Camion / Marktführer für LKW Schlüssel
Guide Clés pour Camions / Guía Llaves para Camiones / Guia Chaves para Camiões**

New Updates

1	2	2a	3	3a	3b	E3 / E4 / E2			6	42+71	72	43 44a	12
						TRANSPONDER INFO				IGNITION			
CAR MAKE MODEL	FROM	TO	SILCA REF.	SILCA REF.	SILCA REF.	TRANSP. COPY	TRANSP. PROGR.	GEN. ON GTI	TRANSP. TYPE	FAST COPY PLUS RW4 PLUS FAST COPY / RW4	FAST COPY PLUS RW4 PLUS	FAST COPY RW4 + P-BOX/M-BOX	STP
For more info on the uses of car keys, refer to the Silca Electronic Key Catalogue:													
ISUZU®													
ELF	2009		ISU5MH	ISU5TE		GTI/MH		Y	PH / CR2	46	Y	P-BOX	
F-SERIES	2009		ISU5MH	ISU5TE		GTI/MH		Y	PH / CR2	46	Y	P-BOX	
N-SERIES	2009		ISU5MH	ISU5TE		GTI/MH		Y	PH / CR2	46	Y	P-BOX	

See also the "Vehicle Guide Legend" / Vedi anche la "Legenda Guida Veicoli" / Siehe auch die "Fahrzeugschlüssel Erläuterung" / Voir aussi la "Légende Guide Véhicules" / Véase también la "Leyenda Guía para Vehículos" / Veja também a "Legenda Guia para Veículos"

The uses of the keys are purely indicative and may be subject to updates and revisions. / Gli utilizzi delle chiavi sono da considerarsi puramente indicativi e possono essere oggetto di aggiornamenti e revisioni. / Die Abbildung und technischen Daten der Schlüssel sind nicht bindend. Silca behält sich Änderungen am Produkt, die zur Verbesserung beitragen, vor. / Les usages des clés sont purement indicatifs; ils peuvent être mis à jour et revus. / Los usos de las llaves deben considerarse puramente indicativos y pueden ser objeto de actualizaciones y revisiones. / As utilizações das chaves devem ser consideradas puramente indicativas e podem ser objecto de actualizações e revisões.

© Registered Trademarks. / © Marchi Registrati. / © Eingetragene Marken. / © Marques Déposées. / © Marcas Registradas. / © Marcas Registradas.



Air4 Remotes Catalogue

AIR4 CATALOGUE - VERS. 1

Silca has developed a catalogue to support your residential remote duplication business, presenting the range of Air4 remotes and the Easy Scan device for duplicating them, and includes a list of all the original remote controls that can be duplicated with Air4. In the catalogue you will also find an overview of the main programming procedures for the different types of Air4 remotes (F, V and Q).

Order code: P0QM-1

CATALOGO AIR4 - VERS. 1

Silca ha sviluppato un catalogo a supporto del tuo servizio duplicazione radiocomandi residenziali, che presenta la gamma di radiocomandi Air4 e il dispositivo Easy Scan, utilizzato per la loro duplicazione, e contiene una lista di radiocomandi originali che possono essere duplicati con Air4. Nel catalogo sono inoltre riassunte le principali procedure di programmazione delle diverse tipologie di Air4 (F, V e Q).

Codice: P0QM-1

AIR4 KATALOG - VERS. 1

Silca hat einen Katalog entwickelt, um Ihren Service von Funkfernbedienungen im Wohnbereich zu unterstützen. Der Katalog präsentiert die Funkfernbedienungen Air4 und das Gerät Easy Scan, das Sie durch das Kopierverfahren der Air4 führt, und enthält eine Liste von Original-Fernbedienungen, die mit Air4 dupliziert werden können. Im Katalog finden Sie auch die wichtigsten Programmierverfahren der verschiedenen Typen von Air4 (F, V und Q).

Code: P0QM-1

CATALOGUE AIR4 - VERS. 1

Silca a développé un catalogue pour soutenir votre service de reproduction de télécommandes à usage domestique, qui présente la gamme de Air4 et le dispositif Easy Scan, utilisé pour leur duplication, et contient une liste des télécommandes originales qui peuvent être reproduites avec Air4. Dans le catalogue, il y a aussi un résumé des principales procédures de programmation des différents types de Air4 (F, V et Q).

Code: P0QM-1

CATÁLOGO AIR4 - VERS. 1

Silca ha desarrollado un catálogo en apoyo de su servicio de duplicación de mandos a distancia residenciales, que presenta la gama de mandos Air4 y el dispositivo Easy Scan, utilizado para duplicarlos, y contiene una lista de los mandos a distancia originales que pueden ser duplicados con Air4. En el catálogo también se resumen los principales procedimientos de programación de los diferentes tipos de Air4 (F, V y Q).

Código: P0QM-1

CATÁLOGO AIR4 - VERS. 1

Silca desenvolveu um catálogo para apoiar o seu serviço de duplicação de rádio controlos residenciais, que apresenta a gama de Air4 eo dispositivo Easy Scan, usado para duplicá-los, e contém uma lista de rádio controlos originais que podem ser duplicados com Air4. No catálogo também estão resumidos os principais procedimentos de programação dos diferentes tipos de Air4 (F, V e Q).

Código: P0QM-1



> More info on all Silca websites



Key Cutting Machine Catalogues

🇬🇧 KEY MACHINE CATALOGUES

The updated catalogues presenting the Silca range of mechanical and electronic key cutting machines, cloning and programming devices for vehicle keys, reading and marking devices are now available in print and online on all Silca websites.

Mechanical key machines: **P0BP-5**
Electronic machines and devices: **P0BV-5**

🇩🇪 SCHLÜSSELMASCHINENKATALOGE

Die aktualisierten Kataloge der Silca Palette von mechanischen und elektronischen Schlüsselfräsmaschinen, Kopier- und Programmiergeräte für Fahrzeugschlüssel, Lese- und Gravurmaschinen sind im Druck und online auf allen Silca Websites verfügbar.

Mechanische Maschinen: **P0BL-5**
Elektronische Maschinen und Geräte: **P0BS-5**

🇪🇸 CATÁLOGOS DUPLICADORAS

Los catálogos actualizados de las máquinas duplicadoras mecánicas y electrónicas, de los dispositivos de clonación y programación de llaves de vehículo, de los dispositivos de lectura y grabado están disponibles en forma impresa y en línea en todos los sitios Silca.

Máquinas electrónicas y dispositivos: **P0BT-5**
Máquinas mecánicas: **P0BM-5**

🇮🇹 CATALOGHI DUPLICATRICI

Sono disponibili in forma cartacea e online su tutti i siti Silca i cataloghi aggiornati relativi alla gamma di duplicatrici meccaniche ed elettroniche, dispositivi di clonazione e programmazione chiavi veicolo, dispositivi di lettura e incisione.

Macchine meccaniche: **P0BQ-5**
Macchine elettroniche e dispositivi: **P0BW-5**

🇫🇷 CATALOGUES MACHINES

Les nouveaux catalogues des machines à tailler les clés mécaniques et électroniques, des dispositifs de clonage et de programmation de clés de véhicules, des dispositifs de lecture et gravure sont disponibles en version imprimée et en ligne sur tous les sites Silca.

Machines électroniques et dispositifs: **P0BU-5**
Machines mécaniques: **P0BN-5**

🇵🇹 CATÁLOGOS DUPLICADORAS

Os catálogos atualizados de duplicadoras mecânicas e eletrônicas, de dispositivos de clonagem e de programação de chaves do veículo, de dispositivos de leitura e incisão estão agora disponíveis em versão impressa e on-line em todos os sites Silca.

Máquinas eletrônicas e dispositivos: **P0BX-5**
Máquinas mecânicas: **P0BR-5**

> More info on all Silca websites

Silca Key Programs - WEB Update

SKP - WEB UPDATE

A new update of the SILCA KEY PROGRAMS software is available to all WEB subscribers.

Check out the "News" section of Silca Key Programs on www.silca.biz to know more.

SKP - MISE À JOUR WEB

Une nouvelle mise à jour du logiciel SILCA KEY PROGRAMS pour tous les abonnements WEB est disponible.

Consultez la section "Nouveautés" de Silca Key Programs sur notre site www.silca.biz pour en savoir plus.

SKP - AGGIORNAMENTO WEB

È disponibile un nuovo aggiornamento del software SILCA KEY PROGRAMS per tutti gli abbonati WEB.

Consulta la sezione "Novità" di Silca Key Programs sul sito www.silca.biz per saperne di più.

SKP - ACTUALIZACIÓN WEB

Una nueva actualización del software SILCA KEY PROGRAMS para todos los abonados WEB está disponible.

Visite la sección "Novedades" de Silca Key Programs en el sitio www.silca.biz para más informaciones.

SKP - AKTUALISIERUNG WEB

Für alle WEB Abonnenten ist eine neue Aktualisierung von der Software SILCA KEY PROGRAMS verfügbar.

Sehen Sie den Abschnitt "Neuheiten" von Silca Key Programs auf www.silca.biz, um weitere Informationen zu finden.

SKP - ATUALIZAÇÃO WEB

Nova atualização do software SILCA KEY PROGRAMS para todos o assinantes WEB está disponível.

Consulte a seção "Novidades" de Silca Key Programs no site www.silca.biz para saber mais.

SILCA FUTURA PROGRAM

Data Update with new systems

Software Vers. 2.18.0 - db 3.03

App Vers. 1.21



Futura

Data update with new systems / Aggiornamento dati con nuovi sistemi / Datenaktualisierung mit neuen Systemen / Mise à jour des données avec nouveaux systèmes / Actualización de datos con sistemas nuevos / Atualização de dados com novos sistemas

New items include / Tra le novità / Unter den Neuheiten / Parmi les nouveautés / Entre las novedades / Entre as novidades:

- | | | |
|--------------------|--------------------|---------------------------------------|
| - ESP® | - Oxloc® O8,2 | - Oxloc® O9,3 |
| - Goal® GP (6+6+6) | - Oxloc® O8,2 (4P) | - Volkswagen® - Škoda® HU162T (4T-8W) |
| - Goal® GP (7+7+7) | - Oxloc® O8,3 | |
| - Hudson® | - Oxloc® O8,3 (4P) | |
| - MG® (Monti) | - Oxloc® O9,2 | |

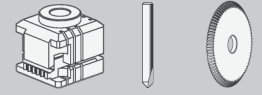
Accessories / Accessori / Zubehör / Accessoires / Accesorios / Acessórios

 FOR:
PER:

HUF (DE)

HU162T
(4T - 8W)

VOLKSWAGEN
SKODA

FUTURA

> SW Futura 2.18



QUATTROCODE

TRIAX PRO
TRIAX QUATTRO

OPTIONAL

D746461ZB
56J Jaw
Ganascia 56J
56J Backe
Mâchoire 56J
Quijada 56J
Garra 56J

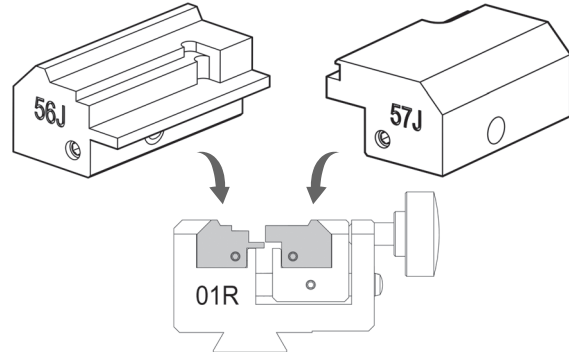
OPTIONAL

D746467ZB
57J Jaw
Ganascia 57J
57J Backe
Mâchoire 57J
Quijada 57J
Garra 57J

OPTIONAL

D743671ZB
Cutter 02L
Fresa 02L
Fräser 02L
Fraise 02L
Fresa 02L
Fresa 02L

OPTIONAL

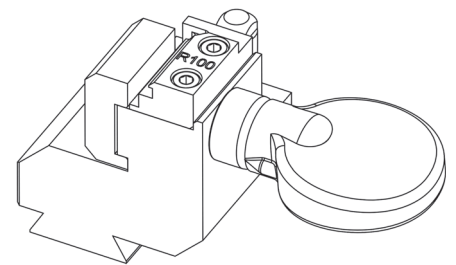
D746455ZB
Clamp R100
Morsetto R100
Spannbacke R100
Étau R100
Mordaza R100
Mordente R100

OPTIONAL

D709481ZB
Cutter H114
Fresa H114
Fräser H114
Fraise H114
Fresa H114
Fresa H114

D709482ZB
Cutter W114
Fresa W114
Fräser W114
Fraise W114
Fresa W114
Fresa W114

 Starting from SKP Software version 21.0.4.54
 Dalla versione Software SKP 21.0.4.54
 Ab SKP Software Version 21.0.4.54
 À partir du software SKP version 21.0.4.54
 Desde software SKP versión 21.0.4.54
 A partir da versão software SKP 21.0.4.54

FOR:
PER:

KABA (CH)

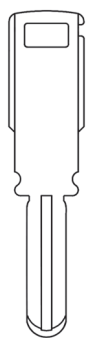

(KABA Exper T)

System protected by a password issued by Silca on receipt of authorization.

Sistema protetto da password rilasciata da Silca a fronte di autorizzazione.

Passwort geschütztes System - Freigabe des Herstellers erforderlich.

Système protégé par un password qui est émis par Silca sur autorisation.

Sistema protegido por password que expide Silca contra autorización.

Sistema protegido por uma password emitida por Silca contra a autorização.



FUTURA

> SW Futura 2.19

OPTIONAL



NEW

D746713ZB

*Clamp 05R
Morsetto 05R
Spannbacke 05R
Etau 05R
Mordaza 05R
Mordente 05R*

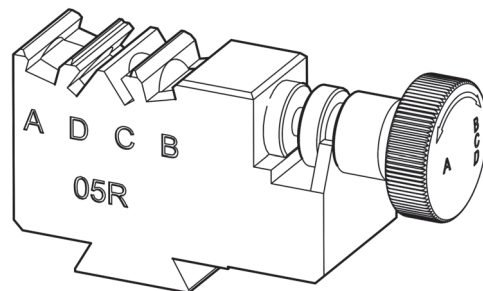

NEW

OPTIONAL



D746736ZB

*Cutter 10D
Fresa 10D
Fräser 10D
Fraise 10D
Fresa 10D
Fresa 10D*

Delivery time JULY 2016
Disponibilità LUGLIO 2016
Lieferbar JULI 2016
Disponibilité JUILLET 2016
Disponibilidad JULIO 2016
Disponibilidade JULHO 2016



Silca @ ELF 2016

Copenhagen (Denmark), 18-22 May 2016





Great presence of Silca, Dorma and Kaba at the ELF Convention held in Copenhagen. Silca Automotive ID48 solution, the new Triax Pro and Unocode Pro have been collecting positive comments from Danish specialists and international visitors. Silca Protech has attracted both specialists and exhibitors, interested in the new features of this unique semi-industrial key cutting centre.

Security Essen 27-30.09.2016

The world's leading fair for security and fire prevention



 Silca is attending the Security Essen, taking place in Essen (Germany), from 27th to 30th September 2016. **Come visit us at Booth 12B04, Hall 12.**

 Silca parteciperà a Security Essen, che si terrà ad Essen (Germania), dal 27 al 30 Settembre 2016. **Vieni a visitarci allo Stand 12B04, Padiglione 12.**

 Silca wird an der Security Essen, die vom 27. bis 30. September 2016 in Essen (Deutschland) veranstaltet wird, teilnehmen. **Besuchen Sie uns am Stand 12B04, Halle 12.**

 Silca participera à Security Essen, qui se tiendra à Essen (Allemagne), du 27 au 30 septembre 2016. **Venez nous visiter au Stand 12B04, Pavillon 12.**

 Silca asistirá a Security Essen, que tendrá lugar en Essen (Alemania), del 27 al 30 de Septiembre de 2016. **Venga a visitarnos en el Stand 12B04, Pabellón 12.**

 Silca participará do Security Essen, que será realizada em Essen (Alemanha), de 27 a 30 Setembro 2016. **Venha visitar-nos no Estande 12B04, Pavilhão 12.**

> Save the date



SILCA NEWS 07/16

ALL THE NEW KEYS, AUTOMOTIVE SOLUTIONS, KEY CUTTING MACHINES, SOFTWARE UPDATES AND MUCH MORE

Contents

<u>New Keys</u>	1-2
<u>Vehicle Keys Guide</u>	3-4
<u>Key Cutting Machine Accessories</u>	5
<u>ID48: Now More Cracking Power</u>	6
<u>Omnia 650rpm</u>	7
<u>Silca Key Programs Update</u>	8-11
<u>ADS209 Ford® Bypass Software</u>	12-13
<u>Worldwide AD Releases</u>	14-22





New Keys / Chiavi Nuove / Neue Schlüssel / Nouvelles Clés / Llaves Nuevas / Chaves Nuevas





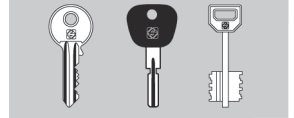



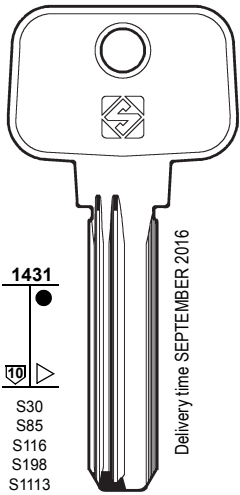

FOR: PER:	BAILING LOCK	CINA	EURO LOCKS	FOR / PER
	<p>04</p> <p>Delivery time JULY 2016</p> <p>BNL1R</p> <p>T-KEY</p>	<p>02 17</p> <p>625 1000</p> <p>Delivery time AUGUST 2016 Delivery time AUGUST 2016</p> <p>RC12R RC13R</p>	<p>06</p> <p>P487</p> <p>Delivery time JULY 2016</p> <p>EU22RP</p> <p>HOBBY</p>	BAILING LOCK (CN) T-KEY CINA (CN) EURO LOCKS (BE) HOBBY FAB (CZ) HOBBY (GB) EURO LOCKS (1) MAUER (BG) MUL.T.LOCK (IL)
FOR: PER:	FAB	MAUER	MUL.T.LOCK	
	<p>02 02</p> <p>55 11</p> <p>Delivery time AUGUST 2016 Delivery time AUGUST 2016</p> <p>FB103 FB104R</p>	<p>04</p> <p>1305</p> <p>Delivery time JULY 2016</p> <p>MAU5R</p>	<p>06</p> <p>1431</p> <p>8.8</p> <p>S29</p> <p>Delivery time SEPTEMBER 2016</p> <p>MTK2 (006) ABCD-12345</p>	
				01 COMMERCIAL GROUP GRUPPO COMMERCIALE PREISGRUPPE GROUPE COMMERCIAL GRUPO COMMERCIAL GRUPO COMERCIAL www.silca.biz

ALL THE KEYS DISPLAYED ARE AVAILABLE ALSO IN THE SILCA "NEW KEY COLLECTION"

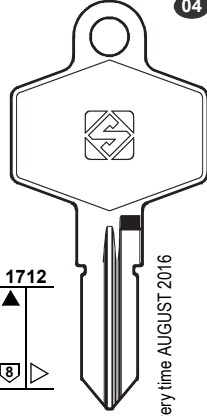

New Keys / Chiavi Nuove / Neue Schlüssel / Nouvelles Clés / Llaves Nuevas / Chaves Nuevas

FOR / PER
MUL.T.LOCK (IL)
RENZ (DE)
T-KEY (CN)
BAILING LOCK (1)

FOR: PER:	MUL.T.LOCK	RENZ
	 <p>1431</p> <p> S30 S85 S116 S198 S1113</p> <p>Delivery time SEPTEMBER 2016</p> <p>05  MTK11 (005) ABCD-12345</p> <p> MTK10R (006) ABCD-12345-01</p> <p>50  MTK7R (006) ABCD-12345-01</p> <p>64  MTK8R (006) ABCD-12345-01</p> 	 <p>1712</p> <p> S</p> <p>Delivery time AUGUST 2016</p> <p> REN6</p> <p> REN6R</p>

FOR: PER:

01

COMMERCIAL GROUP
GRUPPO COMMERCIALE
PREISEGRUPPE
GROUPE COMMERCIAL
GRUPO COMMERCIAL
GRUPO COMERCIAL

















www.silca.biz

ALL THE KEYS DISPLAYED ARE AVAILABLE ALSO IN THE SILCA "NEW KEY COLLECTION"



Car Keys Guide / Guida Chiavi Auto / Marktführer für Autoschlüssel / Guide Clés pour Voitures
 Guía Llaves para Coches / Guia Chaves para Carros

New Updates

1	2	2a	3	3a	3b	E3 / E4 / E2			6	42+71	72	43 44a	12
						TRANSPONDER INFO				IGNITION			
CAR MAKE MODEL	FROM	TO	SILCA REF.	SILCA REF.	SILCA REF.	TRANSP. COPY	TRANSP. PROGR.	GEN. ON GTI	TRANSP. TYPE	FAST COPY PLUS RW4 PLUS FAST COPY / RW4	FAST COPY PLUS RW4 PLUS	FAST COPY RW4 + P-BOX/M-BOX	STP
													
For more info on the uses of car keys, refer to the Silca Electronic Key Catalogue:    													
AUDI®													
Q3	2011	2014	HU66MH	HU66TE	HU66FH	T48			MEG / CR	48-A2	M-BOX	P-BOX,M-BOX	
CITROËN®													
C3 PLURIEL	2003	2010	VA6MH	VA2TE	VA6FH	GTI/MH			PH / CR2	46	Y	P-BOX	
HOBBY (CARAVAN)®													
VARIOUS MODELS			EU21P										
VARIOUS MODELS			EU22RP										
HYUNDAI®													
ACCENT	2011		TOY49MH	TOY49TE	TOY49FH	GTI/MH			PH / CR2	46	Y	P-BOX	
AVANTE	2000	2006	HYN6T14	HYN6TE	HYN6FH		T14	Y	PH / CR2	46			
AVANTE	2000	2006	HYN6MH	HYN6TE	HYN6FH	GTI/MH			PH / CR2	46	Y	P-BOX	
AVANTE	2007	2011		TOY49TE	TOY49FH		T14	Y	PH / CR2	46			
AVANTE	2007	2011	HYN14T14	HYN14TE	HYN14FH		T14	Y	PH / CR2	46			
AVANTE	2007	2011	HYN14MH	HYN14TE	HYN14FH	GTI/MH			PH / CR2	46	Y	P-BOX	
AVANTE	2007	2011	TOY49MH	TOY49TE	TOY49FH	GTI/MH			PH / CR2	46	Y	P-BOX	
LANTRA	2000	2006	HYN6T14		HYN6FH		T14	Y	PH / CR2	46			
LANTRA	2000	2006	HYN6MH		HYN6FH	GTI/MH			PH / CR2	46	Y	P-BOX	
LANTRA	2007	2011			TOY49FH		T14	Y	PH / CR2	46			
LANTRA	2007	2011	TOY49MH		TOY49FH	GTI/MH			PH / CR2	46	Y	P-BOX	
SOLARIS	2011			TOY49TE	TOY49FH		T14	Y	PH / CR2	46			
SOLARIS	2011		TOY49MH	TOY49TE	TOY49FH	GTI/MH			PH / CR2	46	Y	P-BOX	
KIA®													
RONDO	2013				TOY49FH				TEX / MA	6E			
MITSUBISHI®													
ECLIPSE (USA)	2002	2005							TEX / CR	61			
ENDEAVOR	2004	2007							PH / CR2	46			
ENDEAVOR	2004	2007	EK3P-MIT16						PH / CR2	46	Y	P-BOX	
MONTERO	2001	2006	MIT8T19	MIT8TE	MIT8FH		T19	Y	TEX / CR	61			
MONTERO	2001	2006	MIT8MH	MIT8TE	MIT8FH	GTI/MH			TEX / CR	61	Y	P-BOX	
MONTERO SPORT	2006	2014			MIT8FH			Y	PH / CR2	46			
MONTERO SPORT	2006	2014	MIT8MH	MIT8TE	MIT8FH	GTI/MH			PH / CR2	46	Y	P-BOX	
NATIVA	2008	2014			MIT8FH			Y	PH / CR2	46			
NATIVA	2008	2014	MIT8MH	MIT8TE	MIT8FH	GTI/MH			PH / CR2	46	Y	P-BOX	
NISSAN®													
JUKE	2010	2014	NSN14T14	NSN14TE	NSN14FH		T14	Y	PH / CR2	46			

Car Keys Guide / Guida Chiavi Auto / Marktführer für Autoschlüssel / Guide Clés pour Voitures
 Guía Llaves para Coches / Guia Chaves para Carros

New Updates

1	2	2a	3	3a	3b	E3 / E4 / E2			6	42+71	72	43 44a	12
						TRANSPONDER INFO				IGNITION			
CAR MAKE MODEL	FROM	TO	SILCA REF.	SILCA REF.	SILCA REF.	TRANSP. COPY	TRANSP. PROGR.	GEN. ON GTI	TRANSP. TYPE	FAST COPY PLUS RW4 PLUS FAST COPY / RW4	FAST COPY PLUS RW4 PLUS	FAST COPY RW4 + P-BOX/M-BOX	STP

For more info on the uses of car keys, refer to the Silca Electronic Key Catalogue:

NISSAN®													
MICRA	2003	2010							PH / CR2	46			
MICRA	2010	2014	NSN14T14	NSN14TE	NSN14FH		T14	Y	PH / CR2	46			
MICRA	2010		SMART KEY						PH / CR2	46			
MICRA	2014				NSN14FH				PH / CR2	46			
SUBARU®													
EXIGA	2010	2013	DAT17MH	DAT17TE	DAT17FH	GTI/MH			TEX / CR	62	Y	P-BOX	
LIBERTY (AUS)	2009	2013	DAT17MH	DAT17TE	DAT17FH	GTI/MH			TEX / CR	61	Y	P-BOX	
TOYOTA JAPAN®													
CROWN	2003	2008	TOY43AT31	TOY43ATE	TOY43FH		T31	Y	TEX / CR	67			
MAJESTA	2003	2008	TOY43MH	TOY43ATE	TOY43FH	GTI/MH			TEX / CR	67	Y	P-BOX	
VOLKSWAGEN®													
GOLF PLUS	2005	2009	HU66T24	HU66TE	HU66FH		T24		MEG / CR	48-A1			
GOLF PLUS	2005	2013	HU66MH	HU66TE	HU66FH	T48			MEG / CR	48-A1	M-BOX	P-BOX,M-BOX	
VOLKSWAGEN® SUD AMERICA													
SURAN	2009	2013	HU66T24	HU66TE	HU66FH		T24		MEG / CR	48-A1			

See also the "Vehicle Guide Legend" / Vedi anche la "Legenda Guida Veicoli" / Siehe auch die "Fahrzeugschlüssel Erläuterung" / Voir aussi la "Légende Guide Véhicules" / Véase también la "Leyenda Guía para Vehículos" / Veja também a "Legenda Guia para Veículos"

The uses of the keys are purely indicative and may be subject to updates and revisions. / Gli utilizzi delle chiavi sono da considerarsi puramente indicativi e possono essere oggetto di aggiornamenti e revisioni. / Die Abbildung und technischen Daten der Schlüssel sind nicht bindend. Silca behält sich Änderungen am Produkt, die zur Verbesserung beitragen, vor. / Les usages des clés sont purement indicatifs; ils peuvent être mis à jour et revus. / Los usos de las llaves deben considerarse puramente indicativos y pueden ser objeto de actualizaciones y revisiones. / As utilizações das chaves devem ser consideradas puramente indicativas e podem ser objecto de actualizações e revisões.

© Registered Trademarks. / © Marchi Registrati. / © Eingetragene Marken. / © Marques Déposées. / © Marcas Registradas. / © Marcas Registradas.

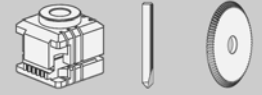
Accessories / Accessori / Zubehör / Accessoires / Accesorios / Acessórios

FOR:
PER:

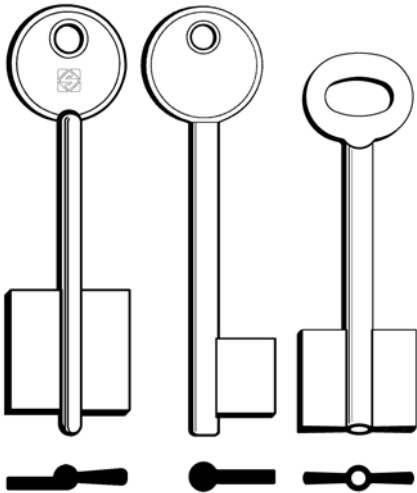

OMNIA
OMNIA 650rpm
OMNIA MAX
OMNIA W MAX

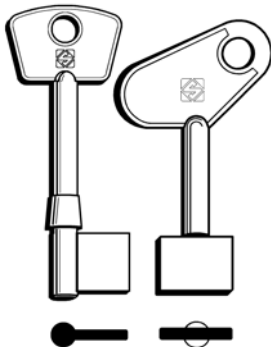

STANDARD
OMNIA
OMNIA MAX

OPTIONAL
OMNIA 650rpm
OMNIA W MAX

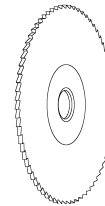

D741777ZB
Cutter HSS TiN coated
Fresa HSS rivestimento TiN
Fräser HSS TiN Beschichtung
Fraise HSS revêtement TiN
Fresa HSS revestimiento TiN
Fresa HSS revestimento TiN

FOR: **Brass keys - Chiavi in ottone - Messingschlüssel**
PER: **Clés en laiton - Llaves de latón - Chaves de latão**

STANDARD
OMNIA 650rpm

OPTIONAL
OMNIA
OMNIA MAX
OMNIA W MAX

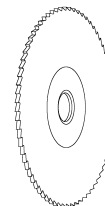

D700080ZB
Cutter HSS
Fresa HSS
Fräser HSS
Fraise HSS
Fresa HSS
Fresa HSS

FOR: **Steel and brass keys - Chiavi in acciaio e ottone**
PER: **Stahl- und Messingschlüssel - Clés en acier et laiton**
Llaves de acero y latón - Chaves de aço e latão

STANDARD
OMNIA W MAX

OPTIONAL
OMNIA
OMNIA 650rpm
OMNIA MAX

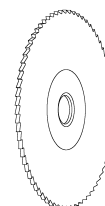

D704784ZB
Carbide cutter
Fresa in metallo duro
Fräser Hartmetall
Fraise au carbure
Fresa de metal duro
Fresa de metal duro

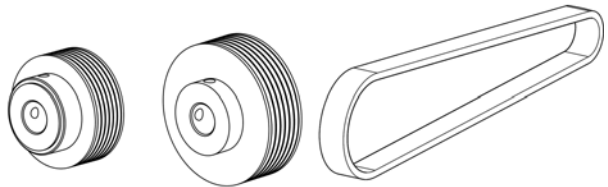

D745201ZB
Pulley set 1050 rpm
Set pulegge 1050 rpm
Satz Riemenscheiben 1050 rpm
Jeu de poulies 1050 rpm
Set poleas 1050 rpm
Set polias 1050 rpm

Delivery time JULY 2016
Disponibilità LUGLIO 2016
Lieferbar JULI 2016
Disponibilité JUILLET 2016
Disponibilidad JULIO 2016
Disponibilidade JULHO 2016





SILCA ID48 SOLUTION Now with more cracking power



More info on the Silca ID48 Solution available in the dedicated brochure.

Order your copy now:

- Silca ID48 Brochure (EN): P0QP
- Silca ID48 Depliant (IT): P0QN
- Silca ID48 Broschüre (DE): P0QQ
- Silca ID48 Brochure (FR): P0QR
- Silca ID48 Folleto (ES): P0QS
- Silca ID48 Fôlhetto (PT): P0QW
- Silca ID48 Brochure (NL): P0QT

> More info on all Silca websites

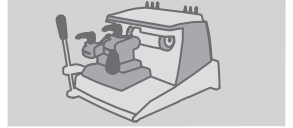

Omnia 650rpm



Smooth and effortless carriage movements



HSS cutter able to reach a speed of 650 rpm

🇬🇧 Omnia 650rpm

Omnia 650rpm is the professional key cutting machine for duplicating bit and double bit (male and female), pump and central stop keys. Featuring a speed of 650rpm, it is perfect for key cutters and locksmiths who duplicate mainly brass keys.

- Cross table for smooth carriage movements.
- HSS cutter able to reach a speed of 650rpm.
- Self-centering clamps with different offset.
- Spring-loaded tracer point with micrometric regulation.
- Inclined plane and led lighting.

🇮🇹 Omnia 650rpm

Omnia 650rpm è la macchina duplicatrice professionale per chiavi a mappa e doppia mappa (maschio e femmina), con fermo centrale e chiavi a pompa. Caratterizzata da una velocità di 650 giri/min, è perfetta per duplicatori e specialisti che tagliano prevalentemente chiavi in ottone.

- Tavola a croce per movimenti del carrello fluidi.
- Fresa in HSS con velocità di 650 giri/min.
- Morsetti sfalsati con sistema di bloccaggio chiavi autocentrante.
- Tastatore molleggiato con regolazione micrometrica.
- Piano inclinato e illuminazione a led.

🇩🇪 Omnia 650rpm

Omnia 650rpm ist die professionelle Maschine für gebohrte und ungebohrte Bart- und Doppelbartschlüssel, Schlüssel mit Halman-schlag und Pumpenschlüssel. Omnia 650rpm bietet eine Geschwindigkeit von 650 U/min und eignet sich perfekt für Schlüsselprofis die vorwiegend Messingschlüssel fräsen.

- Kreuztisch für mühelose Bewegungen des Frässhittens.
- Fräser aus HSS - Geschwindigkeit von 650 U/min.
- Spannbacken mit selbstzentrierender Schlüsselbefestigung.
- Tasterfederung mit mikrometrischer Regulierung.
- Schräge Arbeitsfläche und Led-Beleuchtung.

🇫🇷 Omnia 650rpm

Omnia 650rpm est la machine professionnelle pour reproduire les clés à panneton et double panneton (mâles et femelles), les clés à pompes et à butée centrale. Caractérisée par une vitesse de 650 rpm, elle est idéale pour les clés-minute qui taillent surtout des clés en laiton.

- Plateau en croix pour des mouvements du chariot fluides.
- Fraise en HSS qui atteint une vitesse de 650 rpm.
- Étaux décalés à système de blocage des clés autocentrante.
- Palpeur sur ressorts à régulation micrométrique.
- Plan incliné et éclairage led.

🇪🇸 Omnia 650rpm

Omnia 650rpm es la máquina duplicadora profesional para llaves de pala y doble pala (macho y hembra), llaves con tope central y llaves frontales. Caracterizada por una velocidad de 650 r.p.m. resulta perfecta para duplicadores y especialistas que cortan llaves de latón sobre todo.

- Tabla de cruz para movimientos fluidos del carro.
- Fresa de HSS con velocidad de 650 r.p.m.
- Mordazas con sistema de bloqueo de llaves autocentrante y desalineadas en altura.
- Palpador de resorte con regulación micrométrica.
- Plano inclinado e iluminación de led.

🇵🇹 Omnia 650rpm

Omnia 650rpm é a duplicadora profissional para chaves de palhetão e duplo palhetão (macho e fêmea), com encosto central e chaves de bomba. Caracterizada por uma velocidade de 650 r.p.m. é perfeita para profissionais da duplicação que cortam sobretudo chaves de latão.

- Mesa em cruz para movimentos fluidos do carro.
- Fresa em HSS com velocidade de 650 r.p.m.
- Mordentes com sistema de bloqueio de chaves de centragem automática.
- Palpador com suspensão com regulação micrométrica.
- Plano inclinado e iluminação led.

> More info on www.silca.biz



Silca Key Programs

Update 2/2016 - SKP Vers. 21.1.x.xx

UPDATE 2/2016

New SKP 2/2016 Update for all WEB and DVD subscribers available in the "News" section of Silca Key Programs. New items include:

- Updated comparative list.
- Improved the pre-setting system of T12 on T28 with the TRP Setting program.

MISE À JOUR 2/2016

Nouvelle mise à jour SKP 2/2016 pour tous les abonnés WEB et DVD disponible dans la section "Nouveautés" de Silca Key Programs.

Parmi les nouveautés:

- Mise à jour des comparatifs.
- Amélioration du système de pré-codage du T12 sur le T28 avec le programme TRP Setting.

AGGIORNAMENTO 2/2016

Nuovo Aggiornamento SKP 2/2016 per tutti gli abbonati WEB e DVD consultabile nella sezione "Novità" di Silca Key Programs.

Tra le novità:

- Aggiornamento dei comparativi.
- Migliorato il sistema di pre-settaggio del T12 sul T28 con il programma TRP Setting.

ACTUALIZACIÓN 2/2016

Nueva actualización SKP 2/2016 para todos los abonados WEB y DVD disponible en la sección "Novedades" de Silca Key Programs.

Entre las novedades:

- Actualizado el comparativo.
- Mejorado el sistema de preajuste del T12 en el T28 con el programa TRP Setting.

AKTUALISIERUNG 2/2016

Die Informationen zur neuen Aktualisierung des SKP 2/2016 für alle WEB und DVD Abonnenten ist in der Sektion "Neuheiten" des Silca Key Programs verfügbar.

Unter den Neuheiten:

- Aktualisierte Vergleichsliste.
- Verbessert das T12 Voreinstellung System auf den T28 mit dem TRP Program.

ATUALIZAÇÃO 2/2016

Nova atualização SKP 2/2016 para todos o assinantes WEB e DVD disponível na seção "Novidades" de Silca Key Programs.

Entre as novidades:

- Atualizado os comparativos.
- Melhorado o sistema de pré-ajuste do chip T12 no chip T28 através do programa transponder.

> More info on all Silca websites

SILCA CODE PROGRAM

Data Update with 19 new cutting cards

SKP Vers. 21.1.x.xx



UC199



Unocode 299/399



Unocode 399 Evo



Unocode Pro

Data update with 19 new cutting cards / Aggiornamento dati con 19 nuove schede / Datenaktualisierung mit 19 neuen Karten / Mise à jour des données avec 19 nouvelles fiches / Actualización datos con 19 fichas nuevas / Atualização de dados com 19 fichas novas.

New items include / Tra le novità / Unter den Neuheiten / Parmi les nouveautés / Entre las novedades / Entre as novidades:

- Abus® 83
- Abus® U72
- Abus® U74
- Bema® RF-360
- Hudson®
- MG® (Monti®) Chiave normale 4P
- MG® (Monti®) Chiave normale 5P
- MG® (Monti®) Chiave simmetrica 6P
- MG® (Monti®) Chiave ridotta 5P
- Pfaffenhain® (S5+)



Update the software on / Aggiornare il software di / Aktualisierung der Software von / Mettre à jour le logiciel de / Actualizar el software de / Atualizar o software de: UC199, Unocode 299, Unocode 399, Unocode 399 Evo, Unocode Pro.

SILCA VIPER PROGRAM

Data Update with 4 new series

SKP Vers. 21.1.x.xx



Viper

Data update with 4 new series / Aggiornamento dati con 4 nuove serie / Daten-Aktualisierung mit 4 neuen Serien / Mise à jour des données avec 4 nouvelles séries / Actualización datos con 4 nuevas series / Atualização de dados com 4 novas séries.

New items include / Tra le novità / Unter den Neuheiten / Parmi les nouveautés / Entre las novedades / Entre as novidades:

- Abus® U72
- Abus® U74
- Kia® (2T - 8W)
- Volvo® XC90 (2T - 8W)



Update the software on / Aggiornare il software di / Aktualisierung der Software von / Mettre à jour le logiciel de / Actualizar el software de / Atualizar o software de: Viper.

SILCA TRIAX - QUATTROCODE PROGRAM

Data Update with 35 new series

SKP Vers. 21.1.x.xx



Quattrocode



Triax e-code



Triax Quattro



Triax Pro

Data update with 35 new series / Aggiornamento dati con 35 nuove serie / Daten-Aktualisierung mit 35 neuen Serien / Mise à jour des données avec 35 nouvelles séries / Actualización datos con 35 nuevas series / Atualização de dados com 35 novas séries.

New items include / Tra le novità / Unter den Neuheiten / Parmi les nouveautés / Entre las novedades / Entre as novidades:

- Cisa® Astral Tekno CA
- Cisa® Astral Tekno CA (Special Profiles)
- Cisa® Astral Tekno CE P-S
- Cisa® Astral Tekno CE P-S (Special Profiles)
- Codem® (5P)
- Dorma® DEC261 SKG
- Federal® UCF3100
- Goal® GP (6+6+6)
- Goal® GP (7+7+7)
- HU162T (4T-8W)
- Iseo® R7 Extra Cantiere (Cantiere)
- Iseo® R7 Extra Cantiere (Padronale)
- Iseo® R7 Extra Ricifrabile (Cantiere)
- Iseo® R7 Extra Ricifrabile (Padronale 1)
- Iseo® R7 Extra Ricifrabile (Padronale 2)
- Kia® (2T- -8W) (*)
- Mottura® Champions C28 Plus
- Mottura® Champions C39
- Mottura® Champions C43 Plus (5+5)
- Mottura® Champions Pro CP4 Armo-Riarmo
- Mottura® Champions Pro CP4 Matic
- Mottura® Champions Pro CP4 Riarmo Att-Dis
- Mottura® Champions Pro CP4-CM7
- Oxloc® O8,2 (4P)
- Oxloc® O8,3 (4P)
- Oxloc® O9,2
- Oxloc® O9,3
- Ronis® (5P)
- Titan® I6 (6P)
- Trelock® InX M2 (4T-4W) (*)
- Trelock® InX ML2 (4T-4W) (*)
- Volvo® XC90 (2T - 8W)
- Yardeni® 6 Master-Cut tip
- Yardeni® 6 Master-No cut tip
- Yardeni® 6 Regular-Cut tip



Update the software on / Aggiornare il software di / Aktualisierung der Software von / Mettre à jour le logiciel de / Actualizar el software de / Atualizar o software de: Triax e-code, Triax Quattro, Triax Pro.

ATTENTION: TRIAX E-CODE and TRIAX 2 machine internal memory is full:

- All new systems will only be added to SKP and not into the machine.
- The lock systems with the asterisk (*) are not available in the Silca Key Programs.

ATTENTION: La mémoire interne de la machine TRIAX E-CODE et TRIAX 2 est pleine:

- Les nouveaux systèmes seront intégrés dans le SKP et non dans la machine.
- Les systèmes serrures avec astérisques (*) ne sont pas présents dans SKP.

ATTENZIONE: La memoria interna delle duplicatrici TRIAX E-CODE e TRIAX 2 è completa:

- I nuovi sistemi serratura saranno inseriti solo nel SKP e non a bordo macchina.
- I sistemi serratura con asterisco (*) non sono presenti in Silca Key Programs.

ATENCIÓN: La memoria interna de la duplicadora TRIAX E -CODE e TRIAX 2 esta llena:

- Los nuevos sistemas deben ser insertados solo en el SKP y no a bordo maquina.
- Los sistemas de cerradura con el asterisco (*) no están disponibles en el SKP.

VORSICHT: Bei den Maschinen TRIAX E-CODE und TRIAX 2 ist der interne Speicher voll:

- Alle neuen Systeme werden nur im SKP hinzugefügt jedoch nicht in der Maschine.
- Die Schlosssysteme mit dem Sternchen (*) sind nicht im Silca Key Programm verfügbar.

ATENÇÃO: A memória interna das máquinas TRIAX E-CODE e TRIAX 2 está cheia:

- Todos os novos sistemas, serão adicionados ao SKP e não à máquina.
- Os sistemas de fechaduras com asterisco (*) não estão disponíveis em SKP.

SILCA TRANSPONDER PROGRAM

Data Update with 59 new vehicle applications

SKP Vers. 21.1.x.xx



RW4 Plus / RW4

 **Silca Transponder Program has been updated with 59 new vehicle applications.**

- New software version 4.02.086 for all RW devices (RW4, RW4 Plus, Fast Copy, Fast Copy Plus).
- New software version 1.0.11 for M-Box.

 **Il Silca Transponder Program è stato aggiornato con 59 nuove applicazioni auto.**

- Nuova versione software 4.02.086 per tutti i dispositivi RW (RW4, RW4 Plus, Fast Copy, Fast Copy Plus).
- Nuova versione software 1.0.11 per M-Box.



Fast Copy Plus / Fast Copy

 **Das Silca Transponder Program wurde mit 59 neuen Auto-Applikationen aktualisiert.**

- Neue Softwareversion 4.02.086 für alle RW-Geräte (RW4, RW4 Plus, Fast Copy, Fast Copy Plus).
- Neue Softwareversion 1.0.11 für M-Box.

 **Silca Transponder Program a été mis à jour avec 59 nouvelles applications auto.**

- Nouvelle version logiciel 4.02.086 pour tous les dispositifs transpondeur (RW4, RW4 Plus, Fast Copy, Fast Copy Plus).
- Nouvelle version logiciel 1.0.11 pour M-Box.



M-Box

 **Se ha actualizado el Silca Transponder Program con 59 nuevas aplicaciones vehículo.**

- Nueva versión de software 4.02.086 para todos los dispositivos RW (RW4, RW4 Plus, Fast Copy, Fast Copy Plus).
- Nueva versión de software 1.0.11 para M-Box.

 **O Silca Transponder Program foi atualizado com 59 novas aplicações para automóvel.**

- Nova versão de software 4.02.086 para todos os dispositivos RW (RW4, RW4 Plus, Fast Copy, Fast Copy Plus).
- Nova versão de software 1.0.11 para M-Box.



Update the software on / Aggiornare il software di / Aktualisierung der Software von / Mettre à jour le logiciel de / Actualizar el software de / Atualizar o software de: RW4, RW4 Plus, Fast Copy, Fast Copy Plus.

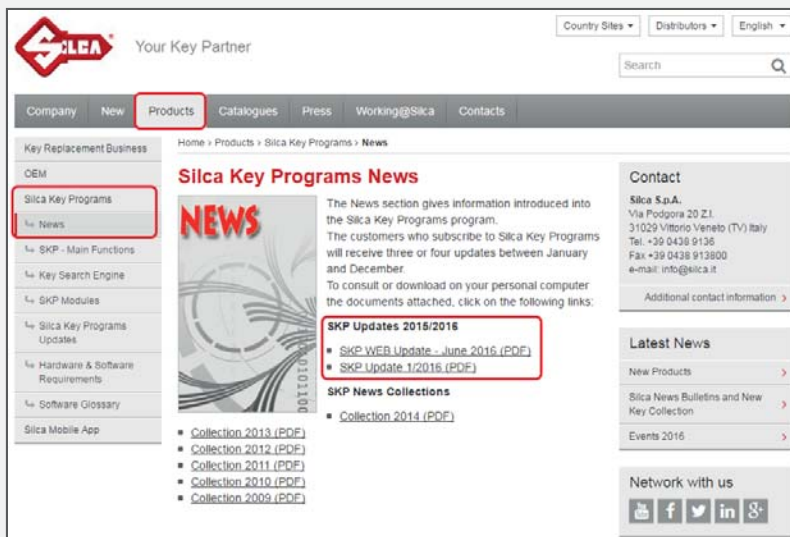

The screenshot shows the Silca website interface. The 'Products' menu is highlighted. The main content area is titled 'Silca Key Programs News' and contains the following information:

- SKP Updates 2015/2016**
 - SKP WEB Update - June 2016 (PDF)
 - SKP Update 1/2016 (PDF)
- SKP News Collections**
 - Collection 2013 (PDF)
 - Collection 2012 (PDF)
 - Collection 2011 (PDF)
 - Collection 2010 (PDF)
 - Collection 2009 (PDF)

Additional elements visible include a search bar, navigation tabs (Company, New, Products, Catalogues, Press, Working@Silca, Contacts), and a contact information section for Silca S.p.A.

> Complete and updated info available on all Silca websites



New Software Release for Ford® vehicles Ford® Bypass ADS209 - Code D747568AD For proximity and bladed keys on selected Ford® vehicles

July 2016



United Kingdom: Advanced Diagnostics is pleased to announce the release of ADS209 Ford® 20 byte bypass for the latest Ford® vehicles worldwide. ADS209 key programming software is designed to bypass the security without a dealer login.

Italy: Advanced Diagnostics ha sviluppato il software ADS209 “bypass 20 byte” per i più recenti veicoli Ford® diffusi in tutto il mondo. Il software consente di bypassare un protocollo di sicurezza utilizzato su alcuni veicoli Ford® senza doversi necessariamente rivolgere ad un concessionario autorizzato.



Germany: Advanced Diagnostics hat die neue Software ADS209 Ford® „20 byte bypass“ für neuere Ford® Fahrzeugmodelle entwickelt. ADS209 ermöglicht es einen Code zu berechnen, mit dem ein Sicherheitsprotokoll bei einigen Ford®-Fahrzeugen umgangen werden kann. Dank dieser Lösung müssen Sie sich nicht mehr an einen Vertrags-händler wenden, um den spezifischen Sicherheitscode zu bekommen.

France: Advanced Diagnostics a développé le logiciel ADS209 Ford® “bypass 20 byte” pour les derniers véhicules Ford® en circulation dans le monde entier. Le logiciel ADS209 permet de contourner un protocole de sécurité utilisé sur certains véhicules Ford® sans s’adresser à un concessionnaire autorisé.

Spain: Advanced Diagnostics ha desarrollado un nuevo software “ADS209 Ford® Bypass 20 bytes” para los últimos vehículos de Ford® comercializados en todo el mundo. El software de programación ADS209 está diseñado para saltarse la seguridad de los vehículos sin necesidad de usar el código de acceso del concesionario.

Brazil: A Advanced Diagnostics desenvolveu o novo software ADS209 Ford® “bypass 20 byte” para os últimos veículos Ford® difundidos em todo o mundo. O software ADS209 permite calcular um código para efectuar o bypass do protocolo de segurança em alguns veículos Ford® sem dirigir-se a um concessionário autorizado.

OFFER DETAILS

Cable	ADG250 or ADG251
Dongle	Smart Dongle
Software category	A
Other software required	ADS222
Smart card	Smart Dongle

© All the brands and product names mentioned in this flyer are registered trademarks exclusive property of authorized manufacturers. Said trademarks or trade names are nominated only for the purposes of information in order to be rapidly identified.



www.silca.biz - www.silca-automotive.com - www.advanced-diagnostics.com



Software Applications

Ford® Bypass ADS209

TABLE

							
Mondeo (Proximity & Blade) 2015 Onwards	✓	✓	✗	✗	ADC250 or ADC251	Smart Dongle	✗
S-Max (Proximity) 2015 Onwards	✓	✓	✗	✗	ADC250 or ADC251	Smart Dongle	✗
Galaxy (Proximity) 2015 Onwards	✓	✓	✗	✗	ADC250 or ADC251	Smart Dongle	✗
Mustang (Proximity) 2015 Onwards	✓	✓	✗	✗	ADC250 or ADC251	Smart Dongle	✗
Edge (Proximity) 2016 Onwards	✓	✓	✗	✗	ADC250 or ADC251	Smart Dongle	✗
Vignale (Proximity) 2015 Onwards	✓	✓	✗	✗	ADC250 or ADC251	Smart Dongle	✗

Important Note: To Prevent damage to the Smart Dongle, ensure that the ignition is turned off when connecting the tester to the vehicle.

Nota importante: per prevenire eventuali danni al dispositivo Smart Dongle, assicurarsi che il motore sia spento nel momento in cui il dispositivo di programmazione viene collegato al veicolo.

Wichtiger Hinweis: um mögliche Schäden am Smart Dongle zu vermeiden, verbinden Sie das Programmiergerät nur bei ausgeschaltetem Motor an das Fahrzeug.

Remarque importante: pour prévenir d'éventuels dégâts sur le dispositif Smart Dongle, assurez-vous que le moteur soit éteint au moment où le dispositif de programmation est connecté au véhicule.

Nota importante: para prevenir cualquier daño al Smart Dongle, asegúrese de que el contacto está apagado cuando conecte el dispositivo de programación al vehículo.

Anotação importante: para prevenir eventuais danos no dispositivo Smart Dongle, certificar-se de que o motor está desligado no momento em que o dispositivo de programação é ligado ao veículo.

© All the brands and product names mentioned in this flyer are registered trademarks exclusive property of authorized manufacturers. Said trademarks or trade names are nominated only for the purposes of information in order to be rapidly identified.



Worldwide Advanced Diagnostics Releases May 2015 - May 2016

New Software Releases

SOFTWARE NAME	PART NUMBER	REGION	CATEGORY	RELEASE DATE	FLYER
Subaru® Proximity	ADS228	North America	C	May 2015	Click here
PSA® Pin Read	ADS229	Worldwide	B	July 2015	Click here
Toyota® 2015 (USA)	ADS227	North America	A	July 2015	Click here
Nissan® Pin Read (Smart Dongle)	ADS198SD	Worldwide	SPECIALS	September 2015	Click here
Chevrolet® Pincode Read (SAM)	ADS246	South America	A	October 2015	Click here
Fiat® 2015	ADS231	Worldwide	C	November 2015	Click here
Suzuki® 2015 (India)	ADS233	India	C	November 2015	Click here
Nissan® (SAM)	ADS249	South America	C	December 2015	Click here
Fiat® (SAM)	ADS247	South America	A	December 2015	Click here
Hyundai® - Kia® Pincode (Smart Dongle)	ADS190SD	Worldwide	SPECIALS	January 2016	Click here
Mazda® 2016	ADS225	Worldwide	A	March 2016	Click here

Free Software Updates

SOFTWARE NAME	PART NUMBER	REGION	CATEGORY	RELEASE DATE	FLYER
Ford® Coded	ADS222	Worldwide	A	June 2015	Click here
Toyota® Smart Reset	ADS199	North America	B	December 2015	Click here
Ford®	ADS100	South America	A	December 2015	Click here

New Product and Accessory Releases

PRODUCT NAME	PART NUMBER	REGION	RELEASE DATE	USER GUIDE	FLYER
Smart Aerial	ADC242	Worldwide	November 2015	Click here	Click here
ADC243 Power Cable	ADC243	Worldwide	January 2016	N/A	Click here
VAG® Cluster Reset Cable	ADC219	Worldwide	May 2016	Click here	Click here

© All the brands and product names mentioned in this flyer are registered trademarks exclusive property of authorized manufacturers. Said trademarks or trade names are nominated only for the purposes of information in order to be rapidly identified.

www.silca.biz - www.silca-automotive.com - www.advanced-diagnostics.com



Key Programming New Vehicles Added to Software and IQ

September 2015 - 166 Vehicles Added

In September we restructured the Toyota® / Lexus® menus, enabling you to select by vehicle. Below are the new vehicles that have been added to software and IQ for September 2015.

Europe

MAKE	MODEL	SOFTWARE
Lexus®	SC430 - 2001 to 2005 (Blade)	ADS125
Lexus®	RX450h - 2009 to 2012 (Proximity)	ADS150
Lexus®	IS220 - 2005 to 2008 (Proximity)	ADS150
Toyota®	Hilux - 2011 Onwards (Blade)	ADS174
Toyota®	Auris - 2007 to 2009 (Blade)	ADS125
Toyota®	Auris - 2009 to 2012 (Blade)	ADS150
Toyota®	Avensis - 2006 to 2008 (Blade)	ADS125
Toyota®	Corolla - 2001 to 2004 (Blade)	ADS125
Toyota®	Avensis - 2008 to 2011 (Blade)	ADS150
Toyota®	MR2 - 2002 to 2005 (Blade)	ADS125
Toyota®	Verso - 2012 Onwards (Blade)	ADS174
Toyota®	Rav 4 - 2005 to 2008 (Blade)	ADS150
Toyota®	Proace - 2013 Onwards (Blade)	ADS142
Toyota®	Yaris - 2001 to 2003 (Blade)	ADS125
Toyota®	Avensis - 1997 to 2000 (Blade)	ADS125
Toyota®	Land Cruiser - 2009 to 2013 (Blade)	ADS174
Toyota®	IQ - 2008 to 2014 (Blade)	ADS174
Toyota®	Rav4 - 2010 to 2012 (Blade)	ADS174
Toyota®	Rav4 - 2010 to 2012 (Proximity)	ADS150
Toyota®	Prius - 2003 to 2009 (Slot)	ADS150
Toyota®	Yaris - 2005 to 2009 (Blade)	ADS125

Europe

MAKE	MODEL	SOFTWARE
Toyota®	Auris - 2010 (Proximity)	ADS150
Toyota®	Rav4 - 2005 to 2008 (Proximity)	ADS150
Toyota®	Corolla - 2010 to 2013 (Blade)	ADS125
Toyota®	Yaris - 2006 to 2008 (Proximity)	ADS150
Toyota®	Landcruiser - 2009 - 2013 (Proximity)	ADS150
Toyota®	Avensis - 2011 Onwards (Blade)	ADS174
Toyota®	Prius - 2009 to 2011 (Proximity)	ADS174
Toyota®	Avensis - 2000 to 2002 (Blade)	ADS125
Toyota®	Rav 4 - 2003 to Oct 2005 (Blade)	ADS125
Toyota®	Yaris - 2008 to 2011 (Blade)	ADS125/ ADS150
Toyota®	Auris - 2007 to 2009 (Blade)	ADS125
Toyota®	Avensis - 2008 to 2011 (Blade)	ADS125
Toyota®	Corolla - 2008 to 2009 (Blade)	ADS125
Toyota®	Camry - 2006 to 2009 (Blade)	ADS150
Toyota®	Yaris - 2011 Onwards (Blade)	ADS174/ ADS150
Toyota®	Verso - 2010 to 2012 (Blade)	ADS174/ ADS150
Toyota®	Corolla 2004 to 2007 (Proximity)	ADS150
Toyota®	Avensis 2008 to 2011 (Proximity)	ADS150
Toyota®	Hilux - 2008 to 2011 (Blade)	ADS174
Toyota®	Auris 2010 Onwards (Blade)	ADS174
Toyota®	Aygo 2005 to 2014 (Blade)	ADS125

© All the brands and product names mentioned in this flyer are registered trademarks exclusive property of authorized manufacturers. Said trademarks or trade names are nominated only for the purposes of information in order to be rapidly identified.

www.silca.biz - www.silca-automotive.com - www.advanced-diagnostics.com



Key Programming New Vehicles Added to Software and IQ

September 2015 - Continued

USA

MAKE	MODEL	SOFTWARE
Lexus®	IS250 - 2014 to 2015 (Proximity)	ADS227
Lexus®	IS350 - 2014 to 2015 (Proximity)	ADS227
Lexus®	GS350 - 2007 to 2011 (Proximity)	ADS150
Lexus®	RX350 - 2012 Onwards (Proximity)	ADS174
Lexus®	RX450h - 2012 Onwards (Proximity)	ADS174
Lexus®	LS460 - 2012 Onwards (Proximity)	ADS174
Lexus®	RX400h - 2005 to 2008 (Blade)	ADS125
Lexus®	RX300 - 1999 to 2003 (Blade)	ADS125
Lexus®	GS430 2006 to 2010 (Proximity)	ADS150
Lexus®	GS350 - 2014 Onwards (Proximity)	ADS174
Lexus®	GS430 - 2005 to 2006 (Proximity)	ADS150
Lexus®	CT200h - 2010 Onwards (Proximity)	ADS174
Lexus®	LS600h - 2007 to 2008 (Proximity)	ADS150
Lexus®	IS250 - 2010 Onwards (Proximity)	ADS150
Lexus®	ES330 - 2004 to 2006 (Blade)	ADS125
Lexus®	ES350 - 2005 to 2007 (Proximity)	ADS150
Lexus®	GS300 - 2005 to 2007 (Proximity)	ADS150
Lexus®	GS350 - 2006 to 2013 (Proximity)	ADS150
Lexus®	GX460 - 2010 to 2011 (Proximity)	ADS174
Lexus®	HS250h - 2009 to 2011 (Proximity)	ADS174
Lexus®	IS250 - 2006 to 2010 (Proximity)	ADS150

USA

MAKE	MODEL	SOFTWARE
Lexus®	LS430 - 2004 to 2006 (Proximity)	ADS125
Lexus®	RX350 - 2010 to 2013 (Proximity)	ADS174
Lexus®	RX450h - 2010 to 2011 (Proximity)	ADS174
Lexus®	IS350 - 2006 to 2013 (Proximity)	ADS174
Toyota®	Tacoma - 2011 Onwards (Blade)	ADS174
Toyota®	Matrix 2005 to 2007 (Blade)	ADS125
Toyota®	Matrix 2007 to 2010 (Blade)	ADS174
Toyota®	Prius C - 2012 2013 (Blade)	ADS174/ ADS150
Toyota®	Yaris - 2013 (Blade)	ADS174
Toyota®	Tundra - 2009 to 2013 (Blade)	ADS174/ ADS150
Toyota®	Tundra - 2013 Onwards (Blade)	ADS174/ ADS150
Toyota®	Avalon - 2013 to 2014 (Proximity)	ADS174
Toyota®	Corolla - 2009 to 2011(Proximity)	ADS150
Toyota®	Highlander - 2010 to 2013 (Blade)	ADS174/ ADS150
Toyota®	Highlander - 2008 to 2010 (Blade)	ADS150
Toyota®	Highlander V6 - 2004 to 2007 (Blade)	ADS125
Toyota®	Matrix - 2010 to 2013 (Blade)	ADS174/ ADS150
Toyota®	Rav 4 - 2011 to 2012 (Proximity)	ADS174
Toyota®	Rav 4 - 2007 to 2011 (Blade)	ADS150
Toyota®	Rav 4 - 2010 to 2012 (Blade)	ADS174/ ADS150
Toyota®	Solara - 2004 to 2006 (Blade)	ADS125

© All the brands and product names mentioned in this flyer are registered trademarks exclusive property of authorized manufacturers. Said trademarks or trade names are nominated only for the purposes of information in order to be rapidly identified.

www.silca.biz - www.silca-automotive.com - www.advanced-diagnostics.com



Key Programming New Vehicles Added to Software and IQ

September 2015 - Continued

USA

MAKE	MODEL	SOFTWARE
Lexus®	Tacoma - 2011 to 2013 (Blade)	ADS174
Lexus®	Yaris - 2007 (Blade)	ADS125
Lexus®	Yaris 2012 to 2013 (Blade)	ADS174
Toyota®	4 Runner - 2001 to 2002 (Blade)	ADS125
Toyota®	4 Runner - 2003 to 2009 (Blade)	ADS125
Toyota®	Avalon - 2005 to 2007 (Blade)	ADS125
Toyota®	Avalon - 2008 to 2012 (Blade)	ADS150
Toyota®	Corolla - 2005 to 2006 (Blade)	ADS125
Toyota®	Corolla - 2007 to 2011 (Blade)	ADS150
Toyota®	Highlander - 2001 to 2003 (Blade)	ADS174
Toyota®	Highlander LE - 2007 (Proximity)	ADS150
Toyota®	Land Cruiser 2001 to 2007 (Blade)	ADS125
Toyota®	Land Cruiser - 2008 to 2010 (Proximity)	ADS150
Toyota®	Matrix - 2005 to 2006 (Blade)	ADS125
Toyota®	Rav 4 - 2004 to 2005 (Blade)	ADS125
Toyota®	Sequoia - 2001 to 2002 (Blade)	ADS125
Toyota®	Sequoia - 2008 to 2010 (Blade)	ADS150
Toyota®	Sequoia - 2011 to 2013 (Blade)	ADS174
Toyota®	Solara 4 CYL - 2002 to 2003 (Blade)	ADS125
Toyota®	Tacoma - 2005 to 2007 (Blade)	ADS174
Toyota®	4 Runner - 2010 to 2014 (Blade)	ADS174/ ADS150

USA

MAKE	MODEL	SOFTWARE
Toyota®	4 Runner - 2010 to 2014 (Proximity)	ADS174
Toyota®	Corolla - 2007 to 2011 (Blade)	ADS150
Toyota®	FJ Cruiser - 2008 to 2010 (Blade)	ADS150
Toyota®	Highlander - 2008 to 2014 (Proximity)	ADS150
Toyota®	Matrix - 2008 to 2010 (Blade)	ADS150
Toyota®	Rav 4 - 2006 (Blade)	ADS150
Toyota®	Rav 4 - 2009 to 2010 (Proximity)	ADS150
Toyota®	Tacoma - 2008 to 2010 (Blade)	ADS150
Toyota®	Tundra - 2007 to 2009 (Blade)	ADS150
Toyota®	Tundra - 2009 to 2013 (Blade)	ADS174/ ADS150
Toyota®	Venza - 2009 (Blade)	ADS150
Toyota®	Yaris - 2008 to 2011 (Blade)	ADS150
Toyota®	Camry Hybrid - 2012 to 2014 (Proximity)	ADS174
Toyota®	Corolla - 2010 to 2013 (Blade)	ADS174/ ADS150
Toyota®	FJ Cruiser- 2011 to 2013 (Blade)	ADS150/ ADS174
Toyota®	Prius - 2010 to 2014 (Proximity)	ADS174
Toyota®	Venza - 2010 to 2013 (Blade)	ADS174/ ADS150
Toyota®	Venza Hybrid - 2009 to 2012 (Proximity)	ADS174
Toyota®	Prius - 2009 to 2011 (Proximity)	ADS174
Toyota®	Rav 4 - 2011 to 2012 (Proximity)	ADS174

© All the brands and product names mentioned in this flyer are registered trademarks exclusive property of authorized manufacturers. Said trademarks or trade names are nominated only for the purposes of information in order to be rapidly identified.



Key Programming New Vehicles Added to Software and IQ

September 2015 - Continued

Asia

MAKE	MODEL	SOFTWARE
Lexus®	ES350 - 2006 to 2009 (Proximity)	ADS150
Toyota®	Land Cruiser - 1999 to 2002 (Blade)	ADS125
Toyota®	Voxy (Proximity)	ADS150
Toyota®	Reiz - 2009 (Blade)	ADS150
Toyota®	Celsior - 2000 to 2006 (Blade)	ADS125
Toyota®	Corolla - 2003 to 2006 (Blade)	ADS125
Toyota®	Corolla - 2010 - (Blade)	ADS174
Toyota®	Prius - 2011 (Proximity)	ADS174
Toyota®	Mark X - 2006 (Proximity)	ADS125/ ADS150
Toyota®	Camry Hybrid - 2012 (Proximity)	ADS174
Toyota®	Crown - 2003 to 2008 (Blade)	ADS125
Toyota®	Highlander 2010 Onwards (Blade)	ADS174
Toyota®	Camry - 2006 to 2011 (Proximity)	ADS150
Toyota®	Aurion 2006 to 2011 (Blade)	ADS125
Toyota®	Corolla Fielder - 2006 to 2011 (Prox.)	ADS150
Toyota®	Corolla Rumion - 2006 to 2011 (Prox.)	ADS150
Toyota®	Kluger - 2006 to 2011 (Proximity)	ADS150
Toyota®	Premio - 2006 to 2011 (Proximity)	ADS150

Africa

MAKE	MODEL	SOFTWARE
Toyota®	Corolla 2007 to 2009 (Blade)	ADS125
Toyota®	Land Cruiser - 2007 to 2013 (Prox.)	ADS150
Toyota®	Land Cruiser - 2002 to 2009 (Blade)	ADS150
Toyota®	Aygo - 2005 Onwards (Blade)	ADS125

Australia

MAKE	MODEL	SOFTWARE
Toyota®	Camry - 2011 Onwards (Blade)	ADS150
Toyota®	Vanguard - 2009 Onwards (Proximity)	ADS150
Toyota®	Land Cruiser - 2012 Onwards (Prox.)	ADS150
Toyota®	Land Cruiser - 2005 to 2007 (Blade)	ADS125
Toyota®	Land Cruiser 100 - 1998 to 2002 (Blade)	ADS125
Toyota®	Camry - 2006 Onwards (Blade)	ADS150
Toyota®	Aurion - 2009 Onwards (Blade)	ADS174
Toyota®	Camry - 2009 Onwards (Blade)	ADS174
Toyota®	Hiace - 2009 Onwards (Blade)	ADS174
Toyota®	Kluger - 2009 (Blade)	ADS174
Toyota®	Land Cruiser 70 - 2009 (Blade)	ADS174
Toyota®	Tarago - 2009 Onwards (Blade)	ADS174
Toyota®	Yaris - 2009 Onwards (Blade)	ADS174

India

MAKE	MODEL	SOFTWARE
Toyota®	Land Cruiser - 2007 to 2011 (Prox.)	ADS150
Toyota®	Land Cruiser - 2004 to 2009 (Blade)	ADS125

Israel

MAKE	MODEL	SOFTWARE
Toyota®	300h - 2013 (Proximity)	ADS174
Toyota®	Rav 4 - 2012 (Blade)	ADS199
Toyota®	Auris - 2010 (Proximity)	ADS150
Toyota®	Camry Hybrid - 2006 to 2009 (Prox.)	ADS150

© All the brands and product names mentioned in this flyer are registered trademarks exclusive property of authorized manufacturers. Said trademarks or trade names are nominated only for the purposes of information in order to be rapidly identified.

www.silca.biz - www.silca-automotive.com - www.advanced-diagnostics.com



Key Programming New Vehicles Added to Software and IQ

October 2015 - 25 Vehicles Added

Australia

MAKE	MODEL	SOFTWARE
Subaru®	Forester - 2009 to 2011 (Blade)	ADS127
Subaru®	Impreza - 1997 to 1999 (Blade)	ADS127
Subaru®	Tribeca - 2006 to 2012 (Blade)	ADS127
Subaru®	Tribeca - 2006 (Proximity)	ADS127

Israel

MAKE	MODEL	SOFTWARE
Subaru®	Impreza - 2008 (Proximity)	ADS224
Toyota®	Outback - 2008 (Proximity)	ADS224
Toyota®	B4 - 2009 (Proximity)	ADS224

USA

MAKE	MODEL	SOFTWARE
Subaru®	Forester - 2012 to 2013 (Blade)	ADS228
Subaru®	Impreza WRX 2013	ADS127
Subaru®	Legacy - 2014 (Blade)	ADS127/ ADS228
Subaru®	Outback - 2013 to 2015 (Blade)	ADS127/ ADS228
Subaru®	BRZ - 2013 to 2015 (Proximity)	ADS227
Subaru®	BRZ - 2013 to 2015 (Blade)	ADS227
Subaru®	Forester - 2009 to 2012 (Blade)	ADS127
Subaru®	Impreza HS Key - 2008 to 2012 (Blade)	ADS127
Subaru®	Impreza Not HS Key - 2008 to 2012 (Blade)	ADS127
Subaru®	Legacy - 2010 to 2013 (Blade)	ADS127
Subaru®	Forester XT - 2005 to 2008 (Blade)	ADS127
Subaru®	Outback XT - 2005 (Blade)	ADS127

Europe

MAKE	MODEL	SOFTWARE
Subaru®	Legacy - up to 2009 (Blade)	ADS127
Subaru®	Impreza Hatchback Type 2 (Blade)	ADS127
Subaru®	Impreza Hatchback Type 3 (Blade)	ADS127
Subaru®	Impreza STI - 2008 to 2012 (Prox.)	ADS127
Subaru®	Tribeca - up to 2007 (Proximity)	ADS127
Subaru®	Impreza Hatchback Type 1 (Blade)	ADS127

© All the brands and product names mentioned in this flyer are registered trademarks exclusive property of authorized manufacturers. Said trademarks or trade names are nominated only for the purposes of information in order to be rapidly identified.

www.silca.biz - www.silca-automotive.com - www.advanced-diagnostics.com



Key Programming New Vehicles Added to Software and IQ

November 2015 - 8 Vehicles Added

Africa

MAKE	MODEL	SOFTWARE
Toyota®	Fortuner - 2009 (Blade)	ADS174

Asia

MAKE	MODEL	SOFTWARE
Mitsubishi®	Delica - 2007 to 2015 (Proximity)	ADS154
Mitsubishi®	Delica - 2007 (Blade)	ADS154

Europe

MAKE	MODEL	SOFTWARE
Vauxhall®	Corsa E - 2014 (Blade)	ADS187
Vauxhall®	Movano B - 2010 (Blade)	ADS180

South America

MAKE	MODEL	SOFTWARE
Mitsubishi®	Pajero - 2008 (Blade)	ADS154
Fiat®	Grand Siena (Blade)	ADS247

USA

MAKE	MODEL	SOFTWARE
Mitsubishi®	Mirage - 2012 (Blade)	ADS189

December 2015 - 19 Vehicles Added

Africa

MAKE	MODEL	SOFTWARE
Toyota®	HI LUX Vigo - 2005 to 2008 (Blade)	ADS125
Ford®	Transit - 2014 (Blade)	ADS150
Opel®	Vivaro - 2002 to 2008 (Blade)	ADS104

Asia

MAKE	MODEL	SOFTWARE
Mitsubishi®	Delica - 2007 to 2015 (Proximity)	ADS154
Mitsubishi®	Delica - 2007 (Blade)	ADS154

© All the brands and product names mentioned in this flyer are registered trademarks exclusive property of authorized manufacturers. Said trademarks or trade names are nominated only for the purposes of information in order to be rapidly identified.

www.silca.biz - www.silca-automotive.com - www.advanced-diagnostics.com



Key Programming New Vehicles Added to Software and IQ

December 2015 - Continued

Australia

MAKE	MODEL	SOFTWARE
Toyota®	Land Cruiser 100 - 2002 (Blade)	ADS125

USA

MAKE	MODEL	SOFTWARE
Ford®	Escape Hybrid - 2008 to 2012 (Blade)	ADS172
Infiniti®	G35 - 2007 to 2008 (Proximity)	ADS159
Saturn®	Aura - 2007 to 2010 (Blade)	ADS139
Saturn®	Outlook - 2007 to 2009 (Blade)	ADS139
Nissan®	Livina Pin=12 - 2006 to 2010 (Blade)	ADS161
Scion®	XB - 2007 to 2010 (Blade)	ADS125

Europe

MAKE	MODEL	SOFTWARE
Chrysler®	Ypsilon - 2011 (Blade)	ADS168/ ADS185
Lexus®	LS460 - 2006 to 2008 (Proximity)	ADS150

South America

MAKE	MODEL	SOFTWARE
Ford®	Ecosport - 2010 to 2015 (Blade)	ADS222
Honda®	Accord - 1998 to 2000 (Blade)	ADS110
Nissan®	Sentra - 2007 to 2012 (Prox. Twist)	ADS159
Nissan®	Rogue - 2008 to 2011 (Prox. Twist)	ADS159
Nissan®	Livina Pin=12 - 2006 to 2010 (Blade)	ADS161

January 2016 - 7 Vehicles Added

Australia

MAKE	MODEL	SOFTWARE
GM® / Holden®	Malibu - 2012 (Proximity)	ADS223
GM® / Holden®	VF Commodore - 2013 (Proximity)	ADS223
Nissan®	X- Trail - 2008 to 2013 (Blade)	ADS159

Asia

MAKE	MODEL	SOFTWARE
Nissan®	Note - 2010 to 2013 (Proximity)	ADS159
Nissan®	Serena Hybrid - 2016 (Proximity)	ADS159

Africa

MAKE	MODEL	SOFTWARE
Isuzu®	KB300 (Blade)	ADS135

Europe

MAKE	MODEL	SOFTWARE
Toyota®	Land Cruiser - 2004 to 2009 (Blade)	ADS125

© All the brands and product names mentioned in this flyer are registered trademarks exclusive property of authorized manufacturers. Said trademarks or trade names are nominated only for the purposes of information in order to be rapidly identified.

www.silca.biz - www.silca-automotive.com - www.advanced-diagnostics.com



Key Programming New Vehicles Added to Software and IQ

February-April 2016 - 33 Vehicles Added

Asia

MAKE	MODEL	SOFTWARE
Buick®	Park Avenue - 2006 (Blade)	ADS139
Buick®	Royaum - 2005 (Blade)	ADS102
Buick®	GL8 - 2010 to 2012 (Proximity)	ADS187
Buick®	Lacrosse - 2005 to 2009 (Blade)	ADS139
Buick®	Lacrosse - 2010 to 2013 (Proximity)	ADS187
Buick®	Lacrosse - 2014 (Proximity)	ADS223
Buick®	Encore - 2014 (Blade)	ADS187
Buick®	Excelle GT - 2009 (Blade)	ADS187
Cadillac®	ATS 2013 (Proximity)	ADS223
Cadillac®	SLS - 2005 to 2012 (Proximity)	ADS187
Chevrolet®	Aveo - 2011 to 2014 (Blade)	ADS187
Chevrolet®	Captiva ALL (Blade)	ADS139
Chevrolet®	Lumina - 2006 to 2011 (Blade)	ADS139
Chevrolet®	Camero - 2012 (Blade)	ADS223
Daewoo®	Epica ALL (Blade)	ADS119
Ford®	Fiesta - 2008 (Blade)	ADS100
Ford®	Focus - 2005 to 2009 (Blade)	ADS100
Mitsubishi®	Outlander - 2005 to 2012 (Proximity)	ADS154
Nissan®	370Z - 2009 (Proximity)	ADS159
Nissan®	Atlas - 2007 (Blade)	ADS159
Nissan®	Fairlady 350Z - 2003 to 2006 (Blade)	ADS112

Asia

MAKE	MODEL	SOFTWARE
Nissan®	Fairlady 350Z - 2007 (Blade)	ADS159
Nissan®	Frontier - up to 2007 (Blade)	ADS112
Nissan®	Sylphy - 2003 to 2009 (Proximity)	ADS159
Nissan®	X-Trail - 2014 (Proximity)	ADS197
Peugeot®	3008 - 2013 to 2015 (Blade)	ADS142
Suzuki®	SX4 - 2007 to 2010 (Blade)	ADS163
Toyota®	Landcruiser - 2009 to 2013 (Prox.)	ADS150
Toyota®	Rav 4 - 2006 to 2011 (Proximity)	ADS150

Europe

MAKE	MODEL	SOFTWARE
Chevrolet®	Aveo - 2011 (Blade)	ADS130
Infiniti®	FX30d - 2010 (Proximity Slot)	ADS159

Israel

MAKE	MODEL	SOFTWARE
Cadillac®	SRX - 2010 to 2013 (Proximity)	ADS187
Chevrolet®	TRAX - 2009 (Blade)	ADS187

© All the brands and product names mentioned in this flyer are registered trademarks exclusive property of authorized manufacturers. Said trademarks or trade names are nominated only for the purposes of information in order to be rapidly identified.

www.silca.biz - www.silca-automotive.com - www.advanced-diagnostics.com



SILCA NEWS 08/16

ALL THE NEW KEYS, AUTOMOTIVE SOLUTIONS, KEY CUTTING MACHINES, SOFTWARE UPDATES AND MUCH MORE

Contents

New Keys	1
ID48: 4x the Cloning Power	2
Futura Program Update	3





New Keys / Chiavi Nuove / Neue Schlüssel / Nouvelles Clés / Llaves Nuevas / Chaves Nuevas

FOR: PER:	FAB	GUARDIAN		KTM	FOR / PER
	<p>02</p> <p>Delivery time SEPTEMBER 2016</p> <p>FB105R</p>	<p>25</p> <p>Delivery time OCTOBER 2016</p> <p>5GUN1</p>	<p>25</p> <p>Delivery time OCTOBER 2016</p> <p>5GUN3</p>	<p>10</p> <p>Delivery time OCTOBER 2016</p> <p>..... 00001-03001</p> <p>KTM1P</p>	FAB (CZ) GUARDIAN (RU) KTM (AT) KYMCO (KR) LOWE & F. (GB) MERONI (IT)
	<p>10</p> <p>Delivery time OCTOBER 2016</p> <p>..... 1001-1910</p> <p>KTM2RP</p>	<p>10</p> <p>Delivery time AUGUST 2016</p> <p>KYM3AP KYM3RAP</p>	<p>04</p> <p>Delivery time OCTOBER 2016</p> <p>LF62</p>	<p>02</p> <p>Delivery time SEPTEMBER 2016</p> <p>MER42R</p>	<p>01</p> <p>COMMERCIAL GROUP GRUPPO COMMERCIALE PREISEGRUPPE GROUPE COMMERCIAL GRUPO COMMERCIAL GRUPO COMMERCIAL</p> <p>www.silca.biz</p>

ALL THE KEYS DISPLAYED ARE AVAILABLE ALSO IN THE SILCA "NEW KEY COLLECTION"



> Increased cloning capability <



> Higher performance rates <

NOW WITH 4X THE CLONING POWER!



SILCA ID48 SOLUTION

-  Silca ID48 Solution: now with 4 times the cloning power!
-  Soluzione Silca ID48: da oggi ben 4 volte più potente!
-  Lösung Silca ID48: jetzt 4-fache Leistung!
-  Solution Silca ID48: aujourd'hui 4 fois plus puissante!
-  Solución Silca ID48: hoy 4 veces más potente!
-  Solução Silca ID48: agora 4 vezes mais poderosa!

> More info on all Silca websites



SILCA FUTURA PROGRAM

Data Update with new systems

Software Vers. 2.19.0 - db 3.05
App Vers. 1.21



Futura

Data update with new systems / Aggiornamento dati con nuovi sistemi / Datenaktualisierung mit neuen Systemen / Mise à jour des données avec nouveaux systèmes / Actualización de datos con sistemas nuevos / Atualização de dados com novos sistemas

New items include / Tra le novità / Unter den Neuheiten / Parmi les nouveautés / Entre las novedades / Entre as novidades:

- Abus® 83
- Abus® U72
- Abus® U74
- Esety® Omega
- Euro Locks® EU21P (2T-7/8W)
- Federal® UCF3100
- Kia® (2T- 8W)
- Kia® (2T- 8W)
- Pfaffenhain® S5+
- Ronis®
- Titan® 16 (6P)
- Tonyon® TY340-STZ52-STB24-KB23 (4T-5W)
- Trelock® InX M2 (4T-4W)
- Trelock® InX ML2 (4T-4W)
- Witte® - Volvo® XC90 (2T - 8W)
- Yardeni® 6 Master-No cut tip
- Yardeni® 6 Regular-Cut tip
- Yardeni® 6 Master-Cut tip

🇬🇧 Remember to update the Silca.apk and SilcaKeyboard.apk after installing the Software update (see the on board Instructions Manual - Ch. 7.3 APP UPDATE (apk)).

🇫🇷 N'oubliez pas de mettre à jour Silca.apk et SilcaKeyboard.apk après avoir installé la mise à jour du logiciel (voir le Manuel d'instructions - Ch.7.3 MISE A JOUR APP (apk)).

🇮🇹 Ricordarsi di aggiornare Silca.apk e SilcaKeyboard.apk dopo l'installazione dell'aggiornamento (vedi le istruzioni nel Manuale d'uso - Cap. 7.3 AGGIORNAMENTO APP (apk)).

🇪🇸 No olvidar actualizar Silca.apk y SilcaKeyboard.apk después de instalar la versión actualizada del programa (ver indicaciones a bordo máquina integradas en el Manual - Ch 7.3 ACTUALIZACIÓN APP (apk)).

🇩🇪 Behebt Probleme, die beim Software-Update der Maschine über das Tablet entstehen können. Für mehr Details lesen Sie die Bedienungsanleitung (Kap. 7.3 AKTUALISIERUNG APP (apk)).

🇵🇹 Lembrar de atualizar o Silca.apk eo SilcaKeyboard.apk após a instalação da atualização (ver as instruções no Manual de Utilização - Capítulo 7.3 ATUALIZAÇÃO APP (apk)).



SILCA NEWS 09/16

ALL THE NEW KEYS, AUTOMOTIVE SOLUTIONS, KEY CUTTING MACHINES, SOFTWARE UPDATES AND MUCH MORE

Contents

New Keys	1
Vehicle Keys Guide	2
Silca Air4 Visor Clip	3
Security Essen 2016	4
SKP Web Update	5



Silca Air4 Visor Clip



Security Essen 2016

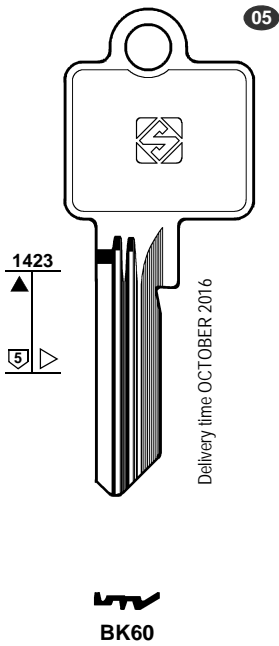
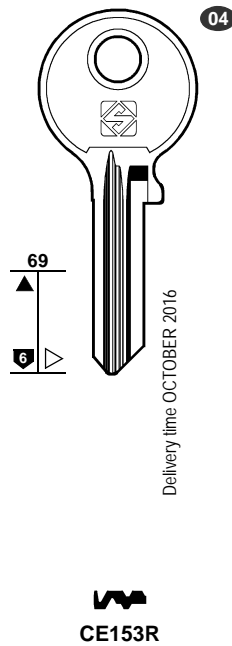
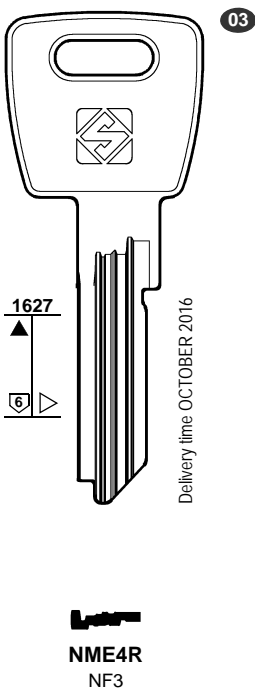

New Keys / Chiavi Nuove / Neue Schlüssel / Nouvelles Clés / Llaves Nuevas / Chaves Nuevas

FOR: PER:	BKS	CES	FOR / PER
	<div data-bbox="215 465 494 1108" data-label="Image">  <p>05</p> <p>1423</p> <p>5</p> <p>Delivery time OCTOBER 2016</p> <p>BK60</p> </div>	<div data-bbox="861 465 1093 1108" data-label="Image">  <p>04</p> <p>69</p> <p>6</p> <p>Delivery time OCTOBER 2016</p> <p>CE153R</p> </div>	BKS (DE)
			CES (DE)
			NEMEF (NL)
	<div data-bbox="555 1361 810 2049" data-label="Image">  <p>03</p> <p>1627</p> <p>5</p> <p>Delivery time OCTOBER 2016</p> <p>NME4R NF3</p> </div>		
	NEMEF		
			<div data-bbox="1294 1937 1468 2078" data-label="Text"> <p>01 COMMERCIAL GROUP GRUPPO COMMERCIALE PREISEGRUPPE GROUPE COMMERCIAL GRUPO COMMERCIAL GRUPO COMERCIAL</p> </div> <div data-bbox="1321 2083 1508 2116" data-label="Text"> <p>www.silca.biz</p> </div>

Motorcycle Keys Guide / Guida Chiavi Moto / Marktführer für Motorräderschlüssel
 Guide Clés pour Motocyclettes / Guía Llaves para Motocicletas / Guia Chaves para Motocicletas

New Updates

1	2	2a	3	3a	3b	E3 / E4 / E2			6	42+71	72	43 44a	12
						TRANSPONDER INFO				IGNITION			
CAR MAKE MODEL	FROM	TO	SILCA REF.	SILCA REF.	SILCA REF.	TRANSP. COPY	TRANSP. PROGR.	GEN. ON GTI	TRANSP. TYPE	FAST COPY PLUS RW4 PLUS FAST COPY / RW4	FAST COPY PLUS RW4 PLUS	FAST COPY RW4 + P-BOX/M-BOX	STP

For more info on the uses of car keys, refer to the Silca Electronic Key Catalogue:



KTM®													
RC 125	2015		KTM1P										
RC 200	2014		KTM1P										
RC 390	2015		KTM1P										
125 DUKE	2012		KTM1P										
200 DUKE	2015		KTM1P										
390 DUKE	2014		KTM1P										
690 DUKE	2008	2010	KTM2RP										
690 ENDURO	2008	2012	KTM2RP										
690 SMC	2009	2010	KTM2RP										
690 SUPER ENDURO	2008		KTM2RP										
690 SUPERMOTO	2008		KTM2RP										
950 SMR	2008		KTM2RP										
950 SUPERMOTO	2008		KTM2RP										
990 ADVENTURE	2009	2012	KTM2RP										
990 RC8R SUPER DUKE	2011		KTM2RP										
KYMCO®													
DINK	2006	2007	KYM3AP										
DINK	2006	2007	KYM3RAP										
FILLY	2001	2002	KYM3AP										
FILLY	2001	2002	KYM3RAP										
GRANDINK	2003	2012	KYM3AP										
GRANDINK	2003	2012	KYM3RAP										
MOVIE	2003	2004	KYM3AP										
MOVIE	2003	2004	KYM3RAP										
PEOPLE	2003	2008	KYM3AP										
PEOPLE	2003	2008	KYM3RAP										

See also the "Vehicle Guide Legend" / Vedi anche la "Legenda Guida Veicoli" / Siehe auch die "Fahrzeugschlüssel Erläuterung" / Voir aussi la "Légende Guide Véhicules" / Véase también la "Leyenda Guía para Vehículos" / Veja também a "Legenda Guia para Veículos"

The uses of the keys are purely indicative and may be subject to updates and revisions. / Gli utilizzi delle chiavi sono da considerarsi puramente indicativi e possono essere oggetto di aggiornamenti e revisioni. / Die Abbildung und technischen Daten der Schlüssel sind nicht bindend. Silca behält sich Änderungen am Produkt, die zur Verbesserung beitragen, vor. / Les usages des clés sont purement indicatifs; ils peuvent être mis à jour et revus. / Los usos de las llaves deben considerarse puramente indicativos y pueden ser objeto de actualizaciones y revisiones. / As utilizações das chaves devem ser consideradas puramente indicativas e podem ser objecto de actualizações e revisões.

© Registered Trademarks. / © Marchi Registrati. / © Eingetragene Marken. / © Marques Déposées. / © Marcas Registradas. / © Marcas Registradas.



Silca Air4 Visor Clip



🇬🇧 SILCA VISOR CLIP

Designed specifically for use in the car and unique to Silca, the Visor Clip is the perfect partner for the Air4 residential remotes.

No more searching around the glove box, once it's fixed to the sun visor you know the remote is always to hand.

At an attractive price why not offer it to every customer buying a Silca Air4 remote?

Available in white.
Code: **AVZ1106**

🇮🇹 SILCA VISOR CLIP

Visor Clip è un accessorio da applicare al tuo radiocomando Air4 ed è stato appositamente studiato per essere utilizzato nella tua auto.

Una volta fissato al parasole ti consente di averlo sempre a portata di mano senza creare ingombro nel tuo portachiavi.

Perché non proporlo ai clienti che acquistano un radiocomando Air4? Il prezzo è interessante!

Disponibile in bianco.
Codice: **AVZ1106**

🇩🇪 SILCA VISOR CLIP

Entwickelt für die Nutzung insbesondere im Fahrzeug ist der Silca Visor Clip der perfekte Partner für die Air4 Fernbedienung.

Kein Suchen mehr im Handschuhfach, einmal an der Sonnenblende befestigt, ist die Fernbedienung stets griffbereit.

Dank des attraktiven Preises macht es Sinn, diesen Clip jedem Kunden anzubieten, der eine Silca Air4 Fernbedienung kauft.

Verfügbar in Weiß.
Code: **AVZ1106**

🇵🇹 SILCA VISOR CLIP

Conçu spécifiquement pour être utilisée en voiture, la fixation pare soleil est le produit complémentaire idéal de la télécommande Air4 habitat.

Plus besoin de chercher dans la boîte à gants, une fois fixée au pare soleil, votre télécommande est toujours à portée de main.

A un prix attractif, pourquoi ne pas la proposer à tous les clients qui vous achètent une télécommande Air4?

Disponibile in bianco.
Code: **AVZ1106**

🇪🇸 SILCA VISOR CLIP

Exclusivo de Silca y diseñado específicamente para uso en su vehículo, el Visor Clip es el compañero perfecto para el mando a distancia Air4.

Se acabó el rebuscar en la guantera, una vez que se ha fijado al parasol sabes que el mando a distancia está siempre a mano.

A tan atractivo precio, porque no proponer la compra del control remoto Silca Air4 a todos los clientes!

Disponibile in bianco.
Código: **AVZ1106**

🇧🇷 SILCA CLIP PARA QUEBRA SOL

Desenhado especificamente para aplicação veicular e exclusivamente para a Silca, o Clip para quebra sol é o complemento ideal para o controle remoto Air4 da Silca.

Uma volta fissato al parasole ti consente di averlo sempre a portata di mano senza creare ingombro nel tuo portachiavi.

Por um preço atrativo, por que não oferecê-lo a todos os clientes que comprarem o controle remoto Silca Air4!

Disponibile in bianco.
Código: **AVZ1106**



Current news Exhibitor List security innovation award Industry news



Enter the World of Security

World's leading fair for security and fire prevention



Security Essen 27.09 -30.09.2016

The world's leading fair for security and fire prevention



 Silca is attending the Security Essen, taking place in Essen (Germany), from 27th to 30th September 2016.

Come visit us at Booth 12B04, Hall 12.

 Silca wird an der Security Essen, die vom 27. bis 30. September 2016 in Essen (Deutschland) veranstaltet wird, teilnehmen.

Besuchen Sie uns am Stand 12B04, Halle 12.

 Silca asistirá a Security Essen, que tendrá lugar en Essen (Alemania), del 27 al 30 de Septiembre de 2016.

Venga a visitarnos en el Stand 12B04, Pabellón 12.

 Silca parteciperà a Security Essen, che si terrà ad Essen (Germania), dal 27 al 30 Settembre 2016.

Vieni a visitarci allo Stand 12B04, Padiglione 12.

 Silca participera à Security Essen, qui se tiendra à Essen (Allemagne), du 27 au 30 septembre 2016.

Venez nous visiter au Stand 12B04, Pavillon 12.

 Silca participará do Security Essen, que será realizada em Essen (Alemanha), de 27 a 30 Setembro 2016.

Venha visitar-nos no Estande 12B04, Pavilhão 12.



Visit us at:

Hall 12

Booth 12B04



> Save the date



Silca Key Programs - WEB Update

SKP - WEB UPDATE

A new update of the SILCA KEY PROGRAMS software is available to all WEB subscribers.

Check out the "News" section of Silca Key Programs on www.silca.biz to know more.

SKP - AGGIORNAMENTO WEB

È disponibile un nuovo aggiornamento del software SILCA KEY PROGRAMS per tutti gli abbonati WEB.

Consulta la sezione "Novità" di Silca Key Programs sul sito www.silca.biz per saperne di più.

SKP - AKTUALISIERUNG WEB

Für alle WEB Abonnenten ist eine neue Aktualisierung von der Software SILCA KEY PROGRAMS verfügbar.

Im Bereich "Neuheiten" auf der Internetseite www.silca.biz finden Sie weitere Informationen.

SKP - MISE À JOUR WEB

Une nouvelle mise à jour du logiciel SILCA KEY PROGRAMS pour tous les abonnements WEB est disponible.

Consultez la section "Nouveautés" de Silca Key Programs sur notre site www.silca.biz pour en savoir plus.

SKP - ACTUALIZACIÓN WEB

Una nueva actualización del software SILCA KEY PROGRAMS para todos los abonados WEB está disponible.

Visite la sección "Novedades" de Silca Key Programs en el sitio www.silca.biz para más informaciones.

SKP - ATUALIZAÇÃO WEB

Nova atualização do software SILCA KEY PROGRAMS para todos o assinantes WEB está disponível.

Consulte a seção "Novidades" de Silca Key Programs no site www.silca.biz para saber mais.

Info on all Silca websites

Home > Products > Silca Key Programs > News

Silca Key Programs News



The News section gives information introduced into the Silca Key Programs program.

The customers who subscribe to Silca Key Programs will receive three or four updates between January and December.

To consult or download on your personal computer the documents attached, click on the following links:

SKP Updates 2015/2016

- [SKP WEB Update - September 2016 \(PDF\)](#)
- [SKP Update 2/2016 \(PDF\)](#)

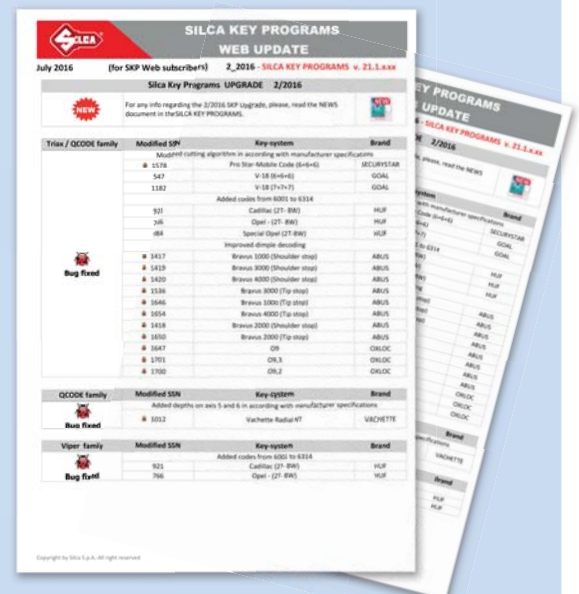



SILCA NEWS 10/16

ALL THE NEW KEYS, AUTOMOTIVE SOLUTIONS, KEY CUTTING MACHINES, SOFTWARE UPDATES AND MUCH MORE

Contents

New Keys	1
Vehicle Keys Guide	2
Latest Catalogues Recap	3-4
Silca @ Essen 2016	5
Futura and SKP Web Update	6
ADS255 Subaru Software	7-8
Key Cutting Machine Accessories	9





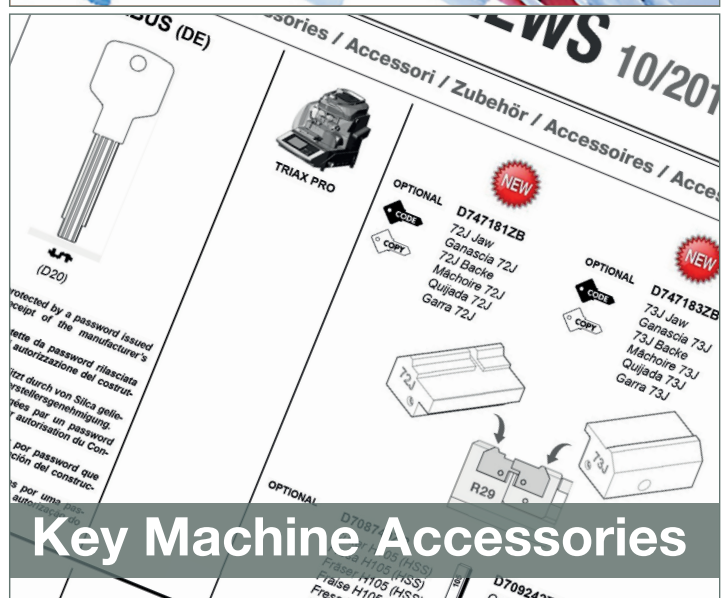

Latest Catalogues Recap



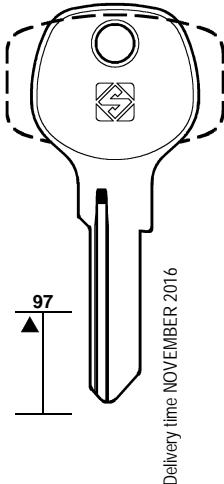
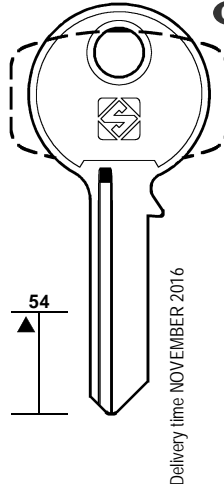
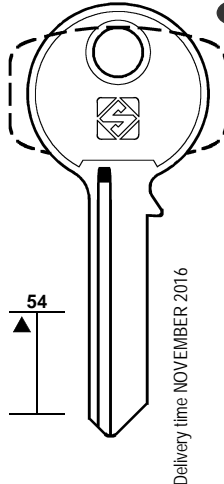

Key Machine Accessories

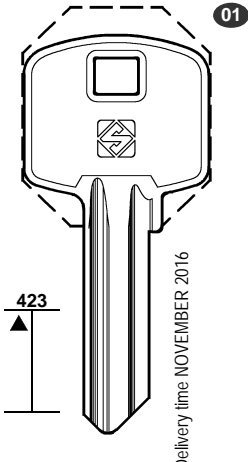

New Keys / Chiavi Nuove / Neue Schlüssel / Nouvelles Clés / Llaves Nuevas / Chaves Nuevas

FOR: PER:	BULAT		
			
	 BUT2R	 BUT3R	 BUT4R

FOR: PER:	FUARO
	
	 FU1

















FOR / PER
BULAT (CN)
FUARO (RU)

01
 COMMERCIAL GROUP
 GRUPPO COMMERCIALE
 PREISEGRUPPE
 GROUPE COMMERCIAL
 GRUPO COMMERCIAL
 GRUPO COMERCIAL

www.silca.biz

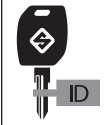
Car Keys Guide / Guida Chiavi Auto / Marktführer für Autoschlüssel / Guide Clés pour Voitures
 Guía Llaves para Coches / Guia Chaves para Carros

New Updates

1	2	2a	3	3a	3b	E3 / E4 / E2			6	42+71	72	43 44a	12
						TRANSPONDER INFO				IGNITION			
													
CAR MAKE MODEL	FROM	TO	SILCA REF.	SILCA REF.	SILCA REF.	TRANSP. COPY	TRANSP. PROGR.	GEN. ON GTI	TRANSP. TYPE	FAST COPY PLUS RW4 PLUS FAST COPY / RW4	FAST COPY PLUS RW4 PLUS	FAST COPY RW4 + P-BOX/M-BOX	STP
													

For more info on the uses of car keys, refer to the Silca Electronic Key Catalogue:



HONDA® USA

ACCORD	2013				HON66FH				PH / CR3	49-1C			
CIVIC	2014		SMART KEY						PH / CR3	49-1C			
CROSSTOUR	2013								PH / CR3	49-1C			
CROSSTOUR	2013		SMART KEY						PH / CR3	49-1C			
CR-V	2014				HON66FH				PH / CR3	49-1C			
FIT	2015		SMART KEY						PH / CR3	49-1C			
FIT	2015				HON66FH				PH / CR3	49-1C			
HR-V	2016		SMART KEY						PH / CR3	49-1C			
HR-V	2016				HON66FH				PH / CR3	49-1C			

HYUNDAI®

SANTA FE (US)	2013		SMART KEY						PH / CR2	46			
---------------	------	--	-----------	--	--	--	--	--	----------	----	--	--	--

KIA®

SORENTO (USA)	2011		SMART KEY						PH / CR2	46			
---------------	------	--	-----------	--	--	--	--	--	----------	----	--	--	--

See also the "Vehicle Guide Legend" / Vedi anche la "Legenda Guida Veicoli" / Siehe auch die "Fahrzeugschlüssel Erläuterung" / Voir aussi la "Légende Guide Véhicules" / Véase también la "Leyenda Guía para Vehículos" / Veja também a "Legenda Guia para Veículos"

The uses of the keys are purely indicative and may be subject to updates and revisions. / Gli utilizzi delle chiavi sono da considerarsi puramente indicativi e possono essere oggetto di aggiornamenti e revisioni. / Die Abbildung und technischen Daten der Schlüssel sind nicht bindend. Silca behält sich Änderungen am Produkt, die zur Verbesserung beitragen, vor. / Les usages des clés sont purement indicatifs; ils peuvent être mis à jour et revus. / Los usos de las llaves deben considerarse puramente indicativos y pueden ser objeto de actualizaciones y revisiones. / As utilizações das chaves devem ser consideradas puramente indicativas e podem ser objecto de actualizações e revisões.

© Registered Trademarks. / © Marchi Registrati. / © Eingetragene Marken. / © Marques Déposées. / © Marcas Registradas. / © Marcas Registradas.



The picture shown is for illustration purposes only

Remember to order the latest Silca catalogues.

108 Catalogue Update



Order Code: P918

🇬🇧 108 Catalogue Update

The Catalogue 108 Update completes and updates the range of flat keys for cylinder locks, cruciform keys, lift and mailbox keys presented in the 108 Catalogue.

🇮🇹 108 Catalogue Update

Il Catalogo 108 Update completa e aggiorna la gamma di chiavi piatte per serrature a cilindro, chiavi a croce, per ascensori e casellari postali già presente nel Catalogo 108.

🇩🇪 108 Catalogue Update

Das Katalog 108 Update vervollständigt und aktualisiert das Sortiment der Flachschlüssel für Zylinderschlösser, der Kreuzbartschlüssel, der Fachkasten- und Liftschlüssel des Katalogs 108.

🇫🇷 108 Catalogue Update

Notre Catalogue 108 Update complète et met à jour la gamme de clés plates pour serrures à cylindre, clés croix, pour ascenseurs et boîtes aux lettres répertoriée dans notre Catalogue 108.

🇪🇸 108 Catalogue Update

El Catálogo 108 Update completa y actualiza la gama de llaves planas para cerraduras de cilindro, llaves en cruz, para ascensores y casilleros postales, contenida en el Catálogo 108.

🇵🇹 108 Catalogue Update

O Catálogo 108 Update completa e actualiza a gama de chaves planas para fechaduras de cilindro, chaves tetra, para elevadores e caixas de correio já presente no Catálogo 108.



Key Cutting Machine Catalogues



Order electronic and mechanical catalogues

KEY MACHINE CATALOGUES

Catalogues of mechanical and electronic key cutting machines, cloning and programming devices for vehicle keys, reading and marking devices.

Mechanical key machines: **POBP-5**
Electronic machines and devices: **POBV-5**

CATALOGHI DUPLICATRICI

Cataloghi relativi alla gamma di duplicatrici meccaniche ed elettroniche, dispositivi di clonazione e programmazione chiavi veicolo, dispositivi di lettura e incisione.

Macchine meccaniche: **POBQ-5**
Macchine elettroniche e dispositivi: **POBW-5**

SCHLÜSSELMASCHINENKATALOGE

Kataloge von mechanischen und elektronischen Schlüsselräsmaschinen, Kopier- und Programmiergeräte für Fahrzeugschlüssel, Lese- und Gravurmaschinen.

Mechanische Maschinen: **POBL-5**
Elektronische Maschinen und Geräte: **POBS-5**

CATALOGUES MACHINES

Catalogues des machines à tailler les clés mécaniques et électroniques, des dispositifs de clonage et de programmation de clés de véhicules, des dispositifs de lecture et gravure. Machines électroniques et dispositifs: **POBU-5**
Machines mécaniques: **POBN-5**

CATÁLOGOS DUPLICADORAS

Catálogos de las máquinas duplicadoras mecánicas y electrónicas, de los dispositivos de clonación y programación de llaves de vehículo, de los dispositivos de lectura y grabado. Máquinas electrónicas y dispositivos: **POBT-5**
Máquinas mecánicas: **POBM-5**

CATÁLOGOS DUPLICADORAS

Catálogos de duplicadoras mecánicas e eletrónicas, de dispositivos de clonagem e de programação de chaves do veículo, de dispositivos de leitura e incisão. Máquinas eletrônicas e dispositivos: **POBX-5**
Máquinas mecánicas: **POBR-5**

Air4 Remote Catalogue



Order Code: P0QM-1

AIR4 CATALOGUE - VERS. 1

Silca has developed a catalogue to support your residential remote duplication business, presenting the range of Air4 remotes and the Easy Scan device for duplicating them.

CATALOGO AIR4 - VERS. 1

Silca ha sviluppato un catalogo a supporto del tuo servizio duplicazione radiocomandi residenziali, che presenta la gamma di radiocomandi Air4 e il dispositivo Easy Scan, utilizzato per la loro duplicazione.

AIR4 KATALOG - VERS. 1

Silca hat einen Katalog entwickelt, um Ihren Service von Funkfernbedienungen im Wohnbereich zu unterstützen. Der Katalog präsentiert die Funkfernbedienungen Air4 und das Gerät Easy Scan, das Sie durch das Kopierverfahren der Air4 führt.

CATÁLOGO AIR4 - VERS. 1

Silca desenvolveu um catálogo para apoiar o seu serviço de duplicação de rádio controles residenciais, que apresenta a gama de Air4 eo dispositivo Easy Scan, usado para duplicá-los.

CATALOGUE AIR4 - VERS. 1

Silca a développé un catalogue pour soutenir votre service de reproduction de télécommandes à usage domestique, qui présente la gamme de Air4 et le dispositif Easy Scan, utilisé pour leur duplication.

CATÁLOGO AIR4 - VERS. 1

Silca ha desarrollado un catálogo en apoyo de su servicio de duplicación de mandos a distancia residenciales, que presenta la gama de mandos Air4 y el dispositivo Easy Scan, utilizado para duplicarlos.

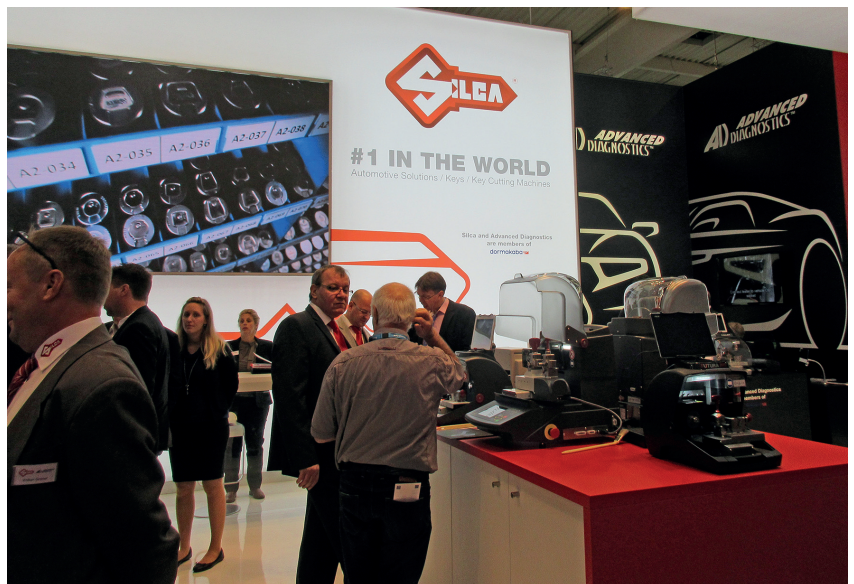



Silca Key Programs - WEB Update

SKP - WEB UPDATE

A new update of the SILCA KEY PROGRAMS software is available to all WEB subscribers.

Check out the "News" section of Silca Key Programs on www.silca.biz to know more.

SKP - MISE À JOUR WEB

Une nouvelle mise à jour du logiciel SILCA KEY PROGRAMS pour tous les abonnements WEB est disponible.

Consultez la section "Nouveautés" de Silca Key Programs sur notre site www.silca.biz pour en savoir plus.

SKP - AGGIORNAMENTO WEB

È disponibile un nuovo aggiornamento del software SILCA KEY PROGRAMS per tutti gli abbonati WEB.

Consulta la sezione "Novità" di Silca Key Programs sul sito www.silca.biz per saperne di più.

SKP - ACTUALIZACIÓN WEB

Una nueva actualización del software SILCA KEY PROGRAMS para todos los abonados WEB está disponible.

Visite la sección "Novedades" de Silca Key Programs en el sitio www.silca.biz para más informaciones.

SKP - AKTUALISIERUNG WEB

Für alle WEB Abonnenten ist eine neue Aktualisierung von der Software SILCA KEY PROGRAMS verfügbar.

Im Bereich "Neuheiten" auf der Internetseite www.silca.biz finden Sie weitere Informationen.

SKP - ATUALIZAÇÃO WEB

Nova atualização do software SILCA KEY PROGRAMS para todos o assinantes WEB está disponível.

Consulte a seção "Novidades" de Silca Key Programs no site www.silca.biz para saber mais.

SILCA FUTURA PROGRAM

Data Update with new systems

Software Vers. 2.20.0 - db 3.06

App Vers. 1.21



Futura

Data update with new systems / Aggiornamento dati con nuovi sistemi / Datenaktualisierung mit neuen Systemen / Mise à jour des données avec nouveaux systèmes / Actualización de datos con sistemas nuevos / Atualização de dados com novos sistemas

New items include / Tra le novità / Unter den Neuheiten / Parmi les nouveautés / Entre las novedades / Entre as novidades:

- Abus®
- Abus® 83
- Kaba® ExperT S 1.2b (K56B)
- Kaba® ExperT S 1.2a (K56A)
- Kaba® ExperT pluS S 1.0a (K83A)
- Kaba® ExperT pluS S 1.0b (K83B)
- M&T® Champions Pro CP4 (C6LJ2)
- M&T® Champions Pro CP4 (C6LJK)

New Software Release for Subaru® vehicles ADS255 - Code D747856AD

October 2016



 Advanced Diagnostics are pleased to announce the release of Subaru® 2016 ADS255 software. **The new software programs keys for various Subaru® vehicles worldwide without requiring a pincode when at least one working key is available.**

 Advanced Diagnostics ha sviluppato il software ADS255 Subaru® 2016 dedicato alla **programmazione di chiavi veicolo utilizzate su numerosi modelli Subaru® diffusi in tutto il mondo. Il software non richiede l'utilizzo di codici pin, ma deve essere disponibile almeno una chiave funzionante.**

 Advanced Diagnostics hat die neue Software ADS255 Subaru® 2016 **zum Programmieren von Fahrzeugschlüsseln der weltweit verbreiteten Subaru®-Modelle entwickelt. Diese Software erfordert keine Eingabe von Pin-Codes, aber Sie sollten mindestens einen funktionierenden Schlüssel haben.**

 Advanced Diagnostics a développé le logiciel ADS255 Subaru® 2016 dédié à la **programmation de clés de véhicule utilisées sur de nombreux modèles Subaru® répandus dans le monde. Ce logiciel n'exige aucun code PIN, mais on doit disposer d'au moins une clé en ordre de marche.**



 Advanced Diagnostics se complace en anunciarles el lanzamiento del software ADS255 Subaru® 2016. **Este nuevo software programa llaves en varios modelos de Subaru® sin necesidad de código pin - siempre que el vehículo disponga de una llave arrancando.**

 A Advanced Diagnostics desenvolveu o software ADS255 Subaru® 2016 dedicado à **programação de chaves para veículo utilizadas em muitos modelos Subaru® difundidos por todo o mundo quando estiver disponível pelo menos uma chave que funcione. O software não necessita de códigos PIN.**

DETAILS OFFER

Cable	ADC250 or ADC251
Dongle	A or Smart Dongle
Software category	C
Other software required	ADS228
Smart card	Yes - or Smart Dongle

© All the brands and product names mentioned in this flyer are registered trademarks exclusive property of authorized manufacturers. Said trademarks or trade names are nominated only for the purposes of information in order to be rapidly identified.



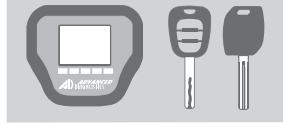

www.silca.biz - www.silca-automotive.com - www.advanced-diagnostics.com



Software Applications

Subaru® ADS255

TABLE

								
Forester (Blade) 2012 to 2016	✓	✓	✗	✗	ADC250 or ADC251	A or Smart Dongle	✓	TOY43TE
Impreza (Proximity) 2013 to 2016	✓	✓	✗	✗	ADC250 or ADC251	A or Smart Dongle	✓	Not available
Levorg (Proximity) up to 2016	✓	✓	✗	✗	ADC250 or ADC251	A or Smart Dongle	✓	Not available
Outback (Blade) 2015 to 2016	✓	✓	✗	✗	ADC250 or ADC251	A or Smart Dongle	✓	DAT17TE
STI (Proximity) 2014 to 2016	✓	✓	✗	✗	ADC250 or ADC251	A or Smart Dongle	✓	Not available
WRX (Proximity) 2014 to 2016	✓	✓	✗	✗	ADC250 or ADC251	A or Smart Dongle	✓	Not available
XV (Proximity) 2014 to 2016	✓	✓	✗	✗	ADC250 or ADC251	A or Smart Dongle	✓	Not available
XV (Blade) 2013 to 2016	✓	✓	✗	✗	ADC250 or ADC251	A or Smart Dongle	✓	TOY43TE

Important Note: To prevent damage to Smart Dongle, ensure that the ignition is turned off when connecting the programmer to the vehicle.
 / **Nota importante:** per prevenire eventuali danni al dispositivo Smart Dongle, assicurarsi che il motore sia spento nel momento in cui il dispositivo di programmazione viene collegato al veicolo. / **Wichtige Information:** Um Beschädigungen am Smart Dongle zu vermeiden, stellen Sie bitte sicher, dass die Zündung ausgeschaltet ist, wenn das Programmiergerät mit dem Fahrzeug verbunden wird. / **Remarque importante:** pour prévenir d'éventuels dégâts sur le dispositif Smart Dongle, assurez-vous que le moteur soit éteint au moment où le dispositif de programmation est connecté au véhicule. / **Nota importante:** para prevenir cualquier daño al Smart Dongle, asegúrese de que el contacto está apagado cuando conecte el dispositivo de programación al vehículo. / **Anotação importante:** para prevenir eventuais danos no dispositivo Smart Dongle, certificar-se de que o motor está desligado no momento em que o dispositivo de programação é ligado ao veículo.

© All the brands and product names mentioned in this flyer are registered trademarks exclusive property of authorized manufacturers. Said trademarks or trade names are nominated only for the purposes of information in order to be rapidly identified.

www.silca.biz - www.silca-automotive.com - www.advanced-diagnostics.com

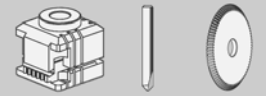
Accessories / Accessori / Zubehör / Accessoires / Accesorios / Acessórios

 FOR:
PER:

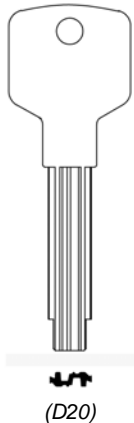
ABUS (DE)

Codes tables protected by a password issued by Silca on receipt of the manufacturer's authorization.

Tabelle codici protette da password rilasciata da Silca a fronte di autorizzazione del costruttore.

Code-Tabellen geschützt durch von Silca geliefertes Password auf Herstellersgenehmigung.

Tables de codes protégées par un password qui est émis par Silca sur autorisation du Constructeur.

Tablas codigos protegidos por password que expide Silca contra autorización del constructor.

Tabelas de códigos protegidas por uma password emitida por Silca contra autorização do fabricante.



TRIAX PRO

OPTIONAL D747181ZB

CODE
COPY
 72J Jaw
 Ganascia 72J
 72J Backe
 Mâchoire 72J
 Quijada 72J
 Garra 72J

OPTIONAL D747183ZB

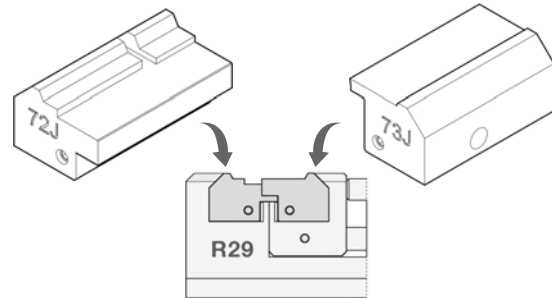
CODE
COPY
 73J Jaw
 Ganascia 73J
 73J Backe
 Mâchoire 73J
 Quijada 73J
 Garra 73J



OPTIONAL D708740ZB

Cutter H105 (HSS)
 Fresa H105 (HSS)
 Fräser H105 (HSS)
 Fraise H105 (HSS)
 Fresa H105 (HSS)
 Fresa H105 (HSS)

D709242ZB

Cutter W105 (carbide)
 Fresa W105 (metallo duro)
 Fräser W105 (Hartmetall)
 Fraise W105 (au carbure)
 Fresa W105 (metal duro)
 Fresa W105 (metal duro)

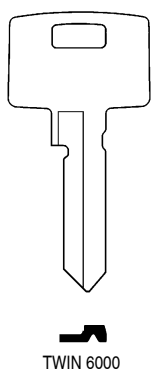
 FOR:
PER:

ASSA (SE)

TRIAX PRO

OPTIONAL D747639ZB

CODE
COPY
 70J Jaw
 Ganascia 70J
 70J Backe
 Mâchoire 70J
 Quijada 70J
 Garra 70J

OPTIONAL D747179ZB

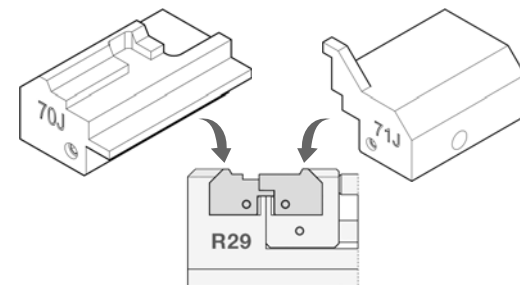
CODE
COPY
 71J Jaw
 Ganascia 71J
 71J Backe
 Mâchoire 71J
 Quijada 71J
 Garra 71J



OPTIONAL D709362ZB

Cutter W202 (carbide)
 Fresa W202 (metallo duro)
 Fräser W202 (Hartmetall)
 Fraise W202 (au carbure)
 Fresa W202 (metal duro)
 Fresa W202 (metal duro)

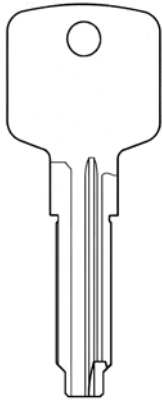

FOR:
PER:

CISA (IT)



Astral Tekno

PROFILES

S34 - S35 - S36 - S37 - S38 - S39
S40 - S41 - S42 - S43 - S44

Codes tables protected by a password issued by Silca on receipt of the manufacturer's authorization.

Tabella codici protette da password rilasciata da Silca a fronte di autorizzazione del costruttore.

Code-Tabellen geschützt durch von Silca geliefertes Passwort auf Herstellersgenehmigung.

Tables de codes protégées par un password qui est émis par Silca sur autorisation du Constructeur.

Tablas códigos protegidos por password que expide Silca contra autorización del constructor.

Tabelas de códigos protegidas por uma password emitida por Silca contra autorização do fabricante.



TRIAX PRO



OPTIONAL **D747185ZB**

 **74J Jaw**
Ganascia 74J
74J Backe
Mâchoire 74J
Quijada 74J
Garra 74J



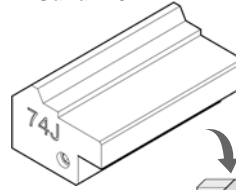

OPTIONAL **D747187ZB**

 **75J Jaw**
Ganascia 75J
75J Backe
Mâchoire 75J
Quijada 75J
Garra 75J



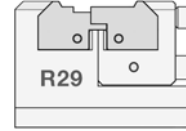
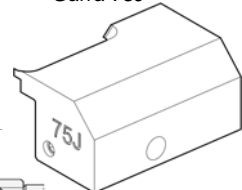

OPTIONAL **D708740ZB**

Cutter H105 (HSS)
Fresa H105 (HSS)
Fräser H105 (HSS)
Fraise H105 (HSS)
Fresa H105 (HSS)
Fresa H105 (HSS)



OPTIONAL **D709242ZB**

Cutter W105 (carbide)
Fresa W105 (metallo duro)
Fräser W105 (Hartmetall)
Fraise W105 (au carbure)
Fresa W105 (metal duro)
Fresa W105 (metal duro)

FOR:
PER:

FIAM (IT)

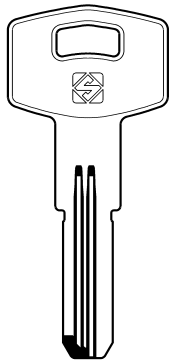



F13R



TRIAX PRO



OPTIONAL **D747169ZB**

 **66J Jaw**
Ganascia 66J
66J Backe
Mâchoire 66J
Quijada 66J
Garra 66J



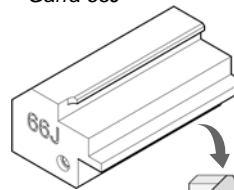

OPTIONAL **D747171ZB**

 **67J Jaw**
Ganascia 67J
67J Backe
Mâchoire 67J
Quijada 67J
Garra 67J



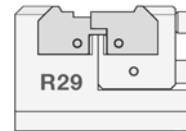
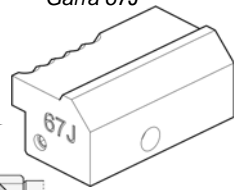

OPTIONAL **D709792ZB**



Cutter W116 (carbide)
Fresa W116 (metallo duro)
Fräser W116 (Hartmetall)
Fraise W116 (au carbure)
Fresa W116 (metal duro)
Fresa W116 (metal duro)

FOR:
PER: **FICHET (FR)**

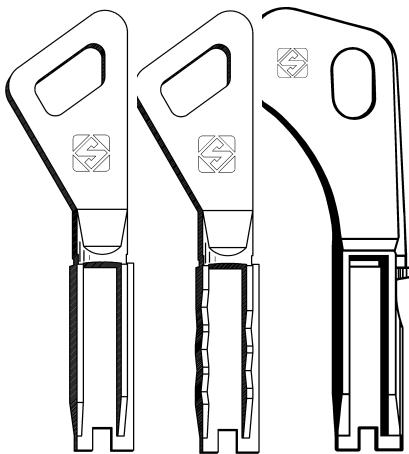

FT500



FT500C



FT510



TRIAX PRO



OPTIONAL **D747165ZB**



64J Jaw
Ganascia 64J
64J Backe
Mâchoire 64J
Quijada 64J
Garra 64J



OPTIONAL **D747167ZB**



65J Jaw
Ganascia 65J
65J Backe
Mâchoire 65J
Quijada 65J
Garra 65J

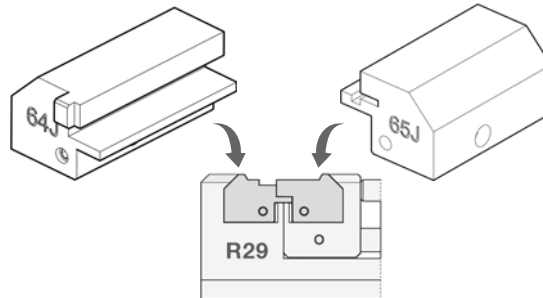

OPTIONAL

D708742ZB

Cutter H101 (HSS)
Fresa H101 (HSS)
Fräser H101 (HSS)
Fraise H101 (HSS)
Fresa H101 (HSS)
Fresa H101 (HSS)



STANDARD

D709238ZB

Cutter W101 (carbide)
Fresa W101 (metallo duro)
Fräser W101 (Hartmetall)
Fraise W101 (au carbure)
Fresa W101 (metal duro)
Fresa W101 (metal duro)

FOR:
PER: **LEHMANN (DE)**

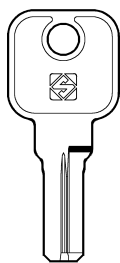

MLM9

(Prestige B5)



TRIAX PRO



OPTIONAL **D747189ZB**



76J Jaw
Ganascia 76J
76J Backe
Mâchoire 76J
Quijada 76J
Garra 76J



OPTIONAL **D747191ZB**



77J Jaw
Ganascia 77J
77J Backe
Mâchoire 77J
Quijada 77J
Garra 77J

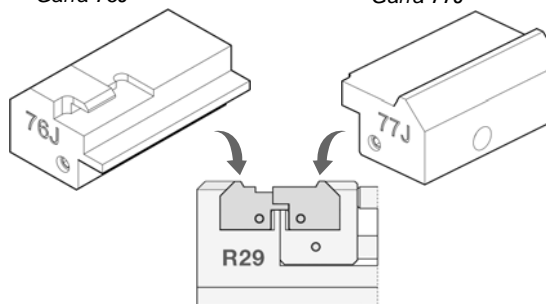

OPTIONAL

D711604ZB

Cutter W129 (carbide)
Fresa W129 (metallo duro)
Fräser W129 (Hartmetall)
Fraise W129 (au carbure)
Fresa W129 (metal duro)
Fresa W129 (metal duro)



FOR:
PER:

MCM (ES)

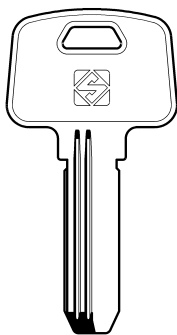

MC10R



TRIAX PRO



OPTIONAL **D747161ZB**



62J Jaw
Ganascia 62J
62J Backe
Mâchoire 62J
Quijada 62J
Garra 62J



OPTIONAL **D747163ZB**



63J Jaw
Ganascia 63J
63J Backe
Mâchoire 63J
Quijada 63J
Garra 63J

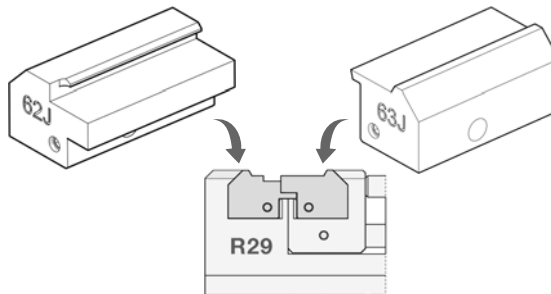

OPTIONAL **D709123ZB**

Cutter H113 (HSS)
Fresa H113 (HSS)
Fräser H113 (HSS)
Fraise H113 (HSS)
Fresa H113 (HSS)
Fresa H113 (HSS)



OPTIONAL **D709250ZB**

Cutter W113 (carbide)
Fresa W113 (metal duro)
Fräser W113 (Hartmetall)
Fraise W113 (au carbure)
Fresa W113 (metal duro)
Fresa W113 (metal duro)

FOR:
PER:

WINKHAUS (DE)

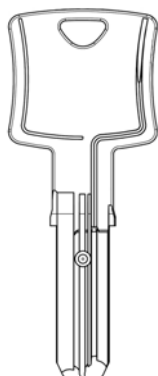

(ON-Tra ON-Tra +)



TRIAX PRO



OPTIONAL **D747193ZB**



78J Jaw
Ganascia 78J
78J Backe
Mâchoire 78J
Quijada 78J
Garra 78J



OPTIONAL **D747195ZB**



79J Jaw
Ganascia 79J
79J Backe
Mâchoire 79J
Quijada 79J
Garra 79J

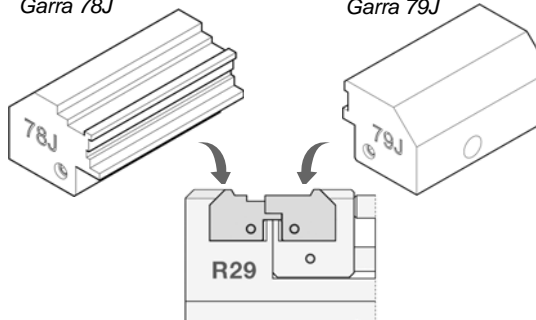

OPTIONAL



D745840ZB

Cutter W332 (carbide)
Fräser W332 (Hartmetall)
Fraise W332 (au carbure)
Fresa W332 (metal duro)
Fresa W332 (metal duro)
Fresa W332 (metal duro)

SYSTEM	CARD	SN
ON-tra (P1)	3938	1613
ON-tra (P3)	3939	1614
ON-tra (EGS)	4060	1667
ON-tra + (P1-P1)	3943	1616
ON-tra + (P1-P2)	3944	1617
ON-tra + (P1-P3)	3945	1618
ON-tra + (P1-P4)	3946	1619
ON-tra + (P1-P5)	3947	1620
ON-tra + (P1-P6)	3948	1621
ON-tra + (P1-P7)	3949	1622
ON-tra + (P1-P8)	3950	1623
ON-tra + (P3-P1)	3951	1624
ON-tra + (P3-P2)	3952	1625
ON-tra + (P3-P3)	3953	1626
ON-tra + (P3-P4)	3954	1627
ON-tra + (P3-P5)	3955	1628
ON-tra + (P3-P6)	3956	1629
ON-tra + (P3-P7)	3957	1630
ON-tra + (P3-P8)	3958	1631

System protected by a password issued by Silca on receipt of authorization.
Sistema protetto da password rilasciata da Silca a fronte di autorizzazione.
Passwort geschütztes System - Freigabe des Herstellers erforderlich.
Système protégé par un password qui est émis par Silca sur autorisation.
Sistema protegido por password que expide Silca contra autorización.
Sistema protegido por uma password emitida por Silca contra a autorização.

FOR:
PER:

WINKHAUS (DE)

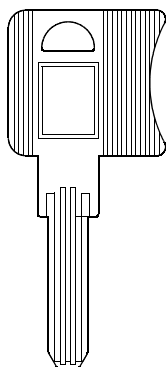

(X-TRA)
(X-TRA Inclined)

System protected by a password issued by Silca on receipt of authorization.

Sistema protetto da password rilasciata da Silca a fronte di autorizzazione.

Passwort geschütztes System - Freigabe des Herstellers erforderlich.

Système protégé par un password qui est émis par Silca sur autorisation.

Sistema protegido por password que expide Silca contra autorización.

Sistema protegido por uma password emitida por Silca contra a autorização.



TRIAX PRO

OPTIONAL



D747201ZB

80J Jaw
Ganascia 80J
80J Backe
Mâchoire 80J
Quijada 80J
Garra 80J



OPTIONAL



D747203ZB

81J Jaw
Ganascia 81J
81J Backe
Mâchoire 81J
Quijada 81J
Garra 81J

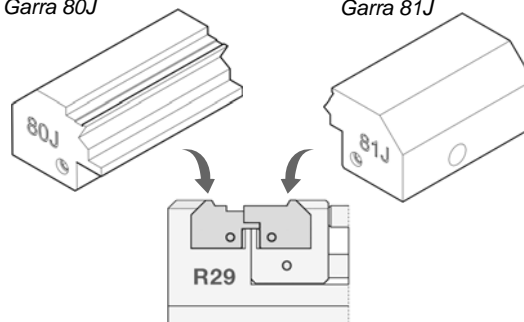

OPTIONAL



D717065ZB

Cutter W255 (carbide)
Fresa W255 (metallo duro)
Fräser W255 (Hartmetall)
Fraise W255 (au carbure)
Fresa W255 (metal duro)
Fresa W255 (metal duro)



SILCA NEWS 11/16

ALL THE NEW KEYS, AUTOMOTIVE SOLUTIONS, KEY CUTTING MACHINES, SOFTWARE UPDATES AND MUCH MORE

Contents

New Keys	1-4
Vehicle Keys Guide	5
Futura Pro	6-7
Futura and SKP Web Update	8
ADS258 Fiat® Software	9-10
ADS257 Ford® Software	11-12





New Keys / Chiavi Nuove / Neue Schlüssel / Nouvelles Clés / Llaves Nuevas / Chaves Nuevas

FOR: PER:		APEKS		BAODEAN		FOR / PER	
						APEKS (RU)	
		1715	1346	1603	1603	BAODEAN (CN)	
		Delivery time NOVEMBER 2016	Delivery time NOVEMBER 2016	Delivery time NOVEMBER 2016	Delivery time NOVEMBER 2016	CINA (CN)	
		APK4	APK5R	BAE2R	BAE3		
FOR: PER:		CINA					
		1603	1684	368	368		
		Delivery time NOVEMBER 2016	Delivery time NOVEMBER 2016	Delivery time DICEMBER 2016	Delivery time DICEMBER 2016		
		RC14R	RC15R	XRC1	XRC2		
						<p>01</p> <p>COMMERCIAL GROUP GRUPPO COMMERCIALE PREISEGRUPPE GROUPE COMMERCIAL GRUPO COMMERCIAL GRUPO COMERCIAL</p> <p>www.silca.biz</p>	

ALL THE KEYS DISPLAYED ARE AVAILABLE ALSO IN THE SILCA "NEW KEY COLLECTION"







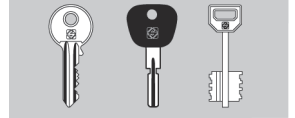



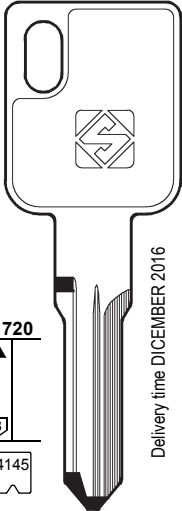

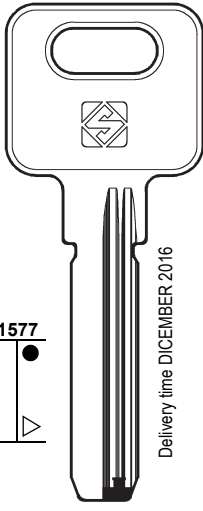
SILCA NEWS 11/2016

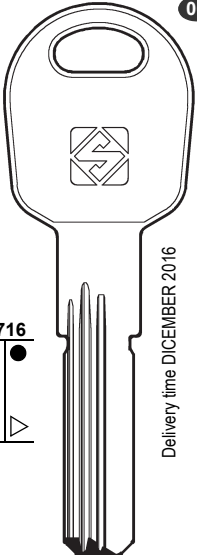
NEW KEYS

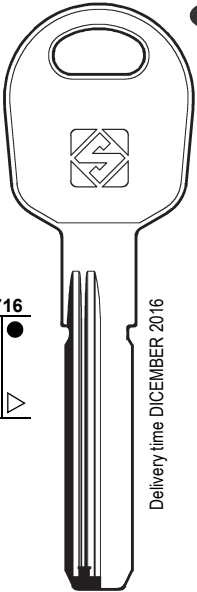

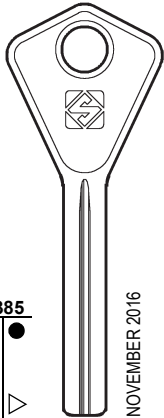
New Keys / Chiavi Nuove / Neue Schlüssel / Nouvelles Clés / Llaves Nuevas / Chaves Nuevas

FOR / PER HUF (DE) KAIXI (CN) MASTER LOCK (TW) SOLEX (FR)	FOR: HUF PER:	FOR: KAIXI PER:	FOR: MASTER LOCK PER:
	 <p>09</p> <p>1720</p> <p>8</p> <p>4145</p> <p>..... 1-2-3-4</p> <p>Delivery time DICEMBER 2016</p> <p>HU136</p> 	 <p>06</p> <p>1577</p> <p>Delivery time DICEMBER 2016</p> <p>KAX1</p> 	 <p>06</p> <p>1716</p> <p>Delivery time DICEMBER 2016</p> <p>MSL4R</p> 
	FOR: MASTER LOCK PER:	FOR: SOLEX PER:	
	 <p>06</p> <p>1716</p> <p>Delivery time DICEMBER 2016</p> <p>MSL5R</p> 	 <p>06</p> <p>1385</p> <p>Delivery time NOVEMBER 2016</p> <p>SLX1</p> 	
	<p>01</p> <p>COMMERCIAL GROUP GRUPPO COMMERCIALE PREISEGRUPPE GROUPE COMMERCIAL GRUPO COMMERCIAL GRUPO COMERCIAL</p> <p>www.silca.biz</p>		

ALL THE KEYS DISPLAYED ARE AVAILABLE ALSO IN THE SILCA "NEW KEY COLLECTION"



New Keys / Chiavi Nuove / Neue Schlüssel / Nouvelles Clés / Llaves Nuevas / Chaves Nuevas

FOR: PER:	3T	CAM	FOR / PER
	<p>Delivery time DICEMBER 2016</p> <p>19</p> <p>1718</p> <p>5.45</p> <p>72.5</p> <p>11.5</p> <p>26.2</p> <p>5TRT2</p>	<p>Delivery time DICEMBER 2016</p> <p>19</p> <p>1719</p> <p>5</p> <p>85</p> <p>13.8</p> <p>22</p> <p>5ACM7</p>	3T (RU) CAM (RU) METTEM (RU) TULA (RU)
FOR: PER:	METTEM	TULA	
	<p>Delivery time NOVEMBER 2016</p> <p>19</p> <p>1562</p> <p>4.92</p> <p>85</p> <p>12.3</p> <p>25.6</p> <p>5MEM5</p>	<p>Delivery time NOVEMBER 2016</p> <p>19</p> <p>1717</p> <p>5.6</p> <p>70</p> <p>12.2</p> <p>32.3</p> <p>5TOL3</p>	

01
 COMMERCIAL GROUP
 GRUPPO COMMERCIALE
 PREISEGRUPPE
 GROUPE COMMERCIAL
 GRUPO COMMERCIAL
 GRUPO COMMERCIAL

www.silca.biz

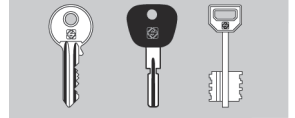

New Keys / Chiavi Nuove / Neue Schlüssel / Nouvelles Clés / Llaves Nuevas / Chaves Nuevas

FOR / PER
GUARDIAN (IT)

FOR:
 PER:
GUARDIAN

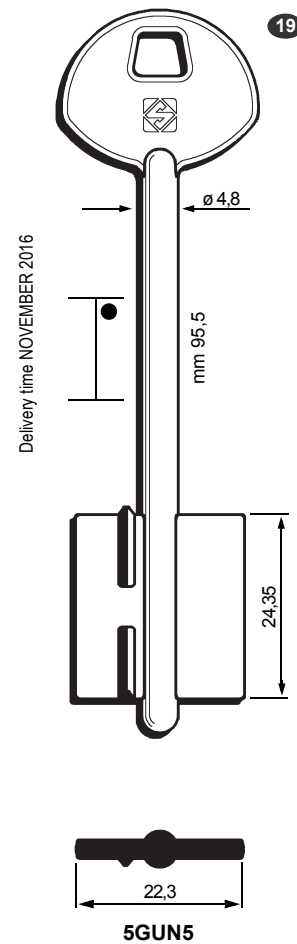
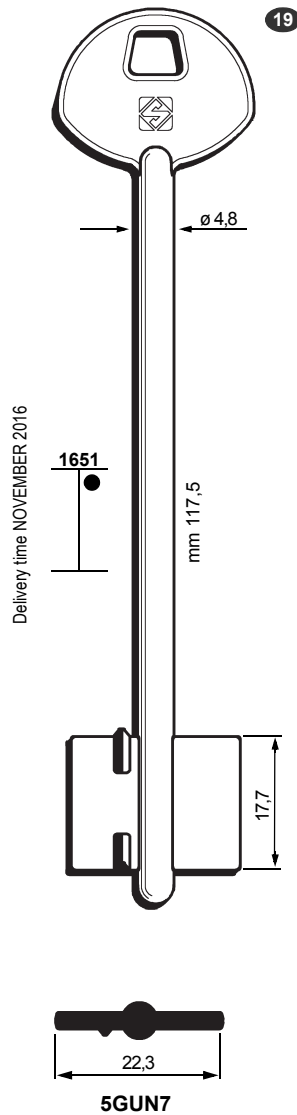

01

COMMERCIAL GROUP
 GRUPPO COMMERCIALE
 PREISEGRUPPE
 GROUPE COMMERCIAL
 GRUPO COMMERCIAL
 GRUPO COMERCIAL

















www.silca.biz

ALL THE KEYS DISPLAYED ARE AVAILABLE ALSO IN THE SILCA "NEW KEY COLLECTION"



Car Keys Guide / Guida Chiavi Auto / Handbuch für Autoschlüssel / Guide Clés pour Voitures
 Guía Llaves para Coches / Guia Chaves para Carros

New Updates

1	2	2a	3	3a	3b	E3 / E4 / E2			6	42+71	72	43 44a	12
						TRANSPONDER INFO				IGNITION			
													
CAR MAKE MODEL	FROM	TO	SILCA REF.	SILCA REF.	SILCA REF.	TRANSP. COPY	TRANSP. PROGR.	GEN. ON GTI	TRANSP. TYPE	FAST COPY PLUS RW4 PLUS FAST COPY / RW4	FAST COPY PLUS RW4 PLUS	FAST COPY RW4 + P-BOX/M-BOX	STP
													

For more info on the uses of car keys, refer to the Silca Electronic Key Catalogue:



OPEL-VAUXHALL®

COMBO	2002	2006	HU46T12		HU46FH		T12		PH / CR	40			
COMBO	2002	2006	HU46AT12		HU46FH		T12		PH / CR	40			
COMBO	2007	2011	HU100T12	HU100TE	HU100FH		T12		PH / CR	40			
COMBO	2007	2011	HU100AT12	HU100TE	HU100FH		T12		PH / CR	40			
COMBO	2012			SIP22TE	SIP22FH	GTI/MH			PH / CR2	46			
COMBO	2012		SIP22MH	SIP22TE	SIP22FH	GTI/MH			PH / CR2	46	Y	P-BOX	

RENAULT-DACIA®

VARIOUS MODELS	2010		HU136										
----------------	------	--	-------	--	--	--	--	--	--	--	--	--	--

See also the "Vehicle Guide Legend" / Vedi anche la "Legenda Guida Veicoli" / Siehe auch die "Fahrzeugschlüssel Erläuterung" / Voir aussi la "Légende Guide Véhicules" / Véase también la "Leyenda Guía para Vehículos" / Veja também a "Legenda Guia para Veículos"

The uses of the keys are purely indicative and may be subject to updates and revisions. / Gli utilizzi delle chiavi sono da considerarsi puramente indicativi e possono essere oggetto di aggiornamenti e revisioni. / Die Abbildung und technischen Daten der Schlüssel sind nicht bindend. Silca behält sich Änderungen am Produkt, die zur Verbesserung beitragen, vor. / Les usages des clés sont purement indicatifs; ils peuvent être mis à jour et revus. / Los usos de las llaves deben considerarse puramente indicativos y pueden ser objeto de actualizaciones y revisiones. / As utilizações das chaves devem ser consideradas puramente indicativas e podem ser objecto de actualizações e revisões.

© Registered Trademarks. / © Marchi Registrati. / © Eingetragene Marken. / © Marques Déposées. / © Marcas Registradas. / © Marcas Registradas.



FUTURA PRO

Futura Pro

Futura Pro is the only electronic key cutting machine able to duplicate all types of residential and automotive keys.

- Exclusive double cutting station for flat, cruciform, laser and dimple keys.
- Faster cutting cycles thanks to a motor that delivers up to three times more power and cutters that reach speeds of 1585 rpm for flat keys and 12100 rpm for laser and dimple keys.
- New, upgraded tablet and electronics deliver both faster response times and an all-round improvement in the machine performance.
- The machine is equipped with 2 USB ports at the rear: one for the tablet battery charger and one for USB connection.
- "Total black" new look. Revamped details include the new tool holder mat on the top of the machine and the protective motor cover made of polished steel.
- New software features: shortcut function for vehicle key cutting code searches, key cut preview also for laser keys, guided updating procedure.

Futura Pro

Futura Pro è l'unica duplicatrice elettronica in grado di cifrare tutti i tipi di chiavi residenziali e automotive.

- Esclusiva doppia stazione di taglio per chiavi piatte, a croce, laser e punzonate.
- Cicli di taglio più veloci grazie al motore fino a 3 volte più potente e alle frese che raggiungono velocità di 1585 giri/min per chiavi piatte e 12100 giri/min per chiavi laser e punzonate.
- Il nuovo tablet e le nuove componenti elettroniche assicurano tempi di risposta più rapidi e un complessivo miglioramento delle performance della macchina.
- La macchina è dotata di 2 porte USB sul retro: una per la ricarica della batteria del tablet e una per la connessione USB.
- Nuovo stile "total black". Fra i dettagli rinnovati: il nuovo tappetino dell'area porta-oggetti sopra la macchina e la copertura del motore in acciaio lucido.
- Nuove funzioni software: ricerca semplificata scheda di taglio chiavi veicolo, anteprima del taglio anche per chiavi laser, procedura guidata di aggiornamento.

Futura Pro

Futura Pro ist die elektronische Fräsmaschine, die nahezu alle Wohnungs- und Fahrzeugschlüsseltypen fräsen kann.

- Doppelte Frässtation für Flach-, Kreuzbart-, Bahnen- und Bohrmuldenschlüssel.
- Schnelle Fräszyklen dank des bis zu dreimal leistungsstärkeren Motors und der Fräser, die eine Geschwindigkeit von 1585 Umdrehungen/Min. für Flachslüssel und 12100 Umdrehungen/Min. für Bahnen- und Bohrmuldenschlüssel erreichen.
- Das neue Tablet und die neuen elektronischen Komponenten garantieren schnellere Reaktionszeiten und eine Verbesserung der Maschinenleistung insgesamt.
- Die Maschine verfügt über 2 USB-Buchsen: eine für das Aufladen der Tablet-Batterie und eine für die USB-Verbindung.
- Neue „Total Black“-Look. Zu den neuen Design-Details gehören die neue Unterlage für den Werkzeughalterbereich und die Motorabdeckung aus glänzendem Stahl.
- Neue Software-Funktionen: vereinfachte Schneidkartensuche der Fahrzeugschlüssel, Vorschau des Fräsergebnisses auch für Bahnschlüssel, softwaregeführte Updates.

> [More info on all Silca websites](#)



■ Futura Pro

Futura Pro est la seule machine électronique pour tailler tous les types de clés à usage domestique et pour l'automobile.

- Double station de taillage exclusive pour clés plates, cruciformes, laser et à points.
- Cycles de taillage plus rapides grâce à un moteur jusqu'à 3 fois plus puissant et à des fraises qui arrivent à 1585 rpm pour les clés plates et à 12100 rpm pour les clés laser et à points.
- La tablette et les nouveaux éléments électroniques garantissent des temps de réponse plus rapides et une amélioration globale des performances de la machine.
- La machine est dotée de 2 ports USB à l'arrière : un pour la recharge de la batterie de la tablette et un pour la connexion USB.
- Nouveau style "total black". Parmi les détails renouvelés: le nouveau tapis du rangement porte-outils sur la machine et le couvercle du moteur en acier poli.
- Nouvelles fonctions du logiciel: recherche simplifiée de la fiche de taillage des clés véhicule, aperçu préliminaire du taillage même pour les clés laser, procédure de mise à jour guidée.



Flat and cruciform key cutting station

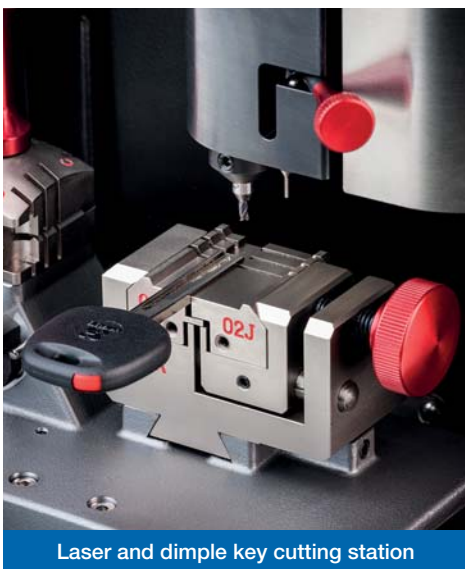

Laser and dimple key cutting station

■ Futura Pro

Futura Pro es la única duplicadora electrónica que corta todos los tipos de llaves residenciales y para vehículos.

- Estación doble de corte para llaves planas, en cruz, de regata y de seguridad.
- Ciclos de corte más rápidos con un motor hasta 3 veces más potente y con las fresas que alcanzan una velocidad de 1585 r.p.m para llaves planas y 12100 r.p.m para llaves de regata y de seguridad.
- La nueva tableta y los nuevos componentes electrónicos aseguran tiempos de respuesta más rápidos y una mejora total de las prestaciones de la máquina.
- La máquina tiene 2 puertos USB en la parte trasera: uno para la carga de la batería de la tableta y otra para la conexión USB.
- Nuevo estilo "total negro". Entre los elementos renovados se incluyen la nueva cinta de la zona porta-objetos sobre la máquina y el revestimiento del motor en acero brillante.
- Nuevas funciones del software: búsqueda simplificada de la ficha de corte de llaves del vehículo, previsualización del corte también para llaves de regata, procedimiento guiado de actualización.

■ Futura Pro

Futura Pro é a única duplicadora eletrônica capaz de cortar todos os tipos de chaves de habitações e automotivo.

- Exclusiva estação de corte dupla para chaves planas, tetra, laser e de pontos.
- Ciclos de corte mais rápidos graças ao motor até 3 vezes mais potente e às fresas de 1585 r.p.m. para chaves planas e de 12100 r.p.m. para chaves laser e de pontos.
- O novo tablet e os novos componentes eletrônicos asseguram tempos de resposta mais rápidos e um melhoramento geral dos rendimentos da máquina.
- A máquina está provida de 2 portas USB na parte traseira: uma para a recarga da bateria do tablet e uma para a ligação USB.
- Novo estilo "total black". Entre os detalhes renovados: o tapete da área porta-objects e a cobertura do motor de aço polido.
- Novas funções software: pesquisa simplificada da ficha de corte das chaves de veículo, antevisão do corte também em chaves laser, processo assistido de atualização.

TYPES OF DUPLICATED KEYS

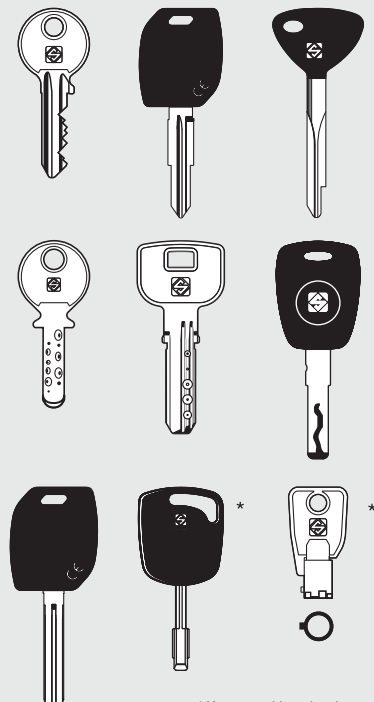

* Keys cut with optional accessories

> More info on all Silca websites

Silca Key Programs - WEB Update

SKP - WEB UPDATE

A new update of the SILCA KEY PROGRAMS software is available to all WEB subscribers.

Check out the "News" section of Silca Key Programs on www.silca.biz to know more.

SKP - MISE À JOUR WEB

Une nouvelle mise à jour du logiciel SILCA KEY PROGRAMS pour tous les abonnements WEB est disponible.

Consultez la section "Nouveautés" de Silca Key Programs sur notre site www.silca.biz pour en savoir plus.

SKP - AGGIORNAMENTO WEB

È disponibile un nuovo aggiornamento del software SILCA KEY PROGRAMS per tutti gli abbonati WEB.

Consulta la sezione "Novità" di Silca Key Programs sul sito www.silca.biz per saperne di più.

SKP - ACTUALIZACIÓN WEB

Una nueva actualización del software SILCA KEY PROGRAMS para todos los abonados WEB está disponible.

Visite la sección "Novedades" de Silca Key Programs en el sitio www.silca.biz para más informaciones.

SKP - AKTUALISIERUNG WEB

Für alle WEB Abonnenten ist eine neue Aktualisierung von der Software SILCA KEY PROGRAMS verfügbar.

Im Bereich "Neuheiten" auf der Internetseite www.silca.biz finden Sie weitere Informationen.

SKP - ATUALIZAÇÃO WEB

Nova atualização do software SILCA KEY PROGRAMS para todos o assinantes WEB está disponível.

Consulte a seção "Novidades" de Silca Key Programs no site www.silca.biz para saber mais.

SILCA FUTURA PROGRAM

Data Update with new systems

Software Vers. 2.21.0 - db 3.07

App Vers. 1.21



Futura

Data update with new systems / Aggiornamento dati con nuovi sistemi / Datenaktualisierung mit neuen Systemen / Mise à jour des données avec nouveaux systèmes / Actualización de datos con sistemas nuevos / Atualização de dados com novos sistemas

New items include / Tra le novità / Unter den Neuheiten / Parmi les nouveautés / Entre las novedades / Entre as novidades:

- Abus® Vela 1000
- Abus® Vela 2000
- Basi® 16BM
- Dom® IX6 SR S (prof. 250 / 251 / 252 / 253 / 254)
- M&C® Matrix
- Renault-Dacia®
- Schlage® AUB system
- Securemme® Evok 22 (11 pin)
- Securemme® Evok 64 (11 pin)
- Securemme® Evok 64 (10 pin)

New Key Programming Software ADS258 for Fiat® 2016 Vehicles

November 2016



UK Advanced Diagnostics has released the Fiat® 2016 **ADS258 key programming software, which now includes pincode reading and precoding for the Fiat® 500 and various other models.** Precoding can be performed seamlessly in the background using Smart Aerial and Smart Dongle or RW4 Plus/Fast Copy Plus and the cable ADC234.

IT Advanced Diagnostics ha sviluppato il software ADS258 Fiat® 2016 che consente di **leggere il codice pin e di pre-codificare le chiavi auto utilizzate su Fiat® 500 e altri modelli veicolo.** La pre-codifica può essere effettuata in background utilizzando Smart Aerial e Smart Dongle o RW4 Plus/Fast Copy Plus e il cavo ADC234.

DE Advanced Diagnostics hat die neue Software Fiat® 2016 ADS258 für den Einsatz an zahlreichen Fiat® Fahrzeugmodellen entwickelt. **Mit der Programmiersoftware ADS258 ist es möglich, den PIN-Code zu lesen und die Kfz-Schlüssel für den Fiat® 500 und weitere Fahrzeugmodelle vorzucodieren.** Das Vorcodieren kann im Hintergrund mit Hilfe von Smart Aerial und Smart Dongle oder RW4 Plus/Fast Copy Plus und dem Kabel ADC243 erfolgen.

FR Advanced Diagnostics a développé le nouveau logiciel Fiat® 2016 **ADS258 pour lire le code pin et de pré-coder les clés auto utilisées sur les Fiat® 500 et autres modèles de véhicules.** Avec ADS258 vous pourrez pré-coder en background avec Smart Aerial et Smart Dongle ou RW4 Plus/Fast Copy Plus et le câble ADC243.

ES Advanced Diagnostics ha desarrollado el nuevo software de programación de llaves para vehículos Fiat® 2016 ADS258 **que ahora incluye la lectura del código pin y del código de precodificación para el modelo Fiat® 500 y otros modelos.** La precodificación del transponder puede realizarse utilizando el Smart Aerial y el Smart Dongle o Fast Copy Plus/RW4 Plus y el cable ADC243

PT A Advanced Diagnostics desenvolveu o novo software Fiat® 2016 **ADS258 para ler o código pin e pré-codificar as chaves carro utilizadas em Fiat® 500 e outros modelos de veículo.** A pré-codificação pode ser realizada em background utilizando Smart Aerial e Smart Dongle ou com o dispositivo RW4 Plus/Fast Copy Plus e o cabo ADC243.

DETAILS OFFER

Cable	ADC250 or ADC251
Dongle	Smart Dongle + Smart Aerial or RW4 Plus/Fast Copy Plus + ADC243 Cable
Software category	A
Other software required	ADS185
Smart card	Smart Dongle

© All the brands and product names mentioned in this flyer are registered trademarks exclusive property of authorized manufacturers. Said trademarks or trade names are nominated only for the purposes of information in order to be rapidly identified.

www.silca.biz - www.silca-automotive.com - www.advanced-diagnostics.com



Software Applications

Fiat® ADS258

TABLE

										
Alfa® Romeo Mito (Blade) 2008 to 2015	✓	✓	✓	✓	✓	ADC250 or ADC251	Smart Dongle	✗	ID46	SIP22TE
Fiat® 500 (Blade) 2007 to 2015	✓	✓	✓	✓	✓	ADC250 or ADC251	Smart Dongle	✗	ID46	SIP22TE
Fiat® Grande Punto (Blade) 2011 onwards	✓	✓	✓	✓	✓	ADC250 or ADC251	Smart Dongle	✗	ID46	SIP22TE
Fiat® Panda (Blade) 2011 onwards	✓	✓	✓	✓	✓	ADC250 or ADC251	Smart Dongle	✗	ID46	SIP22TE
Ford® Ka (Blade) 2008 onwards	✓	✓	✓	✓	✓	ADC250 or ADC251	Smart Dongle	✗	ID46	SIP22TE
Citroën® Nemo (Blade)* 2007 to 2015	✓	✓	✓	✓	✓	ADC250 or ADC251	Smart Dongle	✗	ID46	SIP22TE
Fiat® Doblò (Blade)* 2009 to 2015	✓	✓	✓	✓	✓	ADC250 or ADC251	Smart Dongle	✗	ID46	SIP22TE
Fiat® Fiorino (Blade)* 2008 to 2015	✓	✓	✓	✓	✓	ADC250 or ADC251	Smart Dongle	✗	ID46	SIP22TE
Fiat® Qubo (Blade)* 2008 to 2015	✓	✓	✓	✓	✓	ADC250 or ADC251	Smart Dongle	✗	ID46	SIP22TE
Opel®-Vauxhall® Combo (Blade)* 2012 onwards	✓	✓	✓	✓	✓	ADC250 or ADC251	Smart Dongle	✗	ID46	HU100TE
Peugeot® Bipper (Blade)* 2008 to 2015	✓	✓	✓	✓	✓	ADC250 or ADC251	Smart Dongle	✗	ID46	SIP22TE

* No precoding available for AD100 Pro Truck. / Precodifica non disponibile per il dispositivo AD100 Pro Truck. / Vorcodieren nicht verfügbar für das Gerät AD100 Pro Truck. / Pré-codage non disponible sur le dispositif AD100 Pro Truck. / Precodificación no disponible para dispositivos AD100 Pro Truck. / Pré-codificação não disponível para o dispositivo AD100 Pro Truck.

Important Note: To prevent damage to Smart Dongle, ensure that the ignition is turned off when connecting the programmer to the vehicle. / **Nota importante:** per prevenire eventuali danni al dispositivo Smart Dongle, assicurarsi che il motore sia spento nel momento in cui il dispositivo di programmazione viene collegato al veicolo. / **Wichtige Information:** Um Beschädigungen am Smart Dongle zu vermeiden, stellen Sie bitte sicher, dass die Zündung ausgeschaltet ist, wenn das Programmiergerät mit dem Fahrzeug verbunden wird. / **Remarque importante:** pour prévenir d'éventuels dégâts sur le dispositif Smart Dongle, assurez-vous que le moteur soit éteint au moment où le dispositif de programmation est connecté au véhicule. / **Nota importante:** para prevenir cualquier daño al Smart Dongle, asegúrese de que el contacto está apagado cuando conecte el dispositivo de programación al vehículo. / **Anotação importante:** para prevenir eventuais danos no dispositivo Smart Dongle, certificar-se de que o motor está desligado no momento em que o dispositivo de programação é ligado ao veículo.

© All the brands and product names mentioned in this flyer are registered trademarks exclusive property of authorized manufacturers. Said trademarks or trade names are nominated only for the purposes of information in order to be rapidly identified.

www.silca.biz - www.silca-automotive.com - www.advanced-diagnostics.com

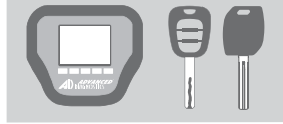

New Key Programming Software ADS257 for Ford® 2016 Vehicles

November 2016



 Advanced Diagnostics are pleased to announce the release of Ford® 2016 **ADS257 software which programs bladed and proximity keys for various Ford® vehicles worldwide.** For an improved, time saving and streamlined procedure ADS257 software bypasses the incode / outcode procedure making the process seamless and quick.

 Advanced Diagnostics ha sviluppato il nuovo software Ford® 2016 **ADS257 per programmare chiavi con canna metallica e chiavi di prossimità per diversi modelli Ford® diffusi in tutto il mondo.** ADS257 è in grado di bypassare le procedure di sicurezza di incode e outcode, rendendo la programmazione della chiave semplice e veloce.

 Advanced Diagnostics hat die neue Software Ford® 2016 ADS257 entwickelt. **Mit ADS257 kann man Schlüssel mit Metallschaft und Keyless-Schließsysteme für verschiedene, weltweit verbreitete Fahrzeugmodelle der Marke Ford® programmieren.** Die Software ADS257 umgeht die Incode- und Outcode-Sicherheitsverfahren und macht die Schlüsselprogrammierung einfach und schnell.

 Advanced Diagnostics a développé un nouveau logiciel Ford® 2016 **ADS257 pour programmer des clés de démarreurs et des clés de proximité pour différents modèles Ford® diffus dans le monde.** Le logiciel ADS257 est en mesure de contourner les procédures de sécurité in-code et out-code ; programmer la clé devient donc plus simple, plus rapide et sans interruption.



 Advanced Diagnostics ha desarrollado el nuevo software Ford® 2016 **ADS257 para programar llaves de proximidad y de no proximidad en vehículos Ford® de todo el mundo.** Para mejorar el tiempo de respuesta durante el procedimiento de programación, el software ADS257 salta la seguridad del vehículo haciendo el proceso mucho más sencillo y rápido.

 A Advanced Diagnostics desenvolveu o novo software Ford® 2016 **ADS257 para programar chaves com cana metálica e chaves de proximidade para vários modelos Ford® difundidos em todo o mundo.** O software ADS257 pode evitar os procedimentos de segurança de incode e outcode, tornando a programação da chave simples, rápida e sem interrupções.

DETAILS OFFER

Cable	ADC250 or ADC251
Dongle	Smart Dongle
Software category	A
Other software required	None
Smart card	Smart Dongle

© All the brands and product names mentioned in this flyer are registered trademarks exclusive property of authorized manufacturers. Said trademarks or trade names are nominated only for the purposes of information in order to be rapidly identified.

www.silca.biz - www.silca-automotive.com - www.advanced-diagnostics.com

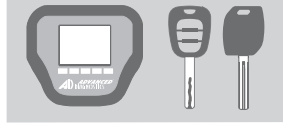

Software Applications

Ford® ADS257

TABLE

									
Ford® C-Max (Proximity) 2016	✓	✓	✗	✗	✗	ADC250 or ADC251	Smart Dongle	✓	HU101TE*
Ford® Transit (Blade) 2013 onwards (all variants)	✓	✓	✗	✗	✗	ADC250 or ADC251	Smart Dongle	✓	HU101TE
Ford® Transit Custom (Blade) 2014 onwards (all variants)	✓	✓	✗	✗	✗	ADC250 or ADC251	Smart Dongle	✓	HU101TE
Ford® Focus (Proximity) 2015 onwards	✓	✓	✗	✗	✗	ADC250 or ADC251	Smart Dongle	✓	HU101TE*

* Compatible key profile. Please note that the key can be used only as security blade - not for vehicle ignition. / * Profilo chiave compatibile. La chiave può essere utilizzata solo come security blade - non per l'accensione del veicolo. / * Kompatibles Schlüsselprofil. Der Schlüssel kann nur als Security Blade verwendet werden – nicht zum Starten des Fahrzeugs. / * Profil clé compatible. La clé peut être utilisée comme security blade seulement, jamais pour démarrer le véhicule. / * Perfil de llave compatible. Por favor tenga en cuenta que para los modelos con sistema proximidad el espadín de este perfil se utiliza sólo como acceso al vehículo. / * Perfil de chave compatível. A chave só pode ser utilizada como security blade – não para a ignição do veículo.

Important Note: To prevent damage to Smart Dongle, ensure that the ignition is turned off when connecting the programmer to the vehicle. / **Nota importante:** per prevenire eventuali danni al dispositivo Smart Dongle, assicurarsi che il motore sia spento nel momento in cui il dispositivo di programmazione viene collegato al veicolo. / **Wichtige Information:** Um Beschädigungen am Smart Dongle zu vermeiden, stellen Sie bitte sicher, dass die Zündung ausgeschaltet ist, wenn das Programmiergerät mit dem Fahrzeug verbunden wird. / **Remarque importante:** pour prévenir d'éventuels dégâts sur le dispositif Smart Dongle, assurez-vous que le moteur soit éteint au moment où le dispositif de programmation est connecté au véhicule. / **Nota importante:** para prevenir cualquier daño al Smart Dongle, asegúrese de que el contacto está apagado cuando conecte el dispositivo de programación al vehículo. / **Anotação importante:** para prevenir eventuais danos no dispositivo Smart Dongle, certificar-se de que o motor está desligado no momento em que o dispositivo de programação é ligado ao veículo.

© All the brands and product names mentioned in this flyer are registered trademarks exclusive property of authorized manufacturers. Said trademarks or trade names are nominated only for the purposes of information in order to be rapidly identified.

www.silca.biz - www.silca-automotive.com - www.advanced-diagnostics.com



SILCA NEWS 12/16

ALL THE NEW KEYS, AUTOMOTIVE SOLUTIONS, KEY CUTTING MACHINES, SOFTWARE UPDATES AND MUCH MORE

Contents

<u>New Keys</u>	1
<u>Vehicle Keys Guide</u>	2-3
<u>MySilca App - Barcode Ordering</u>	4-5
<u>SKP Update 3/2016</u>	6-7-8-9
<u>Key Cutting Machine Accessories</u>	10-11





MySilca App - Barcode Ordering



Silca Key Programs Update 3/2016



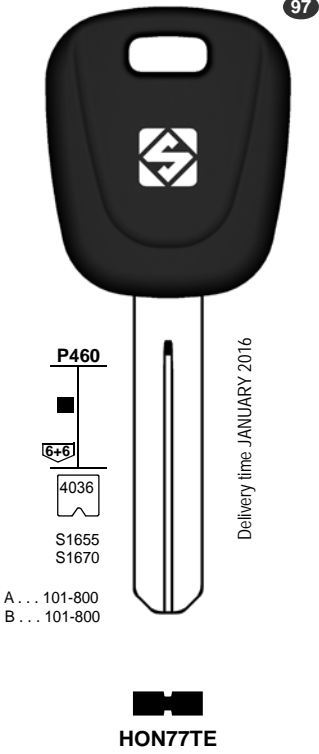

















New Keys / Chiavi Nuove / Neue Schlüssel / Nouvelles Clés / Llaves Nuevas / Chaves Nuevas

<p>FOR: PER:</p>	<p>HONDA</p>  <p>97</p> <p>P460</p> <p>6+6</p> <p>4036</p> <p>S1655 S1670</p> <p>A ... 101-800 B ... 101-800</p> <p>Delivery time JANUARY 2016</p> <p> HON77TE</p>	<p>FOR / PER</p>
<p>FOR: PER:</p>	<p>HONDA (J)</p>	<p>01</p> <p>COMMERCIAL GROUP GRUPPO COMMERCIALE PREISEGRUPPE GROUPE COMMERCIAL GRUPO COMMERCIAL GRUPO COMERCIAL</p> <p>www.silca.biz</p>



Car Keys Guide / Guida Chiavi Auto / Handbuch für Autoschlüssel / Guide Clés pour Voitures
Guía Llaves para Coches / Guia Chaves para Carros



















New Updates

1	2	2a	3	3a	3b	E3 / E4 / E2			6	42+71	72	43 44a	12
						TRANSPONDER INFO				IGNITION			
													
CAR MAKE MODEL	FROM	TO	SILCA REF.	SILCA REF.	SILCA REF.	TRANSP. COPY	TRANSP. PROGR.	GEN. ON GTI	TRANSP. TYPE	FAST COPY PLUS RW4 PLUS FAST COPY / RW4	FAST COPY PLUS RW4 PLUS	FAST COPY RW4 + P-BOX/M-BOX	STP
													
For more info on the uses of car keys, refer to the Silca Electronic Key Catalogue: 													
HONDA®													
JAZZ	2015			HON66TE	HON66FH				PH / CR3	49-1C			
HYUNDAI®													
I10	2014				TOY49FH				PH / CR3	49-1C			
MITSUBISHI®													
COLT	2005	2010	MIT11RMH	MIT11RTE	MIT11RFH	GTI/MH			PH / CR2	46	Y	P-BOX	
COLT	2005	2010		MIT11RTE	MIT11RFH			Y	PH / CR2	46			
NISSAN®													
FRONTIER	2014		NSN14T14	NSN14TE	NSN14FH			Y	PH / CR2	46			
FRONTIER	2014		NSN14MH	NSN14TE	NSN14FH	GTI/MH			PH / CR2	46	Y	P-BOX	
KING CAB	2008	2011	NSN14T14	NSN14TE	NSN14FH		T14	Y	PH / CR2	46			
LIVINA	2009	2013	NSN14T14	NSN14TE	NSN14FH		T14	Y	PH / CR2	46			
LIVINA	2009	2013	NSN14MH	NSN14TE	NSN14FH	GTI/MH			PH / CR2	46	Y	P-BOX	
NV200	2009	2013		NSN14TE	NSN14FH				PH / CR2	46			
NV200	2009	2013	NSN14MH	NSN14TE	NSN14FH	GTI/MH			PH / CR2	46	Y	P-BOX	
TIIDA	2007	2011	NSN14T14	NSN14TE	NSN14FH		T14	Y	PH / CR2	46			
TIIDA	2007	2011	NSN14MH	NSN14TE	NSN14FH	GTI/MH			PH / CR2	46	Y	P-BOX	
OPEL-VAUXHALL®													
COMBO	2007	2011	HU100T12	HU100TE	HU100FH		T12		PH / CR	40			
COMBO	2007	2011	HU100AT12	HU100TE	HU100FH		T12		PH / CR	40			
COMBO	2012			SIP22TE		GTI/MH			PH / CR2	46			
COMBO	2012		SIP22MH	SIP22TE		GTI/MH			PH / CR2	46	Y	P-BOX	
TOYOTA®													
AVENSIS VERSO	2004	2009	TOY43AT31	TOY43ATE	TOY43FH		T31	Y	TEX / CR	67			
AVENSIS VERSO	2004	2009	TOY43MH	TOY43ATE	TOY43FH	GTI/MH			TEX / CR	67	Y	P-BOX	
COROLLA VERSO	2001	2004	TOY43AT4	TOY43TE	TOY43FH		T4	Y	TEXAS	4C			
COROLLA VERSO	2001	2004	TOY43MH	TOY43TE	TOY43FH	GTI/MH			TEXAS	4C	Y	P-BOX	
VOLKSWAGEN®													
MAGGIOLINO	2011	2013	HU66T24	HU66TE	HU66FH		T24		MEG / CR	48-A1			
MAGGIOLINO	2011	2013	HU66MH	HU66TE	HU66FH	T48			MEG / CR	48-A1	M-BOX	P-BOX,M-BOX	
NOUVELLE COCCINELLE	2011	2013	HU66T24	HU66TE	HU66FH		T24		MEG / CR	48-A1			
NOUVELLE COCCINELLE	2011	2013	HU66MH	HU66TE	HU66MH	T48			MEG / CR	48-A1			

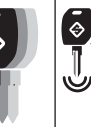

Motorcycle Keys Guide / Guida Chiavi Moto / Marktführer für Motorräderschlüssel Guide Clés pour Motocyclettes / Guía Llaves para Motocicletas / Guia Chaves para Motocicletas

New Updates

1	2	2a	3	3a	3b	E3 / E4 / E2			6	42+71	72	43 44a	12	
						TRANSPONDER INFO				IGNITION				
														
CAR MAKE MODEL	FROM	TO	SILCA REF.	SILCA REF.	SILCA REF.	TRANSP. COPY	TRANSP. PROGR.	GEN. ON GTI	TRANSP. TYPE	FAST COPY PLUS RW4 PLUS FAST COPY / RW4	FAST COPY PLUS RW4 PLUS	FAST COPY RW4 + P-BOX/M-BOX	STP	
														

For more info on the uses of motorcycles keys, refer to the Silca Electronic Key Catalogue: 

HONDA®

CBR650	2014		HON77TE	HON77TE		GTI	T14	Y	PH / CR2	46	Y	P-BOX	
CB500	2016		HON77TE	HON77TE		GTI	T14	Y	PH / CR2	46	Y	P-BOX	
CB650	2014		HON77TE	HON77TE		GTI	T14	Y	PH / CR2	46	Y	P-BOX	
INTEGRA	2012	2015	HON70T14	HON70TE	HON70FH		T14	Y	PH / CR2	46			
INTEGRA	2012	2015	HON70MH	HON70TE	HON70FH	GTI/MH			PH / CR2	46	Y	P-BOX	
INTEGRA	2016		HON77TE	HON77TE		GTI	T14	Y	PH / CR2	46	Y	P-BOX	
NC750	2014		HON77TE	HON77TE		GTI	T14	Y	PH / CR2	46	Y	P-BOX	

See also the "Vehicle Guide Legend" / Vedi anche la "Legenda Guida Veicoli" / Siehe auch die "Fahrzeugschlüssel Erläuterung" / Voir aussi la "Légende Guide Véhicules" / Véase también la "Leyenda Guía para Vehículos" / Veja também a "Legenda Guia para Veículos"

The uses of the keys are purely indicative and may be subject to updates and revisions. / Gli utilizzi delle chiavi sono da considerarsi puramente indicativi e possono essere oggetto di aggiornamenti e revisioni. / Die Abbildung und technischen Daten der Schlüssel sind nicht bindend. Silca behält sich Änderungen am Produkt, die zur Verbesserung beitragen, vor. / Les usages des clés sont purement indicatifs; ils peuvent être mis à jour et revus. / Los usos de las llaves deben considerarse puramente indicativos y pueden ser objeto de actualizaciones y revisiones. / As utilizações das chaves devem ser consideradas puramente indicativas e podem ser objecto de actualizações e revisões.

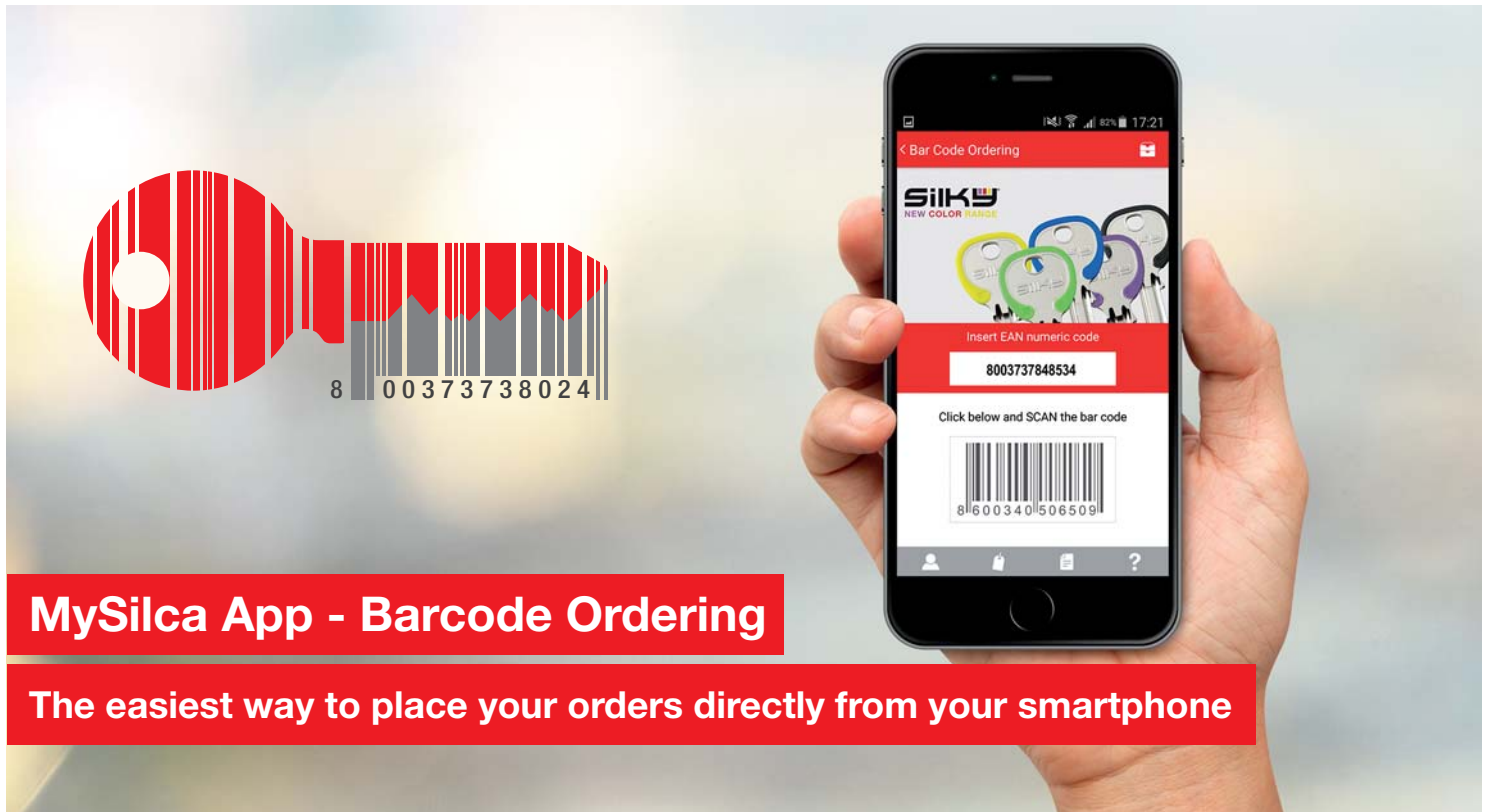

MySilca App - Barcode Ordering

The easiest way to place your orders directly from your smartphone

Barcode Ordering

MySilca Barcode Ordering is the simplest and quickest way to order Silca products. Designed for all those who are ordering Silca products, either directly via Silca or via Wholesaler/Distributor.

HOW IT WORKS

1. Download MySilca App from Google Play Store or App Store (or update your existing MySilca version) and install it.
2. Look for Silca barcodes directly on product boxes, on barcoded Silca catalogues, on barcoded Silca key tags and take a picture of the codes you want to order.
3. Modify the single product quantity according to your needs.
4. Check your order summary.
5. Choose or confirm your order address from your address book and confirm the shipping address.
6. Send the order: the entire process is successfully completed.

Barcode Ordering

MySilca Barcode Ordering è il modo più facile e veloce per ordinare i prodotti Silca. Pensata per chi ordina prodotti Silca: sia che li acquisti direttamente da Silca che via Grossista o Distributore.

COME FUNZIONA

1. Scarica MySilca App da Google Play Store o App Store (o aggiorna la MySilca App alla versione più recente) e installala.
2. Cerca direttamente i codici a barre Silca dalle scatole dei prodotti, dai cataloghi con i Barcode, dai bindelli e fai una foto del codice a barre del prodotto che vuoi ordinare.
3. Aggiorna la quantità di un singolo prodotto modificandola secondo le tue necessità.
4. Controlla il sommario dell'ordine.
5. Scegli l'indirizzo di spedizione dalla tua rubrica e confermallo.
6. Spedisci l'ordine: l'intero processo è stato completato con successo.

Barcode Bestellung

MySilca App Barcode Bestellung ist die einfachste und schnellste Lösung, um Silca-Produkte zu bestellen. Diese App bietet verschiedene direkte oder indirekte Einkaufsmöglichkeiten.

WIE ES FUNKTIONIERT

1. Laden Sie MySilca App vom Google Play Store oder vom App Store herunter (oder aktualisieren Sie MySilca App mit der neuesten Version) und installieren Sie diese.
2. Suchen Sie die Barcodes direkt auf den Produktpackungen, in den Katalogen mit den Barcodes und auf den Leitkarten und fotografieren Sie den Barcode des Artikels, den Sie bestellen möchten.
3. Aktualisieren Sie die Anzahl des einzelnen Produkts und ändern Sie sie je nach Bedarf.
4. Kontrollieren Sie die Bestellsübersicht.
5. Wählen Sie die Versandanschrift aus dem Adressbuch aus und bestätigen Sie sie.
6. Senden Sie die Bestellung ab. Der gesamte Vorgang wurde erfolgreich abgeschlossen.

> More info on all Silca websites



Barcode Ordering

MySilca Barcode Ordering est le mode le plus facile et le plus rapide pour commander les produits Silca. Pensé pour ceux qui commandent des produits Silca qu'il s'agisse d'achat direct ou par l'intermédiaire d'un grossiste ou d'un revendeur.

COMMENT ÇA MARCHÉ

1. Télécharger MySilca App sur Google Play Store ou sur App Store (ou mettre MySilca App à jour sur la dernière version) et l'installer.
2. Chercher directement les codes barres sur les emballages des produits Silca, dans les catalogues avec les codes barres ou sur les étiquettes de fond de brochures du produit à commander.
3. Mettre à jour la quantité de chaque produit et la modifier selon vos besoins.
4. Contrôler le récapitulatif de la commande.
5. Choisir l'adresse d'expédition dans votre répertoire et valider.
6. Envoyer la commande. La procédure a bien abouti.

Barcode Ordering

MySilca Barcode Ordering es el modo más fácil y rápido para pedir los productos Silca. Pensada para quienes piden productos Silca: comprándolos directamente a Silca o a un mayorista o distribuidor.

¿CÓMO FUNCIONA?

1. Bájate MySilca App de Google Play o App Store (o actualiza la MySilca App con la versión más reciente) e instálala.
2. Busca directamente los códigos de barras en los paquetes de los productos Silca, en los catálogos con los códigos de barras, en las etiquetas y echa una foto al código de barras del producto que quieres pedir.
3. Actualiza la cantidad de un producto individual: puedes modificarlas en función de tus necesidades.
4. Controla el resumen del pedido.
5. Elige la dirección de envío en la agenda y confírmala.
6. Envía el pedido. Todo el proceso se ha completado correctamente.

Barcode Ordering

MySilca App Barcode Ordering é a maneira mais simples e rápida para encomendar os produtos Silca. Pensada para quem encomendar os produtos Silca: seja que os adquira directamente da Silca ou através do Grossista/Distribuidor.

COMO FUNCIONA

1. Descarregue MySilca App de Google Play Store ou App Store (ou atualize a MySilca App na versão mais recente) e instale-a.
2. Procure directamente os códigos de barras nas embalagens dos produtos Silca, dos catálogos com os Barcode, das etiquetas e tire uma fotografia do código de barras que deseja encomendar.
3. Atualize a quantidade de um produto individual modificando-a consoante as suas necessidades.
4. Controle o sumário da encomenda.
5. Escolha o endereço para o envio da lista de endereços e confirme-o.
6. Envie a encomenda: o inteiro procedimento foi completado com êxito

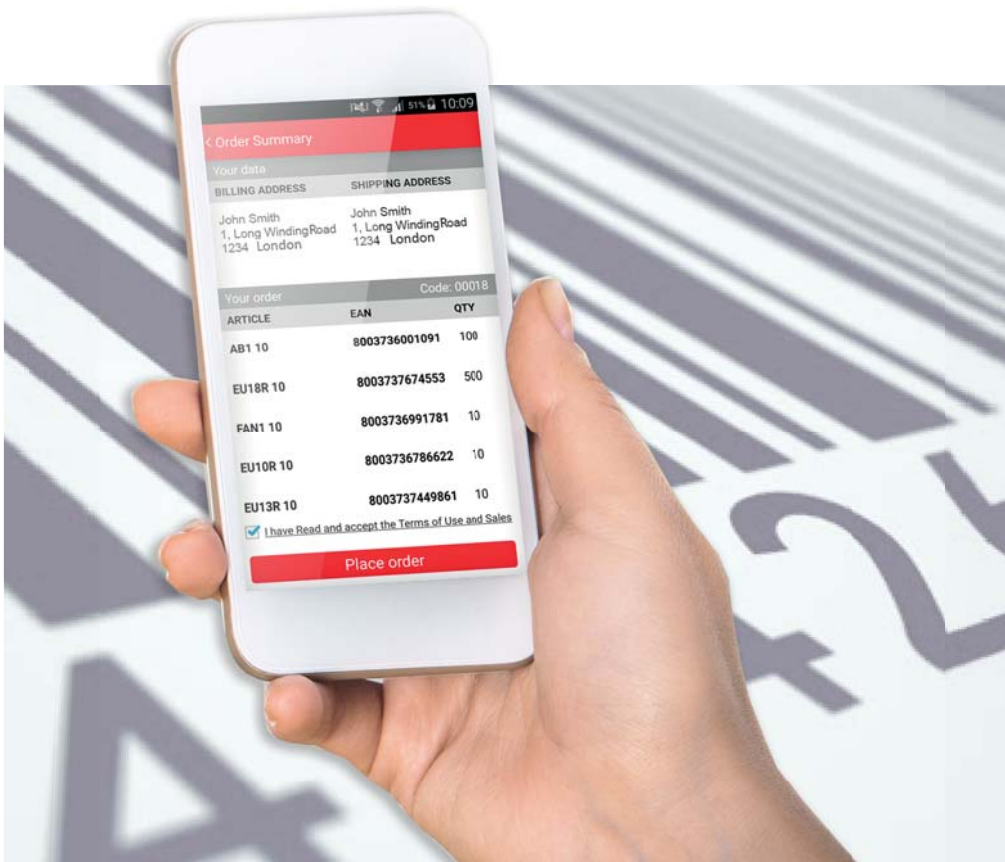

**Download MySilca from
Scarica MySilca da
Herunterladen Sie MySilca von
Téléchargez MySilca sur
Descargue MySilca de
Baixe MySilca de**



> More info on all Silca websites



Silca Key Programs

Update 3/2016 - SKP Vers. 21.2.x.xx

UPDATE 3/2016

New SKP 3/2016 Update for all WEB and DVD subscribers available in the "News" section of Silca Key Programs.

New items include:

- Data update with 4 new series (UC199, Unocode 299/399, Unocode 399 Evo, Unocode Pro).
- Data update with 28 new series (Quattrocode, Triax- e.code, Triax Quattro, Triax Pro).

MISE À JOUR 3/2016

Nouvelle mise à jour SKP 3/2016 pour tous les abonnés WEB et DVD disponible dans la section "Nouveautés" de Silca Key Programs.

Parmi les nouveautés:

- Mise à jour des données avec 4 nouvelles fiches (UC199, Unocode 299/399, Unocode 399 Evo, Unocode Pro).
- Mise à jour des données avec 28 nouvelles fiches (Quattrocode, Triax- e.code, Triax Quattro, Triax Pro).

AGGIORNAMENTO 3/2016

Nuovo Aggiornamento SKP 3/2016 per tutti gli abbonati WEB e DVD consultabile nella sezione "Novità" di Silca Key Programs.

Tra le novità:

- Aggiornamento Dati con 4 nuove serie (UC199, Unocode 299/399, Unocode 399 Evo, Unocode Pro).
- Aggiornamento Dati con 28 nuove serie (Quattrocode, Triax- e.code, Triax Quattro, Triax Pro).

ACTUALIZACIÓN 3/2016

Nueva actualización SKP 3/2016 para todos los abonados WEB y DVD disponible en la sección "Novedades" de Silca Key Programs.

Entre las novedades:

- Actualización Datos con 4 series nuevas (UC199, Unocode 299/399, Unocode 399 Evo, Unocode Pro).
- Actualización Datos con 28 series nuevas (Quattrocode, Triax- e.code, Triax Quattro, Triax Pro).

AKTUALISIERUNG 3/2016

Die Informationen zur neuen Aktualisierung des SKP 3/2016 für alle WEB und DVD Abonnenten ist in der Sektion "Neuheiten" des Silca Key Programs verfügbar.

Unter den Neuheiten:

- Datenaktualisierung mit 4 neuen Karten (UC199, Unocode 299/399, Unocode 399 Evo, Unocode Pro).
- Datenaktualisierung mit 28 neuen Karten (Quattrocode, Triax- e.code, Triax Quattro, Triax Pro).

ATUALIZAÇÃO 3/2016

Nova atualização SKP 3/2016 para todos o assinantes WEB e DVD disponível na seção "Novidades" de Silca Key Programs.

Entre as novidades:

- Atualização de Dados com 4 séries novas (UC199, Unocode 299/399, Unocode 399 Evo, Unocode Pro).
- Atualização de Dados com 28 séries novas (Quattrocode, Triax- e.code, Triax Quattro, Triax Pro).

> More info on all Silca websites

SILCA TRIAX - QUATTROCODE PROGRAM

Data Update with 28 new series

SKP Vers. 21.2.x.xx



Quattrocode



Triax-e.code



Triax Quattro



Triax Pro

Data update with 28 new series / Aggiornamento dati con 28 nuove serie / Daten-Aktualisierung mit 28 neuen Serien / Mise à jour des données avec 28 nouvelles séries / Actualización datos con 28 nuevas series / Atualização de dados com 28 novas séries.

New items include / Tra le novità / Unter den Neuheiten / Parmi les nouveautés / Entre las novedades / Entre as novidades:

- Abus® Vela 1000
- Abus® Vela 2000
- Amig® 10000
- Basi® I6BM
- Dom® IX6 SR S (prof. 250/251/252/253/254)
- Era® UCFTP (EA)
- Era® UCFTP (EB)
- Era® UCFTP (EC)
- Euro Locks® EU21P (2T-7/8W)
- Iseo® R9 Plus
- Kaba® ExperT Cross S1.0a (K89A)
- Kaba® ExperT Cross S1.0am (K89A)
- Kaba® ExperT Cross S1.0am (K89A) D. Code
- Kaba® ExperT Cross S1.0b (K89B)
- Kaba® ExperT Cross S1.0bm (K89B)
- Kaba® ExperT Cross S1.0bm (K89B) D. Code
- M&T® Champions Pro CP4 (C6LJ2)
- M&T® Champions Pro CP4 (C6LJK)
- Mauer® Crypto (6+6+6)
- Moia® MCGHYPC-C (6+3+3)
- Moia® MCHGYPC (7+4+3)
- Moia® MCHGYPC-M (7+4+3)
- Securemme® EVOK22 (11 Pin)
- Securemme® EVOK64 (10 Pin)
- Securemme® EVOK64 (11 Pin)
- Yale® Superior / Platinum (5+4+4)
- Yale® Superior / Platinum (4+3+4)
- Yale® Superior / Platinum (3+2+4)



Update the software on / Aggiornare il software di / Aktualisierung der Software von / Mettre à jour le logiciel de / Actualizar el software de / Atualizar o software de: Triax e-code, Triax Quattro, Triax Pro.

ATTENTION:

● A **new R30 clamp** that can house Triax Pro and Futura removable jaws has been introduced for the Quattrocode and Triax-e.code key-cutting machines. The R30 clamp is necessary only for the new lock systems developed by Silca with new jaws. All existing options for Quattrocode and Triax-e.code will not be replaced by removable jaws for the R30 clamp.

A R30 clamp that can house Triax Pro removable jaws has been introduced for the Triax Quattro key-cutting machine. All lock systems developed on the removable jaws of Triax Pro can also be used with the R30 clamp on the Triax Quattro.

To use the R30 clamp with the Triax-e.code, Triax 2 and Triax Quattro key-cutting machines, replace the U102TT and U103TT tracers on the Tracer Tower with a single O4TT tracer. The necessary instructions are included in the box of the optional R30 clamp (D746897ZB).

Triax Pro: all lock systems that can be used with the standard R29-01J-02J clamp have been implemented.

Triax-e.code and Triax 2: the machine memory is full.

This update implements all the lock systems already available on the Quattrocode, Triax Quattro and Triax Pro key-cutting machines. These systems and the new ones to be developed by Silca will be included **only** in Silca Key Programs and not incorporated into the machines. Therefore, Silca Key Programs is necessary to use the new systems with the Triax-e.code and Triax 2 key-cutting machines.

ATTENZIONE:

● Per le duplicatrici Quattrocode e Triax-e.code è stato introdotto il **nuovo morsetto R30** che può alloggiare le ganasce rimovibili di Triax Pro e Futura. Solo per i nuovi sistemi serratura sviluppati da Silca con nuove ganasce sarà necessario utilizzare il morsetto R30. Tutti gli opzionali esistenti per Quattrocode e Triax-e.code non saranno sostituiti da ganasce rimovibili per il morsetto R30.

● Per la duplicatrice Triax Quattro è stato introdotto il nuovo morsetto R30 che può alloggiare le ganasce rimovibili di Triax Pro. Tutti i sistemi serratura sviluppati in Triax Pro sulle ganasce rimovibili sono utilizzabili anche con il morsetto R30 sulla macchina Triax Quattro.

● Per utilizzare il morsetto R30 con le duplicatrici Triax-e.code, Triax 2 e Triax Quattro, è necessario installare un unico nuovo tastatore O4TT sul Tracer Tower al posto di U102TT e U103TT. Le istruzioni necessarie sono incluse nella confezione del morsetto opzionale R30 (D746897ZB).

● Triax Pro: tutti i sistemi serratura utilizzabili con il morsetto standard R29-01J-02J sono stati implementati.

● Triax-e.code e Triax 2: la memoria interna di queste duplicatrici è completa. Con questo aggiornamento, sono stati implementati tutti i sistemi serratura già disponibili nelle duplicatrici Quattrocode, Triax Quattro e Triax Pro. Sia questi sistemi che i nuovi che Silca svilupperà saranno inseriti **solo** nel Silca Key Programs e non a bordo macchina. Quindi per utilizzare i nuovi sistemi con le duplicatrici Triax-e.code e Triax 2 è necessario avere il Silca Key Programs.

SILCA TRIAX - QUATTROCODE PROGRAM

Data Update with 28 new series

SKP Vers. 21.2.x.xx

VORSICHT:

- Für die Fräsmaschinen Quattrocode und Triax-e.code wurde die **neue Spannbacke R30** entwickelt, die die abnehmbaren Backen von Triax Pro und Futura verwenden kann. Nur für die neuen von Silca entwickelten Schließsysteme mit neuen Backen muss die Spannbacke R30 verwendet werden. Alle existierenden Extras für Quattrocode und Triax-e.code werden nicht durch abnehmbare Backen für die Spannbacke R30 ersetzt.
- Für die Fräsmaschine Triax Quattro wurde die neue Spannbacke R30 entwickelt, die die abnehmbaren Backen von Triax Pro verwenden kann. Alle in Triax Pro verwendeten abnehmbaren Backen können auch mit der Spannbacke R30 auf der Maschine Triax Quattro verwendet werden.
- Zur Benutzung der Spannbacke R30 mit den Fräsmaschinen Triax-e.code, Triax 2 und Triax Quattro, muss ein einziger neuer Taster 04TT am Tracer Tower an Stelle der Taster U102TT und U103TT eingebaut werden. Die entsprechende Anleitung ist in der Packung der Extra-Spannbacke R30 (D746897ZB) enthalten.
- Triax Pro: Alle mit der Standard-Spannbacke R29-01J-02J verwendbaren Schließsysteme wurden implementiert.
- Triax-e.code und Triax 2: Der maschineninterne Speicher dieser Fräsmaschinen ist komplett ausgeschöpft. Mit diesem Update wurden alle in den Fräsmaschinen Quattrocode, Triax Quattro und Triax Pro bereits schon verfügbaren Schließsysteme installiert. Sowohl diese Systeme als auch die neuen, die Silca entwickeln wird, werden **nur** in Silca Key Programm aufgenommen und nicht in die Maschine gespeichert. Für die Benutzung der neuen Systeme mit den Fräsmaschinen Triax-e.code und Triax 2 müssen Sie zwingend das Silca Key Programm haben.

ATTENTION:

- Pour les machines à reproduire les clés Quattrocode et Triax-e.code, on a introduit un **nouvel étai R30** qui peut accueillir les mâchoires amovibles de Triax Pro et Futura. L'étai R30 ne sera indispensable que sur les nouveaux systèmes. Pour les nouveaux systèmes serrure développés par Silca avec de nouvelles mâchoires, il faudra utiliser l'étai R30. Toutes les options existant pour Quattrocode et Triax-e.code ne seront par remplacées par des mâchoires amovibles pour l'étai R30.
- Pour la machine à reproduire les clés Triax Quattro on a introduit le nouvel étai R30 pouvant accueillir les mâchoires amovibles de Triax Pro. Tous les systèmes serrure développés sur Triax Pro sur les mâchoires amovibles sont utilisables avec l'étai R30 aussi sur la machine Triax Quattro.
- Pour utiliser l'étai R30 avec les machines à reproduire les clés Triax-e.code, Triax 2 et Triax Quattro, il faut installer un seul nouveau palpeur 04TT sur Tracer Tower au lieu des palpeurs U102TT et U103TT. Les instructions nécessaires sont incluses dans la boîte de l'étai optionnel R30 (D746897ZB).
- Triax Pro: tous les systèmes serrure utilisables avec l'étai standard R29-01J-02J ont été mis en oeuvre.
- Triax-e.code et Triax 2: la mémoire interne de ces machines à reproduire les clés est complète. Avec cette mise à jour, on a mis en oeuvre tous les systèmes serrure déjà disponibles pour les machines à reproduire les clés Quattrocode, Triax Quattro et Triax Pro. Ces systèmes, ainsi que les nouveaux systèmes que Silca développera, ne seront insérés **que dans** Silca Key Programs et non pas à bord de la machine, donc, pour exploiter les nouveaux systèmes avec les machines à reproduire les clés Triax-e.code et Triax 2 il faudra avoir Silca Key Programs.

ATENCIÓN:

- Para las duplicadoras Quattrocode y Triax-e.code se ha introducido la **nueva mordaza R30**, que puede alojar las quijadas amovibles de Triax Pro y Futura. Solamente para los nuevos sistemas de cerradura, desarrollados por Silca con nuevas quijadas, habrá que usar la mordaza R30. Todos los opcionales, existentes para Quattrocode y Triax-e.code, no pueden sustituirse por quijadas amovibles para la mordaza R30.
- Para la duplicadora Triax Quattro se ha introducido la nueva mordaza R30, que puede alojar las quijadas amovibles de Triax Pro. Todos los sistemas de cerradura, desarrollados en Triax Pro en las quijadas amovibles, se usan también con la mordaza R30 en la máquina Triax Quattro.
- Para usar la mordaza R30 con las duplicadoras Triax-e.code, Triax 2 y Triax Quattro, se ha de instalar un único nuevo palpador 04TT en el Tracer Tower en lugar de los U102TT y U103TT. Las instrucciones necesarias están incluidas en la caja de la mordaza opcional R30 (D746897ZB).
- Triax Pro: todos los sistemas de cerradura, que usar con la mordaza estándar R29-01J-02J, se han implementado.
- Triax-e.code y Triax 2: la memoria interna de estas duplicadoras está completa. Con esta actualización, se han implementado todos los sistemas de cerradura disponibles anteriormente en las duplicadoras Quattrocode, Triax Quattro y Triax Pro. Estos sistemas y los nuevos, que Silca desarrollará, se introducirán **solamente** en el Silca Key Programs y no a bordo de la máquina. Por consiguiente, para usar los nuevos sistemas con las duplicadoras Triax-e.code y Triax 2 se ha de poseer el Silca Key Programs.

ATENÇÃO:

- Para as máquinas duplicadoras Quattrocode e Triax-e.code foi introduzido o **novo mordente R30** que pode alojar as garras amovíveis de Triax Pro e Futura. Só para os novos sistemas fechadura desenvolvidos pela Silca com novas garras será necessário utilizar o mordente R30. Todos os opcionais existentes para Quattrocode e Triax-e.code não serão substituídos por garras amovíveis para o mordente R30.
- Para a máquina duplicadora Triax Quattro foi introduzido o novo mordente R30 que pode alojar as garras amovíveis de Triax Pro. Todos os sistemas fechadura desenvolvidos em Triax Pro nas garras amovíveis também podem ser utilizados com o mordente R30 na máquina Triax Quattro.
- Para utilizar o mordente R30 com as máquinas duplicadoras Triax-e.-code, Triax 2 e Triax Quattro, é necessário instalar um único novo palpador 04TT no Tracer Tower em lugar dos U102TT e U103TT. As instruções necessárias estão contidas na embalagem do mordente opcional R30 (D746897ZB).
- Triax Pro: todos os sistemas fechadura utilizáveis com o mordente standard R29-01J-02J foram implementados.
- Triax-e.code e Triax 2: a memória interna destas máquinas duplicadoras é completa. Com esta actualização, foram implementados todos os sistemas fechadura já disponíveis nas máquinas duplicadoras Quattrocode, Triax Quattro e Triax Pro. Seja estes sistemas bem como os novos que a Silca irá desenvolver serão inseridos **somente** no Silca Key Programs e não a bordo máquina. Portanto, para utilizar os novos sistemas com as máquinas duplicadoras ax-e.code e Triax 2 é necessário ter o Silca Key Programs.

SILCA CODE PROGRAM

Data Update with 4 new cutting cards

SKP Vers. 21.2.x.xx



UC199



Unocode 299/399

Data update with 4 new cutting cards / Aggiornamento dati con 4 nuove schede / Datenaktualisierung mit 4 neuen Karten / Mise à jour des données avec 4 nouvelles fiches / Actualización datos con 4 fichas nuevas / Atualização de dados com 4 fichas novas.

New items include / Tra le novità / Unter den Neuheiten / Parmi les nouveautés / Entre las novedades / Entre as novidades:

- Huwil®
- Renault®
- M&C® (Matrix)
- Schlage® (AUB System)



Unocode 399 Evo



Unocode Pro



Update the software on / Aggiornare il software di / Aktualisierung der Software von / Mettre à jour le logiciel de / Actualizar el software de / Atualizar o software de: UC199, Unocode 299, Unocode 399, Unocode 399 Evo, Unocode Pro.

® are registered trademarks. / sono marchi registrati. / sind eingetragene Marken. / sont des marques déposées. / son marcas registradas. / são marcas registradas.



To duplicate is easy with
SILCA KEY PROGRAMS

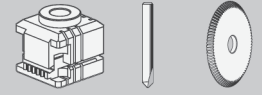

FOR:
PER:



TRIAX QUATTRO

> SW 1.4.062



TRIAX-e.code

> SW 5.4.093

> SKP 21.2.0.54



QUATTROCODE

> SKP 21.2.0.54

OPTIONAL

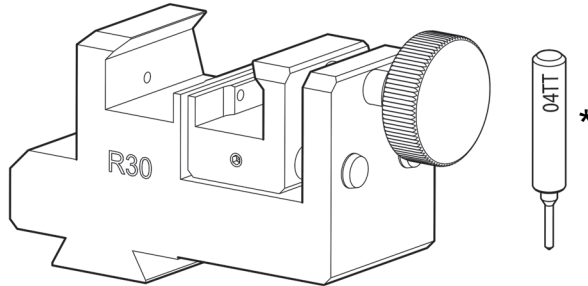

D746897ZB

R30 clamp + 04TT tracer
Morsetto R30 + tastatore 04TT
Spannbacke R30 + Taster 04TT
Etau R30 + palpeur 04TT
Mordaza R30 + palpador 04TT
Mordente R30 + palpador 04TT

R30

- EN** “Universal” clamp for removable jaws, only for new lock systems that require new hardware.
* The 04TT tracer IS NOT to be used with the QUATTROCODE key-cutting machine.
- IT** Base morsetto “universale” per ganasce rimovibili, solo per nuovi sistemi serratura che richiedono un nuovo hardware.
* Il tastatore 04TT NON va utilizzato con la duplicatrice QUATTROCODE.
- DE** Universalspannbackenbasis für abnehmbare Backen, nur für neue Schließsysteme, die eine neue Hardware brauchen.
* Der Taster 04TT darf NICHT mit der Fräsmaschine QUATTROCODE benutzt werden.
- FR** Base étau “universal” pour mâchoires amovibles destinée exclusivement aux nouveaux systèmes serrure exigeant un nouvel hardware.
* NE PAS utiliser le palpeur 04TT avec la machine QUATTROCODE.
- ES** Base mordaza “universal” para quijadas amovibles, solamente para los nuevos sistemas de cerradura que demandan un hardware nuevo.
* El palpador 04TT NO se ha de usar con la duplicadora QUATTROCODE.
- PT** Base mordente “universal” para garras amovíveis, só para novos sistemas fechadura que necessitam de um novo hardware.
* O palpador 04TT NÃO deve ser utilizado com a máquina duplicadora QUATTROCODE.

FOR:
PER:

SECUREMME (IT)

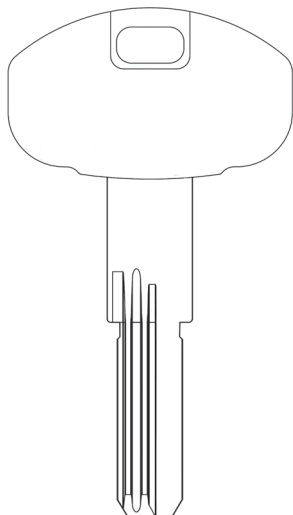

EVO K22 (11 pin)
EVO K64 (10 pin) (11pin)

System protected by a password issued by Silca on receipt of authorization.

Sistema protetto da password rilasciata da Silca a fronte di autorizzazione.

Passwort geschütztes System - Freigabe des Herstellers erforderlich.

Système protégé par un password qui est émis par Silca sur autorisation.

Sistema protegido por password que expide Silca contra autorización.

Sistema protegido por uma password emitida por Silca contra a autorização.



TRIAX PRO
>SW 3.0.024

TRIAX QUATTRO
>SW 1.4.062



TRIAX-e.code
>SW 5.4.093
>SKP 21.2.0.54



QUATTROCODE
>SKP 21.2.0.54

OPTIONAL D743341ZB

• CODE
◊ COPY
13J Jaw
Ganascia 13J
13J Backe
Mâchoire 13J
Quijada 13J
Garra 13J

STANDARD D943254ZR

• CODE
◊ COPY
02J Jaw
Ganascia 02J
02J Backe
Mâchoire 02J
Quijada 02J
Garra 02J

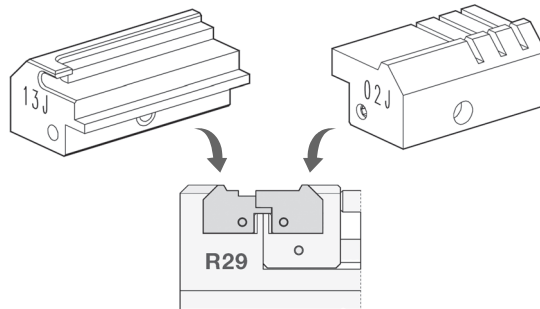

OPTIONAL



D747823ZB

Cutter W173
Fresa W173
Fräser W173
Fraise W173
Fresa W173
Fresa W173



OPTIONAL D743341ZB

• CODE
◊ COPY
13J Jaw
Ganascia 13J
13J Backe
Mâchoire 13J
Quijada 13J
Garra 13J

OPTIONAL D943254ZR

• CODE
◊ COPY
02J Jaw
Ganascia 02J
02J Backe
Mâchoire 02J
Quijada 02J
Garra 02J

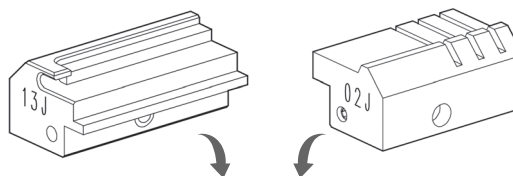

OPTIONAL

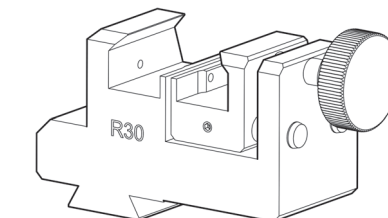

D746897ZB

R30 clamp + 04TT tracer
Morsetto R30 + tastatore 04TT
Spannbacke R30 + Taster 04TT
Etau R30 + palpeur 04TT
Mordaza R30 + palpador 04TT
Mordente R30 + palpador 04TT

OPTIONAL



D747823ZB

Cutter W173
Fresa W173
Fräser W173
Fraise W173
Fresa W173
Fresa W173



- * The 04TT tracer IS NOT to be used with the QUATTROCODE key-cutting machine.
- * Il tastatore 04TT NON va utilizzato con la duplicatrice QUATTROCODE.
- * Der Taster 04TT darf NICHT mit der Fräsmaschine QUATTROCODE benutzt werden.
- * NE PAS utiliser le palpeur 04TT avec la machine QUATTROCODE.
- * El palpador 04TT NO se ha de usar con la duplicadora QUATTROCODE.
- * O palpador 04TT NÃO deve ser utilizado com a máquina duplicadora QUATTROCODE.



*Silca wishes you
joyful Winter Holidays and
a Happy New Year*

