



Month
of

JANUARY 2015

Silca News Bulletin

No. 01/15



ALL THE NEW KEYS, AUTOMOTIVE SOLUTIONS, KEY CUTTING MACHINES, SOFTWARE UPDATES AND MUCH MORE

Contents

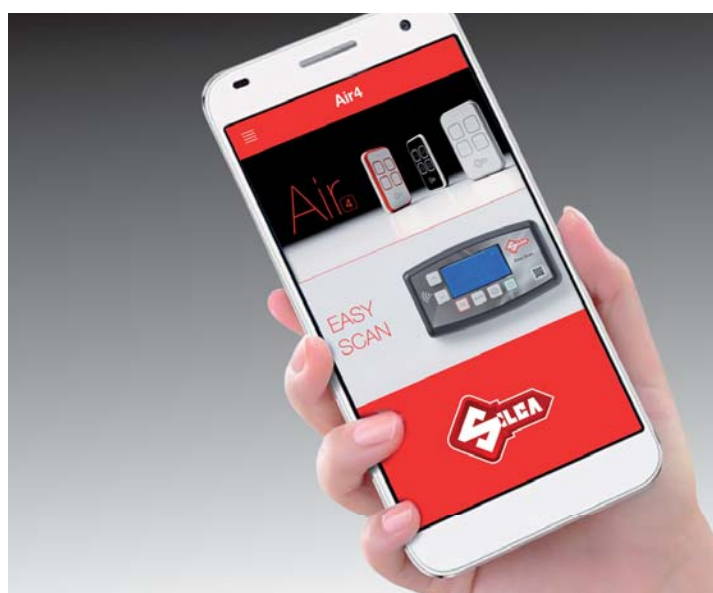
New Silca Keys	1
Futura One	2, 3
Software Futura Upgrade	4
VKF Pro on MySilca App	5
MySilca App	6, 7

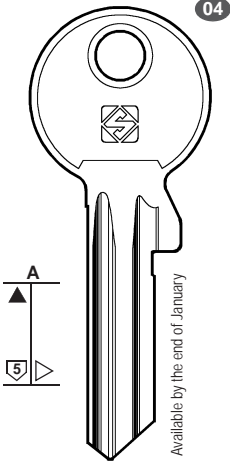

New keys / Chiavi Nuove / Neue Schlüssel / Nouvelles Clés
Llaves Nuevas / Chaves Nuevas

FOR: PER:	BRISANT	FOR / PER BRISANT (GB)	
 <p>Available by the end of January</p>		<p>01</p> <p>COMMERCIAL GROUP GRUPPO COMMERCIALE PREISEGRUPPE GROUPE COMMERCIAL GRUPO COMMERCIAL GRUPO COMMERCIAL</p> <p>www.silca.biz</p>	

ELECTRONIC KEY CATALOGUE

Discover Silca keys range visiting ekc.silca.biz // Scopri tutta la gamma chiavi Silca collegandoti a ekc.silca.biz // Entdecken sie die gesamte Silca Schlüsselpalette auf ekc.silca.biz // Découvrez notre gamme de clés Silca directement sur ekc.silca.biz // Descubra la gama completa de las llaves Silca visitando ekc.silca.biz // Descubra toda a gama de chaves através de ekc.silca.biz



**Register now
on ekc.silca.biz
It's free!**

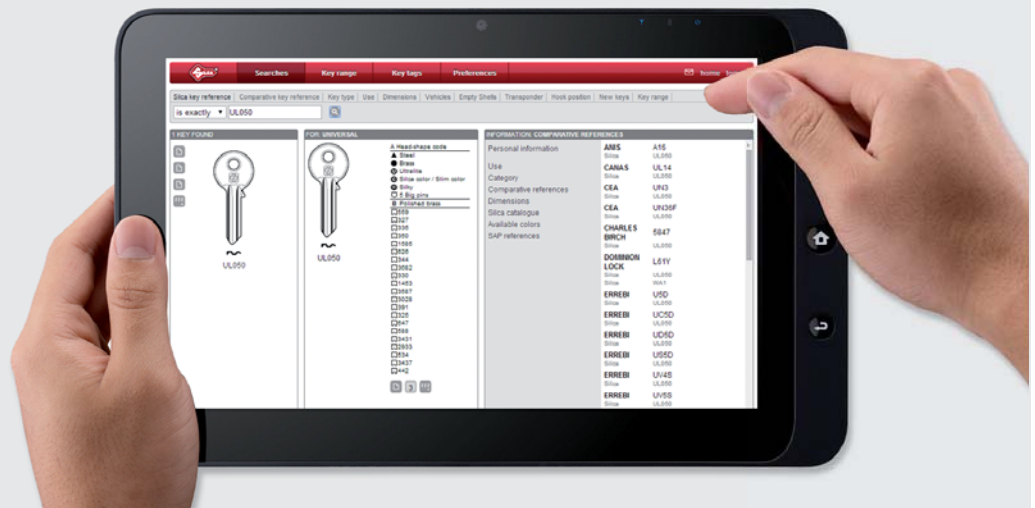



Futura One

After the unparalleled success of Futura, Silca is pleased to introduce Futura One, the new, tablet-integrated electronic key cutting machine for laser and dimple keys.

TYPES OF DUPLICABLE KEYS

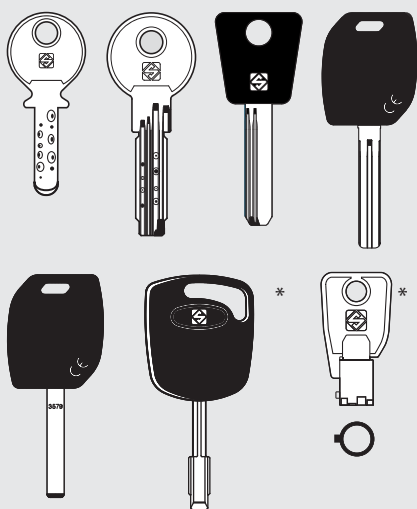

* In order to copy these keys, specific optional accessories are required. / Per duplicare queste tipologie di chiavi è necessario utilizzare gli adattatori opzionali specifici. / Um diese Schlüssel zu kopieren, müssen Sie spezifisches Zubehör verwenden. / Pour reproduire ces clés, il faut utiliser des accessoires optionnels spécifiques. / Para copiar estas llaves hay que utilizar los accesorios opcionales específicos. / Para copiar essas chaves você deve usar acessórios opcionais específicos.

🇬🇧 FUTURA ONE

Futura One is the new, ground-breaking electronic key cutting machine for laser and dimple keys. It features:

- // **Optimized single cutting station:** key decoding by electric contact, clamp with interchangeable jaws, automatic calibration.
- // **Tablet-integrated** solution to keep Silca software database and functions at hand.
- // Entirely **automated movements** on 3 axes and step-by-step guided key cutting operations.
- // Innovative **led lighting** that changes color according to the machine's status.
- // **Compact dimensions**, suitable for small-sized shops and van transportation.
- // Comfortable and efficient working area with integrated swarf tray, accessories area and tool holder.
- // Select components, high-quality materials and cutting-edge technologies guaranteed by Silca.

🇮🇹 FUTURA ONE

Futura One è la nuova, rivoluzionaria duplicatrice elettronica per chiavi a cifra-punzonata e laser. È caratterizzata da:

- // **Stazione di taglio ottimizzata:** decodifica chiavi tramite contatto elettrico, morsetto unico con ganasce intercambiabili, calibrazione automatica.
- // Soluzione con **tablet integrato** per avere il database e le funzioni dei software Silca sempre a portata di mano.
- // **Movimenti automatici** lungo i 3 assi e operazioni di taglio interamente guidate.
- // Innovativa **illuminazione a led** che cambia colore secondo lo stato della macchina.
- // **Dimensioni compatte**, adatta a negozi con spazi ridotti e al trasporto su furgoni.
- // Spazio di lavoro confortevole ed efficiente con area accessori, vassoio raccogli trucioli e porta utensili incorporati.
- // Componenti selezionati, materiali di prima qualità e tecnologie di ultima generazione garantiti da Silca.

> More info on all Silca websites

Futura One



FUTURA ONE

Futura One ist die neue, bahnbrechende elektronische Schlüsselfräsmaschine für Bahnen- und Bohrmuldenschlüssel. Sie ist durch folgendes gekennzeichnet:

- // **Optimierter Fräsprozess:** Dekodierung der Schlüssel durch einen elektrischen Kontakt, Spannlösung mit austauschbaren Backen, automatische Kalibrierung.
- // Dank der **Tablet-integrierten** Lösung stehen Ihnen die Datenbank und die Funktionen des Silca-Software stets zur Verfügung.
- // **Vollautomatische Bewegung** auf drei Achsen und Schritt für Schritt geführte Schlüsselfräsprozesse.
- // **Innovative LED-Beleuchtung**, die ihre Farbe dem Maschinenstatus entsprechend ändert.
- // **Kompakte Abmessungen**, für kleine Geschäfte und dem mobilen Einsatz geeignet.
- // Komfortabler und effizienter Arbeitsbereich mit integriertem Spänebehälter, Zubehörbereich und Werkzeughalter.
- // Ausgewählte Komponenten, qualitativ hochwertige Materialien und modernste Technologie, die Silca garantiert.

FUTURA ONE

Futura One es la nueva y revolucionaria duplicadora electrónica para llaves de regata y de seguridad. Se caracteriza por:

- // **Proceso de corte optimizado:** decodificación de las llaves por contacto eléctrico, mordaza con solución de quijadas intercambiables, calibración automática.
- // **Tableta integrada** para que la base de datos y las funciones de los programas software de Silca estén siempre a mano.
- // **Movimientos totalmente automatizados** en 3 ejes y operaciones duplicadoras de llaves guiadas paso a paso.
- // **Iluminación innovadora de lámparas led** que cambian de color según el estado de la máquina.
- // **Dimensiones compactas**, ideal para tiendas pequeñas y transporte en furgoneta.
- // Área de trabajo cómoda y eficaz con colector de virutas integrado, área de accesorios y portaherramientas.
- // Componentes selectos, materiales de alta calidad y aplicación de tecnologías avanzadas, todo con la garantía Silca.

FUTURA ONE

Futura One est la machine électronique à tailler les clés novatrice pour les clés laser et à points. Elle est caractérisée par:

- // **Processus de taillage optimisé:** décodage des clés par contact, électrique, étau avec une solution de mâchoires interchangeables, étalonnage automatique.
- // **Solution intégrée dans une tablette** pour garder les fonctions et la base de données du logiciel Silca.
- // **Mouvements entièrement automatisés** sur 3 axes et opérations de reproduction de clé guidées étape par étape.
- // **Eclairage led innovant** qui change de couleur en fonction du statut de la machine.
- // **Dimensions compactes**, adaptées aux boutiques de petite taille et au transport par fourgon.
- // Zone de travail confortable et efficace avec tiroir à copeaux intégré, espace de stockage des accessoires et porte-outils.
- // Composants de premier ordre, matériaux de haute qualité et technologies de pointe appliquées garantis par Silca.

FUTURA ONE

A Futura One é a inovadora máquina duplicadora eletrônica para chaves laser e de pontos. É caracterizada por:

- // **Processo de corte otimizado:** decodificação das chaves por contato elétrico, solução de mordentes com garras intercambiáveis, calibração automática.
- // **Solução com tablet integrado** para manter o banco de dados e as funções do programa software de Silca à mão.
- // **Movimentos totalmente automatizados** nos 3 eixos e operações de corte de chave guiadas passo a passo.
- // **Iluminação inovadora por led** que muda de cor de acordo com o estágio da máquina.
- // **Dimensões compactas** adequadas para instalações de pequeno porte e transporte por van.
- // Área de trabalho confortável e eficiente com bandeja integrada para as aparas, área de acessórios e recipiente para ferramentas.
- // Componentes selecionados, materiais de alta qualidade e tecnologias de ponta garantidos pela Silca.

> [More info on all Silca websites](#)

NEW

FUTURA PROGRAMS - UPDATES

Futura Version 2.6.0



Futura

FUTURA NEW SERIES

- Abus® (System V14-XY14-Y14 - Abus® Bravus 1000-2000-3000-4000)
- Ankerslot® (Infinity/Multi)
- Assa®_NEP (Neptun)
- Assa®_TRI (Triton 5900 - P600)
- Atra®/Dierre® (Atra® New Power (7W-2P) - Padronale)
- Ces® (Ces® PSM-UDM)
- Cisa®/Abus® (SP-TSP)
- Dom® (Dom®-Sigma - System RN (5P/6P))
- Euro Locks® (Euro Locks® MK U (2T - 10W))
- Gege® (APN-ESP-AP-CNS - pExtra-ANS-2-3-4)
- Gera® (Gera® 2000 Plus)
- GTV® (Standard GTV®)
- Iseo® (Iseo® KLE8R (5+5))
- Kaba® (Kaba® maTriX (K59))
- Keso® (Keso® 1000/Lips (3A))
- Magnum® (Magnum® Superior/Superior+)
- Mauer® (Mauer® DT-1)
- MLS®/Mauer® (Mauer® ML+ (5+5))
- Pfaffenhain® (Pfaffenhain® Wavy line Pro - Pfaffenhain® KV14 - XV14 - Pfaffenhain® Integral 14)
- Ruko® (Merkur 401)
- Vachette® (Radial)
- Wilka® (Carat-P1-PR100-P1)
- Winkhaus® (AZ/RPE/RPS/VS/VS6/Xpert - TEC RPS/RPE)

FUTURA NEW FUNCTIONS



- If Futura is not connected to internet, it is now possible to download the Futura Software update **into the tablet connected to internet** and then upgrade the machine from the tablet.
- If Futura is not connected to internet, it is now possible to download the software upgrade **into the PC via Silca Remote Service (SRS)** and then use a USB PEN to upload the upgrade to the machine.
- If requested, **register the machine to Silca Web**, in order to join the 6 months Free Subscription.

FUTURA REMINDER



- **Remember** to update the Silca.apk and SilcaKeyboard.apk after installing the Software update (see the on board Instructions Manual - Ch. 6.2 APP UPDATE (APK)).
- With the new **MySilca App** from Silca, you can keep the entire expertise and experience of your Key Partner at hand anytime anywhere.

Check out the **"Futura" page** on the Silca site to know more.
 Consulta il sito Silca alla **pagina "Futura"** per saperne di più.
 Sehen Sie die **Seite "Futura"** auf Silca Website, um weitere Informationen zu finden.
 Consultez la **page "Futura"** sur notre site Silca pour en savoir plus.
 Visite la **página "Futura"** en el sitio Silca para más informaciones.
 Consulte a **página "Futura"** no site Silca para saber mais.

> [More info on all Silca websites](#)

Find the Silca key for your vehicle

- 1 Choose your vehicle category
Category: ▾
- 2 Choose your vehicle brand
Brand: ▾
- 3 Choose your vehicle model
Model: ▾
- 4 Choose your vehicle year of production
Year: ▾

New Vehicle Key Finder PRO

Available exclusively on MySilca App



 With the new MySilca app you will be able to access the PRO version of the Vehicle Key Finder, the smart tool for rapidly identifying the key, transponder, Silca device and key cutting machine to use to duplicate any vehicle key by selecting make, model and year of production.

Duplicating automotive keys has never been easier!

 Con la nuova app MySilca potrai accedere alla versione PRO del Vehicle Key Finder, lo strumento che ti permetterà di individuare con immediatezza quale chiave, transponder, macchina duplicatrice e dispositivo Silca utilizzare per duplicare una qualsiasi chiave veicolo a partire da marca, modello e anno di produzione.

La duplicazione delle chiavi automotive non è mai stata così facile!

 Mit der neuen App MySilca können Sie auf die Version PRO von Vehicle Key Finder zugreifen. Das Mittel, das sofort: Schlüssel, Transponder, Maschine und Silca Vorrichtung zu identifizieren ermöglicht, um jeder Fahrzeugschlüssel aufgrund Marke, Modell und Baujahr kopieren zu können.

Das Kopieren von Automotive Schlüssel war noch nie so einfach!

 Avec la nouvelle application MySilca, vous pourrez accéder à la version PRO du Vehicle Key Finder, un programme qui vous permettra de comprendre immédiatement la clé, le transpondeur, la machine et/ou le dispositif Silca qui vous sera nécessaire pour reproduire n'importe quelle clé de véhicule, simplement à partir de la marque, du modèle et de l'année de production.

La duplication de clés automobiles n'a jamais été aussi facile!

 Con la nueva app MySilca podrá acceder a la versión PRO del Vehicle Key Finder, la herramienta que le permitirá identificar inmediatamente qué llave, transponder, máquina duplicadora y dispositivo Silca utilizar para duplicar cualquier llave vehículo seleccionando marca, modelo y año de producción.

¡La duplicación de llaves automotive nunca fue tan fácil!

 Com a nova app MySilca você pode acessar a versão PRO do Vehicle Key Finder, a ferramenta que lhe permitirá identificar imediatamente qual chave, transponder, máquina duplicadora e dispositivo Silca utilizar para duplicar qualquer chave para veículo a partir da marca, modelo e ano de produção.

A duplicação de chaves de automóvel nunca foi tão fácil!

> See also ekc.silca.biz/car-keys

MySilca App, Your World at a Fingertip



MySilca App - Rate it or leave a comment

Download MySilca from Google Play or App Store and install this exclusive app dedicated to the key cutting business directly on your smartphone. And afterwards rate it or leave a comment to let us know if you liked it or if you feel like there are contents to improve. Your feedback matters.

Stay tuned: many new features coming up next month on MySilca.

Scarica MySilca da Google Play o App Store e installa questa esclusiva applicazione dedicata al mondo della duplicazione chiave direttamente sul tuo smartphone. Ricordati di votare e scrivere una recensione per farci sapere se l'applicazione ti è piaciuta o se ritieni ci siano dei contenuti da migliorare. Il tuo feedback è importante.

Non perdere le molte novità in arrivo dal prossimo mese su MySilca.

Laden Sie MySilca von Google Play o App Store herunter und installieren Sie diese exklusive App., die der Schlüsselduplikation gewidmet ist, über Ihren Smartphone.

Bitte, denken Sie für diese App zu stimmen und schreiben Sie Ihre Bewertung um uns wissen zu lassen, ob die App passt, oder ob die Inhalte noch verbessert können werden. Ihres Feedback ist wichtig.

Verpassen Sie nicht die vielen Neuheiten ab kommendem Monat auf MySilca.

Téléchargez MySilca de Google Play ou App Store et installez cette application exclusive spécifique au monde della duplication des clés, directement sur votre smartphone. N'oubliez pas de voter et donner votre évaluation pour nous faire savoir si cette application vous a plu ou si vous retenez nécessaire que ses contenus soient améliorés.

Ne perdez pas les nombreuses nouveautés prévues à partir du mois prochain sur MySilca.

Descargue MySilca de Google Play o App Store e instale esta aplicación exclusiva dedicada al mundo de la duplicación de llaves en su smartphone. Y además envíenos sus comentarios para decimos si la aplicación le gusta o si usted cree que haya contenidos que se pueden mejorar.

Su opinión es importante.

No pierda las novedades que vendrán desde el próximo mes de MySilca.

Baixe MySilca de Google Play ou App Store e instale esta aplicação dedicada exclusivamente ao mundo da duplicação das chaves diretamente no seu smartphone. Lembre-se de avaliar e escrever um comentário para que possamos saber se o aplicativo você gostou ou se você acredita que o conteúdo pode ser melhorado. A sua opinião é importante.

Não perca as muitas novidades que vêm no próximo mês em MySilca.

Rate it or leave a comment

★★★★★

Recensioni **4,7**

★ 5	25
★ 4	3
★ 3	3
★ 2	0
★ 1	0

Totale: 31

Ulteriori informazioni

Aggiornata
19 dicembre 2014

Dimensioni
30M

Installazioni
500-1.000

> More info on all Silca websites



MySilca App



Now available from **App Store**



Download MySilca App



[> More info on all Silca websites](#)



SILCA NEWS 02/15

ALL THE NEW KEYS, AUTOMOTIVE SOLUTIONS, KEY CUTTING MACHINES, SOFTWARE UPDATES AND MUCH MORE

Contents

New Keys	1
Fastbit	2
Fastbit II	3
Futura 1 st Birthday	4
Futura Software Update	5
Key Machine Optional Accessories	6
Silca Events in Europe	7





New keys / Chiavi Nuove / Neue Schlüssel / Nouvelles Clés / Llaves Nuevas / Chaves Nuevas

FOR: PER:	ANKERSLOT	BULLDOG	DOM	FOR / PER
	<p>AKR16R</p>	<p>BLG2</p>	<p>DM154 DM154R</p>	ANKERSLOT (NL) BULLDOG (GB) DOM (D) EVVA (A) GERA (D) SOBINCO (B)
FOR: PER:	EVVA	GERA	SOBINCO	
	<p>EV109X</p>	<p>GR15</p>	<p>SN5RDZ</p>	
				01 COMMERCIAL GROUP GRUPPO COMMERCIALE PREISEGRUPPE GROUPE COMMERCIAL GRUPO COMMERCIAL GRUPO COMERCIAL www.silca.biz

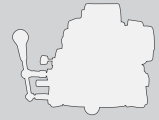

Fastbit

Precise, easy to use and ergonomic, Fastbit is the new mechanical key cutting machine for bit, double bit, pump and central stop keys.

TYPES OF DUPLICABLE KEYS

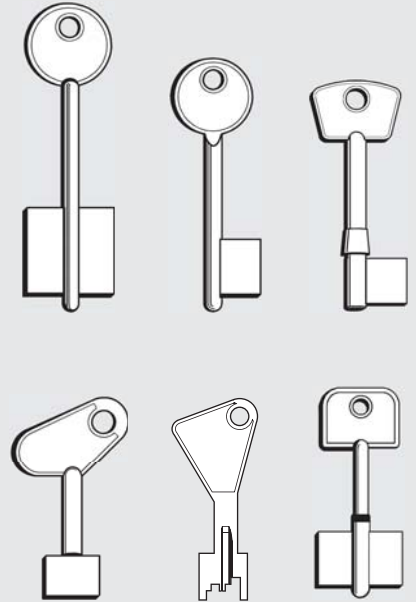

FASTBIT

Fastbit is the new mechanical key cutting machine for bit, double bit, pump and central stop keys.

With the dedicated optional accessories you can duplicate also keys with vertical cuts.

FASTBIT

Fastbit è la nuova duplicatrice meccanica per chiavi a mappa, doppia mappa, a pompa e con fermo centrale.

Con gli opportuni accessori opzionali puoi duplicare anche chiavi con tagli verticali.

FASTBIT

Fastbit ist die neue mechanische Schlüsselfräsmaschine für Bart-, Doppelbart-, Pumpenschlüssel und Schlüssel mit Halmanschlag.

Mit dem optionalen Zubehör kann man auch Schlüssel mit vertikalen Einschnitte kopieren.

FASTBIT

Fastbit est la nouvelle machine à tailler les clés pour les clés à panneton, à double panneton, à pompes et à butée centrale.

Avec les accessoires optionnels ad hoc vous pourrez reproduire aussi les clés avec ève.

FASTBIT

Fastbit es la nueva duplicadora mecánica para llaves de pala, doble pala, frontales y con tope central.

Con los accesorios opcionales puede duplicar también las llaves con cortes verticales.

FASTBIT

Fastbit é a nova duplicadora mecânica para chaves de palhetão, duplo palhetão, de bomba e com encosto central.

Com os acessórios opcionais é possível duplicar também as chaves com cortes verticais.

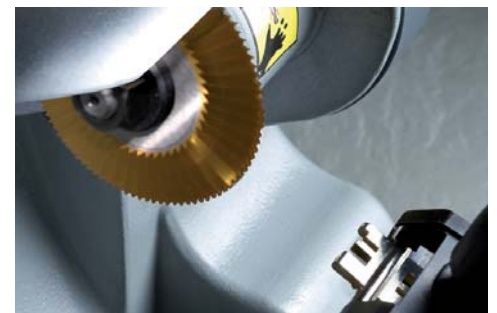

> More info on all Silca websites

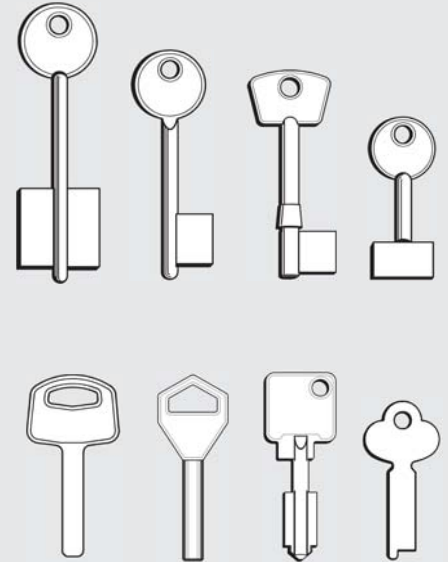
TYPES OF DUPLICABLE KEYS

Fastbit II

Reliable, user-friendly and compact, Fastbit II perfectly duplicates bit, double bit, pump, mail box, central stop and special keys.

🇬🇧 FASTBIT II

Fastbit II is the new mechanical key cutting machine for bit, double bit, pump, mail box, central stop and special keys (such as Abloy®, Abus®, Luma®, Ava Chubb®). With the dedicated optional accessories you can duplicate also keys with vertical cuts.

🇩🇪 FASTBIT II

Fastbit II ist die neue Schlüsselfräsmaschine für Bart-, Doppelbart-, Pumpen-, Briefkasten-, Spezialschlüssel (Abloy®, Abus®, Luma®, Ava Chubb®) und Schlüssel mit Halmanschlag in der Mitte. Mit dem optionalen Zubehör kann man auch Schlüssel mit vertikalen Einschnitte kopieren.

🇪🇸 FASTBIT II

Fastbit II es la nueva duplicadora mecánica para llaves de pala, doble pala, frontales, para casilleros postales, con tope central y llaves especiales (Abloy®, Abus®, Luma®, Ava Chubb®). Con los accesorios opcionales puede duplicar también las llaves con cortes verticales.

🇮🇹 FASTBIT II

Fastbit II è la nuova duplicatrice meccanica per chiavi a mappa, doppia mappa, a pompa, per casellari postali, con fermo centrale e chiavi speciali (Abloy®, Abus®, Luma®, Ava Chubb®). Con gli opportuni accessori opzionali puoi duplicare anche chiavi con tagli verticali.

🇫🇷 FASTBIT II

Fastbit II est la nouvelle machine à tailler les clés pour les clés à panneton, double panneton, à pompes, pour boîtes postales, à butée centrale et clés spéciales (Abloy®, Abus®, Luma®, Ava Chubb®). Avec les accessoires optionnels ad hoc vous pourrez reproduire aussi les clés avec ève.

🇵🇹 FASTBIT II

Fastbit II é a nova duplicadora mecânica para chavesde palhetão, duplo palhetão, de bomba, para caixas de correio, com encosto central e chaves especiais (Abloy®, Abus®, Luma®, Ava Chubb®). Com os acessórios opcionais é possível duplicar também as chaves com cortes verticais.

> [More info on all Silca websites](#)



THE FUTURE IS NOW

> Click here to discover more
on the Futura series



CELEBRATE WITH US 1 YEAR OF SUCCESS

Thousands of key cutters and locksmiths worldwide have already chosen FUTURA
What are you waiting for?

FESTEGGIA CON NOI 1 ANNO DI SUCCESSO

Migliaia di duplicatori e specialisti nel mondo hanno scelto FUTURA
E tu, che cosa aspetti?

FEIERN SIE MIT UNS 1 JAHR ERFOLG

Mehr als 1000 Schlüsseldienste und Sicherheitsfachgeschäfte haben sich bereits schon für die FUTURA entschieden
Worauf warten Sie?

FÊTEZ AVEC NOUS 1 ANNÉE DE SUCCÈS

Des milliers de serruriers et spécialistes dans le monde entier ont choisi FUTURA
Et vous, qu'attendez-vous?

CELEBRA CON NOSOTROS 1 AÑO DE ÉXITO

Miles de centros de duplicación y profesionales en todo el mundo ya han elegido FUTURA
¿Y tú que esperas para usarla?

VENHA CELEBRAR CONNOSCO 1 ANO DE SUCESSO

Milhares de serralheiros duplicadores de chaves a nível mundial, já escolheram a FUTURA
E você? Do que é que está à espera?

Futura Software Update

Vers. 2.7.1 db 1.20 – Silca App Vers. 1.14



FUTURA NEW SYSTEMS

Data update with 6 new series / Aggiornamento dati con 6 nuove serie / Datenaktualisierung mit 6 neuen Serien / Mise à jour des données avec 6 séries / Actualización datos con 6 nuevas series / Atualização dados com 6 novas séries

- Brisant® (6P)
- Gege® (pExtra Swe)
- Snc® (30/30)
- Cisa® (CS501)
- Metal® (x6s)
- Valeo® (2T-8W)

© Registered Trade Marks exclusive property of authorized manufacturers of locks and users. Said Trade Marks or Trade Names are nominated only for the purposes of information so that any lock for which our keys are made can be quickly identified.

FUTURA REMINDER

- After installing the Software update **Remember to also update the Silca.apk** [see the on board Instructions manual – Ch 6.2 APP UPDATE (APK)].

- With the new **MySilca App** from Silca, you can access all the expertise and experience of your Key Partner anytime, anywhere.



Futura Frequently Asked Questions

Can I use a different tablet with my Futura machine or must I only use the one that was supplied along with the Futura machine?

The tablet supplied along with the Futura machine has already been tested and registered to the Futura machine, therefore does not require any additional procedure other than to make sure that one first switches the Futura machine on, then its tablet.

Most other tablets can also be used with the Futura machine, but the display should be at least 10 inches and the operating system must be Android (minimum version required: 4.2). One must also download and install both the Silca Futura Application and the Silca Keyboard Application to it.

> [More FAQs on MySilca App](#)

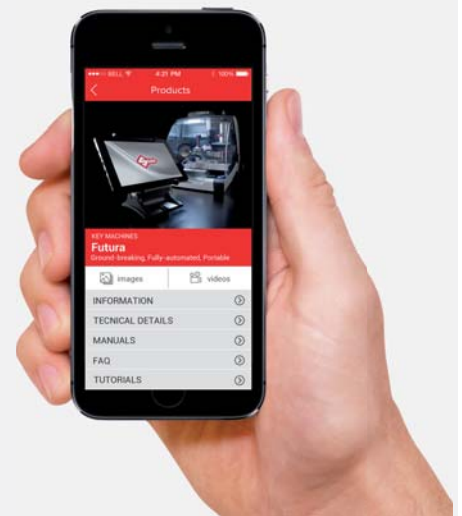

> [More info on all Silca websites](#)

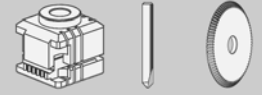
Accessories / Accessori / Zubehör / Accessoires / Accesorios / Acessórios

 FOR:
PER:

VIRO (I)

(Palladium)

System protected by a password issued by Silca on receipt of authorization.
 Sistema protetto da password rilasciata da Silca a fronte di autorizzazione.
 Sysyem geschützt durch von Silca geliefertes Password auf Genehmigung.
 Système protégé par un password qui est émis par Silca sur autorisation.
 Sistema protegido por password que expide Silca contra autorización.
 Sistema protegido por uma password emitida por Silca contra a autorização.



FUTURA

> SW Futura 2.8

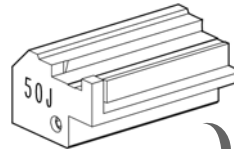

QUATTROCODE

**TRIAX QUATTRO
TRIAX-E.CODE**
OPTIONAL

D744560ZB

 50J Jaw
 Ganascia 50J
 50J Backe
 Mâchoire 50J
 Quijada 50J
 Garra 50J

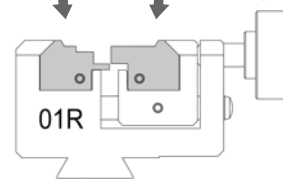
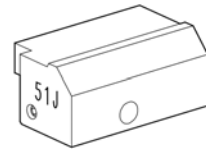
OPTIONAL

D744634ZB

 51J Jaw
 Ganascia 51J
 51J Backe
 Mâchoire 51J
 Quijada 51J
 Garra 51J

 Delivery time FEBRUARY 2015
 Disponibilit  FEBBRAIO 2015
 Lieferbar FEBRUAR 2015
 Disponibilit  FEVRIER 2015
 Disponibilidad FEBRERO 2015
 Disponibilidade FEVEREIRO 2015

OPTIONAL

D743673ZB

 Cutter 02D
 Fresa 02D
 Fr ser 02D
 Fraise 02D
 Fresa 02D
 Fresa 02D

OPTIONAL

**CARD 3859
SN 1554**
**CARD 3860
SN 1553**
D744557ZB

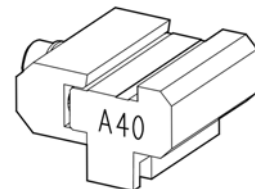
 Adapter A40
 Adattatore A40
 Adapter A40
 Adaptateur A40
 Adaptador A40
 Adaptador A40

OPTIONAL

D744569ZB

 Cutter W328 (carbide)
 Fresa W328 (metallo duro)
 Fr ser W328 (Hartmetall)
 Fraise W328 (au carbure)
 Fresa W328 (metal duro)
 Fresa W328 (metal duro)

 Starting from SKP Software version 20.5.0.54
 Dalla versione Software SKP 20.5.0.54
 Ab SKP Software Version 20.5.0.54
   partir du software SKP version 20.5.0.54
 Desde software SKP versi n 20.5.0.54
 A partir da vers o software SKP 20.5.0.54

 Delivery time FEBRUARY 2015
 Disponibilit  FEBBRAIO 2015
 Lieferbar FEBRUAR 2015
 Disponibilit  FEVRIER 2015
 Disponibilidad FEBRERO 2015
 Disponibilidade FEVEREIRO 2015



Tatiana Mura - Unifiled



A. Roncoroni - La sicurezza in testa / Safety on your head



Silvia Sama - Omibello / Belly burton

Silca Events in Europe

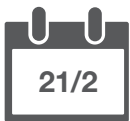

Artensile - Hardware Art Show
in La Spezia - CAMeC, Centre for
Modern and Contemporary Art
ITALY

Art meets Hardware

Silca supports Artensile, a photography competition created by Sabrina Canese and supported by the municipality of La Spezia and by CAMeC that aim to shed a new light on the mundane world of hardware goods. This year's theme is focusing on security devices, such as locks, keys and safes.

The winners of the competition will be announced on 21st February, while soon after Artensile Off will start: the best photos will be exhibited in several hardware shops all over the country.

> [More info on artensile.it](http://www.artensile.it)



Open House

in Böblingen - Motorworld Region
Stuttgart
GERMANY

Silca at the Motorworld

Silca GmbH hits the core of the German automotive industry with an open house at the Motorworld Region Stuttgart. Here, you will have the chance to test hands-on all of the latest Silca products, including Air4 remotes, Futura One, the electronic key cutting machines for laser and dimple keys, and the highly advanced range of vehicle keys and transponder devices.

Co-exhibitors Ankerslot, CES, Iseo, SimonsVoss, Tütemann, Volk and W&M will make the event even more interesting.

> [More info on www.motorworld.de](http://www.motorworld.de)



LockExpo - Locksmiths Exhibition

in Nottingham - East Midlands
Conference Centre, Booth B30
UNITED KINGDOM

The only UK's annual locksmith expo

Silca and its distributor in the UK are attending this year's edition of LockExpo, the annual exhibition of British locksmiths, key cutters and professionals within the security industry.

Come visit our stand and discover the latest keys, mechanical and electronic key cutting machines, vehicle keys cloning and programming devices and the wide range of automotive solutions to offer your customers an outstanding service and boost your revenue.

> [More info on lockexpo.co.uk](http://www.lockexpo.co.uk)



SILCA NEWS 03/15

ALL THE NEW KEYS, AUTOMOTIVE SOLUTIONS, KEY CUTTING MACHINES, SOFTWARE UPDATES AND MUCH MORE

Contents

New Keys	1
Empty Shells - New References	2
Vehicle Keys Guide	3, 4
Silca Key Programs and Futura Software Update	5-9
Optional Accessories for Key Cutting Machines	10-15





New Keys / Chiavi Nuove / Neue Schlüssel / Nouvelles Clés / Llaves Nuevas / Chaves Nuevas

FOR: PER:	HUF				
	 S83 Available in stock 1-6700	 S83 Available in stock 1-6700	 Available in stock	 Available in stock	 S83 Available in stock 1-6700
	HU116T	HU126T	HU127T	HU135T	HU138T

FOR / PER
HUF (D)
SUZUKI (J)
WITTE (D)

FOR: PER:	HUF	SUZUKI	WITTE
	 HCA Available in stock	 1512 288 1806 Available in stock	 Available in stock
	 S83 Available in stock 1-6700		
	 S83 Available in stock 1-6700	 51001-52500 3001-4500 18100-19299 19300-19617	
	HU141T	SZ16R	WT52T

01
 COMMERCIAL GROUP
 GRUPPO COMMERCIALE
 PREISEGRUPPE
 GROUPE COMMERCIAL
 GRUPO COMMERCIAL
 GRUPO COMERCIAL

www.silca.biz





SILCA EMPTY SHELLS - NEW REFERENCES

 Silca Empty Shells: **3 new keys references** to widen the existing range.

 Silca Empty Shells: **3 nouvelles références** clés qui complètent la gamme existante.

 Silca Empty Shells: **3 nuove referenze** chiavi che implementano la gamma già esistente.

 Silca Empty Shells: **3 nuevas referencias** llaves que completan la gama existente.

 Silca Empty Shells: **3 Schlüssel Referenzen** die das bestehende Angebot implementieren.

 Silca Empty Shells: **3 novas referências** chaves que implementam a gama existente.

Brand	References/Image	Specifications	Vehicle Models*																				
AUDI®	<p>HURSC2</p>  <p>Available in Stock</p>	2 Buttons	<table border="1"> <thead> <tr> <th>MODELS</th> <th>YEAR FROM</th> <th>YEAR TO</th> <th>TRANSPONDER TYPE</th> <th>TRP ID</th> </tr> </thead> <tbody> <tr> <td>A3</td> <td>1997</td> <td>2000</td> <td>MEG/CR</td> <td>48</td> </tr> <tr> <td>A4</td> <td>1997</td> <td>2001</td> <td>MEG/CR</td> <td>48</td> </tr> <tr> <td>A6</td> <td>1997</td> <td>2001</td> <td>MEG/CR</td> <td>48</td> </tr> </tbody> </table>	MODELS	YEAR FROM	YEAR TO	TRANSPONDER TYPE	TRP ID	A3	1997	2000	MEG/CR	48	A4	1997	2001	MEG/CR	48	A6	1997	2001	MEG/CR	48
MODELS	YEAR FROM	YEAR TO	TRANSPONDER TYPE	TRP ID																			
A3	1997	2000	MEG/CR	48																			
A4	1997	2001	MEG/CR	48																			
A6	1997	2001	MEG/CR	48																			
AUDI®	<p>HURSC8</p>  <p>Available in Stock</p>	3 Buttons	<table border="1"> <thead> <tr> <th>MODELS</th> <th>YEAR FROM</th> <th>YEAR TO</th> <th>TRANSPONDER TYPE</th> <th>TRP ID</th> </tr> </thead> <tbody> <tr> <td>A3</td> <td>1997</td> <td>2004</td> <td>MEG/CR</td> <td>48</td> </tr> <tr> <td>A4</td> <td>1997</td> <td>2004</td> <td>MEG/CR</td> <td>48</td> </tr> <tr> <td>A6</td> <td>1997</td> <td>2004</td> <td>MEG/CR</td> <td>48</td> </tr> </tbody> </table>	MODELS	YEAR FROM	YEAR TO	TRANSPONDER TYPE	TRP ID	A3	1997	2004	MEG/CR	48	A4	1997	2004	MEG/CR	48	A6	1997	2004	MEG/CR	48
MODELS	YEAR FROM	YEAR TO	TRANSPONDER TYPE	TRP ID																			
A3	1997	2004	MEG/CR	48																			
A4	1997	2004	MEG/CR	48																			
A6	1997	2004	MEG/CR	48																			
OPEL-VAUXHALL®	<p>HURSG8N</p>  <p>Available in Stock</p>	3 Buttons NO battery holder	<table border="1"> <thead> <tr> <th>MODELS</th> <th>YEAR FROM</th> <th>YEAR TO</th> <th>TRANSPONDER TYPE</th> <th>TRP ID</th> </tr> </thead> <tbody> <tr> <td>ASTRA</td> <td>1998</td> <td>2004</td> <td>PH/CR</td> <td>40</td> </tr> <tr> <td>OMEGA</td> <td>1998</td> <td>2004</td> <td>PH/CR</td> <td>40</td> </tr> </tbody> </table>	MODELS	YEAR FROM	YEAR TO	TRANSPONDER TYPE	TRP ID	ASTRA	1998	2004	PH/CR	40	OMEGA	1998	2004	PH/CR	40					
MODELS	YEAR FROM	YEAR TO	TRANSPONDER TYPE	TRP ID																			
ASTRA	1998	2004	PH/CR	40																			
OMEGA	1998	2004	PH/CR	40																			

















* The uses of the keys are purely indicative and may be subject to updates and revisions. / Gli utilizzi delle chiavi sono da considerarsi puramente indicativi e possono essere oggetto di aggiornamenti e revisioni. / Die Abbildung und technischen Daten der Schlüssel sind nicht bindend. Silca behält sich Änderungen am Produkt, die zur Verbesserung beitragen, vor. / Les usages des clés sont purement indicatifs; ils peuvent être mis à jour et revus. / Los usos de las llaves deben considerarse puramente indicativos y pueden ser objeto de actualizaciones y revisiones. / As utilizações das chaves devem ser consideradas puramente indicativas e podem ser objecto de actualizações e revisões.

® Registered Trademarks. / ® Marchi Registrati. / ® Eingetragene Marken. / ® Marques Déposées. / ® Marcas Registradas. / ® Marcas Registradas.



Car Keys Guide / Guida Chiavi Auto / Marktführer für Autoschlüssel / Guide Clés pour Voitures
 Guía Llaves para Coches / Guia Chaves para Carros

New Updates

1	2	2a	3	3a	3b	E1+E2		6	42+71	72	43 44a	12	15
						GTI COMPATIBLE		IGNITION 					
CAR MAKE MODEL	FROM	TO	SILCA REF.	SILCA REF.	SILCA REF.	COPY	GEN.	TRANSP. TYPE	FAST COPY PLUS RW4 PLUS FAST COPY / RW4	FAST COPY PLUS RW4 PLUS	FAST COPY RW4	STP	
													
For more info on the uses of car keys, refer to the Silca Electronic Key Catalogue: 													
AUDI®													
A3	1997	2000	HURSC2					MEG/CR	48				
A3	1997	2004	HURSC8					MEG/CR	48				
A4	1997	2001	HURSC2					MEG/CR	48				
A4	1997	2004	HURSC8					MEG/CR	48				
A6	1997	2001	HURSC2					MEG/CR	48				
A6	1997	2004	HURSC8					MEG/CR	48				
BMW®													
VARIOUS MODELS			HU127										
CITROËN®													
VARIOUS MODELS			HU141T										
HYUNDAI®													
VARIOUS MODELS			HU135T										
MERCEDES®													
VARIOUS MODELS			HU126T										
VARIOUS MODELS			HU144T										
VARIOUS MODELS			HU138T										
VARIOUS MODELS			HU116T										
VARIOUS MODELS			HU148T										
OPEL-VAUXHALL®													
ASTRA	1998	2004	HURSG8N					PH / CR	40	ID	ID		
OMEGA	1998	2004	HURSG8N					PH / CR	40	ID	ID		
PEUGEOT®													
VARIOUS MODELS			HU141T										
SUZUKI®													
VARIOUS MODELS			SZ16R										
VOLVO®													
VARIOUS MODELS			WT52T										

* The uses of the keys are purely indicative and may be subject to updates and revisions. / Gli utilizzi delle chiavi sono da considerarsi puramente indicativi e possono essere oggetto di aggiornamenti e revisioni. / Die Abbildung und technischen Daten der Schlüssel sind nicht bindend. Silca behält sich Änderungen am Produkt, die zur Verbesserung beitragen, vor. / Les usages des clés sont purement indicatifs; ils peuvent être mis à jour et revus. / Los usos de las llaves deben considerarse puramente indicativos y pueden ser objeto de actualizaciones y revisiones. / As utilizações das chaves devem ser consideradas puramente indicativas e podem ser objecto de actualizações e revisões.

® Registered Trademarks. / ® Marchi Registrati. / ® Eingetragene Marken. / ® Marques Déposées. / ® Marcas Registradas. / ® Marcas Registradas.



Truck Keys Guide / Guida Chiavi Camion / Marktführer für LKW Schlüssel Guide Clés pour Camions / Guía Llaves para Camiones / Guia Chaves para Camiões

New Updates

1	2	2a	3	3a	3b	E1+E2		6	42+71	72	43 44a	12	15
						GTI COMPATIBLE							
TRUCK MAKE MODEL	FROM	TO	SILCA REF.	SILCA REF.	SILCA REF.	COPY	GEN.	TRANSP. TYPE	FAST COPY PLUS RW4 PLUS FAST COPY / RW4	FAST COPY PLUS RW4 PLUS	FAST COPY RW4	STP	
For more info on the uses of truck keys, refer to the Silca Electronic Key Catalogue:													
MERCEDES®													
ACTROS			HU144T										

IMPORTANT NOTE:

See also the "Vehicle Guide Legend"
 Vedi anche la "Legenda Guida Veicoli"
 Siehe auch die "Fahrzeugschlüssel Erläuterung"
 Voir aussi la "Légende Guide Véhicules"
 Véase también la "Leyenda Guía para Vehículos"
 Veja também a "Legenda Guia para Veículos"

AUTOMOTIVE KEYS RANGE

Discover Silca range visiting www.silca.biz and ekc.silca.biz.

Scopri tutta la gamma chiavi collegandoti a www.silca.biz e ekc.silca.biz.

Entdecken sie die Schlüsselpalette auf unseren Websites www.silca.biz und ekc.silca.biz.

Découvrez la notre gamme de clés directement sur notre site www.silca.biz et ekc.silca.biz.

Descubra la gama completa de las llaves visitando www.silca.biz y ekc.silca.biz.

Descubra toda a gama de chaves através dos sítios www.silca.biz e ekc.silca.biz.



* The uses of the keys are purely indicative and may be subject to updates and revisions. / Gli utilizzi delle chiavi sono da considerarsi puramente indicativi e possono essere oggetto di aggiornamenti e revisioni. / Die Abbildung und technischen Daten der Schlüssel sind nicht bindend. Silca behält sich Änderungen am Produkt, die zur Verbesserung beitragen, vor. / Les usages des clés sont purement indicatifs; ils peuvent être mis à jour et revus. / Los usos de las llaves deben considerarse puramente indicativos y pueden ser objeto de actualizaciones y revisiones. / As utilizações das chaves devem ser consideradas puramente indicativas e podem ser objecto de actualizações e revisões.

© Registered Trademarks. / © Marchi Registrati. / © Eingetragene Marken. / © Marques Déposées. / © Marcas Registradas. / © Marcas Registradas.



Silca Key Programs

Update 1/2015 - SKP Vers. 20.6.x.xx

UPDATE 1/2015

New Silca Key Programs 1/2015 Update for all WEB and DVD subscribers. New items include:

- On CODEMAKER for flat keys a new "NORMAL EASY" cutting method can be used. This method can be selected on many data cards instead of the Normal, Flat or Laser method to reduce cutting vertices and make the key.
- Updated the comparative list.

MISE À JOUR 1/2015

Nouvelle mise à jour Silca Key Programs 1/2015 pour tous les abonnés WEB et DVD. Parmi les nouveautés:

- Sur CODEMAKER pour clés plates, il est possible d'utiliser une nouvelle taille appelée "NORMAL EASY". Cette méthode peut être sélectionnée dans plusieurs cartes en plus des méthodes Normal, Plate et Laser pour réduire les pointes de tailles et faire la clé.
- Mise à jour des comparatifs.

AGGIORNAMENTO 1/2015

Nuovo Aggiornamento Silca Key Programs 1/2015 per tutti gli abbonati WEB e DVD. Tra le novità:

- Nel CODEMAKER per chiavi piatte è possibile utilizzare un nuovo metodo di taglio denominato "NORMAL EASY", selezionabile in moltissime schede al posto del metodo Normale, Piano o Laser per ridurre i vertici di cifratura e rendere la chiave più scorrevole nel cilindro.
- Aggiornati i comparativi.

ACTUALIZACIÓN 1/2015

Nueva actualización Silca Key Programs 1/2015 para todos los abonados WEB y DVD. Entre las novedades:

- En el CODEMAKER para llaves planas es posible utilizar un nuevo método de corte llamado "NORMAL EASY", seleccionable en muchísimas fichas en lugar del método Normal, Plano o Láser para reducir los vértices de cifrado y para que la llave deslice mejor en el cilindro.
- Actualizado el comparativo.

AKTUALISIERUNG 1/2015

Neue Aktualisierung Silca Key Programs 1/2015 für alle WEB und DVD Abonnenten. Unter den Neuheiten:

- Im CODEMAKER für Flachschlüssel kann eine neue Frästart "NORMAL EASY" benutzt werden. Diese Methode kann auf vielen Datenkarten anstelle der Methode Normal, Flach oder Laser ausgewählt werden, damit die Frässpitzen verringert werden und die Schlüssel leichter in den Zylinder gleiten.
- Die Vergleichsliste wird aktualisiert.

ATUALIZAÇÃO 1/2015

Nova atualização Silca Key Programs 1/2015 para todos o assinantes WEB e DVD. Entre as novidades:

- No CODEMAKER para chaves planas é possível utilizar um novo método de corte chamado "NORMAL EASY", selecionável em muitas fichas em lugar do método Normal, Plano ou Laser para reduzir os vértices de corte e fazer com que a chave deslize melhor no cilindro.
- Atualizado os comparativos.

> [More info on all Silca websites](#)

SILCA CODE PROGRAM

Data Update with 19 new cutting cards

SKP Vers. 20.6.x.xx



Unocode 199

Data update with 19 new cutting cards. / Aggiornamento dati con 19 nuove schede. / Datenaktualisierung mit 19 neuen Karten. / Mise à jour des données avec 19 nouvelles fiches. / Actualización datos con 19 fichas nuevas. / Atualização de dados com 19 fichas novas.

New items include: / Tra le novità: / Unter den Neuheiten: / Parmi les nouveautés: / Entre las novedades: / Entre as novidades:



Unocode 299/399

- Goal® AD5
- Metal® X6S - X6V
- Schlage® Everest SFIC
- Snc® – 30/30
- Cisa® CS501
- Bunka®
- Yamaha®
- Honda®



Unocode 399 Evo



Update the software on: / Aggiornare il software di: / Aktualisierung der Software von: / Mettre à jour le logiciel de: / Actualizar el software de: / Atualizar o software de: UC199/UC299/UC399/UC399 EVO.

SILCA TRIAX - QUATTROCODE PROGRAM

Data Update with 8 new cutting cards

SKP Vers. 20.6.x.xx



Triax Quattro /
Triax e-code

Data update with 8 new series. / Aggiornamento dati con 8 nuove serie. / Daten-Aktualisierung mit 8 neuen Serien. / Mise à jour des données avec 8 nouvelles séries. / Actualización datos con 8 series nuevas. / Atualização de dados com 8 séries novas.

New items include: / Tra le novità: / Unter den Neuheiten: / Parmi les nouveautés: / Entre las novedades: / Entre as novidades:

- Yale® YA35/40 MSG SN
- Metal® 2x6J 30/30 (6P)
- Trelock® RS430 (4T-7W)
- Iseo® R7 Extra
- Wilka® W500
- Lehmann Prestige® B5
- Agent® BJ-1(5+5+5)
- Showa® W2-DAC (4T-4W)



Quattrocode



Update the software on: / Aggiornare il software di: / Aktualisierung der Software von: / Mettre à jour le logiciel de: / Actualizar el software de: / Atualizar o software de: TRIAX e-code, TRIAX QUATTRO.

SILCA TRANSPONDER PROGRAM

Data Update with 70 new vehicle applications

STP Vers. 03.16.076



RW4 / RW4 Plus



Fast Copy /
Fast Copy Plus

UK The Silca Transponder Program has been updated with 70 new vehicle applications.

- New software version 03.16.076 for all RW devices.
- Added Dutch and Hungarian.

DE Das Silca Transponder Program wurde mit 70 neuen Autoapplikationen aktualisiert.

- Neue Softwareversion 03.16.076 für alle RW-Geräte.
- Hinzufügen Sprache: Holländisch und Ungarisch.

ES Se ha actualizado el Silca Transponder Program con 70 nuevas aplicaciones vehículo.

- Nueva versión de software 03.16.076 para todos los dispositivos RW.
- Agregado los idiomas holandés y húngaro.

IT Il Silca Transponder Program è stato aggiornato con 70 nuove applicazioni auto.

- Nuova versione Software 03.16.076 per tutti i dispositivi RW.
- Aggiunta di olandese e ungherese.

FR Silca Transponder Program a été mis à jour avec 70 nouvelles applications auto.

- Nouvelle version Software 03.16.076 pour tous les dispositifs Transponder.
- Ajoutée des langues néerlandais et hongrois.

PT O Silca Transponder Program foi atualizado com 70 novas aplicações para automóvel.

- Nova versão de software 03.16.076 para todos os dispositivos RW.
- Adicionado as línguas holandesa e húngara.



Update the software on: / Aggiornare il software di: / Aktualisierung der Software von: / Mettre à jour le logiciel de: / Actualizar el software de: / Atualizar o software de: RW4, RW4 PLUS, FAST COPY, FAST COPY PLUS.

SILCA REMOTE SERVICE

Utility Update

SRS Vers. 1.0.32.5



UK SRS, the utility for updating programs on board devices in the RW and Optika families, Futura and Easy Scan over the Internet, has been updated.

DE SRS, das Utility zur Aktualisierung des internen Programms der Geräte in den Familien RW, Optika, Futura und Easy Scan über Internet, wurde aktualisiert.

ES Se ha actualizado SRS, la utility para actualizar el programa interior de los dispositivos de la familia RW, Optika, Easy Scan y Futura por medio de Internet.

IT SRS, l'utility per l'aggiornamento del programma interno dei dispositivi della famiglia RW, Optika, Futura e Easy Scan tramite Internet, è stato aggiornato.

FR SRS, l'utilitaire pour la mise à jour du programme interne des dispositifs de la famille RW, Optika, Futura et Easy Scan sur Internet, a été mis à jour.

PT SRS, o utilitário para a atualização do programa interno dos dispositivos da família RW, de Optika, Futura e Easy Scan por meio da Internet, foi atualizado.



Click here to download the latest version. / Clicca qui per scaricare l'ultima versione. / Klicken Sie hier, um die neueste Version herunterzuladen. / Cliquez ici pour télécharger la dernière version. / Haga clic aquí para descargar la última versión. / Clique aqui para baixar a versão mais recente.

SILCA FUTURA PROGRAM

Data Update with new main series

FUTURA Vers. 2.9.0



Futura

Data update with new main series. / Aggiornamento dati con nuove serie principali. / Datenaktualisierung mit neuen Hauptserien. / Mise à jour des données avec nouvelles séries principales. / Actualización de datos con nuevas series principales. / Atualização de dados com novas séries principais.

- Agent® BJ-1(5+5+5)
- BKS® WS42 - WS50 MK
- Bunka®
- Ces® UDM (4P) - WSM NEW (5+5+6)
- Dom® (Dom RS8)
- Dom® IX5 DAS (pf.038/101)
- Dom® IX6 SR E (prof.232)
- Dom® IX6 SR E (prof.233)
- Dom® IX6KG (prof. 102) (5+5+5)
- Dom® IX6SR E (prof. 230)
- Dom® IX6SR E (prof. 235)
- Dom® IX6SR E (prof. 129/130/241) MK
- Dom® IX6SR E (prof.131/132/233) MK
- Dom® IX6SR E (prof.232/234) AT
- Dorma® 2 in 1 (Prof. 233) (5P)
- Ezcurra® DS10/15 (5+5)
- FCV® (6P) - (6+5+4)
- Giobert® Alfa Romeo® GT2AP - (5+5)
- Lancia® GT2 (5+5)
- Goal® AD5
- Honda®
- Iseo® R7 Extra
- Metal® X6S - X6V
- Mg® HS Plus (5+5+5)
- Schlage® Everest SFIC
- Showa® W2-DAC (4T-4W)
- Snc® - 30/30
- Titan® T200
- Wilka® PR300
- Wilka® Carat - P3
- Wilka® Carat - P1
- Wilka® PR100
- Yamaha®

® are registered trademarks. / sono marchi registrati. / sind eingetragene Marken. / sont des marques déposées. / son marcas registradas. / são marcas registradas.

SILCA FUTURA PROGRAM

New Functions

FUTURA Vers. 2.9.0

New Functions / Nuove Funzioni / Neue Funktionen / Nouvelles Fonctions / Nuevas Funciones / Novas Funções

-  - New Function “Cutting Tree” from “Card => Partial cuts”. This function shows you how to recut multiple codes onto the same key blank so you can test each one and use a minimum number of key blanks.
- New Function “Cutting speed tuning” on Copy by original, copy by card for standard, laser and dimple keys. Using this function, it's possible to change the “cutting speed” and the “Depth removal step” according to the thickness and the material of the blank key to be cut.
- Turkish language.

-  - Nuova funzione “Albero di taglio” accessibile da “scheda => intagli parziali”. Questa funzione mostra come cifrare più combinazioni sulla stessa chiave, che può essere provata nel cilindro, utilizzando il minor numero di chiavi possibile.
- Nuova funzione “Variazione della velocità di taglio” in copia da originale e in copia a scheda per chiavi piatte, laser e punzonate. Tale funzione permette all'utente di modificare la velocità di avanzamento e l'asportazione di materiale in base al materiale e allo spessore della chiave da cifrare.
- Lingua Turca.



Remember to update the Silca.apk after installing the Software update (see the on board Instructions Manual - Ch 6.2 APP UPDATE (apk)).



Ricordarsi di aggiornare il Silca.apk dopo l'installazione dell'aggiornamento (vedi istruzioni nel Manuale d'uso - Cap. 6.2 AGGIORNAMENTO APP (apk)).

SILCA FUTURA PROGRAM New Functions

FUTURA Vers. 2.9.0

New Functions / Nuove Funzioni / Neue Funktionen / Nouvelles Fonctions / Nuevas Funciones / Novas Funções

- Neue Funktion **“Fräswelle” erreichbar über “Karte => Teilfräsungen”**. Diese Funktion zeigt wie mehrere Kombinationen auf dem selben Schlüssel gefräst werden können. Am Zylinder zu testen, um möglichst wenige Schlüssel zu verwenden.

- Neue Funktion **“Änderung der Fräsgeschwindigkeit”** beim Kopieren vom Original und beim Kopieren von Karte bei Flach-, Bahnen- und Bohrmuldenschlüssel. Diese Funktion ermöglicht es dem Nutzer die Geschwindigkeit des Fräsvorgangs und der Materialabtragung je nach Material und Stärke des zu fräsenden Schlüssels zu ändern.

- **Türkische Sprache.**



Erinnern Sie sich die Silca apk nach der Installation des Updates zu aktualisieren (siehe Anleitungen des Betriebs-Handbuches - Kap. 6.2 UPDATE DER APP (apk)).

- Nouvelle fonction **“Arbre de taillage” accessible de “onglet => entailles partielles”**. Cette fonction montre comment tailler plusieurs combinaisons sur la même clé, qui peut être testée dans le cylindre, en utilisant le moins de clés possible.

- Nouvelle fonction de **“Variation de la vitesse de taillage”** par copie à partir d'un original et de copie à partir d'un onglet pour les clés plates, laser et points. Grâce à cette fonction, l'utilisateur pourra modifier la vitesse d'amenage et l'ablation de matériau en fonction du dit matériau et de l'épaisseur de la clé à tailler.

- **Turc.**



Mettre à jour Silca.apk après l'installation de la mise à jour (voir instructions dans le Mode d'Emploi - Chap. 6.2 MISE À JOUR APP (apk)).

- Nueva función **“Gama de cortes” accesible desde la “tarjeta => cortes parciales”**. Esta función muestra el modo para cortar varias combinaciones en la misma llave, que puede probarse en el cilindro, y utilizar así el menor número posible de llaves.

- Nueva función **“Variación de la velocidad de corte”** en copia desde original y en copia en tarjeta para llaves planas, láser y de seguridad. Dicha función permite al usuario modificar la velocidad de avance y la extracción de material según el material y el grosor de la llave cortada.

- **Idioma turco.**



Se recuerda que Silca.apk se ha de actualizar tras instalar la actualización (véanse las instrucciones del Manual de uso - Cap. 6.2 ACTUALIZACIÓN DE LA APP (apk)).

- Nova função **“Veio de corte” alcançável de “ficha => entalhes parciais”**. Esta função mostra como cortar mais combinações na mesma chave, que pode ser provada no cilindro, utilizando o menor número de chaves possível.

- Nova função **“Variação da velocidade de corte”** na cópia de original e na cópia de ficha para chaves planas, laser e de pontos. Essa função permite ao utilizador modificar a velocidade de avanço e a remoção de material de acordo com o material e a espessura da chave a cortar.

- **Idioma Turco.**



Lembrar de atualizar o Silca.apk após a instalação da atualização (ver as instruções no Manual de Utilização - Cap. 6.2 ATUALIZAÇÃO APP (apk)).

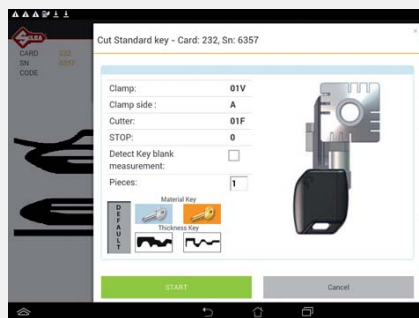

Standard key cutting

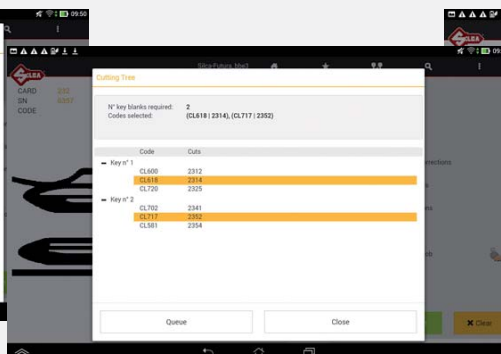

Cutting tree function

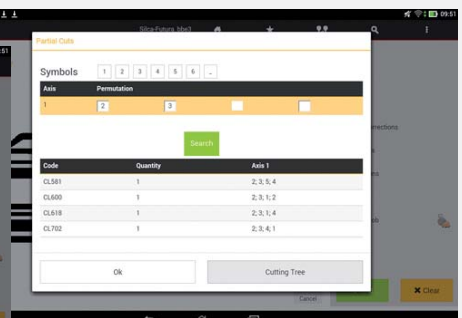

Partial cuts function

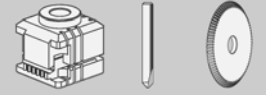
Accessories / Accessori / Zubehör / Accessoires / Accesorios / Acessórios

 FOR:
PER:

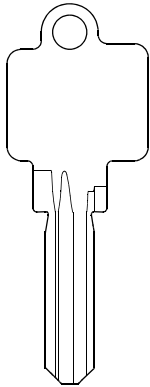
BKS (D)

FUTURA

> SW Futura 2.9

OPTIONAL

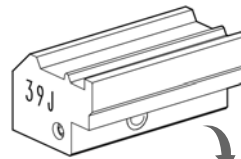
NEW
D744485ZB

 39J Jaw
Ganascia 39J
39J Backe
Mâchoire 39J
Quijada 39J
Garra 39J

OPTIONAL

NEW
D744482ZB

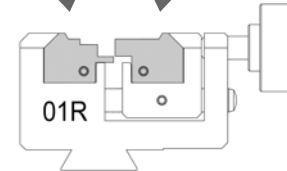
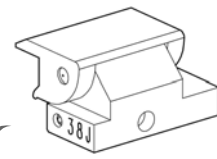
 38J Jaw
Ganascia 38J
38J Backe
Mâchoire 38J
Quijada 38J
Garra 38J

 Delivery time MARCH 2015
Disponibilit  MARZO 2015
Lieferbar M RZ 2015
Disponibilit  MARS 2015
Disponibilidad MARZO 2015
Disponibilidade MAR O 2015

STANDARD

D742606ZB

 Cutter 01L
Fresa 01L
Fr ser 01L
Fraise 01L
Fresa 01L
Fresa 01L

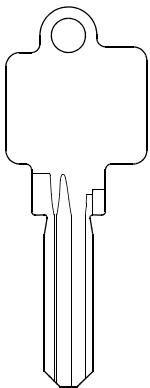
 FOR:
PER:

BKS (D)

FUTURA

> SW Futura 2.9

OPTIONAL

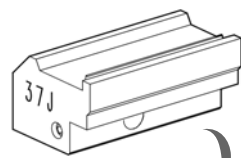
NEW
D744480ZB

 37J Jaw
Ganascia 37J
37J Backe
M choire 37J
Quijada 37J
Garra 37J

OPTIONAL

NEW
D744482ZB

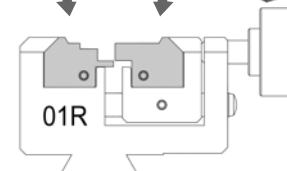
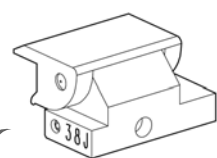
 38J Jaw
Ganascia 38J
38J Backe
M choire 38J
Quijada 38J
Garra 38J

 Delivery time MARCH 2015
Disponibilit  MARZO 2015
Lieferbar M RZ 2015
Disponibilit  MARS 2015
Disponibilidad MARZO 2015
Disponibilidade MAR O 2015

STANDARD

D742606ZB

 Cutter 01L
Fresa 01L
Fr ser 01L
Fraise 01L
Fresa 01L
Fresa 01L

FOR:
PER:

BKS (D)

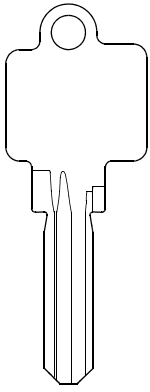

(WS50)



**MATRIX PRO - EVO
MATRIX ONE**

MATRIX S - SX - SLX

OPTIONAL



D744822ZB

Adapters A42
Adattatori A42
Adapters A42
Adaptateurs A42
Adaptadores A42
Adaptadores A42

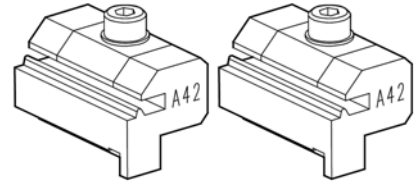

Delivery time MARCH 2015
Disponibilità MARZO 2015
Lieferbar MARZ 2015
Disponibilit  MARS 2015
Disponibilidad MARZO 2015
Disponibilidade MARO 2015

OPTIONAL

D740397ZB

Tracer point T68
Tastatore T68
Taster T68
Palpeur T68
Palpador T68
Palpador T68



D740474ZB

Cutter F68
Fresa F68
Fr ser F68
Fraise F68
Fresa F68

FOR:
PER:

CES (D)

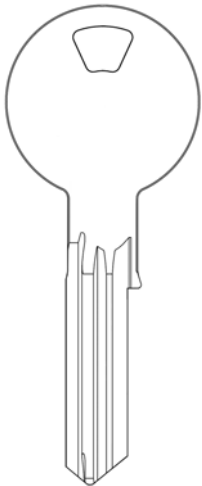

(UDM)



FUTURA

> SW Futura 2.9

OPTIONAL



D744505ZB

49J Jaw
Ganascia 49J
49J Backe
M choire 49J
Quijada 49J
Garra 49J

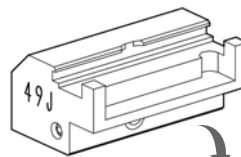

OPTIONAL



D744311ZB

25J Jaw
Ganascia 25J
25J Backe
M choire 25J
Quijada 25J
Garra 25J

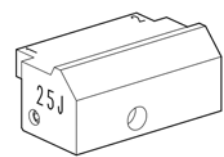

OPTIONAL



D744513ZB

Cutter 12D
Fresa 12D
Fr ser 12D
Fraise 12D
Fresa 12D
Fresa 12D

Delivery time MARCH 2015
Disponibilit  MARZO 2015
Lieferbar M RZ 2015
Disponibilit  MARS 2015
Disponibilidad MARZO 2015
Disponibilidade MARO 2015

FOR:
PER:

DOM (D)

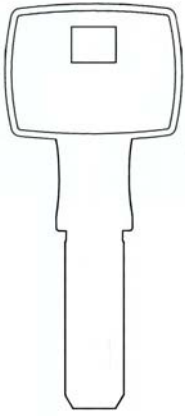

IX6SR E

(prof. 129, 130, 241)

(prof. 131, 132, 233)

(prof. 230, 232, 234, 235)

System protected by a password issued by Silca on receipt of authorization.

Sistema protetto da password rilasciata da Silca a fronte di autorizzazione.

Sysyem geschützt durch von Silca geliefertes Password auf Genehmigung.

Système protégé par un password qui est émis par Silca sur autorisation.

Sistema protegido por password que expide Silca contra autorización.

Sistema protegido por uma password emitida por Silca contra a autorização.



FUTURA

> SW Futura 2.9



OPTIONAL



D744495ZB

44J Jaw
Ganascia 44J
44J Backe
Mâchoire 44J
Quijada 44J
Garra 44J

STANDARD



D943254ZR

02J Jaw
Ganascia 02J
02J Backe
Mâchoire 02J
Quijada 02J
Garra 02J

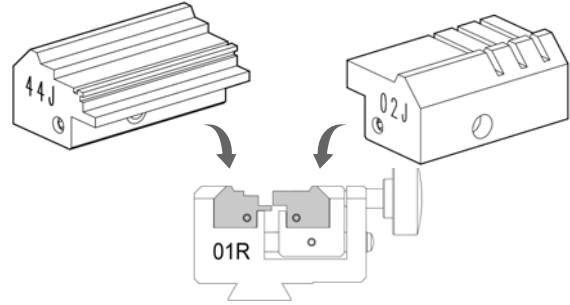

OPTIONAL



D744508ZB

Cutter 09D
Fresa 09D
Fräser 09D
Fraise 09D
Fresa 09D
Fresa 09D

Delivery time MARCH 2015
Disponibilità MARZO 2015
Lieferbar MÄRZ 2015
Disponibilité MARS 2015
Disponibilidad MARZO 2015
Disponibilidade MARÇO 2015

FOR:
PER:

DOM (D) CORBIN (I)

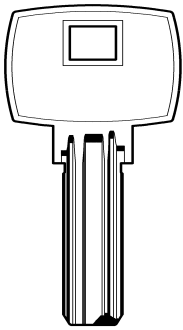

IX5 DAS

(prof. 038/101)



FUTURA

> SW Futura 2.9



OPTIONAL



D744487ZB

40J Jaw
Ganascia 40J
40J Backe
Mâchoire 40J
Quijada 40J
Garra 40J



OPTIONAL



D744489ZB

41J Jaw
Ganascia 41J
41J Backe
Mâchoire 41J
Quijada 41J
Garra 41J

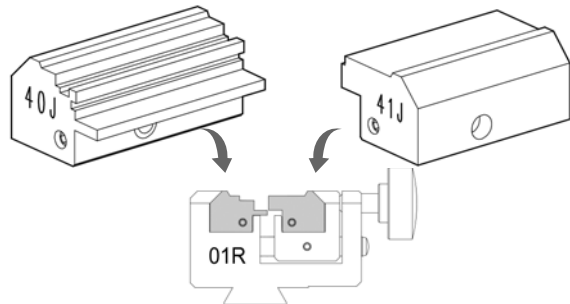

STANDARD



D742867ZB

Cutter 01D
Fresa 01D
Fräser 01D
Fraise 01D
Fresa 01D
Fresa 01D

Delivery time MARCH 2015
Disponibilità MARZO 2015
Lieferbar MÄRZ 2015
Disponibilité MARS 2015
Disponibilidad MARZO 2015
Disponibilidade MARÇO 2015

FOR:
PER:

DOM (D)

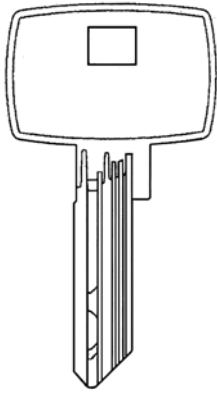

(RS8)



FUTURA

> SW Futura 2.9

OPTIONAL

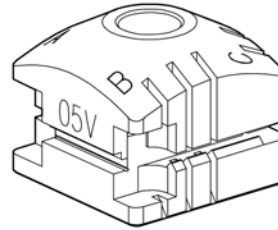

D744762ZB

05V clamp for DOM RS8 type keys
Morsetto 05V per chiavi tipo DOM RS8
Spannbacke 05V für DOM RS8 Schlüsseltyp
Etau 05V pour clés type DOM RS8
Mordaza 05V para llaves de tipo DOM RS8
Mordente 05V para chaves do tipo DOM RS8

Delivery time MARCH 2015
Disponibilità MARZO 2015
Lieferbar MÄRZ 2015
Disponibilit  MARZ 2015
Disponibilidad MARZO 2015
Disponibilidade MARÇO 2015

FOR:
PER:

LEHMANN (D)

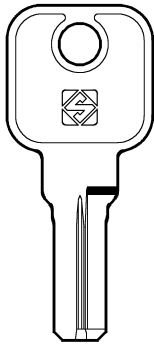

(Prestige B5)



QUATTROCODE



TRIAX QUATTRO
TRIAX-E.CODE

OPTIONAL



CARD 3868
SN 1559

D744648ZB

Adapter A41
Adattatore A41
Adapter A41
Adaptateur A41
Adaptador A41
Adaptador A41

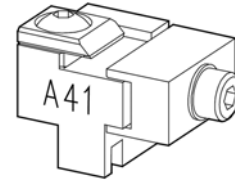

Delivery time MARCH 2015
Disponibilit  MARZO 2015
Lieferbar MARZ 2015
Disponibilit  MARZ 2015
Disponibilidad MARZO 2015
Disponibilidade MARÇO 2015

OPTIONAL



D711604ZB

Cutter W129 (carbide)
Fr ser W129 (Hartmetall)
Fraise W129 (au carbure)
Fresa W129 (metal duro)
Fresa W129 (metal duro)
Fresa W129 (metal duro)

Starting from SKP Software version 20.6.0.54
Dalla versione Software SKP 20.6.0.54
Ab SKP Software Version 20.6.0.54
  partir du software SKP version 20.6.0.54
Desde software SKP versi n 20.6.0.54
A partir da vers o software SKP 20.6.0.54

OPTIONAL



D744652ZB

Adapters A41
Adattatori A41
Adapters A41
Adaptateurs A41
Adaptadores A41
Adaptadores A41

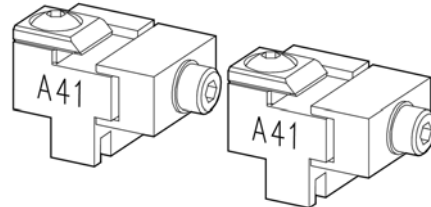

Delivery time MARCH 2015
Disponibilit  MARZO 2015
Lieferbar MARZ 2015
Disponibilit  MARS 2015
Disponibilidad MARZO 2015
Disponibilidade MARÇO 2015

OPTIONAL

D740360ZB

Tracer point T30
Tastatore T30
Taster T30
Palpeur T30
Palpador T30
Palpador T30



D740434ZB

Cutter F30
Fresa F30
Fr ser F30
Fraise F30
Fresa F30
Fresa F30



MATRIX PRO - EVO



MATRIX S - SX - SLX

FOR:
PER:

MG MONTI (I)

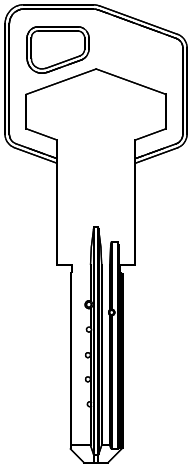

(HSP)

*System protected by a password issued by Silca on receipt of authorization.
Sistema protetto da password rilasciata da Silca a fronte di autorizzazione.
System geschützt durch von Silca geliefertes Passwort auf Genehmigung.
Système protégé par un password qui est émis par Silca sur autorisation.
Sistema protegido por password que expide Silca contra autorización.
Sistema protegido por uma password emitida por Silca contra a autorização.*



FUTURA

> SW Futura 2.9

OPTIONAL



D744491ZB

42J Jaw
Ganascia 42J
42J Backe
Mâchoire 42J
Quijada 42J
Garra 42J



OPTIONAL



D744493ZB

43J Jaw
Ganascia 43J
43J Backe
Mâchoire 43J
Quijada 43J
Garra 43J

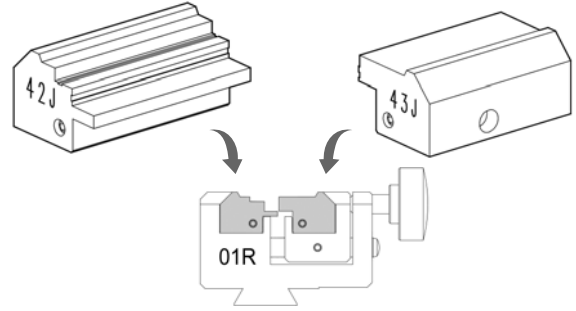

STANDARD



D742867ZB

Cutter 01D
Fresa 01D
Fräser 01D
Fraise 01D
Fresa 01D
Fresa 01D

Delivery time MARCH 2015
Disponibilità MARZO 2015
Lieferbar MÄRZ 2015
Disponibilité MARS 2015
Disponibilidad MARZO 2015
Disponibilidade MARÇO 2015

FOR:
PER:

WILKA (D)

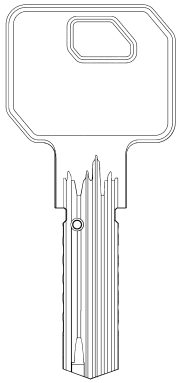

(PR100)
(Carat - P1)



FUTURA

> SW Futura 2.9

OPTIONAL



D744309ZB

24J Jaw
Ganascia 24J
24J Backe
Mâchoire 24J
Quijada 24J
Garra 24J

OPTIONAL



D744311ZB

25J Jaw
Ganascia 25J
25J Backe
Mâchoire 25J
Quijada 25J
Garra 25J

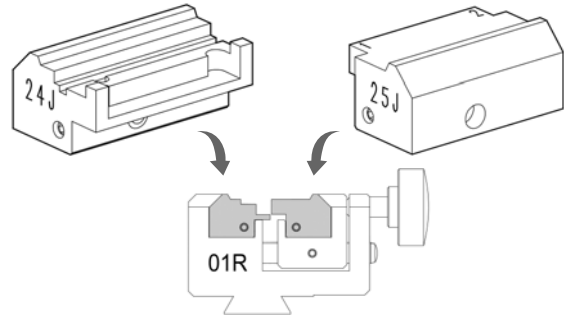

OPTIONAL



D743673ZB

Cutter 02D
Fresa 02D
Fräser 02D
Fraise 02D
Fresa 02D
Fresa 02D

Delivery time MARCH 2015
Disponibilità MARZO 2015
Lieferbar MÄRZ 2015
Disponibilité MARS 2015
Disponibilidad MARZO 2015
Disponibilidade MARÇO 2015

FOR:
PER:

WILKA (D)

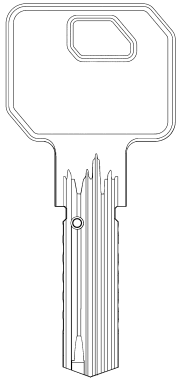

(PR300)
(Carat - P3)



FUTURA

> SW Futura 2.9

OPTIONAL



D744503ZB

48J Jaw
Ganascia 48J
48J Backe
Mâchoire 48J
Quijada 48J
Garra 48J



OPTIONAL



D744501ZB

47J Jaw
Ganascia 47J
47J Backe
Mâchoire 47J
Quijada 47J
Garra 47J

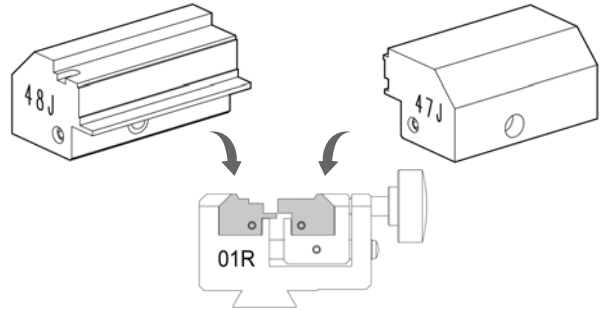

STANDARD



D742867ZB

Cutter 01D
Fresa 01D
Fräser 01D
Fraise 01D
Fresa 01D
Fresa 01D

Delivery time MARCH 2015
Disponibilità MARZO 2015
Lieferbar MÄRZ 2015
Disponibilit  MARS 2015
Disponibilidad MARZO 2015
Disponibilidade MARÇO 2015

FOR:
PER:

WILKA (D)

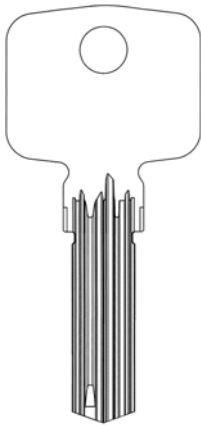

(3VE-W500)



MATRIX PRO - EVO



MATRIX S - SX - SLX

OPTIONAL



D744801ZB

Adapters A23
Adattatori A23
Adapters A23
Adaptateurs A23
Adaptadores A23
Adaptadores A23

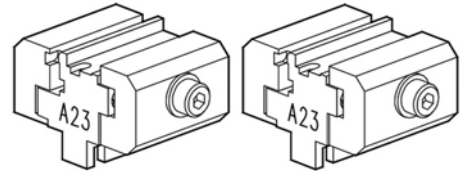

OPTIONAL

D740341ZB

Tracer point T13
Tastatore T13
Taster T13
Palpeur T13
Palpador T13
Palpador T13



D744803ZB

Cutter F73
Fresa F73
Fräser F73
Fraise F73
Fresa F73
Fresa F73

Delivery time MARCH 2015
Disponibilità MARZO 2015
Lieferbar MARZ 2015
Disponibilit  MARS 2015
Disponibilidad MARZO 2015
Disponibilidade MARÇO 2015



SILCA NEWS 04/15

ALL THE NEW KEYS, AUTOMOTIVE SOLUTIONS, KEY CUTTING MACHINES, SOFTWARE UPDATES AND MUCH MORE





Contents

New Keys	1
Empty Shells - New Reference	2
Vehicle Keys Guide	3, 4
Silca EKC - Comparative Update	5



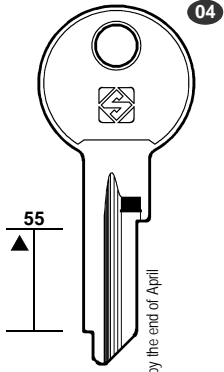
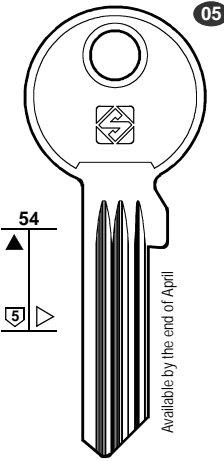
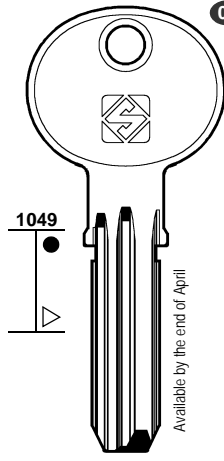

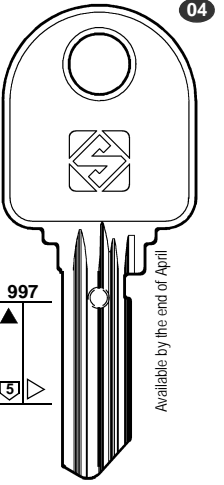
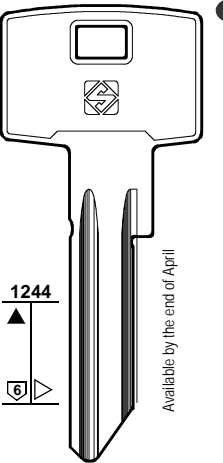
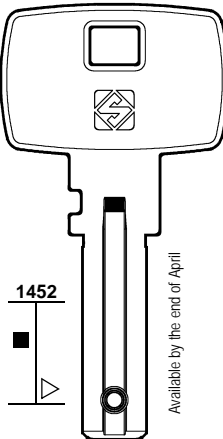

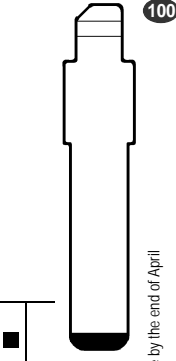
New Keys / Chiavi Nuove / Neue Schlüssel / Nouvelles Clés / Llaves Nuevas / Chaves Nuevas

FOR: PER:	BURG	EVVA	HTEC	FOR / PER	
	 <p>55</p> <p>Available by the end of April</p> <p>BUR60R</p>	 <p>54</p> <p>Available by the end of April</p> <p>EV110RX EV111RX</p>	 <p>1049</p> <p>Available by the end of April</p> <p>HTE1</p> 	BURG (D) EVVA (A) HTEC (E) LAPERCHE (F) PFAFFENHAIN (D) STS (E) TRW SIPEA (I)	
FOR: PER:	LAPERCHE	PFAFFENHAIN	STS	TRW SIPEA	
	 <p>997</p> <p>Available by the end of April</p> <p>LH43R</p>	 <p>1244</p> <p>Available by the end of April</p> <p>PHF32</p>	 <p>1452</p> <p>Available by the end of April</p> <p>STS12</p> 	 <p>100</p> <p>Available by the end of April</p> <p>S583 S1134</p> <p>SIP37T DE 1-11210</p>	<p>01</p> <p>COMMERCIAL GROUP GRUPPO COMMERCIALE PREISEGRUPPE GROUPE COMMERCIAL GRUPO COMMERCIAL GRUPO COMERCIAL</p> <p>www.silca.biz</p>



SILCA EMPTY SHELLS - NEW REFERENCES

 Silca Empty Shells: **1 new key reference** to widen the existing range.

 Silca Empty Shells: **1 nouvelle référence** clés qui complètent la gamme existante.

 Silca Empty Shells: **1 nuova referenza** chiavi che implementano la gamma già esistente.

 Silca Empty Shells: **1 nueva referencia** llaves que completan la gama existente.

 Silca Empty Shells: **1 Schlüssel Referenz** die das bestehende Angebot implementieren.

 Silca Empty Shells: **1 nova referência** chaves que implementam a gama existente.

Brand	References/Image	Specifications	Vehicle Models*																																																																																																																																																																					
NISSAN®	<p>NSNRS2</p>  <p>Available in Stock</p>	2 Buttons	<table border="1"> <thead> <tr> <th>MODELS</th> <th>YEAR FROM</th> <th>YEAR TO</th> <th>TRANSPONDER TYPE</th> <th>TRP ID</th> </tr> </thead> <tbody> <tr> <td colspan="5">NISSAN®</td> </tr> <tr> <td>ALMERA</td> <td>1999</td> <td>2000</td> <td>PH/CR</td> <td>41</td> </tr> <tr> <td>ALMERA</td> <td>2000</td> <td>2003</td> <td>TEX/CR</td> <td>60</td> </tr> <tr> <td>ALMERA TINO</td> <td>2000</td> <td>2003</td> <td>TEX/CR</td> <td>60</td> </tr> <tr> <td>MAXIMA</td> <td>2000</td> <td>2003</td> <td>PH/CR</td> <td>41</td> </tr> <tr> <td>MICRA</td> <td>1998</td> <td>2000</td> <td>PH/CR</td> <td>41</td> </tr> <tr> <td>MICRA</td> <td>2000</td> <td>2003</td> <td>TEX/CR</td> <td>60</td> </tr> <tr> <td>MICRA MARCH [J]</td> <td>1998</td> <td>2000</td> <td>PH/CR</td> <td>41</td> </tr> <tr> <td>MICRA MARCH [J]</td> <td>2000</td> <td>2003</td> <td>TEX/CR</td> <td>60</td> </tr> <tr> <td>MICRA VAN</td> <td>1998</td> <td>2000</td> <td>PH/CR</td> <td>41</td> </tr> <tr> <td>MICRA VAN</td> <td>2000</td> <td>2003</td> <td>TEX/CR</td> <td>60</td> </tr> <tr> <td>MURANO</td> <td>2003</td> <td>2007</td> <td>TEX/CR</td> <td>60</td> </tr> <tr> <td>NAVARA</td> <td>2000</td> <td>2003</td> <td>PH/CR</td> <td>41</td> </tr> <tr> <td>NAVARA</td> <td>2003</td> <td>2005</td> <td>TEX/CR</td> <td>60</td> </tr> <tr> <td>NAVARA</td> <td>2003</td> <td>2005</td> <td>TEX/CR</td> <td>60</td> </tr> <tr> <td>NX ALMERA</td> <td>1998</td> <td>2000</td> <td>PH/CR</td> <td>41</td> </tr> <tr> <td>PATROL</td> <td>1998</td> <td>2003</td> <td>PH/CR</td> <td>41</td> </tr> <tr> <td>PATROL</td> <td>2004</td> <td>2006</td> <td>TEX/CR</td> <td>60</td> </tr> <tr> <td>PRIMERA</td> <td>1998</td> <td>2000</td> <td>TEX/CR</td> <td>60</td> </tr> <tr> <td>PRIMERA</td> <td>2000</td> <td>2002</td> <td>PH/CR</td> <td>41</td> </tr> <tr> <td>PULSAR</td> <td>1998</td> <td>2000</td> <td>TEX/CR</td> <td>60</td> </tr> <tr> <td>PULSAR</td> <td>2000</td> <td>2004</td> <td>PH/CR</td> <td>41</td> </tr> <tr> <td>TERRANO II</td> <td>1998</td> <td>2001</td> <td>PH/CR</td> <td>41</td> </tr> <tr> <td>TERRANO II</td> <td>2002</td> <td>2006</td> <td>TEX/CR</td> <td>60</td> </tr> <tr> <td>VANETTE</td> <td>2000</td> <td>2002</td> <td>TEX/CR</td> <td>60</td> </tr> <tr> <td>VANETTE CARGO</td> <td>1999</td> <td>2000</td> <td>PH/CR</td> <td>41</td> </tr> <tr> <td>VANETTE CARGO</td> <td>2000</td> <td>2001</td> <td>TEX/CR</td> <td>60</td> </tr> <tr> <td>X-TRAIL</td> <td>2001</td> <td>2003</td> <td>TEX/CR</td> <td>60</td> </tr> <tr> <td>X-TRAIL</td> <td>2004</td> <td>2006</td> <td>TEX/CR</td> <td>60</td> </tr> <tr> <td colspan="5">NISSAN® (TRUCK)</td> </tr> <tr> <td>ATLEON</td> <td>2002</td> <td>2006</td> <td>TEX/CR</td> <td>60</td> </tr> <tr> <td>CAB STAR</td> <td>2000</td> <td>2007</td> <td>TEX/CR</td> <td>60</td> </tr> </tbody> </table>	MODELS	YEAR FROM	YEAR TO	TRANSPONDER TYPE	TRP ID	NISSAN®					ALMERA	1999	2000	PH/CR	41	ALMERA	2000	2003	TEX/CR	60	ALMERA TINO	2000	2003	TEX/CR	60	MAXIMA	2000	2003	PH/CR	41	MICRA	1998	2000	PH/CR	41	MICRA	2000	2003	TEX/CR	60	MICRA MARCH [J]	1998	2000	PH/CR	41	MICRA MARCH [J]	2000	2003	TEX/CR	60	MICRA VAN	1998	2000	PH/CR	41	MICRA VAN	2000	2003	TEX/CR	60	MURANO	2003	2007	TEX/CR	60	NAVARA	2000	2003	PH/CR	41	NAVARA	2003	2005	TEX/CR	60	NAVARA	2003	2005	TEX/CR	60	NX ALMERA	1998	2000	PH/CR	41	PATROL	1998	2003	PH/CR	41	PATROL	2004	2006	TEX/CR	60	PRIMERA	1998	2000	TEX/CR	60	PRIMERA	2000	2002	PH/CR	41	PULSAR	1998	2000	TEX/CR	60	PULSAR	2000	2004	PH/CR	41	TERRANO II	1998	2001	PH/CR	41	TERRANO II	2002	2006	TEX/CR	60	VANETTE	2000	2002	TEX/CR	60	VANETTE CARGO	1999	2000	PH/CR	41	VANETTE CARGO	2000	2001	TEX/CR	60	X-TRAIL	2001	2003	TEX/CR	60	X-TRAIL	2004	2006	TEX/CR	60	NISSAN® (TRUCK)					ATLEON	2002	2006	TEX/CR	60	CAB STAR	2000	2007	TEX/CR	60
MODELS	YEAR FROM	YEAR TO	TRANSPONDER TYPE	TRP ID																																																																																																																																																																				
NISSAN®																																																																																																																																																																								
ALMERA	1999	2000	PH/CR	41																																																																																																																																																																				
ALMERA	2000	2003	TEX/CR	60																																																																																																																																																																				
ALMERA TINO	2000	2003	TEX/CR	60																																																																																																																																																																				
MAXIMA	2000	2003	PH/CR	41																																																																																																																																																																				
MICRA	1998	2000	PH/CR	41																																																																																																																																																																				
MICRA	2000	2003	TEX/CR	60																																																																																																																																																																				
MICRA MARCH [J]	1998	2000	PH/CR	41																																																																																																																																																																				
MICRA MARCH [J]	2000	2003	TEX/CR	60																																																																																																																																																																				
MICRA VAN	1998	2000	PH/CR	41																																																																																																																																																																				
MICRA VAN	2000	2003	TEX/CR	60																																																																																																																																																																				
MURANO	2003	2007	TEX/CR	60																																																																																																																																																																				
NAVARA	2000	2003	PH/CR	41																																																																																																																																																																				
NAVARA	2003	2005	TEX/CR	60																																																																																																																																																																				
NAVARA	2003	2005	TEX/CR	60																																																																																																																																																																				
NX ALMERA	1998	2000	PH/CR	41																																																																																																																																																																				
PATROL	1998	2003	PH/CR	41																																																																																																																																																																				
PATROL	2004	2006	TEX/CR	60																																																																																																																																																																				
PRIMERA	1998	2000	TEX/CR	60																																																																																																																																																																				
PRIMERA	2000	2002	PH/CR	41																																																																																																																																																																				
PULSAR	1998	2000	TEX/CR	60																																																																																																																																																																				
PULSAR	2000	2004	PH/CR	41																																																																																																																																																																				
TERRANO II	1998	2001	PH/CR	41																																																																																																																																																																				
TERRANO II	2002	2006	TEX/CR	60																																																																																																																																																																				
VANETTE	2000	2002	TEX/CR	60																																																																																																																																																																				
VANETTE CARGO	1999	2000	PH/CR	41																																																																																																																																																																				
VANETTE CARGO	2000	2001	TEX/CR	60																																																																																																																																																																				
X-TRAIL	2001	2003	TEX/CR	60																																																																																																																																																																				
X-TRAIL	2004	2006	TEX/CR	60																																																																																																																																																																				
NISSAN® (TRUCK)																																																																																																																																																																								
ATLEON	2002	2006	TEX/CR	60																																																																																																																																																																				
CAB STAR	2000	2007	TEX/CR	60																																																																																																																																																																				

* The uses of the keys are purely indicative and may be subject to updates and revisions. / Gli utilizzi delle chiavi sono da considerarsi puramente indicativi e possono essere oggetto di aggiornamenti e revisioni. / Die Abbildung und technischen Daten der Schlüssel sind nicht bindend. Silca behält sich Änderungen am Produkt, die zur Verbesserung beitragen, vor. / Les usages des clés sont purement indicatifs; ils peuvent être mis à jour et revus. / Los usos de las llaves deben considerarse puramente indicativos y pueden ser objeto de actualizaciones y revisiones. / As utilizações das chaves devem ser consideradas puramente indicativas e podem ser objecto de actualizações e revisões.

® Registered Trademarks. / ® Marchi Registrati. / ® Eingetragene Marken. / ® Marques Déposées. / ® Marcas Registradas. / ® Marcas Registradas.



Car Keys Guide / Guida Chiavi Auto / Marktführer für Autoschlüssel / Guide Clés pour Voitures
 Guía Llaves para Coches / Guia Chaves para Carros

New Updates

1	2	2a	3	3a	3b	E1+E2		6	42+71	72	43 44a	12	15
						GTI COMPATIBLE			IGNITION 				
CAR MAKE MODEL	FROM	TO	SILCA REF.	SILCA REF.	SILCA REF.	COPY	GEN.	TRANSP. TYPE	FAST COPY PLUS RW4 PLUS FAST COPY / RW4	FAST COPY PLUS RW4 PLUS	FAST COPY RW4	STP	

For more info on the uses of car keys, refer to the Silca Electronic Key Catalogue:



ALFA ROMEO®

VARIOUS MODELS	2005		SIP37T										
----------------	------	--	--------	--	--	--	--	--	--	--	--	--	--

CITROËN®

VARIOUS MODELS	2005		SIP37T										
----------------	------	--	--------	--	--	--	--	--	--	--	--	--	--

FIAT®

VARIOUS MODELS	2005		SIP37T										
----------------	------	--	--------	--	--	--	--	--	--	--	--	--	--

LANCIA®

VARIOUS MODELS			SIP37T										
----------------	--	--	--------	--	--	--	--	--	--	--	--	--	--

NISSAN®

ALMERA	1999	2000	NSNRS2					PH/CR	41				
ALMERA	2000	2003	NSNRS2					TEX/CR	60				
ALMERA TINO	2000	2003	NSNRS2					TEX/CR	60				
MAXIMA	2000	2003	NSNRS2					PH/CR	41				
MICRA	1998	2000	NSNRS2					PH/CR	41				
MICRA	2000	2003	NSNRS2					TEX/CR	60				
MICRA MARCH [J]	1998	2000	NSNRS2					PH/CR	41				
MICRA MARCH [J]	2000	2003	NSNRS2					TEX/CR	60				
MICRA VAN	1998	2000	NSNRS2					PH/CR	41				
MICRA VAN	2000	2003	NSNRS2					TEX/CR	60				
MURANO	2003	2007	NSNRS2					TEX/CR	60				
NAVARA	2000	2003	NSNRS2					PH/CR	41				
NAVARA	2003	2005	NSNRS2					TEX/CR	60				
NAVARA	2003	2005	NSNRS2					TEX/CR	60				
NX ALMERA	1998	2000	NSNRS2					PH/CR	41				
PATROL	1998	2003	NSNRS2					PH/CR	41				
PATROL	2004	2006	NSNRS2					TEX/CR	60				
PRIMERA	1998	2000	NSNRS2					TEX/CR	60				
PRIMERA	2000	2002	NSNRS2					PH/CR	41				
PULSAR	1998	2000	NSNRS2					TEX/CR	60				
PULSAR	2000	2004	NSNRS2					PH/CR	41				
TERRANO II	1998	2001	NSNRS2					PH/CR	41				

* The uses of the keys are purely indicative and may be subject to updates and revisions. / Gli utilizzi delle chiavi sono da considerarsi puramente indicativi e possono essere oggetto di aggiornamenti e revisioni. / Die Abbildung und technischen Daten der Schlüssel sind nicht bindend. Silca behält sich Änderungen am Produkt, die zur Verbesserung beitragen, vor. / Les usages des clés sont purement indicatifs; ils peuvent être mis à jour et revus. / Los usos de las llaves deben considerarse puramente indicativos y pueden ser objeto de actualizaciones y revisiones. / As utilizações das chaves devem ser consideradas puramente indicativas e podem ser objecto de actualizações e revisões.

© Registered Trademarks. / © Marchi Registrati. / © Eingetragene Marken. / © Marques Déposées. / © Marcas Registradas. / © Marcas Registradas.



**Car/Truck Keys Guide / Guida Chiavi Auto/Camion / Marktführer für LKW und Autoschlüssel
Guide Clés pour Voitures/Camions / Guía Llaves para Coches/Camiones / Guia Chaves para Carros/Camiões**

New Updates

1	2	2a	3	3a	3b	E1+E2		6	42+71	72	43 44a	12	15
						GTI COMPATIBLE							
CAR MAKE MODEL	FROM	TO	SILCA REF.	SILCA REF.	SILCA REF.	COPY	GEN.	TRANSP. TYPE	FAST COPY PLUS RW4 PLUS FAST COPY / RW4	FAST COPY PLUS RW4 PLUS	FAST COPY RW4	STP	
For more info on the uses of car keys, refer to the Silca Electronic Key Catalogue:													
NISSAN®													
TERRANO II	2002	2006	NSNRS2					TEX/CR	60				
VANETTE	2000	2002	NSNRS2					TEX/CR	60				
VANETTE CARGO	1999	2000	NSNRS2					PH/CR	41				
VANETTE CARGO	2000	2001	NSNRS2					TEX/CR	60				
X-TRAIL	2001	2003	NSNRS2					TEX/CR	60				
X-TRAIL	2004	2006	NSNRS2					TEX/CR	60				
X-TRAIL [J]	1998	2000	NSNRS2					PH/CR	41				
PEUGEOT®													
VARIOUS MODELS			SIP37T										

1	2	2a	3	3a	3b	E1+E2		6	42+71	72	43 44a	12	15
						GTI COMPATIBLE							
TRUCK MAKE MODEL	FROM	TO	SILCA REF.	SILCA REF.	SILCA REF.	COPY	GEN.	TRANSP. TYPE	FAST COPY PLUS RW4 PLUS FAST COPY / RW4	FAST COPY PLUS RW4 PLUS	FAST COPY RW4	STP	
For more info on the uses of truck keys, refer to the Silca Electronic Key Catalogue:													
NISSAN®													
ATLEON	2002	2006	NSNRS2					TEX/CR	60				
CAB STAR	2000	2007	NSNRS2					TEX/CR	60				



See also the "Vehicle Guide Legend"
Vedi anche la "Legenda Guida Veicoli"
Siehe auch die "Fahrzeugschlüssel Erläuterung"
Voir aussi la "Légende Guide Véhicules"
Véase también la "Leyenda Guía para Vehículos"
Veja também a "Legenda Guia para Veículos"

* The uses of the keys are purely indicative and may be subject to updates and revisions. / Gli utilizzi delle chiavi sono da considerarsi puramente indicativi e possono essere oggetto di aggiornamenti e revisioni. / Die Abbildung und technischen Daten der Schlüssel sind nicht bindend. Silca behält sich Änderungen am Produkt, die zur Verbesserung beitragen, vor. / Les usages des clés sont purement indicatifs; ils peuvent être mis à jour et revus. / Los usos de las llaves deben considerarse puramente indicativos y pueden ser objeto de actualizaciones y revisiones. / As utilizações das chaves devem ser consideradas puramente indicativas e podem ser objecto de actualizações e revisões.

© Registered Trademarks. / © Marchi Registrati. / © Eingetragene Marken. / © Marques Déposées. / © Marcas Registradas. / © Marcas Registradas.



Silca EKC - Comparative Update

🇬🇧 UPDATED COMPARATIVE REFERENCES

The comparative references of the Silca Electronic Key Catalogue have been updated. With EKC you can easily get the Silca reference corresponding to a key by another brand and search through the most extensive key database in the world.

🇫🇷 MISE À JOUR CODES COMPARATIFS

Les références comparatives du Catalogue Electronique Clés ont été mises à jour. Grâce à EKC, vous pourrez facilement accéder à la référence Silca correspondant à la clé d'une autre marque et lancer une recherche au sein du data base clés le plus vaste du monde.

🇮🇹 AGGIORNAMENTO CODICI COMPARATIVI

I codici comparativi del Catalogo Elettronico Chiavi sono stati aggiornati. Con EKC puoi facilmente accedere alla referenza Silca corrispondente alla chiave di un altro marchio ed effettuare ricerche all'interno del database chiavi più esteso al mondo.

🇪🇸 ACTUALIZACIÓN CÓDIGOS COMPARATIVOS

Los códigos comparativos del Catálogo Electrónico Llaves se han actualizado. EKC le permite acceder fácilmente a la referencia Silca correspondiente a la llave de otra marca y efectuar búsquedas en la base de datos de llaves más grande del mundo.

🇩🇪 AKTUALISIERUNG VERGLEICHS-ARTIKELNR.

Die Aktualisierung der Vergleichs-Artikelnummer des Elektronischen Schlüsselkatalogs ist verfügbar. Mit EKC haben Sie leichten Zugriff auf die Silca-Artikelreferenz, die dem Schlüssel eines Mitbewerbers entspricht und können in der umfassendsten Datenbank der Welt nachsuchen.

🇵🇹 ATUALIZAÇÃO CÓDIGOS COMPARATIVOS

Os códigos comparativos do Catálogo Electrónico Chaves foram atualizados. Com EKC pode ter acesso facilmente à referência Silca que corresponde à chave de uma outra marca e efectuar pesquisas na base de dados mais rica no mundo.

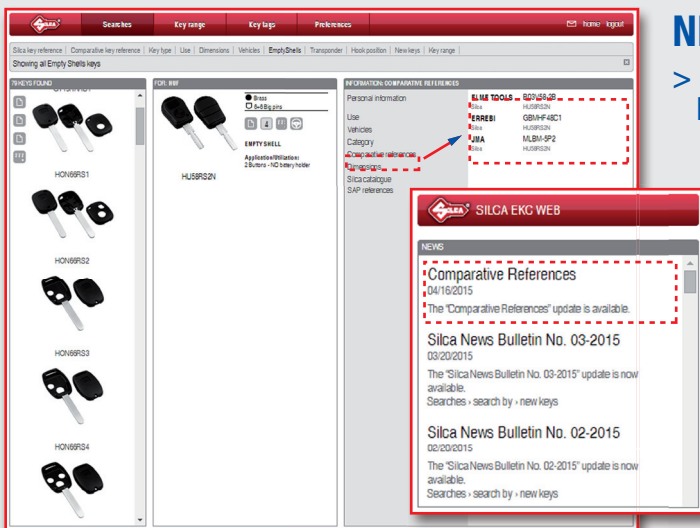

NEW COMPARATIVES

> Starting from this months are available the Empty Shells keys comparatives.

**Register on
 ekc.silca.biz
 It's free!**





SILCA NEWS 05/15

ALL THE NEW KEYS, AUTOMOTIVE SOLUTIONS, KEY CUTTING MACHINES, SOFTWARE UPDATES AND MUCH MORE

Contents

New Keys	1, 2, 3
Vehicle Keys Guide	4, 5
Silca Events in Europe	6
Silca Key Programs Update	7,8
Silca Futura Program Update	9,10
Key Machine Optional Accessories	11, 12

SILCA EVENTS IN MAY

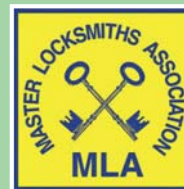

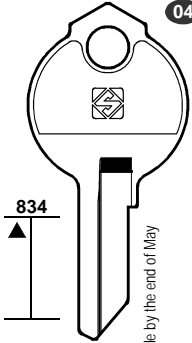
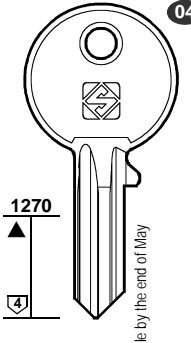
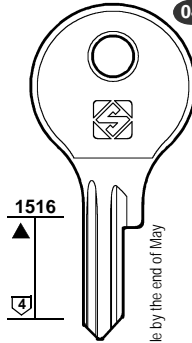
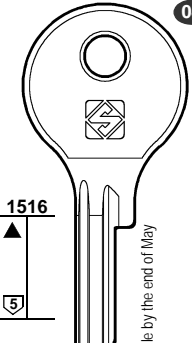
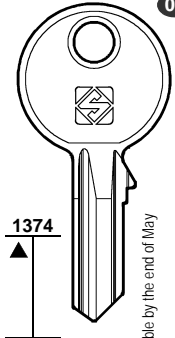
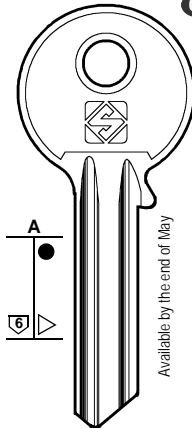

New Keys / Chiavi Nuove / Neue Schlüssel / Nouvelles Clés / Llaves Nuevas / Chaves Nuevas

FOR: PER:	ABUS	BURG				FOR / PER
	 <p>834 ▲ Available by the end of May</p> <p>04</p> <p>AB100 AB100R</p>	 <p>1270 ▲ 4 Available by the end of May</p> <p>04</p> <p>BUR25</p>	 <p>1516 ▲ 4 Available by the end of May</p> <p>04</p> <p>BUR35</p>	 <p>1516 ▲ 5 Available by the end of May</p> <p>04</p> <p>BUR36</p>	<p>ABUS (D)</p> <p>BURG (D)</p> <p>EMKA (D)</p> <p>FIAM (I)</p>	
FOR: PER:	EMKA		FIAM			
	 <p>1374 ▲ Available by the end of May</p> <p>04</p> <p>EMK13</p>	 <p>A ● 6 ▲ Available by the end of May</p> <p>02</p> <p>FI6</p>				

01
COMMERCIAL GROUP
GRUPPO COMMERCIALE
PREISEGRUPPE
GROUPE COMMERCIAL
GRUPO COMMERCIAL
GRUPO COMERCIAL

www.silca.biz

FOR / PER
 GERA (D)
 LOB (PL)
 MORI E. (I)
 SECUREMME (I)

FOR: **GERA**
 PER:

132

04

Available by the end of May

GR16

FOR: **LOB**
 PER:

1614

04

Available by the end of May

LOB9R

FOR: **LOB**
 PER:

1614

04

Available by the end of May

LOB10R

1613

04

Available by the end of May

LOB13

FOR: **MORI E.**
 PER:

472

02

Available by the end of May

MI8

FOR: **SECUREMME**
 PER:

A

02

Available by the end of May

SCM4

01
 COMMERCIAL GROUP
 GRUPPO COMMERCIALE
 PREISEGRUPPE
 GROUPE COMMERCIAL
 GRUPO COMMERCIAL
 GRUPO COMERCIAL
www.silca.biz

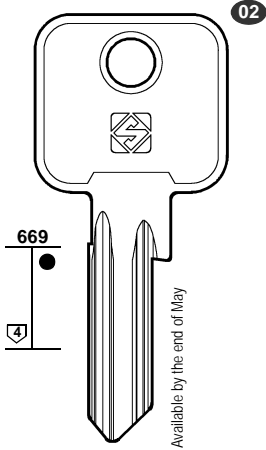
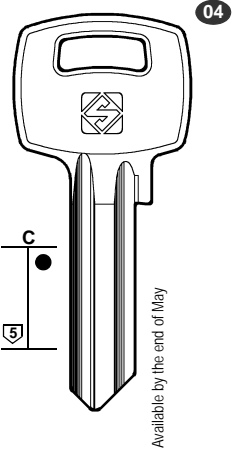
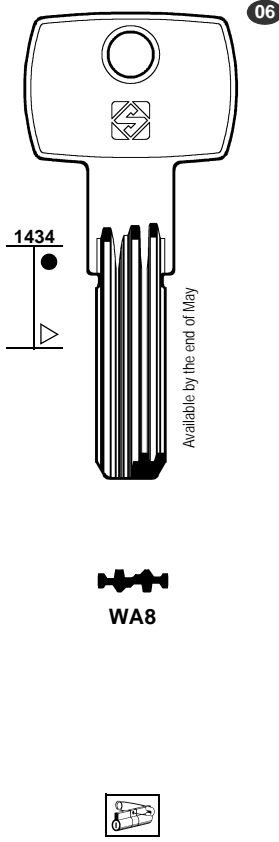
FOR: PER:	TARONI	VEROFER	WALLY	FOR / PER
	 <p>02</p> <p>669</p> <p>4</p> <p>Available by the end of May</p> <p>TAR26</p>	 <p>04</p> <p>C</p> <p>5</p> <p>Available by the end of May</p> <p>VRF3</p>	 <p>06</p> <p>1434</p> <p>Available by the end of May</p> <p>WA8</p>	<p>TARONI (I)</p> <p>VEROFER (RO)</p> <p>WALLY (I)</p>
FOR: PER:				

01
 COMMERCIAL GROUP
 GRUPPO COMMERCIALE
 PREISEGRUPPE
 GROUPE COMMERCIAL
 GRUPO COMMERCIAL
 GRUPO COMERCIAL

www.silca.biz



Car Keys Guide / Guida Chiavi Auto / Marktführer für Autoschlüssel / Guide Clés pour Voitures Guía Llaves para Coches / Guia Chaves para Carros

New Updates

1	2	2a	3	3a	3b	E1+E2		6	42+71	72	43 44a	12	15
						GTI COMPATIBLE							
CAR MAKE MODEL	FROM	TO	SILCA REF.	SILCA REF.	SILCA REF.	COPY	GEN.	TRANSP. TYPE	FAST COPY PLUS RW4 PLUS FAST COPY / RW4	FAST COPY PLUS RW4 PLUS	FAST COPY RW4	STP	

For more info on the uses of car keys, refer to the Silca Electronic Key Catalogue:

CHEVROLET® SUD AMERICA

ONIX	2012		HU100MH	HU100TE	HU100FH	Y		PH / CR2	46	Y	P-BOX		
PRISMA	2012		HU100MH	HU100TE	HU100FH	Y		PH / CR2	46	Y	P-BOX		
TRACKER	1998	2007	SZ12MH	SZ12TE	SZ12FH	Y	Y	TEXAS	4C	Y	P-BOX		
TRACKER	2013		HU100MH	HU100TE	HU100FH	Y		PH / CR2	46	Y	P-BOX		

CITROËN®

CACTUS	2014		VA6MH	VA2TE	VA6FH	Y		PH / CR2	46	Y	P-BOX		
--------	------	--	-------	-------	-------	---	--	----------	----	---	-------	--	--

FIAT®

GRAND SIENA	2012		SIP22MH	SIP22TE	SIP22FH	Y		PH / CR2	46	Y	P-BOX		
LINEA	2007							MEG / CR	48				
VIAGGIO	2013		SIP22MH	SIP22TE	SIP22FH	Y		PH / CR2	46	Y	P-BOX		
500X	2014							MEG / CR	48				
500X	2014		SMART KEY					PH / CR3	49-1C				

FORD® SUD-AMERICA

ECO-SPORT	2012							TEX / MA	6E				
-----------	------	--	--	--	--	--	--	----------	----	--	--	--	--

HONDA®

AIRWAVE [J]	2005	2010	HON66T27					SOK / CR	8E				
AMAZE	2010		HON66T14					PH / CR2	46				
AMAZE	2010		HON66MH	HON66TE	HON66FH	Y	Y	PH / CR2	46	Y	P-BOX		
BRIO	2010		HON66T14					PH / CR2	46				
BRIO	2010		HON66MH	HON66TE	HON66FH	Y	Y	PH / CR2	46	Y	P-BOX		
CITY	2002	2007	HON66T6					MEG / CR	48				
CITY	2008	2013	HON66MH	HON66TE	HON66FH	Y	Y	PH / CR2	46	Y	P-BOX		
CITY	2008	2013	HON66T14					PH / CR2	46				
EDIX [J]	2004	2007	HON66T6					MEG / CR	48				
EDIX [J]	2007	2009	HON66T27					SOK / CR	8E				
ELYSION [J]	2004	2013	HON66T14					PH / CR2	46				
ELYSION [J]	2004	2013	HON66MH	HON66TE	HON66FH	Y	Y	PH / CR2	46	Y	P-BOX		
PARTNER [J]	2006	2010	HON66T27					SOK / CR	8E				
STEPWGN	2005	2009	HON66T14					PH / CR2	46				
STEPWGN	2005	2009	HON66MH	HON66TE	HON66FH	Y	Y	PH / CR2	46	Y	P-BOX		
STEPWGN	2005	2009	HON66T27					SOK / CR	8E				

















* The uses of the keys are purely indicative and may be subject to updates and revisions. / Gli utilizzi delle chiavi sono da considerarsi puramente indicativi e possono essere oggetto di aggiornamenti e revisioni. / Die Abbildung und technischen Daten der Schlüssel sind nicht bindend. Silca behält sich Änderungen am Produkt, die zur Verbesserung beitragen, vor. / Les usages des clés sont purement indicatifs; ils peuvent être mis à jour et revus. / Los usos de las llaves deben considerarse puramente indicativos y pueden ser objeto de actualizaciones y revisiones. / As utilizações das chaves devem ser consideradas puramente indicativas e podem ser objecto de actualizações e revisões.

© Registered Trademarks. / © Marchi Registrati. / © Eingetragene Marken. / © Marques Déposées. / © Marcas Registradas. / © Marcas Registradas.



Car Keys Guide / Guida Chiavi Auto / Marktführer für Autoschlüssel / Guide Clés pour Voitures
 Guía Llaves para Coches / Guia Chaves para Carros

New Updates

1	2	2a	3	3a	3b	E1+E2		6	42+71	72	43 44a	12	15
						GTI COMPATIBLE							
CAR MAKE MODEL	FROM	TO	SILCA REF.	SILCA REF.	SILCA REF.	COPY	GEN.	TRANSP. TYPE	FAST COPY PLUS RW4 PLUS FAST COPY / RW4	FAST COPY PLUS RW4 PLUS	FAST COPY RW4	STP	
													
For more info on the uses of car keys, refer to the Silca Electronic Key Catalogue: 													
JEEP®													
RENEGADE	2014							MEG / CR	48				
RENEGADE	2014		SMART KEY					PH / CR3	49-1C				
MASERATI®													
GRAN SPORT	2004	2007						MEG / CR	48				
GRAN TURISMO	2007	2012						MEG / CR	48				
QUATTROPORTE	2004	2011						MEG / CR	48				
PERODUA®													
KELISA	2001	2007	DH5RT4					TEXAS	4C				
KELISA	2001	2007	DH5RMH	DH5RTE	DH5RFH	Y	Y	TEXAS	4C	Y	P-BOX		
KEMBARA	1998	2008	DH4RT4					TEXAS	4C				
KEMBARA	1998	2008	TOY41RMH	TOY41RTE	TOY41RFH	Y	Y	TEXAS	4C	Y	P-BOX		
KENARI	2001	2009	DH5RT4					TEXAS	4C				
KENARI	2001	2009	DH5RMH	DH5RTE	DH5RFH	Y	Y	TEXAS	4C	Y	P-BOX		
MYVI	2006		TOY41RMH	TOY41RTE	TOY41RFH	Y		TEX / CR	67	Y	P-BOX		
NAUTICA	2007	2010	TOY41RMH	TOY41RTE	TOY41RFH	Y		TEX / CR	67	Y	P-BOX		
VIVA	2007	2014	TOY41RMH	TOY41RTE	TOY41RFH	Y		TEX / CR	67	Y	P-BOX		



See also the "Vehicle Guide Legend"
 Vedi anche la "Legenda Guida Veicoli"
 Siehe auch die "Fahrzeugschlüssel Erläuterung"
 Voir aussi la "Légende Guide Véhicules"
 Véase también la "Leyenda Guía para Vehículos"
 Veja também a "Legenda Guia para Veículos"

* The uses of the keys are purely indicative and may be subject to updates and revisions. / Gli utilizzi delle chiavi sono da considerarsi puramente indicativi e possono essere oggetto di aggiornamenti e revisioni. / Die Abbildung und technischen Daten der Schlüssel sind nicht bindend. Silca behält sich Änderungen am Produkt, die zur Verbesserung beitragen, vor. / Les usages des clés sont purement indicatifs; ils peuvent être mis à jour et revus. / Los usos de las llaves deben considerarse puramente indicativos y pueden ser objeto de actualizaciones y revisiones. / As utilizações das chaves devem ser consideradas puramente indicativas e podem ser objecto de actualizações e revisões.

© Registered Trademarks. / © Marchi Registrati. / © Eingetragene Marken. / © Marques Déposées. / © Marcas Registradas. / © Marcas Registradas.



Silca attends major European fairs

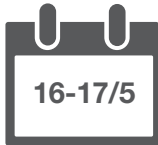

MLA London Region Exhibition

Mercure Hotel Watford
Watford, Hertfordshire
UNITED KINGDOM

MLA London Region Exhibition

Silca is attending the London Region Exhibition organised by the Master Locksmiths Association, the largest and longest established locksmiths organisation in the UK.

The fair focuses in particular on electronic key machines, including Unocode 399 Plus and Evo, Futura One, Triax Quattro and Idea. A range of mechanical key cutting machines, the RW4 Plus cloning device and the Air₄ residential remotes will also be on the show and available for visitors who want to test them and try them hands-on.

We are looking forward to seeing you at our booth.

> locksmiths.co.uk



ELF Convention

The Grand Hotel
Malahide, North Dublin
IRELAND

ELF Convention

Silca is participating in the annual European Locksmith Federation convention, taking place this year in Dublin, Ireland.

Proud sponsor of the exhibition, Silca is going to hold a seminar on international auto locksmithing, a profitable business with great growth potential. To provide its customers with the right tools to tackle this interesting market, Silca has developed a comprehensive range of products, including the recently added car key programmers by Advanced Diagnostics, showcased for the first time at the 2015 ELF convention.

Visit our stand to discover the entire Silca Automotive Solution.

> elf2015.com



Ferroforma concurrent event

Hotel Novotel Bilbao Exhibition Centre
Barakaldo, Bilbao
SPAIN

Silca Open House

If you're attending Ferroforma, you might as well stop by at the open house organised by Silca at the Hotel Novotel, opposite the Bilbao Exhibition Centre.

In this remarkable setting, Silca is going to present a new range of car key programming devices designed and engineered by Advanced Diagnostics, worldwide leading provider of automotive key programming solutions, along with an extensive array of products, including the Empty Shells, Futura key cutting machine and the Air₄ residential remotes.

Come test first-hand our products and attend one of the many practical courses held every day during the event.

> silca.es



Silca Key Programs

Update 1/2015 - SKP Vers. 20.6.2.xx

UPDATE 1/2015

New Silca Key Programs 1/2015 Update for all WEB and DVD subscribers available on the "News" section of Silca Key Programs.

Discover all the updates for Silca Code Program, Silca Triax and Quattrocode Program.

AGGIORNAMENTO 1/2015

Nuovo Aggiornamento Silca Key Programs 1/2015 per tutti gli abbonati WEB e DVD consultabile nella sezione "Novità" di Silca Key Programs.

Scopri tutti gli aggiornamenti per Silca Code Program, Silca Triax e Quattrocode Program.

AKTUALISIERUNG 1/2015

Neue Aktualisierung Silca Key Programs 1/2015 für alle WEB und DVD Abonnenten ist in der Sektion "Neuheiten" des Silca Key Programs verfügbar.

Entdecken Sie die Aktualisierungen für Silca Code Program, Silca Triax und Quattrocode Program.

MISE À JOUR 1/2015

Nouvelle mise à jour Silca Key Programs 1/2015 pour tous les abonnés WEB et DVD disponible dans la section "Nouveautés" de Silca Key Programs.

Découvrez toutes les mises à jour pour Silca Code Program, Silca Triax et Quattrocode Program.

ACTUALIZACIÓN 1/2015

Nueva actualización Silca Key Programs 1/2015 para todos los abonados WEB y DVD disponible en la sección "Novedades" de Silca Key Programs.

Descubra todas las actualizaciones para Silca Code Program, Silca Triax y Quattrocode Program.

ATUALIZAÇÃO 1/2015

Nova atualização Silca Key Programs 1/2015 para todos o assinantes WEB e DVD disponível na seção "Novidades" de Silca Key Programs.

Descubra todas as atualizações para Silca Code Program, Silca Triax e Quattrocode Program.

> [More info on all Silca websites](#)

SILCA CODE PROGRAM

Data Update with 6 new cutting cards

SKP Vers. 20.6.2.xx



Unocode 199

Data update with 6 new cutting cards. / Aggiornamento dati con 6 nuove schede. / Datenaktualisierung mit 6 neuen Karten. / Mise à jour des données avec 6 nouvelles fiches. / Actualización datos con 6 fichas nuevas. / Atualização de dados com 6 fichas novas.

New items include: / Tra le novità: / Unter den Neuheiten: / Parmi les nouveautés: / Entre las novedades: / Entre as novidades:



Unocode 299/399

- Chicago®
- Sargent® (DG1)
- Sargent® (DG2-DG3)
- Piaggio® Cycles (Vespa)
- Avocet® (ATK)
- Weslock®



Unocode 399 Evo



Update the software on: / Aggiornare il software di: / Aktualisierung der Software von: / Mettre à jour le logiciel de: / Actualizar el software de: / Atualizar o software de: UC199/UC299/UC399/UC399 EVO.

SILCA TRIAX - QUATTROCODE PROGRAM

Data Update with 6 new cutting cards

SKP Vers. 20.6.2.xx



Triax Quattro /
Triax e-code

Data update with 6 new series. / Aggiornamento dati con 6 nuove serie. / Daten-Aktualisierung mit 6 neuen Serien. / Mise à jour des données avec 6 nouvelles séries. / Actualización datos con 6 series nuevas. / Atualização de dados com 6 séries novas.

New items include: / Tra le novità: / Unter den Neuheiten: / Parmi les nouveautés: / Entre las novedades: / Entre as novidades:

- Chairo® (CHAIR0 118 (6P))
- Duro® (DURO 280/50 (6+6))
- Keso® (Keso Casa)
- Huf® (Bmw (2T-8W))
- Securystar® (NEW STAR GUARD)
- Securystar® (PRO STAR-MOBILE CODE)



Quattrocode



Update the software on: / Aggiornare il software di: / Aktualisierung der Software von: / Mettre à jour le logiciel de: / Actualizar el software de: / Atualizar o software de: TRIAX e-code, TRIAX QUATTRO.

SILCA FUTURA PROGRAM 1/2015

Data Update with new main series

FUTURA Vers. 2.10.0 - db 1.25
FUTURA app Vers. 1.17



Futura

Data update with new main series. / Aggiornamento dati con nuove serie principali.
/ Datenaktualisierung mit neuen Hauptserien. / Mise à jour des données avec nouvelles séries principales. / Actualización de datos con nuevas series principales. / Atualização de dados com novas séries principais.

- Honda® (Honda Emergency Key (2T-6W))
- Spider® (SPIDER (5+5+5))
- Chairo® (CHAIRO 118 (6P))
- Duro® (DURO 280/50 (6+6))
- Lince® (Lince XA, XB, ...)
- Huf® (Bmw (2T-8W))
- Dom® (Dom IXDAS (Prof.138) (5P))
- Dom® (Dom IXDAS (Prof.138) (5+6+6))
- Dom® (Dom IXDAS (Prof.138) (Precoded key only))
- Dom® (Dom IXGamma (Prf.154) (5+3+7))
- Mauer® (Mauer_NW4 (5P - 2T-5W))
- Chicago® IX6SR E (prof. 129/130/241) MK
- Sargent® (DG1)
- Sargent® (DG2-DG3)
- Piaggio Cycles® (Vespa)
- Avocet® (ATK)
- Weslock®

® are registered trademarks. / sono marchi registrati. / sind eingetragene Marken. / sont des marques déposées. / son marcas registradas. / são marcas registradas.

SILCA FUTURA PROGRAM 1/2015

New Functions

FUTURA Vers. 2.10.0 - db 1.25
FUTURA app Vers. 1.17

New Functions / Nuove Funzioni / Neue Funktionen / Nouvelles Fonctions / Nuevas Funciones / Novas Funções

 - New **“User code table import” function accessible from “Settings”=> “User series”**. This new function allows users to import a code table in the XML-Keso or csv format to create a new user series.

- New **“Change dimensions” function**. For all edge symmetrical keys, it is now possible to view dimensions in two ways: depths referred to the middle of the key or depths referred to the edge of the key.
- Improved the **“Queue of jobs” function**.

 - Nuova funzione **“Importazione tabella utente” accessibile da “Impostazioni => Serie Utente”**.

Questa funzione permette all'utente di importare una tabella di codici in formato XML-Keso o csv creando una nuova serie utente.

- Nuova funzione **“Visualizzazione quote”**. Nella finestra della scheda, per chiavi piatte simmetriche, è possibile scegliere la visualizzazione delle profondità della scheda in due modi : profondità riferite all'asse della chiave, profondità riferite al dorso della chiave.
- Migliorata la gestione della funzione **“Coda di lavoro”**.



Remember to update the Silca.apk after installing the Software update (see the on board Instructions Manual - Ch. APP UPDATE (apk)).



Ricordarsi di aggiornare il Silca.apk dopo l'installazione dell'aggiornamento (vedi istruzioni nel Manuale d'uso - Cap. AGGIORNAMENTO APP (apk)).

SILCA FUTURA PROGRAM 1/2015 New Functions

FUTURA Vers. 2.10.0 - db 1.25 FUTURA app Vers. 1.17

New Functions / Nuove Funzioni / Neue Funktionen / Nouvelles Fonctions / Nuevas Funciones / Novas Funções

- Neue **"Benutzercode-Tabellen-Funktion"** Funktion einstellbar in **"Einstellungen"** => **"Benutzer-Serie"**.

Diese neue Funktion ermöglicht es dem Benutzer eine Tabelle im XML-Keso- oder csv-Format zu erstellen, um eine neue Benutzerserie zu kreieren.

- Neue **"Maßüberprüfung"** Funktion. Für alle beidseitig eingeschnitten Schlüssel ist es jetzt möglich, zwischen zwei verschiedenen Funktionen zu wählen.
- Verbesserte Funktion **"Warteschlange der Aufträge"**.



Erinnern Sie sich die Silca apk nach der Installation des Updates zu aktualisieren (siehe Anleitungen des Betriebs-Handbuches - Kap. UPDATE DER APP (apk)).

- Nouvelle fonction **"User code table import"** (Import de tables de codes de l'utilisateur) accessible via la fonction **"Paramètres => Séries utilisateur"**. Cette nouvelle fonction permet aux utilisateurs d'importer une table de codes au format XML-Keso ou CSV pour créer une nouvelle série de codes.

- Nouvelle fonction **"Change dimensions"** (Changer les dimensions). Pour toutes les doubles tailles symétriques, il est maintenant possible de visualiser les dimensions de deux manières différentes: profondeurs par rapport au milieu de la clé ou profondeurs par rapport au bord de la clé.
- Amélioration de la fonction **"File d'attente des tâches"**.



Mettre à jour Silca.apk après l'installation de la mise à jour (voir instructions dans le Mode d'Emploi - Chap. MISE À JOUR APP (apk)).

- Nueva función **"Importación de tablas de códigos"** función accesible desde **"Configuración"** => **"series usuario"**. Esta nueva función permite a los usuarios importar una tabla de códigos en el formato csv o XML-Keso o para crear una nueva serie de usuarios.

- Nueva función **"Cambio de cotas"**. Para todas las llaves doble serreta de automoción, ahora es posible ver las cotas de dos maneras: Profundidades relativas a la mitad de la llave o profundidades relativas a la llave en bruto.
- Mejora en la función **"cola de trabajo"**.



Se recuerda que Silca.apk se ha de actualizar tras instalar la actualización (véanse las instrucciones del Manual de uso - Cap. ACTUALIZACIÓN DE LA APP (apk)).

- Nova função **"Importação tabela utilizador"** com acesso de **"Programações => Série Utilizador"**. Esta função permite ao utilizador importar uma tabela de códigos em formato XML-Keso ou csv criando uma nova série utilizador.

- Nova função **"Visualização cotas"**. Na janela da ficha, para chaves planas simétricas, é possível escolher a visualização da profundidade da ficha de duas maneiras: profundidades referidas ao eixo da chave, profundidades referidas ao dorso da chave.
- Foi melhorada a gestão da função **"Lista de trabalho"**.

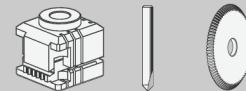

Lembrar de atualizar o Silca.apk após a instalação da atualização (ver as instruções no Manual de Utilização - Cap. ATUALIZAÇÃO APP (apk)).

Accessories / Accessori / Zubehör / Accessoires / Accesorios / Acessórios

FOR:
PER:

CES (D)

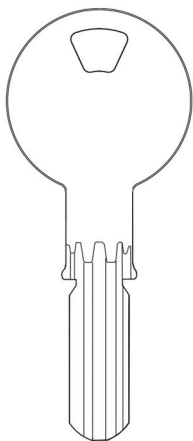

(WSM NEW)

System protected by a password issued by Silca on receipt of authorization.

Sistema protetto da password rilasciata da Silca a fronte di autorizzazione.

System geschützt durch von Silca geliefertes Password auf Genehmigung.

Système protégé par un password qui est émis par Silca sur autorisation.

Sistema protegido por password que expide Silca contra autorización.

Sistema protegido por uma password emitida por Silca contra a autorização.



FUTURA

> SW Futura 2.10

STANDARD



D943253ZR

01J Jaw
Ganascia 01J
01J Backe
Mâchoire 01J
Quijada 01J
Garra 01J

OPTIONAL



D943254ZR

02J Jaw
Ganascia 02J
02J Backe
Mâchoire 02J
Quijada 02J
Garra 02J

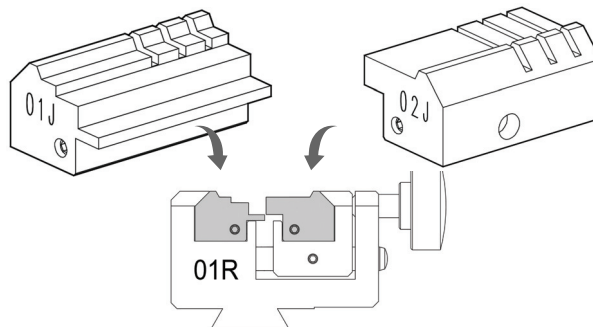

OPTIONAL



D744510ZB

Cutter 11D
Fresa 11D
Fräser 11D
Fraise 11D
Fresa 11D
Fresa 11D

Delivery time MAY 2015
Disponibilità MAGGIO 2015
Lieferbar MAI 2015
Disponibilité MAI 2015
Disponibilidad MAYO 2015
Disponibilidade MAIO 2015

FOR:
PER:

DOM (D)

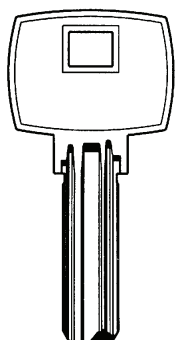

IXGAMMA
(prof. 154)

System protected by a password issued by Silca on receipt of authorization.

Sistema protetto da password rilasciata da Silca a fronte di autorizzazione.

System geschützt durch von Silca geliefertes Password auf Genehmigung.

Système protégé par un password qui est émis par Silca sur autorisation.

Sistema protegido por password que expide Silca contra autorización.

Sistema protegido por uma password emitida por Silca contra a autorização.



FUTURA

> SW Futura 2.10

OPTIONAL



D744499ZB

46J Jaw
Ganascia 46J
46J Backe
Mâchoire 46J
Quijada 46J
Garra 46J

OPTIONAL



D744497ZB

45J Jaw
Ganascia 45J
45J Backe
Mâchoire 45J
Quijada 45J
Garra 45J

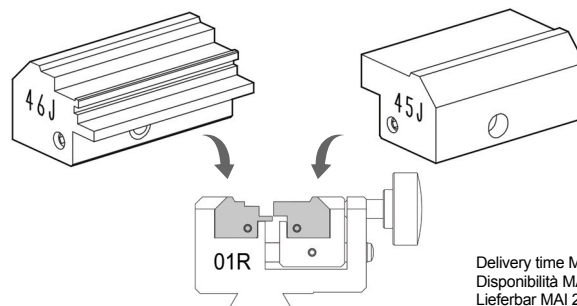

OPTIONAL



D744508ZB

Cutter 09D
Fresa 09D
Fräser 09D
Fraise 09D
Fresa 09D
Fresa 09D

Delivery time MAY 2015
Disponibilità MAGGIO 2015
Lieferbar MAI 2015
Disponibilité MAI 2015
Disponibilidad MAYO 2015
Disponibilidade MAIO 2015

FOR:
PER:

HONDA (J)

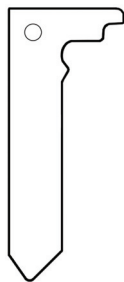

(N-BOX - N-ONE - N-VAGON)
Emergency key



FUTURA

> SW Futura 2.10

OPTIONAL



NEW

D745037ZB

52J Jaw
Ganascia 52J
52J Backe
Mâchoire 52J
Quijada 52J
Garra 52J

OPTIONAL



NEW

D745039ZB

53J Jaw
Ganascia 53J
53J Backe
Mâchoire 53J
Quijada 53J
Garra 53J

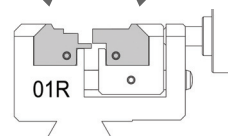
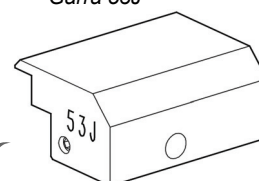
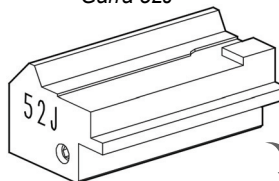

Delivery time MAY 2015
Disponibilità MAGGIO 2015
Lieferbar MAI 2015
Disponibilit  MAI 2015
Disponibilidad MAYO 2015
Disponibilidade MAIO 2015

STANDARD



D742606ZB

Cutter 01L
Fresa 01L
Fr ser 01L
Fraise 01L
Fresa 01L
Fresa 01L

FOR:
PER:

MAUER (BG)

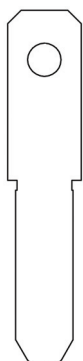

(NW4)



FUTURA

> SW Futura 2.10

OPTIONAL



NEW

D745192ZB

54J Jaw
Ganascia 54J
54J Backe
M choire 54J
Quijada 54J
Garra 54J

OPTIONAL



NEW

D745194ZB

55J Jaw
Ganascia 55J
55J Backe
M choire 55J
Quijada 55J
Garra 55J

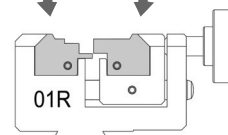
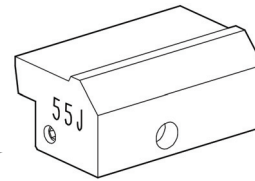
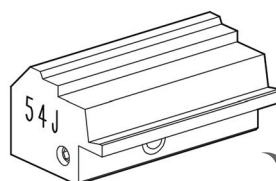

Delivery time MAY 2015
Disponibilit  MAGGIO 2015
Lieferbar MAI 2015
Disponibilit  MAI 2015
Disponibilidad MAYO 2015
Disponibilidade MAIO 2015

OPTIONAL



D743673ZB

Cutter 02D
Fresa 02D
Fr ser 02D
Fraise 02D
Fresa 02D
Fresa 02D



SILCA NEWS 06/15

ALL THE NEW KEYS, AUTOMOTIVE SOLUTIONS, KEY CUTTING MACHINES, SOFTWARE UPDATES AND MUCH MORE

Contents

New Keys	1, 2, 3
Empty Shells	4
Vehicle Keys Guide	5, 6, 7
Key Machine Optional Accessories	8, 9
MySilca App	10, 11, 12
Silca Events	13













New Keys / Chiavi Nuove / Neue Schlüssel / Nouvelles Clés / Llaves Nuevas / Chaves Nuevas

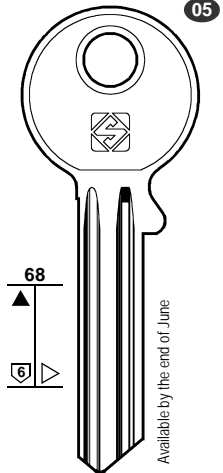

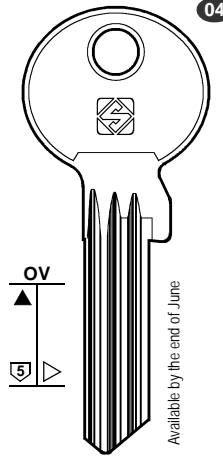

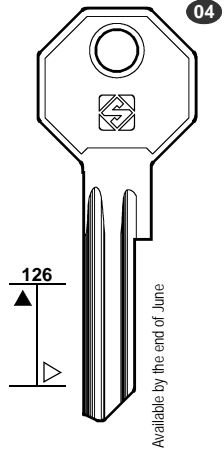

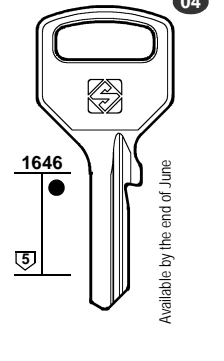

FOR: PER:	ABUS	AGE	ARROW	BEST	FOR / PER		
	<p>AB88X</p>	<p>AGE6</p>	<p>AW22 1D AW23 1C</p>	<p>BES16 Q BES17 R</p>	ABUS (D) AGE (J) ARROW (USA) BEST (USA) BURG (D) CES (D)		
FOR: PER:	BURG	CES					
	<p>BUR61R</p>		CE17W25	CE17W34	CE17X23	CE17X32	CE17X41
		CE17W26	CE17W35	CE17X24	CE17X33	CE17X42	
		CE17W27	CE17W36	CE17X25	CE17X34		
		CE17W28	CE17W37	CE17X26	CE17X35		
		CE17W29	CE17W38	CE17X27	CE17X36		
		CE17W23	CE17W30	CE17X28	CE17X37		
		CE17W24	CE17W31	CE17X29	CE17X38		
		CE17W32	CE17W41	CE17X30	CE17X39		
		CE17W33	CE17W42	CE17X31	CE17X40		

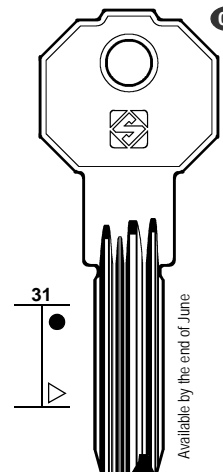
01
 COMMERCIAL GROUP
 GRUPPO COMMERCIALE
 PREISEGRUPPE
 GROUPE COMMERCIAL
 GRUPO COMMERCIAL
 GRUPO COMERCIAL

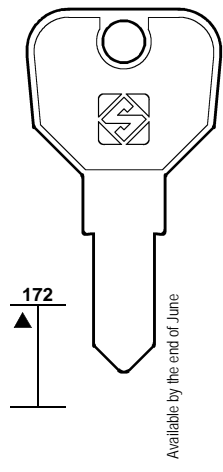
www.silca.biz

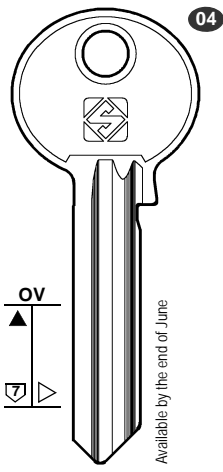
FOR / PER
CES (D)
CORBIN (I)
DOM (D)
LOB (PL)
PREFER (IT)
ROYAL (RC/TW)
RUKO (DK)

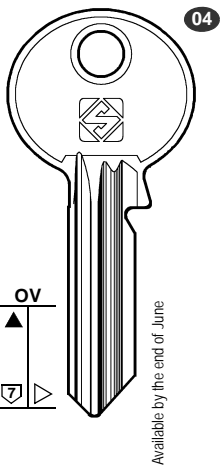







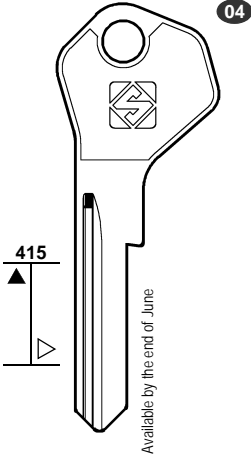

FOR: PER:	CES	CORBIN	DOM	LOB
	 <p>Available by the end of June</p>  <p>CE149</p>	 <p>Available by the end of June</p>  <p>CB106</p>	 <p>Available by the end of June</p>  <p>DM155</p>	 <p>Available by the end of June</p>  <p>LOB11R</p>

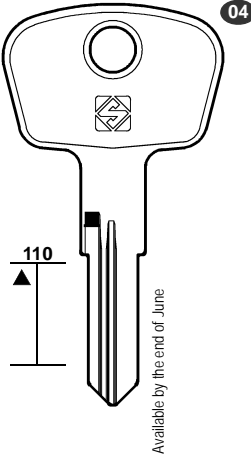
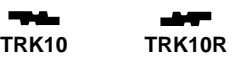
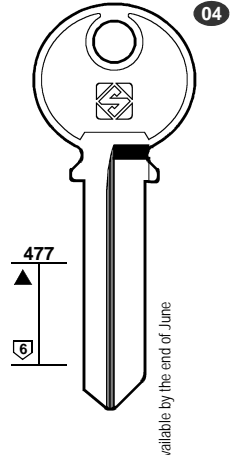
FOR: PER:	PREFER	ROYAL	RUKO	RUKO
	 <p>Available by the end of June</p>  <p>PF21</p>	 <p>Available by the end of June</p>  <p>ROY1</p>	 <p>Available by the end of June</p>  <p>RU29R GK</p>	 <p>Available by the end of June</p>  <p>RU30 TL</p>

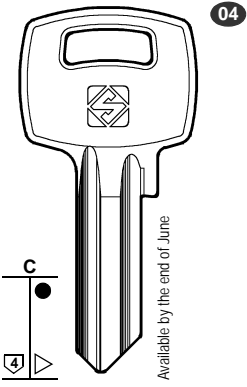
01
 COMMERCIAL GROUP
 GRUPPO COMMERCIALE
 PREISEGRUPPE
 GROUPE COMMERCIAL
 GRUPO COMMERCIAL
 GRUPO COMMERCIAL

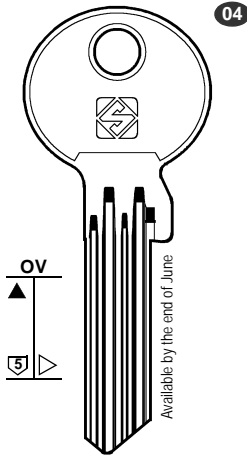
www.silca.biz

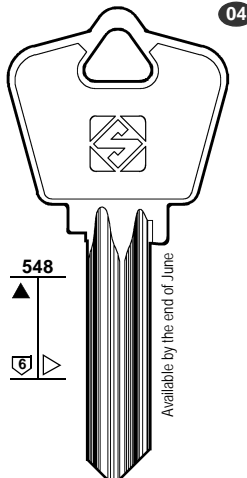

FOR: PER: SQUIRE & SONS	TRELOCK	TRI-CIRCLE	FOR / PER
 <p>415</p> <p>Available by the end of June</p>  <p>SQ6R</p>	 <p>110</p> <p>Available by the end of June</p>  <p>TRK10 TRK10R</p>	 <p>477</p> <p>Available by the end of June</p>  <p>TL16R</p>	<p>SQUIRE & SONS (GB)</p> <p>TRELOCK (D)</p> <p>TRI-CIRCLE (RC)</p> <p>VEROFER (RO)</p> <p>WILKA (D)</p> <p>W.M.S. (GB)</p>
FOR: PER: VEROFER	WILKA	W.M.S.	
 <p>C</p> <p>4</p> <p>Available by the end of June</p>  <p>VRF4</p>	 <p>OV</p> <p>5</p> <p>Available by the end of June</p>  <p>WK87X</p>	 <p>548</p> <p>6</p> <p>Available by the end of June</p>  <p>WMS3</p>	<p>01</p> <p>COMMERCIAL GROUP GRUPPO COMMERCIALE PREISEGRUPPE GROUPE COMMERCIAL GRUPO COMMERCIAL GRUPO COMERCIAL</p> <p>www.silca.biz</p>

SILCA EMPTY SHELLS - NEW REFERENCES

Silca Empty Shells: **1 new key reference** to widen the existing range.

Silca Empty Shells: **1 nouvelle référence** clés qui complètent la gamme existante.

Silca Empty Shells: **1 nuova referen-za** chiavi che implementa la gamma già esistente.

Silca Empty Shells: **1 nueva referencia** llaves que completan la gama existente.

Silca Empty Shells: **1 Schlüssel Referenz** die das bestehende Angebot implementieren.

Silca Empty Shells: **1 nova referência** chaves que implementam a gama existente.

Brand	References/Image	Specifications	Vehicle Models*																																																		
CHEVROLET® SUD AMERICA HOLDEN® OPEL®-VAUXHALL®	HURSH2N 	2 Buttons NO battery holder	<table border="1"> <thead> <tr> <th>MODELS</th> <th>YEAR FROM</th> <th>YEAR TO</th> <th>TRANSPONDER TYPE</th> <th>TRP ID</th> </tr> </thead> <tbody> <tr> <td colspan="5">CHEVROLET® SUD AMERICA</td> </tr> <tr> <td>CORSA</td> <td>2000</td> <td>2004</td> <td>PH/CR</td> <td>40</td> </tr> <tr> <td colspan="5">HOLDEN®</td> </tr> <tr> <td>BARINA</td> <td>2000</td> <td>2006</td> <td>PH/CR</td> <td>40</td> </tr> <tr> <td colspan="5">OPEL®-VAUXHALL®</td> </tr> <tr> <td>AGILA</td> <td>2004</td> <td>2008</td> <td>PH/CR</td> <td>40</td> </tr> <tr> <td>CORSA</td> <td>2000</td> <td>2006</td> <td>PH/CR</td> <td>40</td> </tr> <tr> <td>MERIVA</td> <td>2002</td> <td>2010</td> <td>PH/CR</td> <td>40</td> </tr> <tr> <td>TIGRA</td> <td>2004</td> <td>2009</td> <td>PH/CR</td> <td>40</td> </tr> </tbody> </table>	MODELS	YEAR FROM	YEAR TO	TRANSPONDER TYPE	TRP ID	CHEVROLET® SUD AMERICA					CORSA	2000	2004	PH/CR	40	HOLDEN®					BARINA	2000	2006	PH/CR	40	OPEL®-VAUXHALL®					AGILA	2004	2008	PH/CR	40	CORSA	2000	2006	PH/CR	40	MERIVA	2002	2010	PH/CR	40	TIGRA	2004	2009	PH/CR	40
MODELS	YEAR FROM	YEAR TO	TRANSPONDER TYPE	TRP ID																																																	
CHEVROLET® SUD AMERICA																																																					
CORSA	2000	2004	PH/CR	40																																																	
HOLDEN®																																																					
BARINA	2000	2006	PH/CR	40																																																	
OPEL®-VAUXHALL®																																																					
AGILA	2004	2008	PH/CR	40																																																	
CORSA	2000	2006	PH/CR	40																																																	
MERIVA	2002	2010	PH/CR	40																																																	
TIGRA	2004	2009	PH/CR	40																																																	

* The uses of the keys are purely indicative and may be subject to updates and revisions. / Gli utilizzi delle chiavi sono da considerarsi puramente indicativi e possono essere oggetto di aggiornamenti e revisioni. / Die Abbildung und technischen Daten der Schlüssel sind nicht bindend. Silca behält sich Änderungen am Produkt, die zur Verbesserung beitragen, vor. / Les usages des clés sont purement indicatifs; ils peuvent être mis à jour et revus. / Los usos de las llaves deben considerarse puramente indicativos y pueden ser objeto de actualizaciones y revisiones. / As utilizações das chaves devem ser consideradas puramente indicativas e podem ser objecto de actualizações e revisões.

© Registered Trademarks. / © Marchi Registrati. / © Eingetragene Marken. / © Marques Déposées. / © Marcas Registradas. / © Marcas Registradas.

EMPTY KEY SHELLS RANGE

Discover Silca Empty Shells range visiting www.silca.biz and ekc.silca.biz.

Scopri tutta la gamma chiavi Silca Empty Shells collegandoti a www.silca.biz e ekc.silca.biz.

Entdecken sie die Schlüsselpalette Silca Empty Shells auf unseren Websites www.silca.biz und ekc.silca.biz.

Découvrez la notre gamme de clés Silca Empty Shells directement sur notre site www.silca.biz et ekc.silca.biz.

Descubra la gama completa de las llaves Silca Empty Shells visitando www.silca.biz y ekc.silca.biz.

Descubra toda a gama de chaves Silca Empty Shells através dos sítios www.silca.biz e ekc.silca.biz.

EMPTY-SHELLS CATALOGUE Vers. 2 - July 2014

ON LINE ALWAYS UPDATED RANGE

Car Keys Guide / Guida Chiavi Auto / Marktführer für Autoschlüssel / Guide Clés pour Voitures
 Guía Llaves para Coches / Guia Chaves para Carros

New Updates

1	2	2a	3	3a	3b	E1+E2		6	42+71	72	43 44a	12	15
						GTI COMPATIBLE		IGNITION 					
CAR MAKE MODEL	FROM	TO	SILCA REF.	SILCA REF.	SILCA REF.	COPY	GEN.	TRANSP. TYPE	FAST COPY PLUS RW4 PLUS FAST COPY / RW4	FAST COPY PLUS RW4 PLUS	FAST COPY RW4	STP	

For more info on the uses of car keys, refer to the Silca Electronic Key Catalogue:

CHEVROLET® SUD AMERICA

CORSA	2000	2004	HURSH2N					PH / CR	40				
-------	------	------	---------	--	--	--	--	---------	----	--	--	--	--

CITROËN®

C1	2004	2014	VA2RS2					TEX / CR	70				
C1	2004	2014	VA6MH	VA2TE	VA6FH	Y	Y	TEX / CR	70	Y	P-BOX		
C1	2004	2014						TEX / CR	70				
CACTUS	2014		HU83MH	HU83TE	HU83FH	Y	Y	PH / CR2	46	Y	P-BOX		
CACTUS	2014		HU83T14					PH / CR2	46				

FORD® EU

B-MAX	2012							TEX / MA	6E				
C-MAX	2011		SMART KEY					TEX / MA	6E				
ECOSPORT	2013							TEX / MA	6E				
FIESTA	2013		SMART KEY					TEX / MA	6E				
FOCUS	2011		SMART KEY					TEX / MA	6E				
KUGA	2008	2012	HU101MH	HU101TE	HU101FH	Y	Y	TEX / CR	63	Y	P-BOX		
KUGA	2008	2012	HU101T17					TEX / CR	63				
KUGA	2008	2012	SMART KEY					TEX / CR	63				
KUGA	2012		SMART KEY					TEX / MA	6E				
KUGA	2012							TEX / MA	6E				
MONDEO	2011	2014	SMART KEY					TEX / MA	6E				
MONDEO	2011	2014						TEX / MA	6E				
MONDEO	2014		SMART KEY					PH / CR3	47				
S-MAX	2011		SMART KEY					TEX / MA	6E				
TOURNEO CONNECT	2002	2008	FO21MH	FO21TE	FO21FH	Y	Y	TEX / CR	60	Y	P-BOX		
TOURNEO CONNECT	2002	2008	FO21T7					TEX / CR	60				S5
TOURNEO CONNECT	2009	2013	FO21MH	FO21TE	FO21FH	Y	Y	TEX / CR	63	Y	P-BOX		
TOURNEO CONNECT	2009	2013	FO21T17					TEX / CR	63				
TOURNEO CONNECT	2013							TEX / MA	6E				
TOURNEO COURIER	2012							TEX / MA	6E				
TOURNEO CUSTOM	2013							TEX / MA	6E				
TRANSIT	2007	2013	FO21MH	FO21TE	FO21FH	Y	Y	TEX / CR	63	Y	P-BOX		

* The uses of the keys are purely indicative and may be subject to updates and revisions. / Gli utilizzi delle chiavi sono da considerarsi puramente indicativi e possono essere oggetto di aggiornamenti e revisioni. / Die Abbildung und technischen Daten der Schlüssel sind nicht bindend. Silca behält sich Änderungen am Produkt, die zur Verbesserung beitragen, vor. / Les usages des clés sont purement indicatifs; ils peuvent être mis à jour et revus. / Los usos de las llaves deben considerarse puramente indicativos y pueden ser objeto de actualizaciones y revisiones. / As utilizações das chaves devem ser consideradas puramente indicativas e podem ser objecto de actualizações e revisões.

® Registered Trademarks. / ® Marchi Registrati. / ® Eingetragene Marken. / ® Marques Déposées. / ® Marcas Registradas. / ® Marcas Registradas.

Car Keys Guide / Guida Chiavi Auto / Marktführer für Autoschlüssel / Guide Clés pour Voitures
 Guía Llaves para Coches / Guia Chaves para Carros

New Updates

1	2	2a	3	3a	3b	E1+E2		6	42+71	72	43 44a	12	15
						GTI COMPATIBLE		IGNITION 					
CAR MAKE MODEL	FROM	TO	SILCA REF.	SILCA REF.	SILCA REF.	COPY	GEN.	TRANSP. TYPE	FAST COPY PLUS RW4 PLUS FAST COPY / RW4	FAST COPY PLUS RW4 PLUS	FAST COPY RW4	STP	

For more info on the uses of car keys, refer to the Silca Electronic Key Catalogue:

FORD® EU													
TRANSIT	2007	2013	FO21MH	FO21TE	FO21FH	Y	Y	TEX / CR2	6F	Y	P-BOX		
TRANSIT	2007	2013	FO21T17					TEX / CR	63				
TRANSIT	2013							TEX / MA	6E				
TRANSIT CONNECT	2002	2008	FO21MH	FO21TE	FO21FH	Y	Y	TEX / CR	60	Y	P-BOX		
TRANSIT CONNECT	2002	2008	FO21T7					TEX / CR	60				S5
TRANSIT CONNECT	2009	2013	FO21MH	FO21TE	FO21FH	Y	Y	TEX / CR	63	Y	P-BOX		
TRANSIT CONNECT	2009	2013	FO21T17					TEX / CR	63				
TRANSIT CONNECT	2013							TEX / MA	6E				
TRANSIT COURIER	2012							TEX / MA	6E				
TRANSIT CUSTOM	2013							TEX / MA	6E				
HOLDEN®													
BARINA	2000	2006	HURSH2N					PH / CR	40				
MAZDA®													
CX-3	2015		SMART KEY					PH / CR3	47				
DEMIO [J]	2003	2014	MAZ24RMH	MAZ24RTE	MAZ24RFH	Y	Y	TEX / CR	63	Y	P-BOX		
MAZDA 2	2003	2014	MAZ24RMH	MAZ24RTE	MAZ24RFH	Y	Y	TEX / CR	63	Y	P-BOX		
MAZDA 2	2003	2014	MAZ24RT17					TEX / CR	63				
MAZDA 2	2015		SMART KEY					PH / CR3	47				
OPEL®-VAUXHALL®													
AGILA	2004	2008	HURSH2N					PH / CR	40				
CORSA	2000	2006	HURSH2N					PH / CR	40				
MERIVA	2002	2010	HURSH2N					PH / CR	40				
TIGRA	2004	2009	HURSH2N					PH / CR	40				
PEUGEOT®													
107	2005	2014	VA2RS2					TEX / CR	70				
107	2005	2014	VA6MH	VA2TE	VA6FH	Y	Y	TEX / CR	70	Y	P-BOX		
107	2005	2014						TEX / CR	70				
TOYOTA®													
AYGO	2005	2014	VA2RS2					TEX / CR	70				
AYGO	2005	2014	VA6MH	VA2TE	VA6FH	Y	Y	TEX / CR	70	Y	P-BOX		
AYGO	2005	2014						TEX / CR	70				

* The uses of the keys are purely indicative and may be subject to updates and revisions. / Gli utilizzi delle chiavi sono da considerarsi puramente indicativi e possono essere oggetto di aggiornamenti e revisioni. / Die Abbildung und technischen Daten der Schlüssel sind nicht bindend. Silca behält sich Änderungen am Produkt, die zur Verbesserung beitragen, vor. / Les usages des clés sont purement indicatifs; ils peuvent être mis à jour et revus. / Los usos de las llaves deben considerarse puramente indicativos y pueden ser objeto de actualizaciones y revisiones. / As utilizações das chaves devem ser consideradas puramente indicativas e podem ser objeto de actualizações e revisões.

® Registered Trademarks. / ® Marchi Registrati. / ® Eingetragene Marken. / ® Marques Déposées. / ® Marcas Registradas. / ® Marcas Registradas.

**Motorcycle Keys Guide / Guida Chiavi Moto / Marktführer für Motorraderschlüssel
Guide Clés pour Motocyclettes / Guía Llaves para Motocicletas / Guia Chaves para Motocicletas**

New Updates

1	2	2a	3	3a	3b	E1+E2		6	42+71	72	43 44a	12	15
						GTI COMPATIBLE		IGNITION 					
CAR MAKE MODEL	FROM	TO	SILCA REF.	SILCA REF.	SILCA REF.	COPY	GEN.	TRANSP. TYPE	FAST COPY PLUS RW4 PLUS FAST COPY / RW4	FAST COPY PLUS RW4 PLUS	FAST COPY RW4	STP	

For more info on the uses of motorcycles keys, refer to the Silca Electronic Key Catalogue:

YAMAHA®													
FJ-09	2015		YH35RAT22					TEX / CR	69				S12
FJ-09	2015		YH35RMH	YH35RATE	YH35RFH	Y	Y	TEX / CR	69	Y	P-BOX		
FZ-07	2013		YH35RAT22					TEX / CR	69				S12
FZ-07	2013		YH35RMH	YH35RATE	YH35RFH	Y	Y	TEX / CR	69	Y	P-BOX		
FZ-09	2013		YH35RAT22					TEX / CR	69				S12
MT-03	2006	2013	YH35RAT22					TEX / CR	69				S12
MT-03	2006	2013	YH35RMH	YH35RATE	YH35RFH	Y	Y	TEX / CR	69	Y	P-BOX		
MT-07	2013		YH35RAT22					TEX / CR	69				S12
MT-07	2013		YH35RMH	YH35RATE	YH35RFH	Y	Y	TEX / CR	69	Y	P-BOX		
MT-09	2013		YH35RAT22					TEX / CR	69				S12
MT-09	2013		YH35RMH	YH35RATE	YH35RFH	Y	Y	TEX / CR	69	Y	P-BOX		
MT-09 TRACER	2015		YH35RAT22					TEX / CR	69				S12
MT-09 TRACER	2015		YH35RMH	YH35RATE	YH35RFH	Y	Y	TEX / CR	69	Y	P-BOX		
TMAX	2015		SMART KEY					PH / CR3	47				
T-MAX 500	2005	2014	YH35RAT22					TEX / CR	69				S12
T-MAX 500	2005	2014	YH35RMH	YH35RATE	YH35RFH	Y	Y	TEX / CR	69	Y	P-BOX		



IMPORTANT NOTE:

See also the "Vehicle Guide Legend"
 Vedi anche la "Legenda Guida Veicoli"
 Siehe auch die "Fahrzeugschlüssel Erläuterung"
 Voir aussi la "Légende Guide Véhicules"
 Véase también la "Leyenda Guía para Vehículos"
 Veja também a "Legenda Guia para Veículos"

* The uses of the keys are purely indicative and may be subject to updates and revisions. / Gli utilizzi delle chiavi sono da considerarsi puramente indicativi e possono essere oggetto di aggiornamenti e revisioni. / Die Abbildung und technischen Daten der Schlüssel sind nicht bindend. Silca behält sich Änderungen am Produkt, die zur Verbesserung beitragen, vor. / Les usages des clés sont purement indicatifs; ils peuvent être mis à jour et revus. / Los usos de las llaves deben considerarse puramente indicativos y pueden ser objeto de actualizaciones y revisiones. / As utilizações das chaves devem ser consideradas puramente indicativas e podem ser objecto de actualizações e revisões.

© Registered Trademarks. / © Marchi Registrati. / © Eingetragene Marken. / © Marques Déposées. / © Marcas Registradas. / © Marcas Registradas.

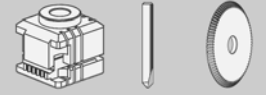

Accessories / Accessori / Zubehör / Accessoires / Accesorios / Acessórios

FOR:
PER:

VIRO (I)



(Palladium)



MATRIX PRO - EVO
MATRIX ONE



MATRIX S - SX - SLX

OPTIONAL

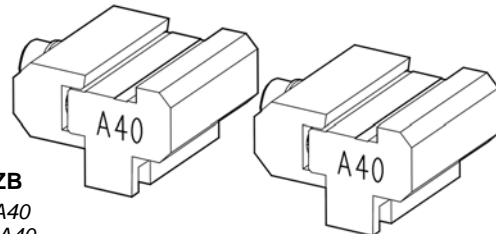

D745653ZB

Adapters A40
Adattatori A40
Adapters A40
Adaptateurs A40
Adaptadores A40
Adaptadores A40

Delivery time JULY 2015
Disponibilità LUGLIO 2015
Lieferbar JULI 2015
Disponibilité JUILLET 2015
Disponibilidad JULIO 2015
Disponibilidade JULHO 2015

OPTIONAL

D740367ZB

Tracer point T39
Tastatore T39
Taster T39
Palpeur T39
Palpador T39
Palpador T39



D740442ZB

Cutter F39
Fresa F39
Fräser F39
Fraise F39
Fresa F39
Fresa F39

FOR:
PER:

BKS (D)

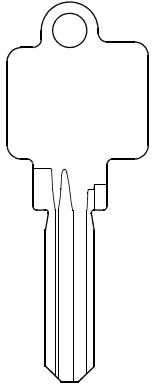

(WS42)



FUTURA

OPTIONAL



D744485ZB

39J Jaw
Ganascia 39J
39J Backe
Mâchoire 39J
Quijada 39J
Garra 39J



OPTIONAL



D744482ZB

38J Jaw
Ganascia 38J
38J Backe
Mâchoire 38J
Quijada 38J
Garra 38J

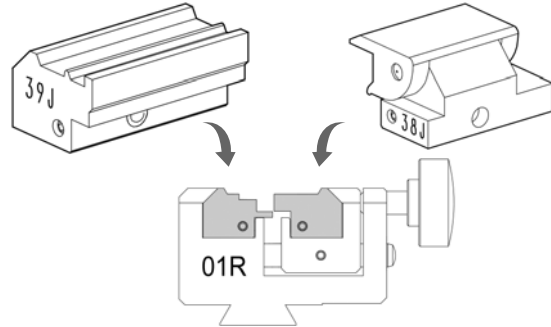

OPTIONAL



D744514ZB

Cutter 08L
Fresa 08L
Fräser 08L
Fraise 08L
Fresa 08L
Fresa 08L

ATTENTION! this information replaces the previous one published on page 10 of the SILCA NEWS nr. 03/2015.

ATTENZIONE! questa informazione sostituisce quanto pubblicato a pag.10 del SILCA NEWS nr. 03/2015.

ACHTUNG! Diese Information ersetzt die vorhergehende auf Seite 10 der SILCA NEWS nr. 03/2015 veröffentlicht.

ATTENTION! cette information remplace la précédente publiée à la page 10 du Silca NEWS nr. 03/2015.

¡ATENCIÓN! esta información sustituye a la publicada anteriormente en la página 10 del SILCA NEWS nr. 03/2015.

ATENÇÃO! esta informação substitui a anterior publicada na página 10 do Silca NEWS n. 03/2015.

FOR:
PER:

BKS (D)

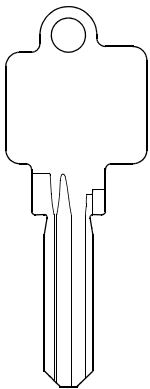

(WS50 MK)



FUTURA

OPTIONAL



D744480ZB

37J Jaw
Ganascia 37J
37J Backe
Mâchoire 37J
Quijada 37J
Garra 37J



OPTIONAL



D744482ZB

38J Jaw
Ganascia 38J
38J Backe
Mâchoire 38J
Quijada 38J
Garra 38J

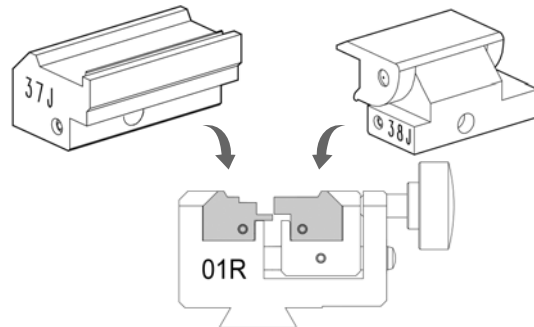

OPTIONAL



D744514ZB

Cutter 08L
Fresa 08L
Fräser 08L
Fraise 08L
Fresa 08L
Fresa 08L

ATTENTION! this information replaces the previous one published on page 10 of the SILCA NEWS nr. 03/2015.

ATTENZIONE! questa informazione sostituisce quanto pubblicato a pag.10 del SILCA NEWS nr. 03/2015.

ACHTUNG! Diese Information ersetzt die vorhergehende auf Seite 10 der SILCA NEWS nr. 03/2015 veröffentlicht.

ATTENTION! cette information remplace la précédente publiée à la page 10 du Silca NEWS nr. 03/2015.

¡ATENCIÓN! esta información sustituye a la publicada anteriormente en la página 10 del SILCA NEWS nr. 03/2015.

ATENÇÃO! esta informação substitui a anterior publicada na página 10 do Silca NEWS n. 03/2015.



MySilca App

The version 1.2 is now online

MySilca App - version 1.2

A new version of MySilca App, optimized also for tablets, has been released on Google Play and App Store for free download.

MySilca has been developed to meet the needs of key cutters and locksmiths worldwide and provide them real time support and updates.

- > Available for Android and iOS systems*.
- > Optimized for tablet and smartphone.
- > Available in English, Italian, German, French, Spanish and Portuguese.
- > Overview of all Silca products, with comprehensive and easy to consult materials, and exclusive technical contents to support you in your daily work.
- > Prompt access to all the necessary information to duplicate a remote with Silca Air⁴, including video tutorials to guide you step-by-step through the procedures.
- > A selected array of key machines features also a search menu to single out the Silca cutters and tracer points needed to copy different key systems.
- > Real time updates through push notifications and immediate access to the electronic key catalogue.

* Minimum software version required: 4.1 for Android - 7.1 for iOS. Compatible with iPhone, iPad and iPod touch. MySilca is optimized for iPhone 5.

MySilca App - versione 1.2

Una nuova versione di MySilca App, ottimizzata anche per tablet, è disponibile e scaricabile gratuitamente da Google Play e App Store.

MySilca è stata sviluppata per fornire aggiornamento e supporto in tempo reale all'attività quotidiana di duplicatori e specialisti in tutto il mondo.

- > Disponibile per i sistemi Android e iOS*.
- > Ottimizzata per tablet e smartphone.
- > Disponibile in italiano, inglese, tedesco, francese, spagnolo e portoghese.
- > Panoramica di tutti i prodotti Silca con contenuti esaustivi e di facile consultazione, ed un'esclusiva documentazione tecnica per fornirti supporto quotidiano.
- > Rapido accesso a tutte le informazioni necessarie a duplicare un radiocomando con Silca Air⁴, fra cui video tutorial che ti guidano passo passo nelle procedure di copia.
- > Una selezionata gamma di duplicatrici è dotata anche di un menu di ricerca per individuare frese e tastatori Silca necessari a copiare diversi sistemi chiavi.
- > Aggiornamenti in tempo reale tramite notifiche push e accesso immediato al catalogo elettronico chiavi.

* Versione software minima richiesta: 4.1 per Android - 7.1 per iOS. Compatibile con iPhone, iPad e iPod touch. MySilca è ottimizzata per iPhone 5.

MySilca App - Version 1.2

Eine neue Version von MySilca App für Tablet-optimiert steht in Google Play und App Store zur Verfügung: herunterladen Sie es kostenlos.

MySilca wurde entwickelt, um ständig aktuelle Informationen und Support in Echtzeit für die alltägliche Arbeit der Schlüsseldienste weltweit zu liefern.

- > Für Android oder iOS* Systeme erhältlich.
- > Für Tablet und Smartphone optimiert.
- > In Deutsch, Englisch, Italienisch, Spanisch, Französisch, und Portugiesisch verfügbar.
- > Überblick aller Silca-Produkte mit ausführlichem Infomaterial, und exklusiven technischen Unterlagen für alltäglichen Support.
- > Leichter Zugriff auf alle für die Kopie von Funkfernbedienungen mit Air⁴ notwendigen Informationen, und auch Tutorfilme, die Sie stufenweise durch den Kopiervorgang führen.
- > Einige Schlüsselkopiermaschinen verfügen auch über ein Menü zur Suche von Silca-fräsern und Tastern, die zum Kopieren von verschiedenen Schlüsselsystemen erforderlich sind.
- > Updates in Echtzeit durch Push-Benachrichtigungen und Sofortzugriff auf den elektronischen Schlüsselkatalog.

* Erforderliche Mindestsoftwareversion: 4.1 für Android - 7.1 für iOS. Kompatibel mit iPhone, iPad und iPod touch. MySilca ist für iPhone 5 optimiert.



MySilca App - The version 1.2 is now online

MySilca App - version 1.2

Une nouvelle version de MySilca App, optimisée pour tablette, est disponible et téléchargeable gratuitement sur Google Play et App Store.

MySilca a été développée pour répondre aux besoins des pros de la reproduction de clés et des serruriers dans le monde entier et pour leur apporter une assistance ainsi que des mises à jour en temps réel.

- > Disponible sur Android et iOS*.
- > Optimisée pour tablette et smartphone.
- > Disponible en français, anglais, italien, allemand, espagnol et portugais.
- > Présentation des produits Silca, avec des contenus exhaustifs et conviviaux, et de la documentation technique exclusive pour vous apporter une aide quotidienne.
- > Accès rapide à toutes les informations nécessaires à la reproduction d'une télécommande avec Air4, et aussi à des tutoriels vidéo qui vous guideront dans les procédures de copie.
- > Un éventail sélectionné de machines intègre également un menu de recherche pour trouver les fraises et les palpeurs Silca qui sont nécessaires à la reproduction de différents systèmes de clé.
- > Mises à jour en temps réel avec des notifications push et accès immédiat au catalogue électronique clés.

* Version de logiciel minimum requise : 4.1 pour Android - 7.1 pour iOS. Compatible avec iPhone, iPad et iPod touch. MySilca est optimisée pour une utilisation sur iPhone 5.

MySilca App - versión 1.2

Una nueva versión de MySilca App, optimizada para tabletas, está disponible y descargable gratis desde Google Play y App Store.

MySilca ha sido desarrollado para cubrir las necesidades de los duplicadores de llaves y cerrajeros profesionales a nivel mundial, y proporcionarles actualizaciones y soporte en tiempo real.

- > Disponible en Android e iOS*.
- > Optimizada para tablet y smartphone.
- > Disponible en español, inglés, italiano, alemán, francés y portugués.
- > Visión global de todos los productos Silca con materiales exhaustivos, y una exclusiva documentación técnica, para proporcionarle un soporte diario.
- > Acceso rápido a toda la información necesaria para duplicar un mando con Air4, y también vídeos tutoriales que le guían paso a paso en los procedimientos de copia.
- > Dispone de un menú de búsqueda para determinar la fresa y palpador Silca indicado de acuerdo a un grupo de máquinas específicas para duplicar diferentes sistemas de cerraduras.
- > Actualizaciones en tiempo real con notificaciones push y acceso inmediato al catálogo electrónico llaves.

* Mínima versión de software necesaria: 4.1 para Android - 7.1 para iOS. Compatible con iPhone, iPad y iPod touch. MySilca es compatible con iPhone 5.

MySilca App - versão 1.2

Uma nova versão da App MySilca, otimizada para tablet, está disponível como um download gratuito de Google Play e App Store.

MySilca foi desenvolvida para fornecer atualização e suporte em tempo real à actividade quotidiana dos duplicadores e dos profissionais da segurança em todo o mundo.

- > Disponível para os sistemas Android e iOS*.
- > Optimizada para tablet e smartphone.
- > Disponível em português, inglês, italiano, alemão, francês, e espanhol.
- > Panorâmica dos todos os produtos Silca com materiais exhaustivos, e uma documentação técnica exclusiva para proporcionar um suporte quotidiano.
- > Acesso rápido a todas as informações necessárias para duplicar um rádio controle com Air4, e também vídeo tutoriais que acompanha o utilizador passo-a-passo nos procedimentos de cópia.
- > Algumas duplicadoras estão providas de um menu de pesquisa para individualizar fresas e palpadores Silca necessários para copiar diferentes sistemas chave.
- > Atualizações em tempo real com notificações push e acesso imediato ao catálogo eletrônico chaves.

* Versão de software mínima necessária: 4.1 para Android - 7.1 para iOS. Compatível com iPhone, iPad e iPod touch. MySilca é otimizada para iPhone 5.





Vehicle Key Finder Pro

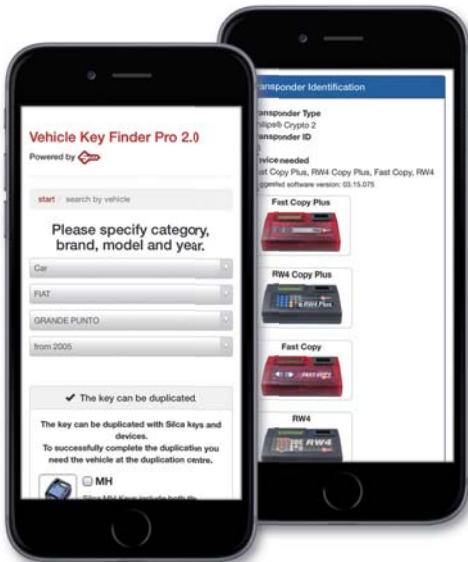

UK This tool has been designed to facilitate your search of automotive keys starting from either a Silca reference or a vehicle make and model. VKF Pro provides you with all the information necessary to copy a vehicle key, such as what transponder and cloning device you need, what key machines you can use to cut the blade and with the aid of what clamps and software cards.

DE Dieses Tool vereinfacht Ihre Suche des Fahrzeugschlüssels durch eine Silca-Referenz oder die Fahrzeugmarke und Modell. VKF Pro liefert alle zum Schlüssel-Kopieren erforderlichen Informationen, z.B. welchen Transponder und welches Gerät Sie verwenden sollten, welche Kopiermaschine eignet sich besser für den Einschnitt von der Schlüsselstange und mit welchen Klemmen und Softwarekarten.

ES Esta herramienta ha sido diseñada para facilitar la búsqueda de llaves de coche ya sea utilizando la referencia Silca o marca y modelo del coche. VKF Pro, disponible exclusivamente en MySilca, te proporciona toda la información necesaria para copiar una llave de coche, tal como el transponder, dispositivo de clonación, duplicadora de llaves para cortar el perfil, mordazas y fichas a utilizar.

IT Questo strumento è pensato per semplificare la tua ricerca di chiavi automotive a partire da una referenza Silca o dalla marca e dal modello di un veicolo. VKF Pro fornisce tutte le informazioni necessarie a copiare una chiave veicolo, come quale transponder e dispositivo di clonazione utilizzare, quale duplicatrice scegliere per cifrare la canna della chiave e con l'ausilio di quali morsetti e schede software.

FR Cet outil a été conçu pour faciliter votre recherche de clés automobiles à partir d'une référence Silca ou d'une marque et d'un modèle de véhicule. VKF Pro vous donne toutes les informations nécessaires à la reproduction d'une clé de véhicule, telles que le type de transpondeur et l'appareil de reproduction dont vous avez besoin, les machines que vous pouvez utiliser pour tailler une lame et les serrages et logiciels qui peuvent vous aider.

PT Este instrumento é pensado para simplificar a pesquisa de chaves automóveis a partir de uma referência Silca ou da marca e do modelo de um veículo. VKF Pro fornece todas as informações necessárias para copiar uma chave de veículo, como qual transponder e qual dispositivo de clonação utilizar, qual máquina duplicadora escolher para cortar a cana da chave e com o auxílio de quais mordentes e fichas software.



Where you can download MySilca App

Download MySilca from / Scarica MySilca da / Herunterladen Sie MySilca von / Téléchargez MySilca sur / Descargue MySilca de / Baixe MySilca de

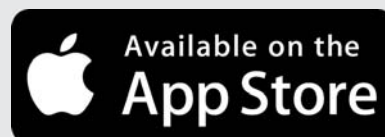



ELF Convention 2015

 The European Locksmith Federation Convention, which took place this year in Malahide, Dublin, Ireland, was the perfect showcase for introducing Silca latest innovations to boost its already extensive range of automotive products. Car key programmers AD100 Pro and MVP Pro, designed and engineered by Advanced Diagnostics, were presented during the three-day event, drawing interest and appraisal from the many key cutters and locksmiths working in the vehicle key duplication business.

 La convention annuale della European Locksmith Federation, tenutasi quest'anno a Malahide, Dublino, Irlanda, è stata la cornice perfetta per introdurre nel mercato le ultime innovazioni Silca in fatto di prodotti automotive. I dispositivi di programmazione chiavi auto, AD100 Pro e MVP Pro, progettati e realizzati da Advanced Diagnostics, sono stati presentati all'evento, catalizzando l'interesse e l'apprezzamento dei molti duplicatori e specialisti operanti nel settore della duplicazione chiavi veicolo.

 Die jährliche Tagung der European Locksmith Federation, die dieses Jahr in Malahide, Dublin, Irland stattgefunden hat, war der ideale Rahmen für die Markteinführung der Neuheiten, die Silca für den Bereich Automotive entwickelt hat. Bei der Veranstaltung wurden die von Advanced Diagnostic konzipierten und verwirklichten Produkte zur Programmierung von Fahrzeugschlüsseln, AD100 Pro und MVP Pro vorgestellt, die bei den zahlreichen Fachleuten der Fahrzeugschlüsseldienste sehr gut angekommen sind und großes Interesse geweckt haben.

 La convention annuelle de la European Locksmith Federation s'est tenue cette année à Malahide, Dublin (Irlande), cadre parfait pour introduire sur le marché les dernières nouveautés Silca en matière de produits automobile. Les dispositifs de programmation clés auto, AD100 Pro et MVP Pro, projetés et réalisés par Advanced Diagnostics, ont été présentés en cette occasion et ont catalysé l'intérêt et l'appréciation des nombreux spécialistes du secteur de la reproduction de clés de véhicules.

 El congreso anual de la European Locksmith Federation, celebrado este año en Malahide, Dublín, Irlanda, fue el marco perfecto para introducir en el mercado las últimas innovaciones de Silca en términos de productos para la automoción. Los dispositivos de programación para llaves de coche, AD100 Pro y MVP Pro, diseñados y realizados por Advanced Diagnostics, se presentaron en el evento y despertaron el interés y fueron apreciados por los numerosos duplicadores y especialistas que trabajan en la duplicación de llaves para vehículos.

 A convenção anual da European Locksmith Federation, que este ano teve lugar em Malahide, Dublin, Irlanda, foi o ambiente perfeito para apresentar no mercado as últimas inovações da Silca no campo dos produtos automotive. Os dispositivos de programação de chaves automóvel, AD100 Pro e MVP Pro, projectados e fabricados pela Advanced Diagnostics, foram apresentados no evento, catalisando o interesse e a apreciação dos muitos profissionais da duplicação e especialistas que trabalham no sector da duplicação de chaves para veículo.



SILCA NEWS 07/15

ALL THE NEW KEYS, AUTOMOTIVE SOLUTIONS, KEY CUTTING MACHINES, SOFTWARE UPDATES AND MUCH MORE

Contents

<u>New Keys</u>	1,2
<u>Empty Shells</u>	3
<u>Vehicle Keys Guide</u>	4
<u>Advanced Diagnostics Devices</u>	5,6,7
<u>Advanced Diagnostics Software</u>	8,9,10,11,12,13
<u>Silca Key Programs Update</u>	14, 15, 16, 17, 18
<u>Silca Futura Program Update</u>	19





New Keys / Chiavi Nuove / Neue Schlüssel / Nouvelles Clés / Llaves Nuevas / Chaves Nuevas

FOR: PER:	ABUS	AZBE	BRISANT	CES	FOR / PER
	<p>10</p> <p>P326</p> <p>5</p> <p>Available by the end of July</p> <p>AB58AP</p> <p>BUFFO</p>	<p>04</p> <p>A</p> <p>594</p> <p>Available by the end of July</p> <p>AZ2X</p> <p>A 12345678</p>	<p>06</p> <p>1219</p> <p>Available by the end of July</p> <p>BRS1R</p>	<p>05</p> <p>68</p> <p>Available by the end of July</p> <p>CE38W23</p> <p>CE38W42</p> <p>CE38W41</p> <p>CE38W40</p>	ABUS (D) BUFFO AZBE (E) BRISANT (GB) BUFFO (GR) ABUS CES (D) POTENT (I) ZOO (GB)
FOR: PER:	CES	POTENT	ZOO		
	<p>05</p> <p>1056</p> <p>Available by the end of July</p> <p>CE150</p>	<p>06</p> <p>P413</p> <p>Available by the end of July</p> <p>PT6RP</p>	<p>05</p> <p>1655</p> <p>Available by the end of July</p> <p>Z01</p>		
					<p>01</p> <p>COMMERCIAL GROUP GRUPPO COMMERCIALE PREISEGRUPPE GROUPE COMMERCIAL GRUPO COMMERCIAL GRUPO COMERCIAL</p> <p>www.silca.biz</p>

FOR / PER
JOHN DEERE (USA)
HUF (D)

FOR:
PER:

JOHN DEERE

09

1691

Available by the end of July

JD1

HUF

100

Available by the end of July

HU162T

FOR:
PER:

01

COMMERCIAL GROUP
GRUPPO COMMERCIALE
PREISEGRUPPE
GROUPE COMMERCIAL
GRUPO COMMERCIAL
GRUPO COMMERCIAL

www.silca.biz



SILCA EMPTY SHELLS - NEW REFERENCES

 Silca Empty Shells: **2 new keys references** to widen the existing range.



 Silca Empty Shells: **2 nouvelles références** clés qui complètent la gamme existante.

 Silca Empty Shells: **2 nuove referenze** chiavi che implementano la gamma già esistente.

 Silca Empty Shells: **2 nuevas referencias** llaves que completan la gama existente.

 Silca Empty Shells: **2 Schlüssel Referenzen** die das bestehende Angebot implementieren.

 Silca Empty Shells: **2 novas referências** chaves que implementam a gama existente.

Brand	References/Image	Specifications	Vehicle Models*															
NISSAN®	<p>NSN14RS2</p> 	2 Buttons	<table border="1"> <thead> <tr> <th>MODELS</th> <th>YEAR FROM</th> <th>YEAR TO</th> <th>TRANSPONDER TYPE</th> <th>TRP ID</th> </tr> </thead> <tbody> <tr> <td>MICRA</td> <td>2010</td> <td>2014</td> <td>PH/CR2</td> <td>46</td> </tr> <tr> <td>NOTE</td> <td>2010</td> <td>2013</td> <td>PH/CR2</td> <td>46</td> </tr> </tbody> </table>	MODELS	YEAR FROM	YEAR TO	TRANSPONDER TYPE	TRP ID	MICRA	2010	2014	PH/CR2	46	NOTE	2010	2013	PH/CR2	46
MODELS	YEAR FROM	YEAR TO	TRANSPONDER TYPE	TRP ID														
MICRA	2010	2014	PH/CR2	46														
NOTE	2010	2013	PH/CR2	46														
NISSAN®	<p>NSN14RS8</p> 	3 Buttons	<table border="1"> <thead> <tr> <th>MODELS</th> <th>YEAR FROM</th> <th>YEAR TO</th> <th>TRANSPONDER TYPE</th> <th>TRP ID</th> </tr> </thead> <tbody> <tr> <td>JUKE</td> <td>2010</td> <td>2013</td> <td>PH/CR2</td> <td>46</td> </tr> <tr> <td>QASHQAI</td> <td>2010</td> <td>2013</td> <td>PH/CR2</td> <td>46</td> </tr> </tbody> </table>	MODELS	YEAR FROM	YEAR TO	TRANSPONDER TYPE	TRP ID	JUKE	2010	2013	PH/CR2	46	QASHQAI	2010	2013	PH/CR2	46
MODELS	YEAR FROM	YEAR TO	TRANSPONDER TYPE	TRP ID														
JUKE	2010	2013	PH/CR2	46														
QASHQAI	2010	2013	PH/CR2	46														

* The uses of the keys are purely indicative and may be subject to updates and revisions. / Gli utilizzi delle chiavi sono da considerarsi puramente indicativi e possono essere oggetto di aggiornamenti e revisioni. / Die Abbildung und technischen Daten der Schlüssel sind nicht bindend. Silca behält sich Änderungen am Produkt, die zur Verbesserung beitragen, vor. / Les usages des clés sont purement indicatifs; ils peuvent être mis à jour et revus. / Los usos de las llaves deben considerarse puramente indicativos y pueden ser objeto de actualizaciones y revisiones. / As utilizações das chaves devem ser consideradas puramente indicativas e podem ser objecto de actualizações e revisões.

© Registered Trademarks. / © Marchi Registrati. / © Eingetragene Marken. / © Marques Déposées. / © Marcas Registradas. / © Marcas Registradas.

Car Keys Guide / Guida Chiavi Auto / Marktführer für Autoschlüssel / Guide Clés pour Voitures
 Guía Llaves para Coches / Guia Chaves para Carros

New Updates

1	2	2a	3	3a	3b	E1+E2		6	42+71	72	43 44a	12	15
						GTI COMPATIBLE		IGNITION 					
CAR MAKE MODEL	FROM	TO	SILCA REF.	SILCA REF.	SILCA REF.	COPY	GEN.	TRANSP. TYPE	FAST COPY PLUS RW4 PLUS FAST COPY / RW4	FAST COPY PLUS RW4 PLUS	FAST COPY RW4	STP	
For more info on the uses of car keys, refer to the Silca Electronic Key Catalogue:													
AUDI®													
VARIOUS MODELS	2015		HU162T					MEG / CR	48				
JOHN DEERE®													
VARIOUS MODELS			JD1										
MITSUBISHI®													
ASX	2010							PH / CR2	46				
ASX	2010		MIT11RMH	MIT11RTE	MIT11RFH	Y	Y	PH / CR2	46	Y	P-BOX		
ASX	2014		SMART KEY					PH / CR3	49-1C				
MIRAGE	2014		SMART KEY					PH / CR3	49-1C				
OUTLANDER	2013		SMART KEY					PH / CR3	49-1C				
NISSAN®													
JUKE	2010	2013	NSN14RS8					PH / CR2	46				
MICRA	2010	2014	NSN14RS2					PH / CR2	46				
NOTE	2010	2013	NSN14RS2					PH / CR2	46				
QASHQAI	2010	2013	NSN14RS8					PH / CR2	46				
SEAT®													
VARIOUS MODELS	2015		HU162T					MEG / CR	48				
SKODA®													
VARIOUS MODELS	2014		HU162T					MEG / CR	48				
VOLKSWAGEN®													
VARIOUS MODELS	2014		HU162T					MEG / CR	48				

* The uses of the keys are purely indicative and may be subject to updates and revisions. / Gli utilizzi delle chiavi sono da considerarsi puramente indicativi e possono essere oggetto di aggiornamenti e revisioni. / Die Abbildung und technischen Daten der Schlüssel sind nicht bindend. Silca behält sich Änderungen am Produkt, die zur Verbesserung beitragen, vor. / Les usages des clés sont purement indicatifs; ils peuvent être mis à jour et revus. / Los usos de las llaves deben considerarse puramente indicativos y pueden ser objeto de actualizaciones y revisiones. / As utilizações das chaves devem ser consideradas puramente indicativas e podem ser objecto de actualizações e revisões.

© Registered Trademarks. / ® Marchi Registrati. / ® Eingetragene Marken. / ® Marques Déposées. / ® Marcas Registradas. / ® Marcas Registradas.



AD100 Pro

The new device for car key and remote programming

AD ADVANCED
DIAGNOSTICS

AD100 Pro

AD100 Pro is the leading car key and remote programmer for most vehicle makes and models worldwide.

Designed and engineered in the UK by Advanced Diagnostics, the pioneering and trustworthy manufacturer for aftermarket key programming tools, AD100 Pro is ideal for auto technicians and locksmiths providing high quality key and remote programming services.

AD100 Pro

AD100 Pro è un dispositivo all'avanguardia per la programmazione di chiavi e telecomandi per la maggior parte delle marche e dei modelli veicolo al mondo.

Progettato e sviluppato nel Regno Unito da Advanced Diagnostics, azienda di riferimento a livello internazionale nel settore della programmazione automotiva, AD100 Pro è ideale per gli specialisti dell'auto e della duplicazione chiavi che offrono un servizio telecomandi e chiavi veicolo.

AD100 Pro

AD100 Pro ist das führende Gerät, zum Programmieren von Autoschlüsseln und Fernbedienungen für die meisten Automarken und Fahrzeugmodelle weltweit.

Entwickelt und hergestellt in Großbritannien von Advanced Diagnostics, dem bahnbrechenden und vertrauenswürdigen Hersteller für zeitgemäße Schlüssel-Programmiergeräte. AD100 Pro ist ideal für Kfz-Fachleute und Schlüsseldienste, die hochwertigen Schlüssel- und Funkfernbedienungsservice anbieten möchten.

AD100 Pro

L'AD100 Pro est le produit leader sur le marché des programmeurs de clés de véhicules et de télécommandes pour la majorité des marques et des modèles.

Conçu et fabriqué au Royaume-Uni par Advanced Diagnostics, spécialiste reconnu pour ce type de produits chez les professionnels des pièces de rechange automobiles, l'AD100 Pro est l'outil idéal pour ceux qui souhaitent offrir un service de qualité de programmation de clés et de télécommandes sur la majorité des marques et des modèles de véhicules.

AD100 Pro

La programadora de llaves de coches AD100 Pro es líder del mercado en programación de llaves y mandos en la mayoría de marcas y modelos en todo el mundo.

Diseñado y fabricado en el Reino Unido por Advanced Diagnostics, productor pionero y confiable en el mercado de repuestos del automóvil, AD100 Pro es el dispositivo ideal para especialistas del automóvil y cerrajeros que quieren ofrecer calidad a sus clientes en la programación llaves y mandos en los vehículos.

AD100 Pro

AD100 Pro é um dispositivo de vanguarda para a programação de chaves e telecomandos para a maioria das casas automobilísticas do mundo.

Projectado e desenvolvido no Reino Unido pela Advanced Diagnostics, empresa de referência a nível internacional para a programação automotiva, AD100 Pro é ideal para os especialistas do automóvel e da duplicação de chaves que propõem um serviço de programação de telecomandos e chaves para veículo.

> More info on all Silca websites, www.silca-automotive.com and www.advanced-diagnostics.com

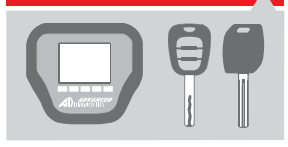

MVP Pro

The new device for car key and remote programming

AD ADVANCED DIAGNOSTICS

MVP Pro

If you are new to the industry or simply looking for a cost effective way to offer a car key and remote programming service to your customers, then MVP Pro is the right solution for you.

Designed and engineered in the UK by Advanced Diagnostics, the pioneering and trustworthy manufacturer for aftermarket key programming tools, MVP Pro is ideal for auto technicians and locksmiths providing high quality key and remote programming services on a 'pay as you go' basis.

MVP Pro

Si vous êtes nouveau dans le secteur de la programmation de clés ou à la recherche d'un nouveau service rentable à proposer à vos clients, MVP Pro est la solution qu'il vous faut.

Conçu et fabriqué par Advanced Diagnostics, spécialiste reconnu chez les professionnels des pièces de rechange automobiles, MVP Pro est l'outil idéal pour la programmation de clés et de télécommandes pour la majorité des marques de véhicules dans le monde, avec un système de paiement à l'utilisation.

MVP Pro

Se sei un neofita del settore automotive o stai cercando una soluzione economicamente vantaggiosa per offrire un servizio di programmazione chiavi auto ai tuoi clienti, MVP Pro è la soluzione giusta per te.

Progettato e sviluppato da Advanced Diagnostics, azienda di riferimento internazionale nella programmazione automotive, MVP Pro è ideale per gli specialisti dell'auto e della duplicazione chiavi e telecomandi veicolo che vogliono dotarsi di un dispositivo con formula 'pay per use'.

MVP Pro

Si usted es nuevo en el negocio del inmovilizador o sencillamente está buscando una manera rentable de ofrecer un nuevo servicio a sus clientes, MVP Pro es la solución.

Diseñado y fabricado por Advanced Diagnostics, productor pionero y confiable en el mercado de repuestos del automóvil, MVP Pro es la herramienta ideal para la programación de llaves y mandos para la mayoría de las marcas de vehículos de todo el mundo con una plataforma prepago.

MVP Pro

Wenn Sie neu in der Branche sind, oder einfach nur auf der Suche nach einem kostengünstigen Weg, um ihren Kunden die Schlüsselprogrammierung anzubieten, dann ist MVP Pro die Lösung.

Entwickelt und hergestellt von Advanced Diagnostics, dem bahnbrechenden und vertrauenswürdigen Hersteller von Schlüsselprogrammiergeräten, ist MVP Pro ideal für Kfz-Fachleute und Schlüsseldienste, die die Programmierung von Schlüsseln und Fernbedienungen auf einer "Pay as you go"-Basis anbieten möchten.

MVP Pro

Se for um neófito do sector automotive ou se estiver a procurar uma solução economicamente vantajosa para oferecer um serviço de programação de chaves para os seus clientes, MVP Pro é a solução perfeita para si.

Projectado e desenvolvido pela Advanced Diagnostics, empresa de referência na programação automotive, MVP Pro é a solução ideal para os especialistas do automóvel e da duplicação de chaves e telecomandos para veículo que desejem equipar-se com um dispositivo com fórmula 'pay per use'.

> More info on all Silca websites, www.silca-automotive.com and www.advanced-diagnostics.com



Smart Dongle - AD600 Code Wizard Pro

For car key and remote programming

SMART DONGLE

Smart Dongle provides 'one easy to use solution' by replacing the current range of dongles with one automatic configurable dongle.

AD600 Code Wizard Pro

AD600 Code Wizard Pro is a software program specifically developed for professional automotive locksmiths for calculating mechanical key codes from the VIN number and for generating immobiliser and mechanical key codes including access to security functions.

SMART DONGLE

Smart Dongle est une solution facile d'utilisation qui remplace la gamme actuelle de dongles par un dongle qui se configure automatiquement.

AD600 Code Wizard Pro

AD600 Code Wizard Pro est un logiciel spécifiquement développé pour des reproducteurs de clés de véhicules professionnels pour calculer des codes mécaniques des clés à partir du numéro VIN d'un véhicule et pour générer un transpondeur et un code de taille habituellement indisponibles au marché du remplacement.

SMART DONGLE

Smart Dongle offre una soluzione unica e di facile utilizzo per sostituire l'attuale gamma di dongle con un unico dongle configurabile automaticamente.

AD600 Code Wizard Pro

AD600 Code Wizard Pro è un programma software sviluppato specificamente per i duplicatori di chiavi veicolo per calcolare un'estesa gamma di codici di sicurezza a partire dal numero di telaio dell'auto, come codici pin, meccanici ed immobilizer.

SMART DONGLE

Smart Dongle proporciona una facilidad de uso para su dispositivo al reemplazar los numerosos dongles de programación en un único dongle autoconfigurable.

AD600 Code Wizard Pro

AD600 es un programa de software desarrollado específicamente para los cerrajeros de automoción profesionales para calcular códigos de llaves mecánicas de número VIN (número de bastidor o de chasis) y capacidad de generar bloqueo y códigos de llaves mecánicas, incluyendo el acceso a las funciones de seguridad.

SMART DONGLE

Der Smart-Dongle bietet eine einzigartige Lösung durch Austausch der derzeitigen Produktpalette an Donglen mit einem automatisch konfigurierbaren Dongle.

AD600 Code Wizard Pro

AD600 Code Wizard Pro ist ein Software-Programm, das speziell für professionelle Schlüsseldienste entwickelt wurde, für die Berechnung des mechanischen Schlüsselcodes anhand der Fahrgestellnummer und für die Erzeugung des Codes einer Wegfahrsperrung und eines mechanischen

SMART DONGLE

Smart Dongle proporciona uma solução única e de utilização fácil para substituir a gama actual de dongles por um dongle único que se configura automaticamente.

AD600 Code Wizard Pro

AD600 Code Wizard Pro é um programa software desenvolvido expressamente para os especialistas que propõem um serviço de programação de chaves para veículo para calcular uma ampla gama de códigos de segurança a partir do número de chassi do carro, como os códigos pin, mecânicos e de imobilização.

> More info on all Silca websites, www.silca-automotive.com and www.advanced-diagnostics.com

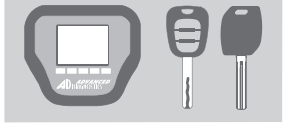

Free Software Update ADS222 - Ford® Coded 2014 Reduces the up to 5 hour procedure to within 8 minutes when using the Smart Dongle



 **Advanced Diagnostics have released a free software update available for ADS222 Ford® Coded 2014.**

The update reduces the 'up to 5 hour procedure' to within 8 minutes for programming keys - when using the Smart Dongle. Without the Smart Dongle the wait time remains up to 5 hours if you do not have a Ford dealer login. For the vehicle application list, please see the table that follows or check the IQ tool on the Advanced Diagnostics website (North American vehicles are excluded).

 **Advanced Diagnostics ti offre l'aggiornamento gratuito del software per i modelli Ford® Coded 2014 (ADS222).**

L'aggiornamento software, con l'aiuto di Smart Dongle, ti offre la possibilità di ridurre il tempo di programmazione della chiave da 5 ore a 8 minuti circa. Se non disponi dello Smart Dongle e non hai accesso al codice di sicurezza originale rilasciato da Ford ai concessionari autorizzati, la procedura di programmazione della chiave richiede sempre un tempo che può arrivare fino a 5 ore.

Vedi la lista dei veicoli riconosciuti dal nuovo software nella tabella a seguito o su IQ nel sito di Advanced Diagnostics (esclusi i veicoli del mercato nordamericano).

 **Advanced Diagnostics bietet die kostenfreie Aktualisierung der Software für die Modelle Ford® Coded 2014 (ADS222).**

Die Aktualisierung der Software mit Smart Dongle bietet die Möglichkeit die Zeit für die Schlüsselprogrammierung von 5 Stunden auf ungefähr 8 Minuten zu kürzen. Wenn Sie keinen Smart Dongle haben und nicht über den originalen Sicherheitszugangscode verfügen, den Ford den Vertragshändler liefert, dann kann der Vorgang zur Schlüsselprogrammierung bis zu 5 Stunden dauern.

Siehe die Liste der von der neuen Software erkannten Fahrzeuge in der beigelegten Tabelle oder im IQ auf der Webseite Advanced Diagnostics (Fahrzeuge des USA-Marktes ausgeschlossen).

 **Advanced Diagnostics vous offre la mise à jour gratuite du logiciel pour les modèles Ford® Coded 2014 (ADS222).**

La mise à jour du logiciel, avec l'aide de Smart Dongle, vous permettra d'abattre le temps de programmation de la clé de 5 heures à 8 minutes environ. Si vous n'avez pas de Smart Dongle et que vous n'avez pas accès au code de sécurité original délivré par Ford aux concessionnaires autorisés, il faudra compter un temps de 5 heures environ pour la procédure de programmation de la clé.

Voir la liste des véhicules reconnus par le nouveau logiciel dans le tableau ci-dessous ou sur l'IQ dans le site Advanced Diagnostics (sauf pour les véhicules du marché nord-américain).

 **Advanced Diagnostics te ofrece la actualización gratis del software para los modelos Ford® Coded 2014 (ADS222).**

La actualización software, con Smart Dongle, te permite reducir el tiempo de programación de la llave de 5 horas a 8 minutos aproximadamente. Si no tienes el Smart Dongle y no puedes acceder al código de seguridad original expedido por Ford a los concesionarios autorizados entonces el procedimiento de programación de la llave requiere como siempre un tiempo máximo de 5 horas.

Consulta la lista de los vehículos reconocidos por el nuevo software en la tabla siguiente o en IQ en la web de Advanced Diagnostics (salvo para los vehículos del mercado norteamericano).

 **A Advanced Diagnostics oferece a atualização gratuita do software para os modelos Ford® Coded 2014 (ADS222).**

A atualização do software, com o auxílio de Smart Dongle, dá a possibilidade de reduzir o tempo de programação da chave de 5 horas para aproximadamente 8 minutos. Se não dispuser do Smart Dongle e não tiver acesso ao código de segurança original passado pela Ford aos concessionários autorizados, o procedimento de programação da chave necessita sempre de um tempo que pode chegar até 5 horas.

Veja a lista dos veículos reconhecidos pelo novo software na tabela que segue ou em IQ no site da Advanced Diagnostics (excluídos os veículos do mercado norte-americano).



MVP Pro Customers

MVP Pro customers will receive this software update free of charge (requires Smart Dongle for functionality). / I clienti che possiedono MVP Pro riceveranno l'aggiornamento software gratuitamente (è richiesto l'utilizzo di Smart Dongle per questa funzionalità). / Die Kunden, die schon über MVP Pro verfügen, bekommen die Aktualisierung der Software kostenfrei (für diese Funktion muss Smart Dongle verwendet werden). / Les clients possédant MVP Pro recevront la mise à jour du logiciel gratuitement (pour cette fonction il faudra utiliser Smart Dongle). / Los clientes en posesión de MVP Pro recibirán la actualización gratis del software (esta función requiere el uso del Smart Dongle). / Os clientes que possuem MVP Pro receberão gratuitamente a atualização do software (é exigida a utilização de Smart Dongle para essa função).



AD100 Pro Customers

AD100Pro customers that have purchased ADS222 will receive this update free of charge (requires Smart Dongle for functionality). / I clienti che possiedono AD100 Pro e hanno acquistato il software ADS222 riceveranno l'aggiornamento software gratuitamente (è richiesto l'utilizzo di Smart Dongle per questa funzionalità). / Die Kunden, die schon über AD100 Pro verfügen und die Software ADS222 gekauft haben, bekommen die Aktualisierung der Software kostenfrei (für diese Funktion muss Smart Dongle verwendet werden). / Les clients possédant AD100 Pro ayant acheté le logiciel ADS222 recevront la mise à jour gratuitement (pour cette fonction il faudra utiliser Smart Dongle). / Los clientes en posesión de AD100 Pro y que han comprado el software ADS222 recibirán la actualización gratis del software (esta función requiere el uso del Smart Dongle). / Os clientes que possuem AD100 Pro e adquiriram o software ADS222 receberão gratuitamente a atualização (é exigida a utilização de Smart Dongle para essa função).

> More info on www.advanced-diagnostics.com

Free Software Update ADS222 - Ford® Coded 2014 Reduces the up to 5 hour procedure to within 8 minutes when using the Smart Dongle



- Please connect your Pro tester and Smart Dongle to the AD Loader and update to both.

- Tester Version: 12.03 BETA
 - Smart Dongle Version: 1.1.2
- The use of the following is required:
- Cable: ADC250 or ADC151
 - Dongle: Smart Dongle
 - Software category: A
 - Other software required: ADS162

AD Software described in this release may not be applicable to all markets and countries: please consult with your local distributor or sales rep for further information.

- Connecter le dispositif de programmation et Smart Dongle au programme AD Loader pour les mettre à jour tous les deux.

- Version dispositif: 12.03 BETA
 - Version Smart Dongle: 1.1.2
- Éléments indispensables:
- Câble: ADC250 ou ADC151
 - Dongle: Smart Dongle
 - Catégorie du logiciel: A
 - Autres logiciels requis: ADS162

La mise à jour du logiciel ne peut être disponible sur tous les marchés et tous les pays: veuillez contacter votre distributeur local ou votre agent référentiel pour de plus amples informations.

- Collegare il dispositivo di programmazione e lo Smart Dongle al programma AD Loader per aggiornare entrambi.

- Versione dispositivo: 12.03 BETA
 - Versione Smart Dongle: 1.1.2
- È richiesto l'utilizzo dei seguenti:
- Cavo: ADC250 o ADC151
 - Dongle: Smart Dongle
 - Categoria software: A
 - Altri software richiesti: ADS162

L'aggiornamento software può non essere disponibile in tutti i mercati e paesi: contatta il tuo distributore locale o il tuo agente di riferimento per ulteriori informazioni.

- Conecta el dispositivo de programación y el Smart Dongle al programa AD Loader para actualizar ambos.

- Versión del dispositivo: 12.03 BETA
 - Versión de Smart Dongle: 1.1.2
- Se requiere el uso de los siguientes:
- Cable: ADC250 o ADC151
 - Dongle: Smart Dongle
 - Categoría del software: A
 - Otros softwares requeridos: ADS162

La actualización del software no está disponible en todos los mercados y países: contacta a tu distribuidor local o a tu agente de referencia para obtener información adicional.

- Das Programmiergerät und den Smart Dongle an das Programm AD Loader verbinden, um beide zu aktualisieren.

- Version des Geräts: 12.03 BETA
 - Version Smart Dongle: 1.1.2
- Es sind folgende Komponente erforderlich:
- Kabel: ADC250 oder ADC151
 - Dongle: Smart Dongle
 - Kategorie der Software: A
 - Weitere erforderliche Software: ADS162

Möglicherweise ist die Aktualisierung der Software nicht für alle Märkte und Länder erhältlich: wenden Sie sich an Ihren lokalen Distributor oder an Ihren Händler für weitere Infos.

- Ligar o dispositivo de programação e o Smart Dongle ao programa AD Loader para atualizar ambos.

- Versão do dispositivo: 12.03 BETA
 - Versão Smart Dongle: 1.1.2
- É exigida a utilização dos seguintes:
- Cabo: ADC250 ou ADC151
 - Dongle: Smart Dongle
 - Categoria software: A
 - Outros softwares solicitados: ADS162

A atualização do software pode não estar disponível em todos os mercados e países: contacte o seu distribuidor local ou o seu agente de referência para mais informações.

			1 2 3 4		PRO		
B-MAX (BLADE) 2012 - 2014	✓	✓	✓	✓	ADC250 OR ADC251	SMART DONGLE	✗
C-MAX (BLADE) & (PROX) 2010 - 2014	✓	✓	✓	✓	ADC250 OR ADC251	SMART DONGLE	✗
COURIER (BLADE) 2013 - 2014	✓	✓	✓	✓	ADC250 OR ADC251	SMART DONGLE	✗
FIESTA (BLADE) 2013 - 2014	✓	✓	✓	✓	ADC250 OR ADC251	SMART DONGLE	✗
FOCUS (BLADE) & (PROX) 2011 - 2014	✓	✓	✓	✓	ADC250 OR ADC251	SMART DONGLE	✗
GALAXY (BLADE) & (PROX) 2010 - 2014	✓	✓	✓	✓	ADC250 OR ADC251	SMART DONGLE	✗
KUGA (PROX) 2013 - 2014	✓	✓	✓	✓	ADC250 OR ADC251	SMART DONGLE	✗
MONDEO (BLADE) & (PROX) 2010 - 2014	✓	✓	✓	✓	ADC250 OR ADC251	SMART DONGLE	✗
RANGER (BLADE) 2012 - 2014	✓	✓	✓	✓	ADC250 OR ADC251	SMART DONGLE	✗
S-MAX (BLADE) & (PROX) 2010 - 2014	✓	✓	✓	✓	ADC250 OR ADC251	SMART DONGLE	✗

> More info on www.advanced-diagnostics.com

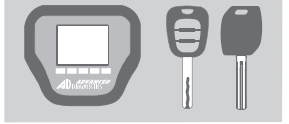

New Software Release ADS227 - Toyota® 2015 (USA) For vehicles in North America

AD ADVANCED
DIAGNOSTICS

 Advanced Diagnostics are pleased to announce the release of ADS227 key programming software for Toyota® and Lexus® vehicles found in North America. Please see the vehicle application list below and on the IQ tool of the Advanced Diagnostics website.

Toyota® 2015 software is specifically for AD100 Pro and MVP Pro programmers and will program bladed and proximity keys.

No pin code or working key is required.

AD Software described in this release may not be applicable to all markets and countries: please consult with your local distributor or sales rep for further information.

 Advanced Diagnostics a délivré le nouveau logiciel ADS227 pour programmer les clés des véhicules Toyota® et Lexus® nord-américains. Voir la liste des véhicules identifiés par le nouveau logiciel dans le tableau ci-dessous ou sur IQ sur le site Advanced Diagnostics.

Le logiciel Toyota® 2015 est spécifique pour les dispositifs AD100 Pro et MVP Pro et permet de programmer des clés à canon métallique ainsi que des clés de proximité.

Nul besoin de code pin ni de clé en ordre de marche.

La mise à jour du logiciel ne peut être disponible sur tous les marchés et tous les pays: veuillez contacter votre distributeur local ou votre agent référentiel pour de plus amples informations.

 Advanced Diagnostics ha rilasciato il nuovo software ADS227 per la programmazione di chiavi dei veicoli Toyota® e Lexus® nordamericani. Vedi la lista dei veicoli riconosciuti dal nuovo software nella tabella a seguito o su IQ nel sito di Advanced Diagnostics.

Il software Toyota® 2015 è specifico per i dispositivi AD100 Pro e MVP Pro e consente di programmare chiavi con canna metallica e chiavi di prossimità.

Non è richiesto alcun codice pin o chiave funzionante.

L'aggiornamento software può non essere disponibile in tutti i mercati e paesi: contatta il tuo distributore locale o il tuo agente di riferimento per ulteriori informazioni.

 AD ha realizado el nuevo software ADS227 para la programación de llaves de los vehículos norteamericanos Toyota® y Lexus®. Consulta la lista de los vehículos reconocidos por el nuevo software en la tabla siguiente o en IQ en la web de Advanced Diagnostics.

El software Toyota® 2015 es específico para los dispositivos AD100 Pro y MVP Pro; permite programar llaves con cuerpos metálicos y llaves de proximidad.

No se requieren códigos pin o una llave funcionante.

La actualización del software no está disponible en todos los mercados y países: contacta a tu distribuidor local o a tu agente de referencia para obtener información adicional.

 AD hat die neue Software ADS227 für die Programmierung von Schlüsseln der nordamerikanischen Fahrzeuge der Toyota® und Lexus® herausgegeben. Siehe die Liste der von der neuen Software erkannten Fahrzeuge in der beigelegten Tabelle oder im IQ auf der Webseite Advanced Diagnostics.

Die Software Toyota® 2015 ist spezifisch für die Geräte AD100 Pro und MVP Pro und ermöglicht das Programmieren von Schlüsseln mit auswechselbaren Metallschaft und Näherungsschlüsseln.

Kein Pin-Code oder funktionierender Schlüssel notwendig.

Möglicherweise ist die Aktualisierung der Software nicht für alle Märkte und Länder erhältlich: wenden Sie sich an Ihren lokalen Distributor oder an Ihren Händler für weitere Infos.

 A Advanced Diagnostics produziu o novo software ADS227 para a programação das chaves dos veículos Toyota® e Lexus® norte-americanos. Veja a lista dos veículos reconhecidos pelo novo software na tabela que segue ou em IQ no site da Advanced Diagnostics.

O software Toyota® 2015 é específico para os dispositivos AD100 Pro e MVP Pro e permite programar chaves com cana metálica e chaves de proximidade.

Não é necessário nenhum código pin ou chave que funcione.

A atualização do software pode não estar disponível em todos os mercados e países: contacte o seu distribuidor local ou o seu agente de referência para mais informações.



MVP Pro Customers

MVP Pro customers will receive this software FREE of charge. Please update your tester to Version 12.04 BETA. / I clienti che possiedono MVP Pro riceveranno l'aggiornamento software gratuitamente. È necessario aggiornare il dispositivo alla versione software 12.04 BETA. / Die Kunden die schon über MVP Pro verfügen bekommen die Aktualisierung der Software kostenfrei. Das Gerät muss auf die Version Software 12.04 BETA aktualisiert werden. / Les clients possédant MVP Pro recevront la mise à jour du logiciel gratuitement. Il faut mettre le dispositif à jour avec la version logiciel 12.04 BETA. / Los clientes en posesión de MVP Pro recibirán la actualización gratis del software. Se ha de actualizar el dispositivo para la versión 12.04 BETA del software. / Os clientes que possuem MVP Pro receberão gratuitamente a atualização do software. É necessário atualizar o dispositivo à versão de software 12.04 BETA.

> More info on www.advanced-diagnostics.com

New Software Release ADS227 - Toyota® 2015 (USA) For vehicles in North America



 - Please update your programmer to Version 12.04 BETA.

The use of the following is required:

- Cable: ADC250 or ADC151
- Dongle: A or Smart Dongle
- Software category: A
- Other software required: ADS199
- Smartcard: yes or Smart Dongle

Subaru BRZ does not support "immobilizer reset". Duplicates only if NO programmed key is available.

 - È necessario aggiornare il dispositivo alla versione software 12.04 BETA.

È richiesto l'utilizzo dei seguenti:

- Cavo: ADC250 o ADC151
- Dongle: A o Smart Dongle
- Categoria software: A
- Altri software richiesti: ADS199
- Smartcard: sì o Smart Dongle

Subaru BRZ non supporta la funzione di reset dell'immobilizer. È possibile duplicare la chiave solo se NON è disponibile una chiave già programmata.

 - Das Gerät muss auf die Version Software 12.04 BETA aktualisiert werden.

Es sind folgende Komponente erforderlich:

- Kabel: ADC250 oder ADC151
- Dongle: A oder Smart Dongle
- Kategorie der Software: A
- Weitere erforderliche Software: ADS199
- Smartcard: ja oder Smart Dongle

Subaru BRZ unterstützt den Reset des Immobilizer nicht. Der Schlüssel kann nur dann kopiert werden, wenn KEIN programmierter Schlüssel verfügbar ist.

 - Il faut mettre le dispositif à jour avec la version logiciel 12.04 BETA.

Éléments indispensables:

- Câble: ADC250 ou ADC151
- Dongle: Smart Dongle
- Catégorie du logiciel: A
- Autres logiciels requis: ADS162
- Smartcard: oui ou Smart Dongle

Subaru BRZ ne seconde pas la fonction reset de l'anti-démarrage. Il n'est possible de reproduire la clé QUE si on dispose d'une clé déjà programmée.

 - Se ha de actualizar el dispositivo para la versión 12.04 BETA del software.

Se requiere el uso de los siguientes:

- Cable: ADC250 o ADC151
- Dongle: A o Smart Dongle
- Categoría del software: A
- Otros softwares requeridos: ADS199
- Smartcard: sí o Smart Dongle







Subaru BRZ no soporta la función de reset del immobilizer. Se puede duplicar la llave únicamente si NO existe una llave programada anteriormente.

 - É necessário atualizar o dispositivo à versão de software 12.04 BETA.

É exigida a utilização dos seguintes:

- Cabo: ADC250 o ADC151
- Dongle: A ou Smart Dongle
- Categoria software: A
- Outros softwares solicitados: ADS199
- Smartcard: sim ou Smart Dongle

Subaru BRZ não suporta a função de reset do sistema de imobilização. É possível duplicar a chave só se NÃO estiver disponível uma chave já programada.

			1 2 3 4		PRO 		 Requires at least 1 working key
LEXUS IS250 (PROX) 2014 - 2015	✓	✓	✗	✗	ADC250 OR ADC251	A or SMART DONGLE	✗
LEXUS IS350 (PROX) 2014 - 2015	✓	✓	✗	✗	ADC250 OR ADC251	A or SMART DONGLE	✗
SCION FR-S (BLADE) & (PROX) 2013 - 2015	✓	✓	✗	✗	ADC250 OR ADC251	A or SMART DONGLE	✗
SUBARU BRZ (BLADE) & (PROX) 2013 - 2015	✓	✓	✗	✗	ADC250 OR ADC251	A or SMART DONGLE	✓
TOYOTA HIGHLANDER (PROX) 2015	✓	✓	✗	✗	ADC250 OR ADC251	A or SMART DONGLE	✗

> More info on www.advanced-diagnostics.com

New Software Release ADS229 - PSA PINCODE READ For Peugeot® and Citroën® Vehicle (excluding North America)



Advanced Diagnostics are pleased to announce the release of ADS229 PSA PINCODE Read software for various Peugeot® and Citroën® vehicles found worldwide (excluding North America).

Please refer to the application list below for the models covered by this software or refer to the IQ database.

This software does NOT cover Johnson Controls equipped vehicles at present.

The PIN read process takes less than 60 seconds to complete - and bladed and Proximity keys are covered.

A working key is NOT required to read the PINCODE.

Please note: during the pin reading process, it is possible that the wipers on the vehicle may be activated.

MVP Pro Customers will receive this software FREE of charge.

AD Software described in this release may not be applicable to all markets and countries: please consult with your local distributor or sales rep for further information.

Advanced Diagnostics ha rilasciato il nuovo software ADS229 per la lettura dei codici pin PSA per numerosi modelli Peugeot® e Citroën® diffusi a livello internazionale (sono esclusi i veicoli del mercato nordamericano).

Vedi la lista dei veicoli riconosciuti dal nuovo software nella tabella a seguito o su IQ nel sito di Advanced Diagnostics.

Al momento il software NON copre i veicoli dotati di sistemi di controllo Johnson Controls, ma permette di duplicare sia chiavi dotate di canna metallica che chiavi di prossimità.

Il processo di lettura del codice pin richiede meno di 60 secondi. NON è richiesta una chiave funzionante per leggere il codice pin.

Nota importante: In alcuni casi, è necessario attivare i tergicristalli del veicolo durante la lettura del codice pin.

I clienti che possiedono MVP Pro riceveranno l'aggiornamento software gratuitamente.

L'aggiornamento software può non essere disponibile in tutti i mercati e paesi: contatta il tuo distributore locale o il tuo agente di riferimento per ulteriori informazioni.

Advanced Diagnostics freut sich die Version ADS229: PSA PINCODE Read Software für verschiedene weltweite Peugeot® und Citroen® Fahrzeuge (ausgenommen Nordamerika) ankündigen zu dürfen.

Bitte schauen Sie in die beiliegende Referenztabelle welche Modelle von dieser Software abgedeckt sind, bzw. schauen Sie bitte in die IQ Datenbank. Die Software deckt zum jetzigen Zeitpunkt KEINE Fahrzeuge ab die mit Komponenten von Johnson Controls ausgestattet sind.

Der Prozess um den Pin auszulesen dauert weniger als 60 Sekunden – und deckt mechanische und elektronische (Keyless) Schlüssel ab.

Es ist kein funktionierender Schlüssel notwendig, um den Pincode auszulesen.

Bitte beachten: Während des Pin-Lese-Prozesses kann es sein, dass die Scheibenwischer des Fahrzeugs aktiviert werden.

MVPPro Kunden werden die Software KOSTELOS zur Verfügung gestellt bekommen.

Möglicherweise ist die Aktualisierung der Software nicht für alle Märkte und Länder erhältlich: wenden Sie sich an Ihren lokalen Distributor oder an Ihren Händler für weitere Infos.

CITROËN C3 (BLADE) 2008 ONWARDS	✓ ADS142	✓ ADS142	✓	✓	ADC250 OR ADC251	H or SMART DONGLE	✗
CITROËN C3 PICASSO (BLADE) ALL YEARS	✓ ADS142	✓ ADS142	✓	✓	ADC250 OR ADC251	H or SMART DONGLE	✗
CITROËN C4 (BLADE & PROX) 2011 ONWARDS	✓ ADS142	✓ ADS142	✓	✓	ADC250 OR ADC251	H or SMART DONGLE	✗
CITROËN DS3 (BLADE) ALL YEARS	✓ ADS142	✓ ADS142	✓	✓	ADC250 OR ADC251	H or SMART DONGLE	✗
CITROËN DS4 (BLADE & PROX) ALL YEARS	✓ ADS142	✓ ADS142	✓	✓	ADC250 OR ADC251	H or SMART DONGLE	✗
CITROËN DS5 (BLADE & PROX) ALL YEARS	✓ ADS142	✓ ADS142	✓	✓	ADC250 OR ADC251	H or SMART DONGLE	✗
PEUGEOT 207 (BLADE) ALL YEARS	✓ ADS142	✓ ADS142	✓	✓	ADC250 OR ADC251	H or SMART DONGLE	✗
PEUGEOT 308 (BLADE) ALL YEARS	✓ ADS142	✓ ADS142	✓	✓	ADC250 OR ADC251	H or SMART DONGLE	✗



New Software Release ADS229 - PSA PINCODE READ For Peugeot® and Citroën® Vehicle (excluding North America)



FR Advanced Diagnostics a publié le nouveau software ADS229 pour la lecture des codes pin PSA pour de nombreux modèles Peugeot® et Citroën® distribués sur le Marché International (sont exclus les véhicules du Marché Nord-Américain).

Vous pouvez consulter la liste des véhicules reconnus par le nouveau software dans le tableau ci-dessous ou avec IQ sur le Site Web de Advanced Diagnostics.

Actuellement le software n'inclue pas les véhicules dotés de systèmes de contrôle Johnson Controls, mais permet de copier les clés composées de canne métallique que clés de proximité.

Le procès de lecture du code Pin demande moins de 60 secondes.

Il n'est pas nécessaire avoir une clé fonctionnelle pour lire le code pin.

Important: dans certains cas, il est nécessaire allumer les essuies-glace du véhicule durant la lecture du code pin.

Les clients qui possèdent MVP Pro, recevront gratuitement une mise à jour du software.

La mise à jour du logiciel ne peut être disponible sur tous les marchés et tous les pays: veuillez contacter votre distributeur local ou votre agent référentiel pour de plus amples informations.

ES AD se complace en anunciarle el lanzamiento del nuevo software ADS229 LECTOR PINCODE PSA. Cubriendo parte de la gama Peugeot® y Citroën® fabricada en todo el mundo (Excluyendo Norte América).

Puede dirigirse a la lista de aplicaciones o a la base de datos IQ para comprobar la cobertura proporcionada por el software. El software no cubre la lectura de códigos PIN en vehículos equipados con unidades Johnson Controls hasta el presente.

El proceso de lectura del PIN tarda menos de 60 segundos hasta completar el procedimiento de lectura y es válido tanto para llaves de espadín como sistemas proximidad.

No es necesario tener llaves arrancando para la lectura del PIN CODE.

Tenga en cuenta: Durante el proceso de lectura de PIN CODE es posible que los limpiaparabrisas se activen.

Los propietarios de MVP Pro podrán descargarse el nuevo software de forma gratuita.

La actualización del software no está disponible en todos los mercados y países: contacta a tu distribuidor local o a tu agente de referencia para obtener información adicional.



OFFER DETAILS

CABLE	ADC250 or ADC251
DONGLE	H or SMART DONGLE
SOFTWARE CATEGORY	B
OTHER SOFTWARE REQUIRED	ADS142
SMART CARD	YES or SMART DONGLE







Silca Key Programs

Update 2/2015 - SKP Vers. 20.6.4.xx

UPDATE 2/2015

New Silca Key Programs 2/2015 Update for all WEB and DVD subscribers available on the “News” section of Silca Key Programs.

Discover all the updates for Silca Code Program, Silca Idea Program, Silca Viper Program, Silca Triax Program, Silca Quattrocode Program and Silca Transponder Program.

MISE A JOUR 2/2015

Nouvelle mise à jour Silca Key Programs 2/2015 pour tous les abonnés WEB et DVD disponible dans la section “Nouveautés” de Silca Key Programs.

Découvrez toutes les mises à jour pour Silca Code Program, Silca Idea Program, Silca Viper Program, Silca Triax Program, Silca Quattrocode Program et Silca Transponder Program.

AGGIORNAMENTO 2/2015

Nuovo Aggiornamento Silca Key Programs 2/2015 per tutti gli abbonati WEB e DVD consultabile nella sezione “Novità” di Silca Key Programs.

Scopri tutti gli aggiornamenti per Silca Code Program, Silca Idea Program, Silca Viper Program, Silca Triax Program, Silca Quattrocode Program e Silca Transponder Program.

ACTUALIZACIÓN 2/2015

Nueva actualización Silca Key Programs 2/2015 para todos los abonados WEB y DVD disponible en la sección “Novedades” de Silca Key Programs.

Descubra todas las actualizaciones para Silca Code Program, Silca Idea Program, Silca Viper Program, Silca Triax Program, Silca Quattrocode Program y Silca Transponder Program.

AKTUALISIERUNG 2/2015

Neue Aktualisierung Silca Key Programs 2/2015 für alle WEB und DVD Abonnenten ist in der Sektion “Neuheiten” des Silca Key Programs verfügbar.

Entdecken Sie die Aktualisierungen für Silca Code Program, Silca Idea Program, Silca Viper Program, Silca Triax Program, Silca Quattrocode Program und Silca Transponder Program.

ATUALIZAÇÃO 2/2015

Nova atualização Silca Key Programs 2/2015 para todos o assinantes WEB e DVD disponível na seção “Novidades” de Silca Key Programs.

Descubra todas as atualizações para Silca Code Program, Silca Idea Program, Silca Viper Program, Silca Triax Program, Silca Quattrocode Program e Silca Transponder Program.

[> More info on all Silca websites](#)

SILCA KEY PROGRAMS

New Functions

SKP Vers. 20.6.4.xx

New items include: / Tra le novità: / Unter den Neuheiten: / Parmi les nouveautés: / Entre las novedades: / Entre as novidades:

- Decoding for SN 823, 850 and 860 (Renault® (Clio III), Peugeot®, Citroën® and Toyota® car keys).

- SMART decoding for KESO® 1000-2000-4000-CASA systems. The new decoding recognises the real key cuts and ignores "PRE-CUTS" (cuts by manufacturer).

- New "banner" function for viewing important messages or receiving communications directly from the Silca website (connect PC to the internet).

- New function for searches by KEY BLANK: when at least 3 characters plus the "*" character are entered the search shows all the series that use a key blank starting with those characters. E.g. when "GT1*" is entered the function will find all the series that use a key blank starting with GT1.... This function is available also in searches by key blank in the Silca Transponder Program.

- If you run SKP MARKET/STOCK the key blanks included in these groups will be colour highlighted also in the search window.

- Comparatives refreshed.

- F9 function included for reading bar codes in the Kaba® ExperT pluS systems.

- Decodierung für SN 823, 850 und 860 (Autoschlüssel Renault® (Clio III), Peugeot®, Citroën® und Toyota®).

- Decodierung SMART für die Systeme KESO® 1000-2000-4000-CASA. Die neue Decodierung erkennt die richtigen Fräsungen der Schlüssel und ignoriert die "PRE-CUT" (Werksfräsungen).

- Neue "Banner"-Funktion zur Anzeige von wichtigen Nachrichten oder um Nachrichten direkt von der WEB-Seite Silca zu bekommen (PC muss mit Internet verbunden sein).

- Neue Suchfunktion nach ARTIKEL: mindestens 3 Buchstaben plus das Zeichen "*" eingeben, die Suche zeigt alle Serien an, die einen Artikel verwenden, der mit den eingegebenen Buchstaben beginnt. Wenn Sie z.B. "GT1*" eingeben, findet die Funktion alle Serien die einen Artikel verwenden, der mit GT1 beginnt.... Diese Funktion ist auch für die Suche nach Artikel im Silca Transponder Programm verfügbar.

- Verwenden Sie die Verwaltung der MÄRKTE/LAGER von SKP, so werden die Artikel, dieser Sätze auch im Suchfenster farbig markiert.

- Vergleichsartikel aktualisiert.

- Funktion F9 für das Lesen der Barcode der Systeme Kaba® ExperT pluS eingefügt.

- Decodifica per i SN 823, 850 e 860 (chiavi auto Renault® (Clio III), Peugeot®, Citroën® e Toyota®).

- Decodifica SMART per i sistemi KESO® 1000-2000-4000-CASA. La nuova decodifica riconosce le cifrature reali della chiave e ignora i "PRE-CUT" (cifrature di fabbrica).

- Nuova funzione "banner" per visualizzare messaggi importanti oppure per ricevere comunicazioni direttamente dal sito WEB Silca (il PC deve essere collegato ad Internet).

- Nuova funzione di ricerca per ARTICOLO: digitando almeno 3 caratteri più il carattere "*", la ricerca propone tutte le serie che utilizzano un articolo che inizia per i caratteri digitati. Ad esempio digitando "GT1*", la funzione troverà tutte le serie che utilizzano un articolo che inizia per GT1.... Tale funzione è disponibile anche nella ricerca per articolo nel Silca Transponder Program.

- Se si utilizza la gestione dei MERCATI/MAGAZZINI di SKP, gli articoli inclusi in questi insiemi saranno evidenziati con un colore anche nella finestra delle ricerche.

- Aggiornati i comparativi.

- Inserita funzione F9 per la lettura codici a barre dei sistemi Kaba® ExperT pluS.

- Décodage pour les SN 823, 850 et 860 (clés auto Renault® (Clio III), Peugeot®, Citroën® et Toyota®).

- Décodage SMART pour les systèmes KESO® 1000-2000-4000-CASA. Le nouveau décodage identifie les taillages réels de la clé et ignore les pré-perçages (taillés en usine).

- Nouvelle fonction "banner" pour visualiser les messages importants ou recevoir des communications directement du site WEB Silca (le PC doit être raccordé à Internet).

- Nouvelle fonction de recherche par ARTICLE: saisir au moins 3 caractères plus le caractère "*", pour obtenir toutes les séries qui utilisent un article commençant par les caractères entrés. En tapant "GT1*" par exemple, la fonction trouvera toutes les séries utilisant un article commençant par GT1.... Cette fonction est disponible dans la recherche par article dans Silca Transponder Program aussi.

- Si vous utilisez la gestion des MARCHES/MAGAZINS SKP, les articles inclus dans ces ensembles seront surlignés en couleur dans la fenêtre "Rechercher" aussi.

- Comparatifs mis à jour.

- La fonction F9 pour lire les codes barre des systèmes Kaba® ExperT pluS a été insérée.

SILCA KEY PROGRAMS

New Functions

SKP Vers. 20.6.4.xx

 - Decodificación para SN 823, 850 y 860 (llaves para coches Renault® (Clio III), Peugeot®, Citroën® y Toyota®).

- Decodificación SMART para los sistemas KESO® 1000-2000-4000-CASA. La nueva decodificación reconoce los cortes de la llave e ignora los "PRE-CUT" (cortes de fábrica).

- Nueva función "banner" para visualizar mensajes importantes o para recibir comunicaciones directamente desde el sitio WEB Silca (el PC ha de estar conectado a Internet).

- Nueva función de búsqueda por ARTÍCULO: al teclear al menos 3 caracteres más el carácter "*", la búsqueda propone todas las series que usan un artículo que empieza por los caracteres tecleados. Por ejemplo, si tecleamos "GT1*", la función encontrará todas las series que usan un artículo que empieza por GT1.... Dicha función existe también en la búsqueda por artículo en el Silca Transponder Program.

- Si se usa la gestión de los MERCADOS/ALMACENES de SKP, los artículos incluidos en estos conjuntos se resaltarán con un color también en la ventana de búsquedas.

- Comparativos actualizados.

- Función F9 activada para la lectura de los códigos de barras de los sistemas Kaba® ExperT pluS.

 - Descodificação para os SN 823, 850 e 860 (chaves carro Renault® (Clio III), Peugeot®, Citroën® e Toyota®).

- Descodificação SMART para os sistemas KESO® 1000-2000-4000-CASA. A nova descodificação reconhece os cortes reais da chave e ignora os "PRE-CUT" (cortes de fábrica).

- Nova função "banner" para visualizar mensagens importantes ou para receber comunicações directamente do site WEB Silca (o PC deve estar ligado à Internet).

- Nova função de pesquisa por ARTIGO: digitando pelo menos 3 caracteres mais o caracter "*", a pesquisa propõe todas as séries que utilizam um artigo que começa pelos caracteres digitados. Por exemplo, digitando "GT1*", a função encontrará todas as séries que utilizam um artigo que começa por GT1.... Essa função também está disponível na pesquisa por artigo no Silca Transponder Program.

- Utilizando a gestão dos MERCADOS/ARMAZÉNS de SKP, os artigos incluídos nesses conjuntos serão evidenciados por uma cor também na janela das pesquisas.

- Atualizados os comparativos.

- Inserida função F9 para a leitura de códigos de barras dos sistemas Kaba® ExperT pluS.

SILCA CODE PROGRAM

Data Update with 7 new cutting cards

SKP Vers. 20.6.4.xx



Unocode 199



Unocode 299/399



Unocode 399 Evo

Data update with 7 new cutting cards. / Aggiornamento dati con 7 nuove schede. / Datenaktualisierung mit 7 neuen Karten. / Mise à jour des données avec 7 nouvelles fiches. / Actualización datos con 7 fichas nuevas. / Atualização de dados com 7 fichas novas.

New items include: / Tra le novità: / Unter den Neuheiten: / Parmi les nouveautés: / Entre las novedades: / Entre as novidades:

- Abus® (E50)

- Federal® (Avocet ATK)

- Pfaffenhain® (Vitess 1000-2000-4000)

- Pfaffenhain® (Zolit 1000-2000-4000)



Update the software on: / Aggiornare il software di: / Aktualisierung der Software von: / Mettre à jour le logiciel de: / Actualizar el software de: / Atualizar o software de: UC199/UC299/UC399/UC399 EVO.

SILCA TRIAX - QUATTROCODE PROGRAM

Data Update with 23 new series

SKP Vers. 20.6.4.xx



Triax Quattro /
Triax e-code



Quattrocode

Data update with 23 new series. / Aggiornamento dati con 23 nuove serie. / Daten-Aktualisierung mit 23 neuen Serien. / Mise à jour des données avec 23 nouvelles séries. / Actualización datos con 23 series nuevas. / Atualização de dados com 23 séries novas.

New items include: / Tra le novità: / Unter den Neuheiten: / Parmi les nouveautés: / Entre las novedades: / Entre as novidades:

- **Brisant**® ULTION (5+6)
- **Giussani**® (2T - 8W)
- **Hyundai**® (2T - 8W)
- **Hyundai**® (4T - 5W)
- **Hyundai**® (4T - 6W)
- **Hyundai**® Card Key (2T - 5W)
- **Iseo**® R7 (5+6)
- **Kia**® (2T - 8W)
- **Kia**® (4T - 5W)
- **Kia**® (4T - 6W)
- **Kia-Hyundai**® (4T - 6W)
- **Mercedes**® HU64P (2T - 10W)
- **Pfaffenhain**® Vitess 2000 (4P)
- **Pfaffenhain**® Vitess 4000 (4P)
- **Pfaffenhain**® Zolit 2000 (4P)
- **Pfaffenhain**® Zolit 4000 (4P)



Update the software on: / Aggiornare il software di: / Aktualisierung der Software von: / Mettre à jour le logiciel de: / Actualizar el software de: / Atualizar o software de: TRIAX e-code, TRIAX QUATTRO.

SILCA VIPER PROGRAM

Data Update with 13 new series

SKP Vers. 20.6.4.xx



Viper

Data update with 13 new series. / Aggiornamento dati con 13 nuove serie. / Daten-Aktualisierung mit 13 neuen Serien. / Mise à jour des données avec 13 nouvelles séries. / Actualización datos con 13 series nuevas. / Atualização de dados com 13 séries novas.

New items include: / Tra le novità: / Unter den Neuheiten: / Parmi les nouveautés: / Entre las novedades: / Entre as novidades:

- **Hyundai**® (2T - 8W)
- **Hyundai**® (4T - 5W)
- **Hyundai**® (4T - 6W)
- **Hyundai**® Card Key (2T - 5W)
- **Kia**® (2T - 8W)
- **Kia**® (4T - 5W)
- **Kia**® (4T - 6W)
- **Mercedes**® HU64P (2T - 10W)



Update the software on: / Aggiornare il software di: / Aktualisierung der Software von: / Mettre à jour le logiciel de: / Actualizar el software de: / Atualizar o software de: VIPER.

SILCA IDEA AND PRIMA LASER PROGRAM

Data Update with 2 new cutting cards

SKP Vers. 20.6.4.xx



Idea

Data update with 2 new cutting cards. / Aggiornamento dati con 2 nuove schede. / Datenaktualisierung mit 2 neuen Karten. / Mise à jour des données avec 2 nouvelles fiches. / Actualización datos con 2 fichas nuevas. / Atualização de dados com 2 fichas novas.

New items include: / Tra le novità: / Unter den Neuheiten: / Parmi les nouveautés: / Entre las novedades: / Entre as novidades:

- Securemme® (Securmap 11)

- Securemme® (Securmap 24)



Prima Laser



Update the software on: / Aggiornare il software di: / Aktualisierung der Software von: / Mettre à jour le logiciel de: / Actualizar el software de: / Atualizar o software de: IDEA.

SILCA TRANSPONDER PROGRAM

Data Update with 105 new vehicle applications

SKP Vers. 20.6.4.xx



RW4 Plus & RW4

UK STP has been updated with 105 new vehicle applications.

- New software version 03.16.076 for all RW devices.
- Added the DUTCH and HUNGARIAN languages.

IT STP è stato aggiornato con 105 nuove applicazioni auto.

- Nuova versione software 03.16.076 per tutti i dispositivi RW.
- Aggiunte le lingue OLANDESE e UNGHERESE.



Fast Copy Plus / Fast Copy

DE STP wurde mit 105 neuen Auto-Applikationen aktualisiert.

- Neue Softwareversion 03.16.076 für alle RW-Geräte.
- Hinzufügen Sprache: HOLLÄNDISCH und UNGARISCH.

FR STP a été mis à jour avec 105 nouvelles applications auto.

- Nouvelle version software 03.16.076 pour tous les dispositifs transpondeur.
- Ajoutée NÉERLANDAIS et HONGROIS.

ES Se ha actualizado STP con 105 nuevas aplicaciones vehículo.

- Nueva versión de software 03.16.076 para todos los dispositivos RW.
- Agregado el idioma HOLANDEÉS y HÚNGARO.

PT STP foi actualizado com 105 novas aplicações para automóvel.

- Nova versão de software 03.16.076 para todos os dispositivos RW.
- Adicionado a língua HOLANDESA e HÚNGARA.



Update the software on: / Aggiornare il software di: / Aktualisierung der Software von: / Mettre à jour le logiciel de: / Actualizar el software de: / Atualizar o software de: RW4 PLUS, RW4, FAST COPY PLUS, FAST COPY.

SILCA FUTURA PROGRAM

Data Update with new systems

Software Vers. 2.11.0 - db 1.26
App Vers. 1.18





Futura

Data update with new systems. / Aggiornamento dati con nuovi sistemi. / Datena-ktualisierung mit neuen Systemen. / Mise à jour des données avec nouveaux syste-mes. / Actualización de datos con novos sistemas. / Atualização de dados com sistemas novos.

- Abus® (E50)
- Brisant® (Brisant® ULTION (5+6))
- Dom® (Dom® IX5 DAS (pf.038/101))
- Federal® (Avocet® ATK)
- Giussani®/FT® (Giussani® (2T-8W))
- Huf® (Mercedes® HU64P 2014 (2T-10W))
- Hyundai® (Hyundai® (2T-8W))
- Hyundai® (Hyundai® (4T - 5W))
- Hyundai® (Hyundai® (4T - 6W))
- Hyundai® (Hyundai® Card Key (2T - 5W))
- Hyundai®/Kia® (Kia®-Hyundai® (4T-6W))
- Iseo® (Iseo® R7 (5+6))
- Kia® (Kia® - (4T - 6W))
- Kia® (Kia® (2T-8W))
- Kia® (Kia® (4T - 5W))
- Kia® (Kia® (4T - 6W))
- Pfaffenhain® (Vitess 1000-2000-4000)
- Pfaffenhain® (Zolit 1000-2000-4000)
- Pfaffenhain®/Abus® (Pfaffenhain® Vitess 2000 (4P))
- Pfaffenhain®/Abus® (Pfaffenhain® Vitess 4000 (4P))
- Pfaffenhain®/Abus® (Pfaffenhain® Zolit 2000 (4P))
- Pfaffenhain®/Abus® (Pfaffenhain® Zolit 4000 (4P))
- Yale® (Yale® 1000 Series (6P))





 **Remember to update** the Silca.apk and SilcaKeyboard.apk after installing the Software update (see the on board Instructions Manual – Ch 6.2 APP UPDATE (apk)).

 **Ricordarsi di aggiornare** il Silca.apk e SilcaKeyboard.apk dopo l'installazione dell'aggiornamento (vedi le istruzioni nel Manuale D'uso – Capitolo 6.2 AGGIORNAMENTO APP (apk)).

 **Erinnern Sie sich** die Silca.apk und SilcaKeyboard.apk nach der Installation des Updates **zu aktualisieren** (siehe Anleitungen des Betriebs- Handbuches - Kap. UPDATE DER APP (apk)).

 **N'oubliez pas de mettre à jour** Silca.apk et SilcaKeyboard.apk après avoir installé la mise à jour du logiciel (voir le Manuel d'instructions – Ch.6.2 MISE A JOUR APP (apk)).

 **No olvidar actualizar** Silca.apk y SilcaKeyboard.apk después de instalar la versión actualizada del programa (ver indicaciones en el Manual – Ch 6.2 ACTUALIZACIÓN APP (apk)).

 **Lembrar de atualizar** o Silca.apk e SilcaKeyboard.apk após a instalação da atualização (ver as instruções no Manual de Utilização – Capítulo 6.2 ACTUALIZAÇÃO APP (apk)).



SILCA NEWS 08/15

ALL THE NEW KEYS, AUTOMOTIVE SOLUTIONS, KEY CUTTING MACHINES, SOFTWARE UPDATES AND MUCH MORE

Contents

New Keys	1
Empty Shells	2
MySilca app - vers.1.2	3, 4, 5
Silca Futura Program Update	6

My Silca app

The vers. 1.2 is online





New Keys / Chiavi Nuove / Neue Schlüssel / Nouvelles Clés / Llaves Nuevas / Chaves Nuevas

FOR: PER:	CES	EURO LOCKS	FOR / PER
	<p>05</p> <p>CE38W25 CE38W31 CE38W37</p> <p>CE38W26 CE38W32 CE38W38</p> <p>CE38W27 CE38W33 CE38W39</p> <p>CE38W28 CE38W34</p> <p>CE38W29 CE38W35</p> <p>CE38W24 CE38W30 CE38W36</p>	<p>04</p> <p>EU20</p>	<p>CES (D)</p> <p>EURO LOCKS (B)</p> <p>MOIA (I)</p>
FOR: PER:	MOIA		
	<p>Orange head Testa arancione</p> <p>06</p> <p>P486</p> <p>S1491 S1492</p> <p>4+7+3</p> <p>Available in stock</p> <p>MO1RP</p>		<p>01</p> <p>COMMERCIAL GROUP GRUPPO COMMERCIALE PREISEGRUPPE GROUPE COMMERCIAL GRUPO COMMERCIAL GRUPO COMERCIAL</p> <p>www.silca.biz</p>



SILCA EMPTY SHELLS - NEW REFERENCES

ON LINE
ALWAYS
UPDATED
RANGE

 Silca Empty Shells: **3 new keys references** to widen the existing range.

 Silca Empty Shells: **3 nouvelles références** clés qui complètent la gamme existante.

 Silca Empty Shells: **3 nuove referenze** chiavi che implementano la gamma già esistente.

 Silca Empty Shells: **3 nuevas referencias** llaves que completan la gama existente.

 Silca Empty Shells: **3 Schlüssel Referenzen** die das bestehende Angebot implementieren.

 Silca Empty Shells: **3 novas referências** chaves que implementam a gama existente.

Brand	References/Image	Specifications	Vehicle Models*																				
FIAT®	GT15RRS1 	1 Button	<table border="1"> <thead> <tr> <th>MODELS</th> <th>YEAR FROM</th> <th>YEAR TO</th> <th>TRANSPONDER TYPE</th> <th>TRP ID</th> </tr> </thead> <tbody> <tr> <td>VARIOUS MODELS</td> <td>2000</td> <td></td> <td>PH/CR2</td> <td>46</td> </tr> </tbody> </table>	MODELS	YEAR FROM	YEAR TO	TRANSPONDER TYPE	TRP ID	VARIOUS MODELS	2000		PH/CR2	46										
MODELS	YEAR FROM	YEAR TO	TRANSPONDER TYPE	TRP ID																			
VARIOUS MODELS	2000		PH/CR2	46																			
SUZUKI®	SZ11RRS2 	2 Buttons	<table border="1"> <thead> <tr> <th>MODELS</th> <th>YEAR FROM</th> <th>YEAR TO</th> <th>TRANSPONDER TYPE</th> <th>TRP ID</th> </tr> </thead> <tbody> <tr> <td>SWIFT</td> <td>2000</td> <td>2005</td> <td>TEX/CR</td> <td>65</td> </tr> </tbody> </table>	MODELS	YEAR FROM	YEAR TO	TRANSPONDER TYPE	TRP ID	SWIFT	2000	2005	TEX/CR	65										
MODELS	YEAR FROM	YEAR TO	TRANSPONDER TYPE	TRP ID																			
SWIFT	2000	2005	TEX/CR	65																			
TOYOTA®	TOY43CRS2N 	2 Buttons NO battery holder	<table border="1"> <thead> <tr> <th>MODELS</th> <th>YEAR FROM</th> <th>YEAR TO</th> <th>TRANSPONDER TYPE</th> <th>TRP ID</th> </tr> </thead> <tbody> <tr> <td>AURIS</td> <td>2013</td> <td></td> <td>TEX/MA</td> <td>6E</td> </tr> <tr> <td>HILUX</td> <td>2013</td> <td></td> <td>TEX/MA</td> <td>6E</td> </tr> <tr> <td>RAV 4</td> <td>2013</td> <td></td> <td>TEX/MA</td> <td>6E</td> </tr> </tbody> </table>	MODELS	YEAR FROM	YEAR TO	TRANSPONDER TYPE	TRP ID	AURIS	2013		TEX/MA	6E	HILUX	2013		TEX/MA	6E	RAV 4	2013		TEX/MA	6E
MODELS	YEAR FROM	YEAR TO	TRANSPONDER TYPE	TRP ID																			
AURIS	2013		TEX/MA	6E																			
HILUX	2013		TEX/MA	6E																			
RAV 4	2013		TEX/MA	6E																			

* The uses of the keys are purely indicative and may be subject to updates and revisions. / Gli utilizzi delle chiavi sono da considerarsi puramente indicativi e possono essere oggetto di aggiornamenti e revisioni. / Die Abbildung und technischen Daten der Schlüssel sind nicht bindend. Silca behält sich Änderungen am Produkt, die zur Verbesserung beitragen, vor. / Les usages des clés sont purement indicatifs; ils peuvent être mis à jour et revus. / Los usos de las llaves deben considerarse puramente indicativos y pueden ser objeto de actualizaciones y revisiones. / As utilizações das chaves devem ser consideradas puramente indicativas e podem ser objecto de actualizações e revisões.

© Registered Trademarks. / © Marchi Registrati. / © Eingetragene Marken. / © Marques Déposées. / © Marcas Registradas. / © Marcas Registradas.



MySilca app

The version 1.2
is online

Tablet version available!

🇬🇧 MySilca App - version 1.2
A version of MySilca App, optimized also for tablets, has been released on Google Play and App Store for free download.

- > Prompt access to all the necessary information including video tutorials to guide you step-by-step through key cutting operations with Silca machines.
- > Real time updates through push notifications.
- > Overview of all Silca products, with comprehensive and easy to consult materials, and exclusive technical contents to support you in your daily work.

🇫🇷 MySilca App - version 1.2
Une version de MySilca App, optimisée pour tablette, est disponible et téléchargeable gratuitement sur Google Play et App Store.

- > Accès rapide à toutes les informations nécessaires et aussi à des tutoriels vidéo qui vous guideront dans les procédures de copie avec les machines Silca.
- > Mises à jour en temps réel avec des notifications push.
- > Présentation des produits Silca, avec des contenus exhaustifs et conviviaux, et de la documentation technique exclusive pour vous apporter une aide quotidienne.

🇮🇹 MySilca App - versione 1.2
Una versione di MySilca App, ottimizzata anche per tablet, è disponibile e scaricabile gratuitamente da Google Play e App Store.

- > Rapido accesso a tutte le informazioni necessarie fra cui video tutorial che ti guidano passo passo nelle operazioni di copia con le duplicatrici Silca.
- > Aggiornamento in tempo reale tramite notifiche push.
- > Panoramica di tutti i prodotti Silca con contenuti esaustivi e di facile consultazione, ed un'esclusiva documentazione tecnica per fornirti supporto quotidiano.

🇪🇸 MySilca App - versión 1.2
Una versión de MySilca App, optimizada para tabletas, está disponible y descargable gratis desde Google Play y App Store.

- > Acceso rápido a toda la información necesaria y también videos tutoriales que le guían paso a paso en los procedimientos de copia con las máquinas Silca.
- > Actualizaciones en tiempo real con notificaciones push.
- > Visión global de todos los productos Silca con materiales exhaustivos, y una exclusiva documentación técnica, para proporcionarle un soporte diario.

🇩🇪 MySilca App - Version 1.2
Eine Version von MySilca App für Tablet-optimiert steht in Google Play und App Store zur Verfügung: herunterladen Sie es kostenlos.

- > Leichter Zugriff auf alle Informationen auch Tutorfilme, die Sie stufenweise durch den Kopiervorgang mit den Silca-Maschinen führen.
- > Updates in Echtzeit durch Push-Benachrichtigungen.
- > Überblick aller Silca-Produkte mit ausführlichem Infomaterial, und exklusiven technischen Unterlagen für alltäglichen Support.

🇵🇹 MySilca App - versão 1.2
Uma versão da App MySilca, otimizada para tablet, está disponível como um download gratuito de Google Play e App Store.

- > Acesso rápido a todas as informações necessárias e vídeo tutoriais que acompanha o utilizador passo-a-passo nos procedimentos de cópia com as máquinas Silca.
- > Atualizações em tempo real com notificações push.
- > Panorâmica dos todos os produtos Silca com materiais exaustivos, e uma documentação técnica exclusiva para proporcionar um suporte quotidiano.



The new MySilca app video is on YouTube

Click on the link below to watch it

MySilca app video



MySilca app - version 1.2

Daily Updates



MySilca has been developed to meet the needs of key cutters and locksmiths worldwide and provide them real time support and updates.

MySilca wurde entwickelt, um ständig aktuelle Informationen und Support in Echtzeit für die alltägliche Arbeit der Schlüsseldienste weltweit zu liefern.

MySilca ha sido desarrollado para cubrir las necesidades de los duplicadores de llaves y cerrajeros profesionales a nivel mundial, y proporcionarles actualizaciones y soporte en tiempo real.

MySilca è stata sviluppata per fornire aggiornamento e supporto in tempo reale all'attività quotidiana di duplicatori e specialisti in tutto il mondo.

MySilca a été développée pour répondre aux besoins des pros de la reproduction de clés et des serruriers dans le monde entier et pour leur apporter une assistance ainsi que des mises à jour en temps réel.

MySilca foi desenvolvida para fornecer atualização e suporte em tempo real à actividade quotidiana dos duplicadores e dos profissionais da segurança em todo o mundo.



Where you can download MySilca App

Download MySilca for Android and iOS* / Scarica MySilca per Android e iOS* / Herunterladen Sie MySilca für Android und iOS* / Téléchargez MySilca pour Android et iOS* / Descargue MySilca para Android y iOS* / Baixe MySilca para Android e iOS*

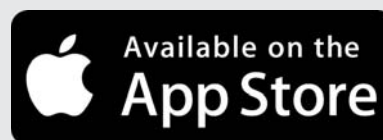
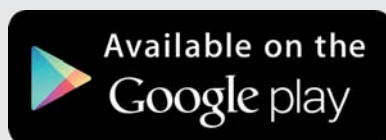

* Minimum software version required: 4.1 for Android - 7.1 for iOS. Compatible with iPhone, iPad and iPod touch. MySilca is optimized for iPhone 5.

* Version de logiciel minimum requise : 4.1 pour Android - 7.1 pour iOS. Compatible avec iPhone, iPad et iPod touch. MySilca est optimisée pour une utilisation sur iPhone 5.

* Versione software minima richiesta: 4.1 per Android - 7.1 per iOS. Compatibile con iPhone, iPad e iPod touch. MySilca è ottimizzata per iPhone 5.

* Mínima versión de software necesaria: 4.1 para Android - 7.1 para iOS. Compatible con iPhone, iPad y iPod touch. MySilca es optimizada para iPhone 5.

* Erforderliche Mindestsoftwareversion: 4.1 für Android - 7.1 für iOS. Kompatibel mit iPhone, iPad und iPod touch. MySilca ist für iPhone 5 optimiert.

* Versão de software mínima necessária: 4.1 para Android - 7.1 para iOS. Compatível com iPhone, iPad e iPod touch. MySilca é otimizada para iPhone 5.



Vehicle Key Finder Pro 2.0

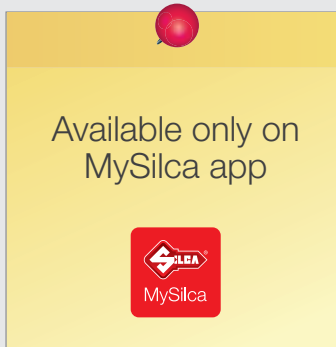
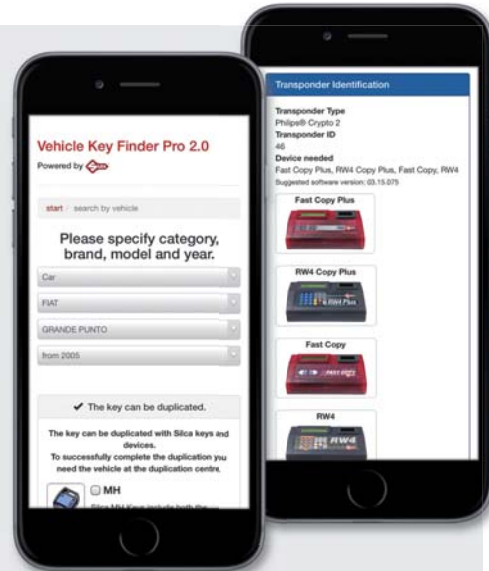

UK This tool has been designed to facilitate your search of automotive keys starting from either a Silca reference or a vehicle make and model. VKF Pro provides you with all the information necessary to copy a vehicle key, such as what transponder and cloning device you need, what key machines you can use to cut the blade, and with the aid of what clamps and software cards.

DE Dieses Tool vereinfacht Ihre Suche des Fahrzeugschlüssels durch eine Silca-Referenz oder die Fahrzeugmarke und Modell. VKF Pro liefert alle zum Schlüssel-Kopieren erforderlichen Informationen, z.B. welchen Transponder und welches Gerät Sie verwenden sollten, welche Kopiermaschine eignet sich besser für den Einschnitt von der Schlüsselstange und mit welchen Klemmen und Softwarekarten.

ES Esta herramienta ha sido diseñada para facilitar la búsqueda de llaves de coche ya sea utilizando la referencia Silca o marca y modelo del coche. VKF Pro, disponible exclusivamente en MySilca, te proporciona toda la información necesaria para copiar una llave de coche, tal como el transponder, dispositivo de clonación, duplicadora de llaves para cortar el perfil, mordazas y fichas a utilizar.

IT Questo strumento è pensato per semplificare la tua ricerca di chiavi automotive a partire da una referenza Silca o dalla marca e dal modello di un veicolo. VKF Pro fornisce tutte le informazioni necessarie a copiare una chiave veicolo, come quale transponder e dispositivo di clonazione utilizzare, quale duplicatrice scegliere per cifrare la canna della chiave e con l'ausilio di quali morsetti e schede software.

FR Cet outil a été conçu pour faciliter votre recherche de clés automobiles à partir d'une référence Silca ou d'une marque et d'un modèle de véhicule. VKF Pro vous donne toutes les informations nécessaires à la reproduction d'une clé de véhicule, telles que le type de transpondeur et l'appareil de reproduction dont vous avez besoin, les machines que vous pouvez utiliser pour tailler une lame et les serrages et logiciels qui peuvent vous aider.

PT Este instrumento é pensado para simplificar a pesquisa de chaves automóveis a partir de uma referência Silca ou da marca e do modelo de um veículo. VKF Pro fornece todas as informações necessárias para copiar uma chave de veículo, como qual transponder e qual dispositivo de clonação utilizar, qual máquina duplicadora escolher para cortar a cana da chave e com o auxílio de quais mordentes e fichas software.



Electronic Key Catalogue



SILCA FUTURA PROGRAM Data Update with new systems

Software Vers. 2.11.3 - db 1.27
App Vers. 1.18





Futura

Data update with new systems. / Aggiornamento dati con nuovi sistemi. / Datena-ktualisierung mit neuen Systemen. / Mise à jour des données avec nouveaux syste-mes. / Actualización de datos con novos sistemas. / Atualização de dados com sistemas novos.

- Cisa® (Cisa® AP3 DA/CA/CE)
- Cisa® (Cisa® Asix Pro (6P))
- Cisa® (C3000)
- Cisa® (C2000 5P 0,44)
- Cisa® (C2000 5P 0,65)





 **Remember to update** the Silca.apk and SilcaKeyboard.apk after installing the Software update (see the on board Instructions Manual – Ch 6.2 APP UPDATE (apk)).

 **Erinnern Sie** sich die Silca.apk und SilcaKeyboard.apk nach der Installation des Updates **zu aktualisieren** (siehe Anleitungen des Betriebs- Handbuches - Kap. UPDATE DER APP (apk)).

 **No olvidar actualizar** Silca.apk y SilcaKeyboard.apk después de instalar la versión actualizada del programa (ver indicaciones en el Manual – Ch 6.2 ACTUALIZACIÓN APP (apk)).

 **Ricordarsi di aggiornare** il Silca.apk e SilcaKeyboard.apk dopo l'installazione dell'aggiornamento (vedi le istruzioni nel Manuale D'uso – Capitolo 6.2 AGGIORNAMENTO APP (apk)).

 **N'oubliez pas de mettre à jour** Silca.apk et SilcaKeyboard.apk après avoir installé la mise à jour du logiciel (voir le Manuel d'instructions – Ch.6.2 MISE A JOUR APP (apk)).

 **Lembrar de atualizar** o Silca.apk e SilcaKeyboard.apk após a instalação da atualização (ver as instruções no Manual de Utilização – Capítulo 6.2 ATUALIZAÇÃO APP (apk)).



SILCA NEWS 09/15

ALL THE NEW KEYS, AUTOMOTIVE SOLUTIONS, KEY CUTTING MACHINES, SOFTWARE UPDATES AND MUCH MORE

Contents

New Keys	1
New Empty Shells	2
Silca Key Programs Update	3
Silca Futura Program Update	4, 5

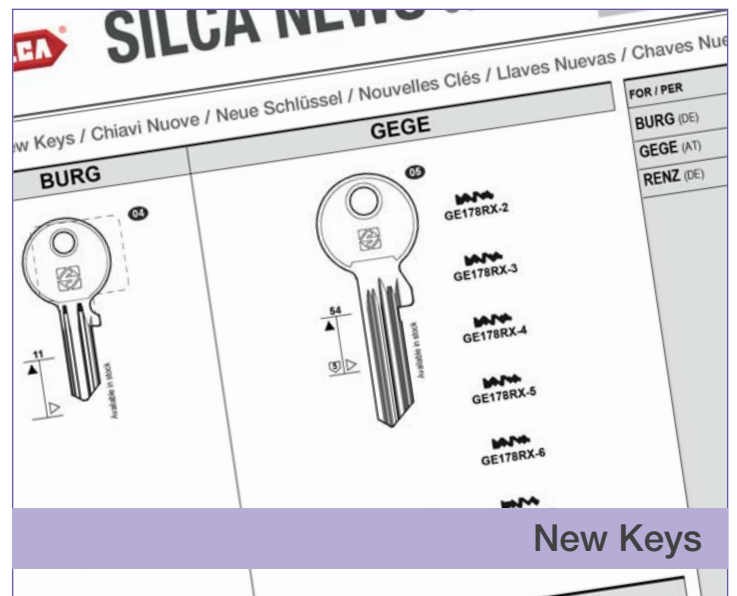



New Keys / Chiavi Nuove / Neue Schlüssel / Nouvelles Clés / Llaves Nuevas / Chaves Nuevas

FOR: PER:	BURG	GEGE	FOR / PER
	<p>BUR62</p>	<p>GE178RX-2</p> <p>GE178RX-3</p> <p>GE178RX-4</p> <p>GE178RX-5</p> <p>GE178RX-6</p> <p>GE178RX-1</p> <p>GE178RX-7</p>	<p>BURG (DE)</p> <p>GEGE (AT)</p> <p>RENZ (DE)</p>
FOR: PER:	RENZ		<p>01</p> <p>COMMERCIAL GROUP GRUPPO COMMERCIALE PREISEGRUPPE GROUPE COMMERCIAL GRUPO COMMERCIAL GRUPO COMERCIAL</p> <p>www.silca.biz</p>
	<p>REN5</p>		

SILCA EMPTY SHELLS - NEW REFERENCES

ON LINE
ALWAYS
UPDATED
RANGE

UK Silca Empty Shells: **2 new keys references** to widen the existing range.

FR Silca Empty Shells: **2 nouvelles références** clés qui complètent la gamme existante.

IT Silca Empty Shells: **2 nuove referenze** chiavi che implementano la gamma già esistente.

ES Silca Empty Shells: **2 nuevas referencias** llaves que completan la gama existente.

DE Silca Empty Shells: **2 Schlüssel Referenzen** die das bestehende Angebot implementieren.

PT Silca Empty Shells: **2 novas referências** chaves que implementam a gama existente.

Brand	References/Image	Specifications	Vehicle Models*										
SMART®	<p>VA2DRS10</p> 	4 Buttons (with panic red button)	<table border="1"> <thead> <tr> <th>MODELS</th> <th>YEAR FROM</th> <th>YEAR TO</th> <th>TRANSPONDER TYPE</th> <th>TRP ID</th> </tr> </thead> <tbody> <tr> <td>FORTWO</td> <td>2007</td> <td>2014</td> <td>PH/CR2</td> <td>46</td> </tr> </tbody> </table>	MODELS	YEAR FROM	YEAR TO	TRANSPONDER TYPE	TRP ID	FORTWO	2007	2014	PH/CR2	46
MODELS	YEAR FROM	YEAR TO	TRANSPONDER TYPE	TRP ID									
FORTWO	2007	2014	PH/CR2	46									
SMART®	<p>YM23RS8</p> 	3 Buttons	<table border="1"> <thead> <tr> <th>MODELS</th> <th>YEAR FROM</th> <th>YEAR TO</th> <th>TRANSPONDER TYPE</th> <th>TRP ID</th> </tr> </thead> <tbody> <tr> <td>FORTWO</td> <td>2003</td> <td>2007</td> <td></td> <td></td> </tr> </tbody> </table>	MODELS	YEAR FROM	YEAR TO	TRANSPONDER TYPE	TRP ID	FORTWO	2003	2007		
MODELS	YEAR FROM	YEAR TO	TRANSPONDER TYPE	TRP ID									
FORTWO	2003	2007											

* The uses of the keys are purely indicative and may be subject to updates and revisions. / Gli utilizzi delle chiavi sono da considerarsi puramente indicativi e possono essere oggetto di aggiornamenti e revisioni. / Die Abbildung und technischen Daten der Schlüssel sind nicht bindend. Silca behält sich Änderungen am Produkt, die zur Verbesserung beitragen, vor. / Les usages des clés sont purement indicatifs; ils peuvent être mis à jour et revus. / Los usos de las llaves deben considerarse puramente indicativos y pueden ser objeto de actualizaciones y revisiones. / As utilizações das chaves devem ser consideradas puramente indicativas e podem ser objecto de actualizações e revisões.

© Registered Trademarks. / © Marchi Registrati. / © Eingetragene Marken. / © Marques Déposées. / © Marcas Registradas. / © Marcas Registradas.



Silca Key Programs

SKP - Web Update

SKP - WEB Update

A new update of the SILCA KEY PROGRAMS software is available to all WEB subscribers.

Check out the "News" section of Silca Key Programs on www.silca.biz to know more.

SKP - AGGIORNAMENTO WEB

È disponibile un nuovo aggiornamento del software SILCA KEY PROGRAMS per tutti gli abbonati WEB.

Consulta la sezione "Novità" di Silca Key Programs sul sito www.silca.biz per saperne di più.

SKP - AKTUALISIERUNG WEB

Für alle WEB Abonnenten ist eine neue Aktualisierung von der Software SILCA KEY PROGRAMS verfügbar.

Sehen Sie den Abschnitt "Neuheiten" von Silca Key Programs auf www.silca.biz, um weitere Informationen zu finden.

SKP - MISE À JOUR WEB

Une nouvelle mise à jour du logiciel SILCA KEY PROGRAMS pour tous les abonnements WEB est disponible.

Consultez la section "Nouveautés" de Silca Key Programs sur notre site www.silca.biz pour en savoir plus.

SKP - ACTUALIZACIÓN WEB

Una nueva actualización del software SILCA KEY PROGRAMS para todos los abonados WEB está disponible.

Visite la sección "Novedades" de Silca Key Programs en el sitio www.silca.biz para más informaciones.

SKP - ATUALIZAÇÃO WEB

Nova atualização do software SILCA KEY PROGRAMS para todos o assinantes WEB está disponível.

Consulte a seção "Novidades" de Silca Key Programs no site www.silca.biz para saber mais.

> More info on all Silca websites

SILCA FUTURA PROGRAM

Data Update with new systems

Software Vers. 2.12.0 - db 1.28
App Vers. 1.19



Futura

Data update with new systems / Aggiornamento dati con nuovi sistemi / Daten-aktualisierung mit neuen Systemen / Mise à jour des données avec nouveaux systèmes / Actualización de datos con novos sistemas / Atualização de dados com sistemas nuevos

- Avocet® Pioneer plus (6P)
- Prefer® S211 (5+5+4)
- Prefer® UL20 (6P)
- Prefer® W551 (4+4+3)
- Trelock® RS430 (4T-7W)
- Ankerslot®
- Burg®
- Euro Locks®
- JPM®
- Maruti Suzuki®

SILCA FUTURA PROGRAM

Data Update with new functions

Software Vers. 2.12.0 - db 1.28
App Vers. 1.19

🇬🇧 New Functions

- New “**Transponder Guide**” function accessible from the Search menu. This function contains all the transponder key copying solutions provided by Silca.
- Use of Silca Remote Service (SRS) Version 1.0.38.5** to register your Futura machine on the Silca server.
- Use of Silca Remote Service (SRS) Version 1.0.38.5** to update your Futura machine in one of the ways described below:
 - **Quick update** (saves time as only the files needed for updating are downloaded onto a blank FAT32 format USB PEN)
 - **Total update (all the files related to updating are downloaded onto a blank FAT32 format USB PEN)**

** The program can be downloaded from the Silca website www.silca.biz; select the Products menu -> Silca Key Programs -> SKP Forms -> Silca Remote Service



Remember to update the Silca.apk and SilcaKeyboard.apk after installing the Software update (see the on board Instructions Manual – Ch 7.3 APP UPDATE (apk)).

🇮🇹 Nuove Funzioni

- Nuova funzione “**Guida Trasponder**” accessibile dal menù Ricerche. Questa funzione raccoglie tutte le soluzioni di copia chiavi trasponder proposte da Silca.
- Utilizzando il Silca Remote Service (SRS) Versione 1.0.38.5** è possibile registrare la macchina Futura nel server Silca.
- Utilizzando il Silca Remote Service (SRS) Versione 1.0.38.5** è possibile aggiornare la macchina Futura nei seguenti modi:
 - **Aggiornamento veloce** (permetterà di risparmiare tempo in quanto verranno scaricati nella USB PEN vuota e in formato FAT32 solo i file necessari per l’aggiornamento)
 - **Aggiornamento totale (verranno scaricati nella USB PEN vuota e in Formato FAT32 tutti i file relativi all’aggiornamento)**

** Il programma è scaricabile dal sito Silca www.silca.biz, selezionando il menù Prodotti -> Silca Key Programs -> SKP Moduli -> Silca Remote Service



Ricordarsi di aggiornare il Silca.apk e SilcaKeyboard.apk dopo l’installazione dell’aggiornamento (vedi le istruzioni nel Manuale D’uso – Capitolo 7.3 AGGIORNAMENTO APP (apk)).

SILCA FUTURA PROGRAM Data Update with new functions

Software Vers. 2.12.0 - db 1.28
App Vers. 1.19

Neue Funktionen

- Neue Funktion **“Transponder Leitlinien”** aufrufbar über das Menü Suchen. Mit dieser Funktion finden Sie alle von Silca vorgeschlagenen Lösungen zum Schlüsselkopieren.
- Mit dem Programm Silca Remote Service (SRS) Version 1.0.38.5** können Sie die Maschine Futura registrieren, wenn sie noch nicht im Silca-Server registriert ist.
- Mit dem Programm Silca Remote Service (SRS) Version 1.0.38.5** können Sie die Maschine Future folgenderweise aktualisieren:
 - **Schnelles Update** (Sie sparen Zeit, weil nur die für das Update erforderlichen Dateien im leeren USB-Stick im Format FAT32 heruntergeladen werden)
 - **Komplettes Update (im leeren USB-Stick werden alle das Update betreffenden Dateien im Format FAT32 heruntergeladen)**

** Sie können das Programm von der Webseite Silca www.silca.biz herunterladen, indem Sie das Menü Produkte -> Silca Key Programs -> SKP Module -> Silca Remote Service aufrufen.



Behebt Probleme, die beim Software-Update der Maschine über das Tablet entstehen können. Für mehr Details lesen sie bitte die Bedienungsanleitung. (Kapitel 7.3 AKTUALISIERUNG APP (Silca.apk)).

Nuevas Funciones

- Nueva función **“Guía Trasponder”** accesible desde el menú Búsquedas. Esta función contiene todas las soluciones para la copia de llaves transponder propuestas por Silca.
- Al usar el Silca Remote Service (SRS) en la Versión 1.0.38.5** se puede registrar la máquina Futura en el servidor Silca.
- Al usar el Silca Remote Service (SRS) en la Versión 1.0.38.5** se puede actualizar la máquina Futura en los siguientes modos:
 - **Actualización rápida** (permite ahorrar tiempo al descargar solamente los archivos necesarios para la actualización en el lápiz USB vacío en el formato FAT32)
 - **Actualización total (se descargan todos los archivos para la actualización en el lápiz USB vacío en el formato FAT32)**

** El programa se descarga en el sitio web de Silca www.silca.biz al seleccionar el menú Productos -> Silca Key Programs -> SKP Módulos -> Silca Remote Service



No olvidar actualizar Silca.apk y SilcaKeyboard.apk después de instalar la versión actualizada del programa (ver indicaciones a bordo máquina integradas en el Manual - Ch 7.3 ACTUALIZACIÓN APP (apk)).

Nouvelles Fonctions

- Nouvelle fonction **“Guide Transpondeur”** accessible dans le menu Rechercher. Cette fonction rassemble toutes les solutions de copie de clés avec transpondeur proposées par Silca.
- Notre Silca Remote Service (SRS) Version 1.0.38.5** vous permettra d'enregistrer la machine Futura si vous ne l'avez pas encore enregistrée dans le serveur Silca.
- Notre Silca Remote Service (SRS) Version 1.0.38.5** vous permettra de mettre la machine Futura à jour comme suit:
 - **Mise à jour rapide** (qui vous permettra de gagner du temps étant donné que seuls les fichiers indispensables pour la mise à jour seront téléchargés dans l'USB PEN vide en format FAT32)
 - **Mise à jour globale (tous les fichiers de la mise à jour seront téléchargés dans le Format FAT32 dans l'USB PEN vide)**

** Le programme est téléchargeable sur notre site Silca www.silca.biz dans le menu Produits -> Silca Key Programs -> SKP Modules -> Silca Remote Service



N'oubliez pas de mettre à jour Silca.apk et Silca Keyboard.apk après avoir installé la mise à jour du logiciel (voir le Manuel d'instructions - Ch.7.3 MISE A JOUR APP (apk)).

Novas Funções

- Nova função **“Guia Trasponder”** à qual se pode ter acesso do menu Pesquisas. Esta função reúne todas as soluções de cópia de chaves transponder propostas pela Silca.
- Utilizando o Silca Remote Service (SRS) Versão 1.0.38.5** é possível registrar a máquina Futura no servidor Silca.
- Utilizando o Silca Remote Service (SRS) Versão 1.0.38.5** é possível atualizar a máquina Futura das seguintes maneiras:
 - **Atualização rápida** (permitirá poupar tempo uma vez que será feito o download para a pen USB vazia e em formato FAT32 somente dos ficheiros necessários para a atualização)
 - **Atualização total (será feito o download para a pen USB vazia e em Formato FAT 32 de todos os ficheiros relativos à atualização)**

** O programa pode ser descarregado do site Silca www.silca.biz, seleccionando o menu Produtos -> Silca Key Programs -> SKP Módulos -> Silca Remote Service



Lembrar de atualizar o Silca.apk e a SilcaKeyboard.apk após a instalação da atualização (ver as instruções no Manual de Utilização - Capítulo 7.3 ATUALIZAÇÃO APP (apk)).



SILCA NEWS 10/15

ALL THE NEW KEYS, AUTOMOTIVE SOLUTIONS, KEY CUTTING MACHINES, SOFTWARE UPDATES AND MUCH MORE

Contents

New Keys	1
Empty Shells	2-3
Vehicle Keys Guide	4
Key Cutting Machines Accessories	5,6
Futura Automotive	7,8
Twister II	9
Silca Key Programs Update	10
Silca Futura Program Update	11,12
AD Nissan® Software	13,14
Silca Events in Europe	15
Coming soon...	16





New Keys / Chiavi Nuove / Neue Schlüssel / Nouvelles Clés / Llaves Nuevas / Chaves Nuevas

FOR: PER:	BKS	TOKOZ	FOR / PER
	<p>1699</p> <p>06</p> <p>Available in stock</p> <p>BK61</p>	<p>1700</p> <p>17</p> <p>Available in stock</p> <p>1701</p> <p>17</p> <p>Available in stock</p> <p>TOZ13</p> <p>TOZ14</p>	<p>BKS (DE)</p> <p>TOKOZ (CZ)</p> <p>UNIVERSAL</p> <p>VAN VAULT (GB)</p>
FOR: PER:	UNIVERSAL	VAN VAULT	
	<p>L</p> <p>02</p> <p>Available in stock</p> <p>UL064L</p>	<p>1213</p> <p>06</p> <p>Available in stock</p> <p>VAV1</p>	
			<p>01</p> <p>COMMERCIAL GROUP GRUPPO COMMERCIALE PREISEGRUPPE GROUPE COMMERCIAL GRUPO COMMERCIAL GRUPO COMERCIAL</p> <p>www.silca.biz</p>



SILCA EMPTY SHELLS - NEW REFERENCES

ON LINE
ALWAYS
UPDATED
RANGE

 Silca Empty Shells: **6 new keys references** to widen the existing range.



 Silca Empty Shells: **6 nouvelles références** clés qui complètent la gamme existante.

 Silca Empty Shells: **6 nuove referenze** chiavi che implementano la gamma già esistente.

 Silca Empty Shells: **6 nuevas referencias** llaves que completan la gama existente.

 Silca Empty Shells: **6 Schlüssel Referenzen** die das bestehende Angebot implementieren.



 Silca Empty Shells: **6 novas referências** chaves que implementam a gama existente.

Brand	References/Image	Specifications	Vehicle Models*																																																		
AUDI®	HU66ARS8 	3 Buttons - Flip	<table border="1"> <thead> <tr> <th>MODELS</th> <th>YEAR FROM</th> <th>YEAR TO</th> <th>TRANSPONDER TYPE</th> <th>TRP ID</th> </tr> </thead> <tbody> <tr><td>A1</td><td>2010</td><td></td><td>MEG/CR</td><td>A2</td></tr> <tr><td>A3</td><td>2003</td><td></td><td>MEG/CR</td><td>A2</td></tr> <tr><td>A6</td><td>2006</td><td></td><td>SOK/CR</td><td>8E</td></tr> <tr><td>A8</td><td>2004</td><td></td><td>PH/CR2</td><td>46</td></tr> <tr><td>Q5</td><td>2009</td><td></td><td>PH/CR3</td><td>50</td></tr> <tr><td>Q7</td><td>2006</td><td></td><td>PH/CR2</td><td>46</td></tr> <tr><td>TT</td><td>2006</td><td></td><td>MEG/CR</td><td>A2</td></tr> </tbody> </table>	MODELS	YEAR FROM	YEAR TO	TRANSPONDER TYPE	TRP ID	A1	2010		MEG/CR	A2	A3	2003		MEG/CR	A2	A6	2006		SOK/CR	8E	A8	2004		PH/CR2	46	Q5	2009		PH/CR3	50	Q7	2006		PH/CR2	46	TT	2006		MEG/CR	A2										
			MODELS	YEAR FROM	YEAR TO	TRANSPONDER TYPE	TRP ID																																														
A1	2010		MEG/CR	A2																																																	
A3	2003		MEG/CR	A2																																																	
A6	2006		SOK/CR	8E																																																	
A8	2004		PH/CR2	46																																																	
Q5	2009		PH/CR3	50																																																	
Q7	2006		PH/CR2	46																																																	
TT	2006		MEG/CR	A2																																																	
<table border="1"> <thead> <tr> <th>MODELS</th> <th>YEAR FROM</th> <th>YEAR TO</th> <th>TRANSPONDER TYPE</th> <th>TRP ID</th> </tr> </thead> <tbody> <tr><td>ASPEN</td><td>2007</td><td>2009</td><td>PH/CR2</td><td>46</td></tr> <tr><td>PACIFICA</td><td>2004</td><td>2008</td><td>PH/CR2</td><td>46</td></tr> <tr><td>PT CRUISER</td><td>2006</td><td>2011</td><td>PH/CR2</td><td>46</td></tr> <tr><td>SEBRING</td><td>2007</td><td>2011</td><td>PH/CR2</td><td>46</td></tr> <tr><td>SEBRING CONVERT</td><td>2007</td><td>2011</td><td>PH/CR2</td><td>46</td></tr> <tr><td>TOWN & COUNTRY</td><td>2004</td><td>2007</td><td>PH/CR2</td><td>46</td></tr> <tr><td>VOYAGER</td><td>2004</td><td>2007</td><td>PH/CR2</td><td>46</td></tr> <tr><td>200</td><td>2011</td><td></td><td>PH/CR2</td><td>46</td></tr> <tr><td>300</td><td>2005</td><td>2008</td><td>PH/CR2</td><td>46</td></tr> </tbody> </table>	MODELS	YEAR FROM	YEAR TO	TRANSPONDER TYPE	TRP ID	ASPEN	2007	2009	PH/CR2	46	PACIFICA	2004	2008	PH/CR2	46	PT CRUISER	2006	2011	PH/CR2	46	SEBRING	2007	2011	PH/CR2	46	SEBRING CONVERT	2007	2011	PH/CR2	46	TOWN & COUNTRY	2004	2007	PH/CR2	46	VOYAGER	2004	2007	PH/CR2	46	200	2011		PH/CR2	46	300	2005	2008	PH/CR2	46			
MODELS	YEAR FROM	YEAR TO	TRANSPONDER TYPE	TRP ID																																																	
ASPEN	2007	2009	PH/CR2	46																																																	
PACIFICA	2004	2008	PH/CR2	46																																																	
PT CRUISER	2006	2011	PH/CR2	46																																																	
SEBRING	2007	2011	PH/CR2	46																																																	
SEBRING CONVERT	2007	2011	PH/CR2	46																																																	
TOWN & COUNTRY	2004	2007	PH/CR2	46																																																	
VOYAGER	2004	2007	PH/CR2	46																																																	
200	2011		PH/CR2	46																																																	
300	2005	2008	PH/CR2	46																																																	
CHRYSLER®	CY24RS2 	2 Buttons	<table border="1"> <thead> <tr> <th>MODELS</th> <th>YEAR FROM</th> <th>YEAR TO</th> <th>TRANSPONDER TYPE</th> <th>TRP ID</th> </tr> </thead> <tbody> <tr><td>ASPEN</td><td>2007</td><td>2009</td><td>PH/CR2</td><td>46</td></tr> <tr><td>PACIFICA</td><td>2004</td><td>2008</td><td>PH/CR2</td><td>46</td></tr> <tr><td>PT CRUISER</td><td>2006</td><td>2011</td><td>PH/CR2</td><td>46</td></tr> <tr><td>SEBRING</td><td>2007</td><td>2011</td><td>PH/CR2</td><td>46</td></tr> <tr><td>SEBRING CONVERT</td><td>2007</td><td>2011</td><td>PH/CR2</td><td>46</td></tr> <tr><td>TOWN & COUNTRY</td><td>2004</td><td>2007</td><td>PH/CR2</td><td>46</td></tr> <tr><td>VOYAGER</td><td>2004</td><td>2007</td><td>PH/CR2</td><td>46</td></tr> <tr><td>200</td><td>2011</td><td></td><td>PH/CR2</td><td>46</td></tr> <tr><td>300</td><td>2005</td><td>2008</td><td>PH/CR2</td><td>46</td></tr> </tbody> </table>	MODELS	YEAR FROM	YEAR TO	TRANSPONDER TYPE	TRP ID	ASPEN	2007	2009	PH/CR2	46	PACIFICA	2004	2008	PH/CR2	46	PT CRUISER	2006	2011	PH/CR2	46	SEBRING	2007	2011	PH/CR2	46	SEBRING CONVERT	2007	2011	PH/CR2	46	TOWN & COUNTRY	2004	2007	PH/CR2	46	VOYAGER	2004	2007	PH/CR2	46	200	2011		PH/CR2	46	300	2005	2008	PH/CR2	46
			MODELS	YEAR FROM	YEAR TO	TRANSPONDER TYPE	TRP ID																																														
ASPEN	2007	2009	PH/CR2	46																																																	
PACIFICA	2004	2008	PH/CR2	46																																																	
PT CRUISER	2006	2011	PH/CR2	46																																																	
SEBRING	2007	2011	PH/CR2	46																																																	
SEBRING CONVERT	2007	2011	PH/CR2	46																																																	
TOWN & COUNTRY	2004	2007	PH/CR2	46																																																	
VOYAGER	2004	2007	PH/CR2	46																																																	
200	2011		PH/CR2	46																																																	
300	2005	2008	PH/CR2	46																																																	
<table border="1"> <thead> <tr> <th>MODELS</th> <th>YEAR FROM</th> <th>YEAR TO</th> <th>TRANSPONDER TYPE</th> <th>TRP ID</th> </tr> </thead> <tbody> <tr><td>ASPEN</td><td>2007</td><td>2009</td><td>PH/CR2</td><td>46</td></tr> <tr><td>PACIFICA</td><td>2004</td><td>2008</td><td>PH/CR2</td><td>46</td></tr> <tr><td>PT CRUISER</td><td>2006</td><td>2011</td><td>PH/CR2</td><td>46</td></tr> <tr><td>SEBRING</td><td>2007</td><td>2011</td><td>PH/CR2</td><td>46</td></tr> <tr><td>SEBRING CONVERT</td><td>2007</td><td>2011</td><td>PH/CR2</td><td>46</td></tr> <tr><td>TOWN & COUNTRY</td><td>2004</td><td>2007</td><td>PH/CR2</td><td>46</td></tr> <tr><td>VOYAGER</td><td>2004</td><td>2007</td><td>PH/CR2</td><td>46</td></tr> <tr><td>200</td><td>2011</td><td></td><td>PH/CR2</td><td>46</td></tr> <tr><td>300</td><td>2005</td><td>2008</td><td>PH/CR2</td><td>46</td></tr> </tbody> </table>	MODELS	YEAR FROM	YEAR TO	TRANSPONDER TYPE	TRP ID	ASPEN	2007	2009	PH/CR2	46	PACIFICA	2004	2008	PH/CR2	46	PT CRUISER	2006	2011	PH/CR2	46	SEBRING	2007	2011	PH/CR2	46	SEBRING CONVERT	2007	2011	PH/CR2	46	TOWN & COUNTRY	2004	2007	PH/CR2	46	VOYAGER	2004	2007	PH/CR2	46	200	2011		PH/CR2	46	300	2005	2008	PH/CR2	46			
MODELS	YEAR FROM	YEAR TO	TRANSPONDER TYPE	TRP ID																																																	
ASPEN	2007	2009	PH/CR2	46																																																	
PACIFICA	2004	2008	PH/CR2	46																																																	
PT CRUISER	2006	2011	PH/CR2	46																																																	
SEBRING	2007	2011	PH/CR2	46																																																	
SEBRING CONVERT	2007	2011	PH/CR2	46																																																	
TOWN & COUNTRY	2004	2007	PH/CR2	46																																																	
VOYAGER	2004	2007	PH/CR2	46																																																	
200	2011		PH/CR2	46																																																	
300	2005	2008	PH/CR2	46																																																	
	CY24RS8 	3 Buttons	<table border="1"> <thead> <tr> <th>MODELS</th> <th>YEAR FROM</th> <th>YEAR TO</th> <th>TRANSPONDER TYPE</th> <th>TRP ID</th> </tr> </thead> <tbody> <tr><td>ASPEN</td><td>2007</td><td>2009</td><td>PH/CR2</td><td>46</td></tr> <tr><td>PACIFICA</td><td>2004</td><td>2008</td><td>PH/CR2</td><td>46</td></tr> <tr><td>PT CRUISER</td><td>2006</td><td>2011</td><td>PH/CR2</td><td>46</td></tr> <tr><td>SEBRING</td><td>2007</td><td>2011</td><td>PH/CR2</td><td>46</td></tr> <tr><td>SEBRING CONVERT</td><td>2007</td><td>2011</td><td>PH/CR2</td><td>46</td></tr> <tr><td>TOWN & COUNTRY</td><td>2004</td><td>2007</td><td>PH/CR2</td><td>46</td></tr> <tr><td>VOYAGER</td><td>2004</td><td>2007</td><td>PH/CR2</td><td>46</td></tr> <tr><td>200</td><td>2011</td><td></td><td>PH/CR2</td><td>46</td></tr> <tr><td>300</td><td>2005</td><td>2008</td><td>PH/CR2</td><td>46</td></tr> </tbody> </table>	MODELS	YEAR FROM	YEAR TO	TRANSPONDER TYPE	TRP ID	ASPEN	2007	2009	PH/CR2	46	PACIFICA	2004	2008	PH/CR2	46	PT CRUISER	2006	2011	PH/CR2	46	SEBRING	2007	2011	PH/CR2	46	SEBRING CONVERT	2007	2011	PH/CR2	46	TOWN & COUNTRY	2004	2007	PH/CR2	46	VOYAGER	2004	2007	PH/CR2	46	200	2011		PH/CR2	46	300	2005	2008	PH/CR2	46
MODELS	YEAR FROM	YEAR TO	TRANSPONDER TYPE	TRP ID																																																	
ASPEN	2007	2009	PH/CR2	46																																																	
PACIFICA	2004	2008	PH/CR2	46																																																	
PT CRUISER	2006	2011	PH/CR2	46																																																	
SEBRING	2007	2011	PH/CR2	46																																																	
SEBRING CONVERT	2007	2011	PH/CR2	46																																																	
TOWN & COUNTRY	2004	2007	PH/CR2	46																																																	
VOYAGER	2004	2007	PH/CR2	46																																																	
200	2011		PH/CR2	46																																																	
300	2005	2008	PH/CR2	46																																																	

* The uses of the keys are purely indicative and may be subject to updates and revisions. / Gli utilizzi delle chiavi sono da considerarsi puramente indicativi e possono essere oggetto di aggiornamenti e revisioni. / Die Abbildung und technischen Daten der Schlüssel sind nicht bindend. Silca behält sich Änderungen am Produkt, die zur Verbesserung beitragen, vor. / Les usages des clés sont purement indicatifs; ils peuvent être mis à jour et revus. / Los usos de las llaves deben considerarse puramente indicativos y pueden ser objeto de actualizaciones y revisiones. / As utilizações das chaves devem ser consideradas puramente indicativas e podem ser objecto de actualizações e revisões.

© Registered Trademarks. / © Marchi Registrati. / © Eingetragene Marken. / © Marques Déposées. / © Marcas Registradas. / © Marcas Registradas.



Brand	References/Image	Specifications	Vehicle Models*				
			MODELS	YEAR FROM	YEAR TO	TRANSPONDER TYPE	TRP ID
MARUTI SUZUKI®	HU133RDRS1 	1 Button	ALTO K10	2010		PH/CR2	46
			A-STAR	2007		PH/CR2	46
			RITZ	2007		PH/CR2	46
			SWIFT	2007		PH/CR2	46
			SX4	2007		PH/CR2	46
			WAGON R	2010		PH/CR2	46
	SZ11RDRS1 	1 Button	VERSA	2007	2010	TEX/CR	65
			WAGON R	2007	2010	TEX/CR	65
			ZEN ESTILO	2007	2010	TEX/CR	65
RENAULT®	NERSD1N 	1 Button NO battery holder	CLIO II	2001	2012	PH/CR2	46
			KANGOO	2002	2010	PH/CR2	46

* The uses of the keys are purely indicative and may be subject to updates and revisions. / Gli utilizzi delle chiavi sono da considerarsi puramente indicativi e possono essere oggetto di aggiornamenti e revisioni. / Die Abbildung und technischen Daten der Schlüssel sind nicht bindend. Silca behält sich Änderungen am Produkt, die zur Verbesserung beitragen, vor. / Les usages des clés sont purement indicatifs; ils peuvent être mis à jour et revus. / Los usos de las llaves deben considerarse puramente indicativos y pueden ser objeto de actualizaciones y revisiones. / As utilizações das chaves devem ser consideradas puramente indicativas e podem ser objecto de actualizações e revisões.

© Registered Trademarks. / © Marchi Registrati. / © Eingetragene Marken. / © Marques Déposées. / © Marcas Registradas. / © Marcas Registradas.

**Car Keys Guide / Guida Chiavi Auto / Marktführer für Autoschlüssel / Guide Clés pour Voitures
Guía Llaves para Coches / Guia Chaves para Carros**

New Updates

1	2	2a	3	3a	3b	E1+E2		6	42+71	72	43 44a	12	15
						GTI COMPATIBLE							
CAR MAKE MODEL	FROM	TO	SILCA REF.	SILCA REF.	SILCA REF.	COPY	GEN.	TRANSP. TYPE	FAST COPY PLUS RW4 PLUS FAST COPY / RW4	FAST COPY PLUS RW4 PLUS	FAST COPY RW4	STP	
For more info on the uses of car keys, refer to the Silca Electronic Key Catalogue:													
HYUNDAI®													
ILOAD	2008		HYN14RT14					PH / CR2	46				
TOYOTA®													
AVENSIS	2000	2011	TOY43AT31					TEX / CR	67				
AVENSIS	2000	2011	TOY43MH	TOY43TE	TOY43FH	Y		TEX / CR	67	Y	P-BOX		
COROLLA	2004	2009	TOY47MH	TOY47TE	TOY47FH	Y		TEX / CR	70	Y	P-BOX		
URBAN CRUISER	2009		TOY43AT31					TEX / CR	67				
URBAN CRUISER	2009		TOY43MH	TOY43TE	TOY43FH	Y		TEX / CR	67	Y	P-BOX		
VOLKSWAGEN®													
CARAVELLE	2003	2009	HU66T24					MEG / CR	A1				
KOMBI	2003	2009	HU66T24					MEG / CR	A1				

**Truck Keys Guide / Guida Chiavi Camion / Marktführer für LKW Schlüssel
Guide Clés pour Camions / Guía Llaves para Camiones / Guia Chaves para Camiões**

New Updates

1	2	2a	3	3a	3b	E1+E2		6	42+71	72	43 44a	12	15
						GTI COMPATIBLE							
TRUCK MAKE MODEL	FROM	TO	SILCA REF.	SILCA REF.	SILCA REF.	COPY	GEN.	TRANSP. TYPE	FAST COPY PLUS RW4 PLUS FAST COPY / RW4	FAST COPY PLUS RW4 PLUS	FAST COPY RW4	STP	
For more info on the uses of truck keys, refer to the Silca Electronic Key Catalogue:													
MAN®													
TGL	2005		HU83T5					MEG	13	Y	Y	MEG	
TGM	2005		HU83T5					MEG	13	Y	Y	MEG	
TGX	2007		HU83T5					MEG	13	Y	Y	MEG	

* The uses of the keys are purely indicative and may be subject to updates and revisions. / Gli utilizzi delle chiavi sono da considerarsi puramente indicativi e possono essere oggetto di aggiornamenti e revisioni. / Die Abbildung und technischen Daten der Schlüssel sind nicht bindend. Silca behält sich Änderungen am Produkt, die zur Verbesserung beitragen, vor. / Les usages des clés sont purement indicatifs; ils peuvent être mis à jour et revus. / Los usos de las llaves deben considerarse puramente indicativos y pueden ser objeto de actualizaciones y revisiones. / As utilizações das chaves devem ser consideradas puramente indicativas e podem ser objecto de actualizações e revisões.

© Registered Trademarks. / © Marchi Registrati. / © Eingetragene Marken. / © Marques Déposées. / © Marcas Registradas. / © Marcas Registradas.

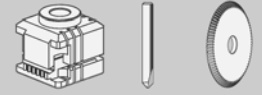
Accessories / Accessori / Zubehör / Accessoires / Accesorios / Acessórios

FOR:
PER:

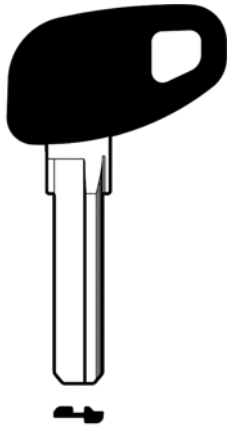
AXA (NL)

OPTIONAL

D745898ZB

Pair of pins 0,9 mm
Coppia spilli 0,9 mm
Stifte 0,9 mm
Epingles 0,9 mm
Par de clavijas 0,9 mm
Par de pinos 0,9 mm

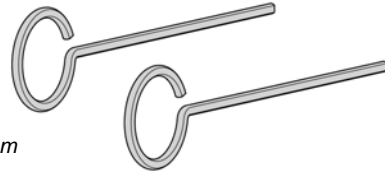

Delivery time NOVEMBER 2015
Disponibilità NOVEMBRE 2015
Lieferbar NOVEMBER 2015
Disponibilité NOVEMBRE 2015
Disponibilidad NOVIEMBRE 2015
Disponibilidade NOVIEMBRO 2015

OPTIONAL

D740372ZB

Tracer point T44
Tastatore T44
Taster T44
Palpeur T44
Palpador T44
Palpador T44

D740448ZB

Cutter F44
Fresa F44
Fräser F44
Fraise F44
Fresa F44
Fresa F44

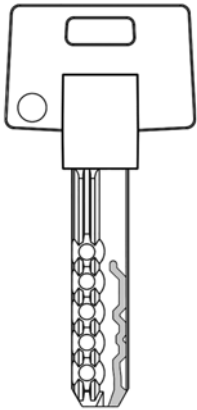

FOR:
PER:

MUL.T.LOCK (IL)

MT5 + (L)
MT5 + (R)



> SW Futura 2.13

STANDARD



D943253ZR

01J Jaw
Ganascia 01J
01J Backe
Mâchoire 01J
Quijada 01J
Garra 01J

STANDARD

D943254ZR

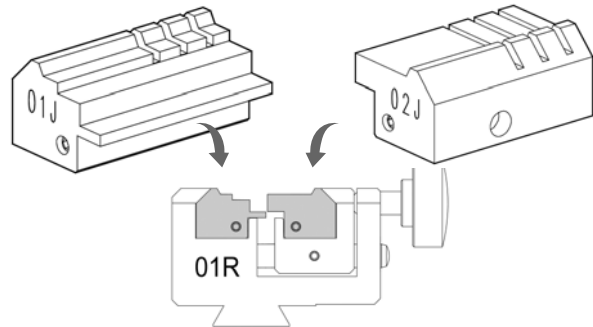
02J Jaw
Ganascia 02J
02J Backe
Mâchoire 02J
Quijada 02J
Garra 02J



OPTIONAL

D745913ZB

Tracer point 05T
Tastatore 05T
Taster 05T
Palpeur 05T
Palpador 05T
Palpador 05T

Delivery time NOVEMBER 2015
Disponibilità NOVEMBRE 2015
Lieferbar NOVEMBER 2015
Disponibilité NOVEMBRE 2015
Disponibilidad NOVIEMBRE 2015
Disponibilidade NOVIEMBRO 2015

OPTIONAL

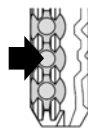
D743746ZB

Cutter 04D
Fresa 04D
Fräser 04D
Fraise 04D
Fresa 04D
Fresa 04D

OPTIONAL

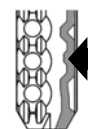
D743744ZB

Cutter 05L
Fresa 05L
Fräser 05L
Fraise 05L
Fresa 05L
Fresa 05L

FOR:
PER: **WINKHAUS (DE)**

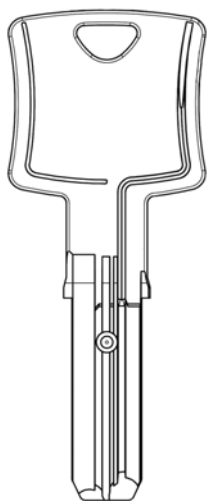

(ON-Tra)
(ON-Tra +)

System protected by a password issued by Silca on receipt of authorization.

Sistema protetto da password rilasciata da Silca a fronte di autorizzazione.

System geschützt durch von Silca geliefertes Password auf Genehmigung.

Système protégé par un password qui est émis par Silca sur autorisation.

Sistema protegido por password que expide Silca contra autorización.

Sistema protegido por uma password emitida por Silca contra a autorização.

SYSTEM	CARD	SN
ON-tra (P1)	3938	1613
ON-tra (P3)	3939	1614
ON-tra + (P1-P1)	3943	1616
ON-tra + (P1-P2)	3944	1617
ON-tra + (P1-P3)	3945	1618
ON-tra + (P1-P4)	3946	1619
ON-tra + (P1-P5)	3947	1620
ON-tra + (P1-P6)	3948	1621
ON-tra + (P1-P7)	3949	1622
ON-tra + (P1-P8)	3950	1623
ON-tra + (P3-P1)	3951	1624
ON-tra + (P3-P2)	3952	1625
ON-tra + (P3-P3)	3953	1626
ON-tra + (P3-P4)	3954	1627
ON-tra + (P3-P5)	3955	1628
ON-tra + (P3-P6)	3956	1629
ON-tra + (P3-P7)	3957	1630
ON-tra + (P3-P8)	3958	1631



OPTIONAL

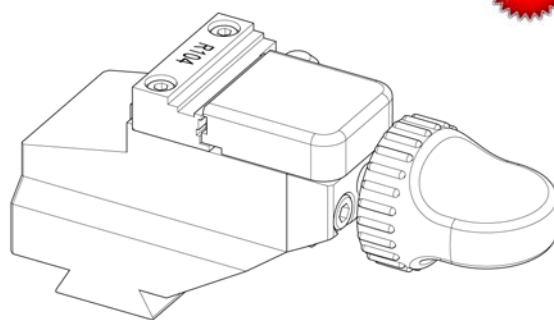

D745811ZB

- Clamp R104
- Morsetto R104
- Spannbacke R104
- Etau R104
- Mordaza R104
- Mordente R104



OPTIONAL



D745840ZB

- Cutter W332 (carbide)
- Fräser W332 (Hartmetall)
- Fraise W332 (au carbure)
- Fresa W332 (metal duro)
- Fresa W332 (metal duro)
- Fresa W332 (metal duro)

Delivery time OCTOBER 2015
Disponibilità OTTOBRE 2015
Lieferbar OKTOBER 2015
Disponibilit  OCTOBRE 2015
Disponibilidad OCTUBRE 2015
Disponibilidade OUTUBRO 2015



Futura Automotive

FUTURA AUTOMOTIVE

Put in motion the future of your vehicle key business

Futura Automotive is the new electronic key machine for cutting flat and laser vehicle keys.

// Integrated tablet with dedicated automotive key database covering over 90% of vehicle models currently available worldwide.

// Dedicated kit of accessories for duplicating vehicle keys.

// Optimized double cutting station (resistant to wear cutters, optical reader, copy by original function, decoding by electric contact, clamp with interchangeable jaws, automatic calibration).

// Color-changing led light of the working area for an immediate process control.

// Compact and easy to carry: perfect for small-sized shops and vans.

// Modern, clean-cut lines, neat-looking design, select components and first-rate materials.

FUTURA AUTOMOTIVE

Metti in moto il futuro del tuo servizio chiavi veicolo

Futura Automotive è la nuova macchina duplicatrice elettronica per chiavi veicolo a cifratura piana e laser.

// Tablet integrato con database dedicato alle chiavi automotive con una copertura di oltre il 90% dei veicoli in circolazione nel mondo.

// Kit di accessori dedicato alla duplicazione di chiavi veicolo.

// Due stazioni per un taglio chiavi ottimizzato (fresse resistenti all'usura, lettore ottico, copia da originale, decodifica tramite contatto elettrico, morsetto con ganasce intercambiabili, calibrazione automatica).

// Luci a led che cambiano colore per un controllo del lavoro immediato.

// Compatta e facile da trasportare: perfetta per negozi di piccole dimensioni e furgoni.

// Design moderno, finiture curate nei minimi dettagli, componenti selezionati e materiali di prima qualità.

FUTURA AUTOMOTIVE

Das Geschäft mit der Fahrzeugschlüsselervielfältigung hat großes Wachstumspotenzial

Futura Automotive ist die neue elektronische Schlüsselräsmaschine für Fahrzeug Flach- und Bahnschlüsseln.

// Integriertes Tablet mit spezieller Fahrzeugschlüssel-Datenbank, die über 90% der weltweiten Fahrzeugmodelle abdeckt.

// Standardzubehör für das Kopieren von Fahrzeugschlüsseln.

// Optimierte Doppelfunktion (verschleißarme Fräser, optischer Laser, Funktion "Kopie vom Original", Decodierung durch elektrischen Kontakt, automatische Kalibrierung, Spannbake mit austauschbaren Adaptern).

// LED-Licht mit wechselnder Farbe für eine sofortige Kontrolle des Schneidvorgangs.

// Kompakt und leicht zu transportieren: perfekt für kleine Geschäfte und Servicefahrzeuge.

// Modernes Design, ausgewählte Komponenten und erstklassige Materialien.

> [More info on all Silca websites](#)



Tablet-integrated automotive key database



Flat key cutting station with fast-rotating clamp

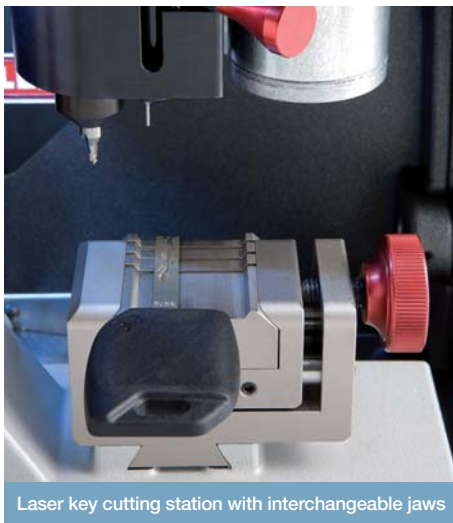

Laser key cutting station with interchangeable jaws

FR FUTURA AUTOMOTIVE

Démarrez votre activité de reproduction de clés de véhicules

Futura Automotive est la nouvelle machine à tailler les clés électronique pour les clés de véhicules plates et à vagues (laser).

// Tablette intégrée avec base de données de clés automobiles, couvrant plus de 90% des modèles de véhicules disponibles dans le monde.

// Kit d'accessoires dédiés à la reproduction de clés de véhicules.

// Deux postes de découpe optimisés (fraises résistantes, lecteur optique, copie par fonction d'origine, décodage par contact électrique, étai avec mâchoires interchangeables, calibrage automatique).

// Voyant LED qui change de couleur, permettant la surveillance des processus en temps réel.

// Compacte et facile à transporter: parfaite pour les petits ateliers et les camions.

// Design moderne, composants intelligents, matériaux haut de gamme et technologies de pointe.

PT FUTURA AUTOMOTIVE

Ponha em movimento o futuro do seu serviço de chaves para veículo

Futura Automotive é a nova máquina duplicadora eletrônica para chaves de veículo de corte plano e laser.

// Tablet integrado com base de dados chaves para veículo que abrange mais de 90% dos veículos em circulação no mundo.

// Kit dos acessórios dedicados à duplicação de chaves de veículo.

// Duas estações para um corte chaves otimizado (fresas resistentes, leitor óptico, cópia de original, descodifica através de contacto eléctrico, mordente com garras trocáveis, calibragem automática).

// Luzes led que mudam de cor para um controlo imediato do trabalho.

// Compacta e fácil de transportar: perfeita para lojas de pequenas dimensões.

// Design moderno, acabamentos cuidados nos mínimos detalhes e materiais de primeira qualidade.

ES FUTURA AUTOMOTIVE

Ponga en marcha el futuro de su negocio de llaves de automoción

Futura Automotive es la nueva duplicadora electrónica para hacer copias de llaves de vehículos planas y de regata.

// Tableta integrada con base de datos de llaves de automoción que abarca el 90% de los modelos de vehículos disponibles en todo el mundo.

// Kit de accesorios dedicados a la duplicación de llaves de vehículos.

// Estación de corte doble optimizada (fresas resistentes al desgaste, lector óptico, duplicado del original, descodifica por contacto eléctrico, mordaza con quijadas intercambiables, calibración automática).

// Lámpara LED que cambia de color para un control del proceso inmediato.

// Compacta y fácil de transportar: perfecta para tiendas de dimensiones pequeñas y furgonetas.

// Diseño moderno y pulcro, componentes selectos, materiales de primera calidad y tecnologías avanzadas.

TYPES OF DUPLICABLE KEYS

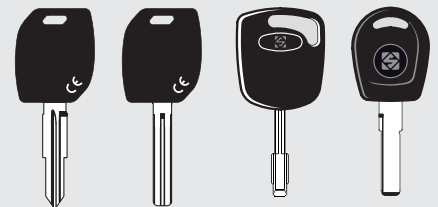

STANDARD EQUIPMENT

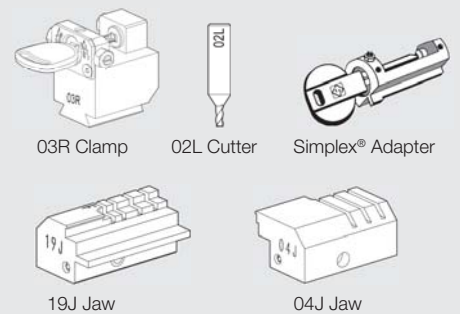

> More info on all Silca websites



Twister II



Reliable, cost-effective,
easy and comfortable to use

TYPES OF DUPLICABLE KEYS

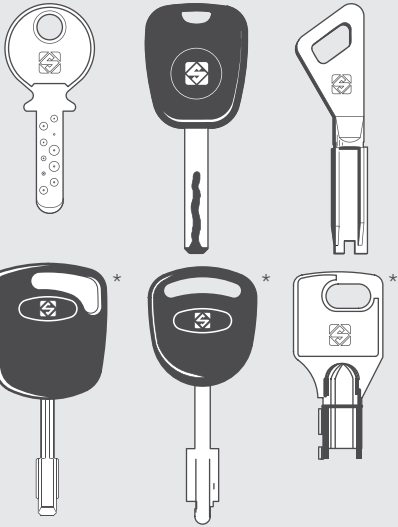

* In order to copy these keys, specific optional accessories are required. / Per duplicare queste tipologie di chiavi è necessario utilizzare gli adattatori opzionali specifici. / Um diese Schlüssell zu kopieren, müssen Sie spezifisches Zubehör verwenden. / Pour reproduire ces clés, il faut utiliser des accessoires optionnels spécifiques. / Para copiar estas llaves hay que utilizar los accesorios opcionales específicos. / Para copiar essas chaves você deve usar acessórios opcionais específicos.

UK Twister II is a mechanical key cutting machine for dimple, laser and Fichet® type keys. With the dedicated optional accessories it can duplicate also tubular keys and vehicle keys for the following brands: Audi®, BMW®, Ford®, Honda®, Mercedes®, Opel-Vauxhall®, Porsche®, Toyota®, Volkswagen®, Volvo® and more.

// [Click here for more info.](#)

DE Twister II ist eine mechanische Schlüsselfräsmaschine für Bohrmulden-, Bahnen- und Fichet®-Schlüssel. Mit dem eigens dafür entwickelten optionalem Zubehör kann sie auch Tubularschlüssel und Fahrzeugschlüssel der folgenden Marken kopieren: Audi®, BMW®, Ford®, Honda®, Mercedes®, Opel-Vauxhall®, Porsche®, Toyota®, Volkswagen®, Volvo® und weitere.

// [Klicken Sie hier für weitere Informationen.](#)

ES Twister II es una duplicadora mecánica para llaves de punto, regata y tipo Fichet® (llaves de seguridad). Utilizando los accesorios opcionales específicos, se pueden duplicar también llaves tubulares y llaves de vehículo para las siguientes marcas: Audi®, BMW®, Ford®, Honda®, Mercedes®, Opel-Vauxhall®, Porsche®, Toyota®, Volkswagen® y Volvo®, entre otras.

// [Para más información clique aquí.](#)

IT Twister II è una duplicatrice meccanica per chiavi punzonate, laser e di tipo Fichet®. Con gli accessori opzionali dedicati è in grado di duplicare anche chiavi tubolari e chiavi veicolo per le seguenti marche: Audi®, BMW®, Ford®, Honda®, Mercedes®, Opel-Vauxhall®, Porsche®, Toyota®, Volkswagen®, Volvo® e molte altre ancora.

// [Per ulteriori informazioni clicca qui.](#)

FR Twister II est une machine à reproduire les clés mécanique pour clés point, laser et de type Fichet®. Les accessoires optionnels dédiés vous permettront de reproduire aussi les clés tubulaires et les clés véhicule des marques suivantes : Audi®, BMW®, Ford®, Honda®, Mercedes®, Opel-Vauxhall®, Porsche®, Toyota®, Volkswagen®, Volvo® et bien d'autres encore.

// [Cliquez ici pour savoir en plus.](#)

PT Twister II é uma máquina duplicadora mecânica para chaves de pontos, laser e de tipo Fichet®. Com os acessórios opcionais dedicados, também pode duplicar chaves tubulares e chaves para veículo para as marcas seguintes: Audi®, BMW®, Ford®, Honda®, Mercedes®, Opel-Vauxhall®, Porsche®, Toyota®, Volkswagen®, Volvo® e muitas outras ainda.

// [Para más información clique aquí.](#)



ENERGY-SAVING LED LIGHT



Silca Key Programs

SKP - Web Update

SKP - WEB Update

A new update of the **SILCA KEY PROGRAMS** software is available to all **WEB** subscribers.

Check out the "News" section of Silca Key Programs on www.silca.biz to know more.

SKP - AGGIORNAMENTO WEB

È disponibile un nuovo aggiornamento del software **SILCA KEY PROGRAMS** per tutti gli abbonati **WEB**.

Consulta la sezione "Novità" di Silca Key Programs sul sito www.silca.biz per saperne di più.

SKP - AKTUALISIERUNG WEB

Für alle **WEB** Abonnenten ist eine neue Aktualisierung von der Software **SILCA KEY PROGRAMS** verfügbar.

Sehen Sie den Abschnitt "Neuheiten" von Silca Key Programs auf www.silca.biz, um weitere Informationen zu finden.

SKP - MISE À JOUR WEB

Une nouvelle mise à jour du logiciel **SILCA KEY PROGRAMS** pour tous les abonnements **WEB** est disponible.

Consultez la section "Nouveautés" de Silca Key Programs sur notre site www.silca.biz pour en savoir plus.

SKP - ACTUALIZACIÓN WEB

Una nueva actualización del software **SILCA KEY PROGRAMS** para todos los abonados **WEB** está disponible.

Visite la sección "Novedades" de Silca Key Programs en el sitio www.silca.biz para más informaciones.

SKP - ATUALIZAÇÃO WEB

Nova atualização do software **SILCA KEY PROGRAMS** para todos o assinantes **WEB** está disponível.

Consulte a seção "Novidades" de Silca Key Programs no site www.silca.biz para saber mais.

> More info on all Silca websites

SILCA FUTURA PROGRAM

Data Update with new systems

Software Vers. 2.13.0 - db 1.29
App Vers. 1.21



Futura

Data update with new systems / Aggiornamento dati con nuovi sistemi / Daten-aktualisierung mit neuen Systemen / Mise à jour des données avec nouveaux systèmes / Actualización de datos con sistemas nuevos / Atualização de dados com novos sistemas

- Bommer®
- Corbin® Corbin TWO (6P)
- Tokai Rika® Subaru Emergency Key (2T-4W)
- Tokoz® Tokoz-TE01
- Union® Union EG

SILCA FUTURA PROGRAM

Data Update with new functions

Software Vers. 2.13.0 - db 1.29
App Vers. 1.21

New Functions

- As an alternative to a tablet -> machine Wi-Fi connection, a USB connection can be used with the cable provided. To activate this connection **enable the Android “Tethering USB” function** from the Settings menu on the Android tablet.
- The Futura machine can be registered through any browser, at the web address: <https://www.silcawebsw.biz/futura/reg/index.html>.
- Silca **periodically distributes Software and Data updates** for Futura. A message will occasionally notify you to check for new updates using one of the connection modes available (see menu Options -> Updates).

Nuove Funzioni

- Come alternativa alla connessione tablet -> macchina via Wi-Fi, è possibile utilizzare la **connessione via cavo USB** in dotazione alla macchina. Per attivare questa connessione, **abilitare la funzione Android “Tethering USB”** dal menù Impostazioni del tablet Android.
- Possibilità di registrare la macchina Futura tramite un browser qualsiasi al seguente indirizzo web: <https://www.silcawebsw.biz/futura/reg/index.html>.
- Silca **distribuisce periodicamente aggiornamenti** Software e Dati per Futura. Un messaggio ti avviserà periodicamente di verificare la presenza di nuovi aggiornamenti utilizzando una delle modalità di connessione disponibili (vedi menu Opzioni -> Aggiornamenti).



Remember to update the Silca.apk and SilcaKeyboard.apk after installing the Software update (see the on board Instructions Manual – Ch 7.3 APP UPDATE (apk)).



Ricordarsi di aggiornare il Silca.apk e SilcaKeyboard.apk dopo l'installazione dell'aggiornamento (vedi le istruzioni nel Manuale D'uso – Capitolo 7.3 AGGIORNAMENTO APP (apk)).

SILCA FUTURA PROGRAM

Data Update with new functions

Software Vers. 2.13.0 - db 1.29
App Vers. 1.21

Neuen Funktionen

- Als Alternative zu einem Tablet -> Maschine WLAN-Verbindung kann eine **USB-Verbindung** mit dem mitgelieferten Kabel genutzt werden. Um diese Verbindung zu **aktivieren wählen Sie die "Tethering USB" Funktion** in den Einstellungen im Android Tablet aus.
- Die Futura Maschine kann über jeden Browser registriert werden, unter der Web-Adresse: <https://www.silcaweb-sw.biz/futura/reg/index.html>.
- Silca **veröffentlicht regelmäßig optionale Software- und Datenupdates** für die Futura. Eine Mitteilung wird Sie darüber informieren, damit Sie Ihre Software nach neuen Aktualisierungen überprüfen können (siehe Menü Optionen -> Updates).



Behebt Probleme, die beim Software-Update der Maschine über das Tablet entstehen können. Für mehr Details lesen sie bitte die Bedienungsanleitung. (Kapitel 7.3 AKTUALISIERUNG APP (Silca.apk)).

Nouvelles Fonctions

- En alternative à une connexion Wi-Fi tablette -> machine, une connexion USB peut être utilisée avec le câble prévu à cet effet. Pour mettre en place cette connexion, **activez la fonction Android «Modem USB»** dans le menu des Paramètres sur la tablette Android.
- La machine Futura peut être enregistrée avec n'importe quel navigateur, à l'adresse web: <https://www.silcaweb-sw.biz/futura/reg/index.html>.
- Silca **diffuse périodiquement des mises à jour** de Logiciel et de données pour Futura. Un message vous informera de temps à autre de la disponibilité de nouvelles mises à jour via l'un des modes de connexion disponibles (cf. menu Options -> Mises à jour).



N'oubliez pas de mettre à jour Silca.apk et Silca Keyboard.apk après avoir installé la mise à jour du logiciel (voir le Manuel d'instructions – Ch.7.3 MISE A JOUR APP (apk)).

Nuevas Funciones

- Como una alternativa a la conexión tablet -> máquina por Wi-Fi, también se podrá realizar una conexión **usando el cable USB** presente en el equipamiento. Para activar esta conexión se debe **habilitar la función "Tethering USB"** en el menú Ajustes en la Tablet Android.
- La máquina Futura se podrá registrar usando cualquier navegador, en la siguiente dirección: <https://www.silcaweb-sw.biz/futura/reg/index.html>.
- **Periódicamente Silca distribuye actualizaciones** de software y datos para la Futura. Un mensaje notificará ocasionalmente para que verifiquen por nuevas actualizaciones usando uno de los modos de conexión disponibles (ver menú Opciones -> Actualizaciones).



No olvidar actualizar Silca.apk y SilcaKeyboard.apk después de instalar la versión actualizada del programa (ver indicaciones a bordo máquina integradas en el Manual – Ch 7.3 ACTUALIZACIÓN APP (apk)).

Novas Funções

- Como alternativa à ligação tablet -> máquina via Wi-Fi, é possível utilizar a **ligação via cabo USB** entregue com a máquina. Para activar esta ligação, **habilitar a função Android "Tethering USB"** do menu Programações do tablet Android.
- Possibilidade de registar a máquina Futura através de um browser qualquer ao seguinte endereço: <https://www.silcaweb-sw.biz/futura/reg/index.html>.
- A Silca **distribui periodicamente atualizações** Software e Dados para Futura. Uma mensagem vai avisar periodicamente o utilizador para que verifique a presença de novas atualizações utilizando uma das modalidades de ligação disponíveis (ver o menu Opções -> Atualizações).



Lembrar de atualizar o Silca.apk e a SilcaKeyboard.apk após a instalação da atualização (ver as instruções no Manual de Utilização – Capítulo 7.3 ATUALIZAÇÃO APP (apk)).



Nissan® 20 Digit Pincode Bypass Software ADS198SD for Smart Dongle - Code D745387AD

Requires Nissan® ADS197 Software for Key Programming

September 2015



 Advanced Diagnostics are pleased to announce the release of a FREE software update for Nissan® PINCODE Read software ADS198SD, specifically developed for use on the Smart Dongle.

For more information, click here.

 Advanced Diagnostics ha rilasciato un nuovo aggiornamento gratuito per il software di lettura codici pin per veicoli Nissan® (codice ADS198SD). L'aggiornamento è stato sviluppato specificamente per l'utilizzo con Smart Dongle.

Per ulteriori informazioni clicca qui.



 Advanced Diagnostics freut sich das Software Update für die PINCODE Reader ADS198SD, dass speziell für den Smart Dongle entwickelt, vorstellen zu dürfen.

Für weitere Auskünfte, klicken Sie hier.

 Advanced Diagnostics a le plaisir de vous annoncer la sortie d'une mise à jour GRATUITE du logiciel de lecture du code PIN Nissan® (code ADS198SD), spécialement destinée à une utilisation sur le Smart Dongle.

Pour avoir de plus amples informations, cliquez ici.

 Advanced Diagnostics y Silca tiene el placer de anunciarle el lanzamiento de una actualización gratuita para el software ADS198SD para lectura de PIN CODE de Nissan®, especialmente diseñado para Smart Dongle.

Para más informaciones, clique aquí.

 Advanced Diagnostics realizou uma nova atualização gratuita para o software de leitura dos códigos pin para veículos Nissan® (código ADS198SD).

A atualização foi desenvolvida expressamente para ser utilizada com Smart Dongle.

Para mais informações clicar aqui.

DETAILS OFFER

Cable	ADC250 or ADC251
Dongle	Smart Dongle
Software category	Specials
Other software required	ADS197 & ADS198SD (will not work on ADC198)
Smart card	Smart Dongle

www.silca.biz - www.silca-automotive.com - www.advanced-diagnostics.com



Nissan® Software Applications

Nissan® Pincode Bypass for ADS198SD - Used with Nissan® 2013 - ADS197

TABLE

							
Nissan® Altima (Proximity) 2013 Onwards - 4 Door	✓	✓	✓	✓	ADC250 or ADC251	Smart Dongle	✗
Nissan® Altima (Proximity) 2013 Onwards - 2 Door	✓	✓	✓	✓	ADC250 or ADC251	Smart Dongle	✗
Nissan® Qashqai (Blade & Prox) 2014 Onwards	✓	✓	✓	✓	ADC250 or ADC251	Smart Dongle	✗
Nissan® Rogue (Proximity) 2014 Onwards	✓	✓	✓	✓	ADC250 or ADC251	Smart Dongle	✗
Nissan® Teana (Proximity) 2013 Onwards	✓	✓	✓	✓	ADC250 or ADC251	Smart Dongle	✗
Nissan® X- Trail (Proximity) 2014 Onwards	✓	✓	✓	✓	ADC250 or ADC251	Smart Dongle	✗
Infiniti® QX50 (Proximity) 2014 Onwards	✓	✓	✓	✓	ADC250 or ADC251	Smart Dongle	✗
Infiniti® QX60 (Proximity) 2014 Onwards	✓	✓	✓	✓	ADC250 or ADC251	Smart Dongle	✗
Infiniti® Q50 (Proximity) 2014 Onwards	✓	✓	✓	✓	ADC250 or ADC251	Smart Dongle	✗
Infiniti® JX35 (Proximity) 2012 - 2014	✓	✓	✓	✓	ADC250 or ADC251	Smart Dongle	✗

© All the brand and product names mentioned in this flyer are registered trademarks exclusive property of authorized manufacturers. Said trademarks or trade names are nominated only for the purposes of information in order to be rapidly identified.

© Tutti i marchi o denominazioni commerciali di prodotto menzionati nel presente documento sono di proprietà esclusiva dei produttori autorizzati. I sopracitati marchi o denominazioni commerciali di prodotto sono indicati a esclusivo titolo informativo o destinati ad uso formativo e con lo scopo di facilitarne l'identificazione.

© Alle Marken oder Handelsbezeichnungen der in dieser Broschüre erwähnten Produkte sind ausschließliches Eigentum der zugelassenen Hersteller. Die oben angeführten Marken oder Handelsbezeichnungen dienen nur zur Information, Schulung und einfacheren Identifizierung.

© Toutes les marques ou appellations commerciales de produits mentionnés dans cette brochure appartiennent exclusivement aux producteurs autorisés. Les dites marques ou appellations commerciales de produits sont données à titre purement informatif ou destinées à un usage formatif dans le but d'en faciliter l'identification.

© Todas las marcas o denominaciones comerciales de productos mencionadas en este folleto son de propiedad exclusiva de los productores autorizados. Dichas marcas o denominaciones comerciales de productos se formulan a título meramente informativo o se citan para uso formativo y con el fin de facilitar su identificación.

© Todas as marcas ou denominações comerciais de produto citadas neste folheto são propriedade exclusiva dos fabricantes autorizados. As atrás referidas marcas ou denominações comerciais de produto são indicadas exclusivamente a nível de informação ou destinadas a uso formativo e a fim de facilitar a sua identificação.



Silca Events in Europe



2-4/10

MLA EXPO 15
MASTER LOCKSMITHS ASSOCIATION

MLA Expo 2015

in Telford - The International Centre
UNITED KINGDOM

The UK's largest exhibition trade show for the locksmithing and security industry

Silca and its distributor Aldridge Security have attended this year's edition of MLA Expo, the trade show for locksmiths, key cutters and professionals of the security industry organised by the Master Locksmiths Association.

Visitors of the booth appreciated and tested first-hand the products exhibited, showing particular interest in the cutting-edge solutions offered by Silca and Advanced Diagnostics for the automotive key duplication and programming business. The display was so successful that it received the award for the best stand of the expo.

Check out our website for more photos of the event.

> More info on www.locksmiths.co.uk/mla-expo



3-5/11

SICUREZZA

Sicurezza

in Rho, Milan - Fiera Milano
ITALY

The leading international event in Italy in the sectors of security and fire-prevention

Silca is attending the 2015 edition of Sicurezza, the most important trade show in Italy for the security and fire prevention industry.

The growing demand for advanced security solutions is paving the way for a promising exhibition, where Silca is going to present all of its latest tools and devices dedicated to the automotive key duplication business, its cutting-edge mechanical and electronic key machines, and its wide range of high-quality key blanks: a complete and reliable offer that covers any customers' need.

Come visit our stand at Pavilion 22, Booth N30.

> More info on www.sicurezza.it



**SILCA
INTRODUCES
A NEW CONCEPT**

**A NEW WAY TO OFFER
THE KEY DUPLICATION SERVICE**

**INNOVATIVE SMART ABLE TO FOLLOW
YOUR BUSINESS**

IS COMING SOON...

> Follow the countdown on all Silca websites and on our YouTube page

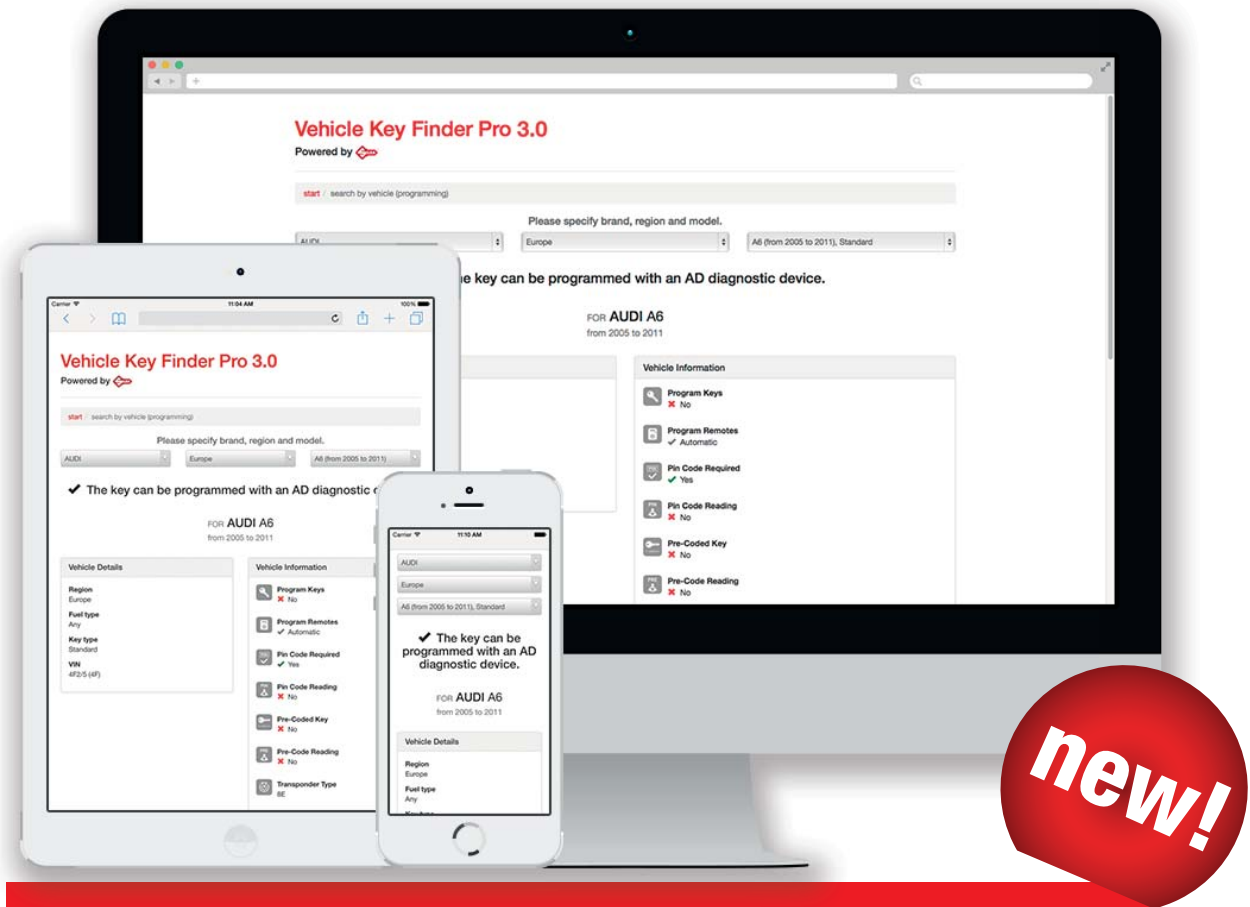

The new **Vehicle Key Finder 3.0** is available for Desktop Tablet and Mobile.

Stay Tuned!

VKF 3.0

IS COMING SOON!



SILCA NEWS 11/15

ALL THE NEW KEYS, AUTOMOTIVE SOLUTIONS, KEY CUTTING MACHINES, SOFTWARE UPDATES AND MUCH MORE





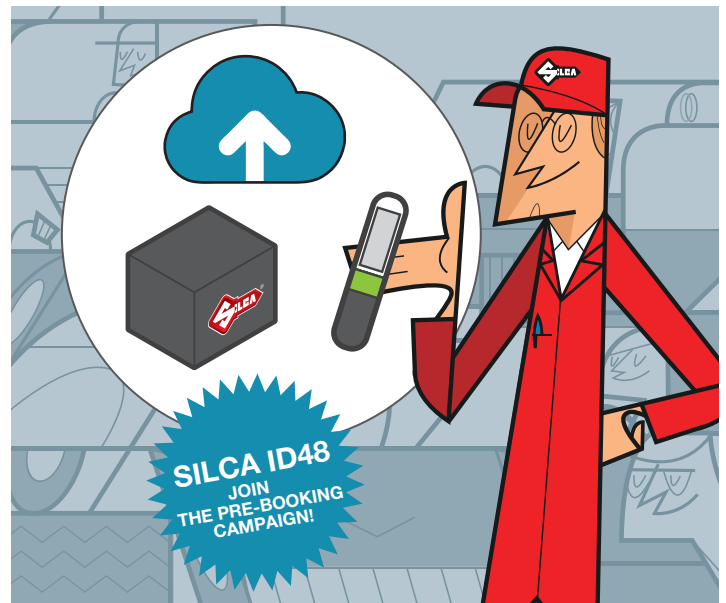





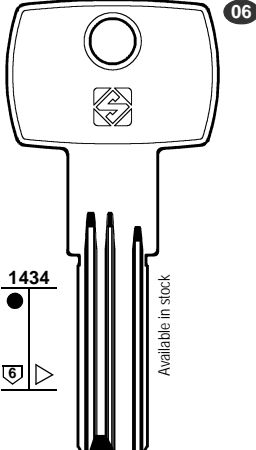

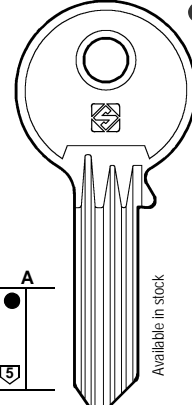

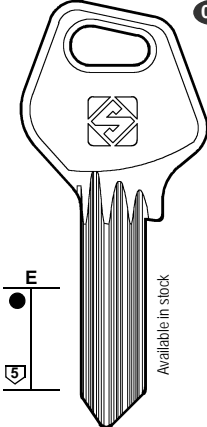

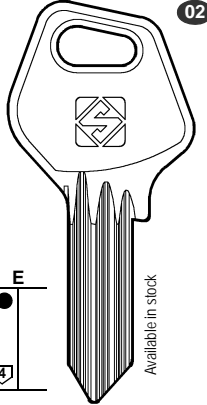

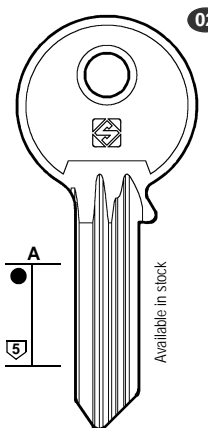
Contents

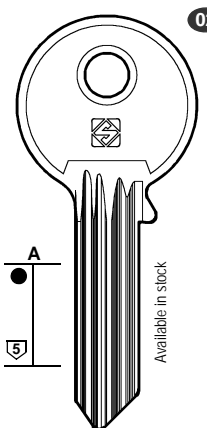
New Keys	1
Vehicle Keys Guide	2,6
Token Solution	7,8
Futura Automotive Token	9
Silca ID48	10
Smart Aerial	11
Silca Key Programs Update	12
New Key Cutting Machines Catalogues	13
Silca @ Trade Shows in Italy	14

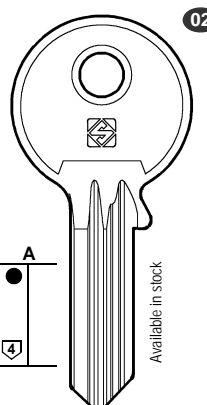

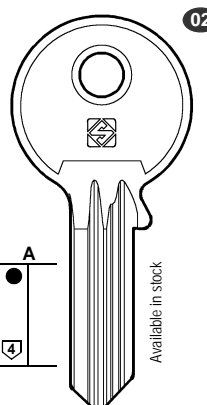

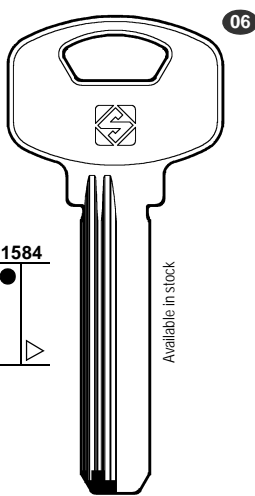









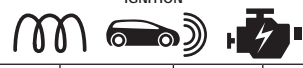



New Keys / Chiavi Nuove / Neue Schlüssel / Nouvelles Clés / Llaves Nuevas / Chaves Nuevas

FOR: PER:	P.C. (CORTELLEZZI)				FOR / PER	
<p>HOK</p>  <p>HOK2R</p>  	<p>PC26</p>  <p>PC26</p> 	<p>PC27</p>  <p>PC27</p> 	<p>PC28</p>  <p>PC28</p> 		<p>HOK (TR)</p> <p>P.C. (CORTELLEZZI) (IT)</p> <p>YALE (IT)</p>	<p>01</p> <p>COMMERCIAL GROUP GRUPPO COMMERCIALE PREISEGRUPPE GROUPE COMMERCIAL GRUPO COMMERCIAL GRUPO COMERCIAL</p> <p>www.silca.biz</p> 
<p>P.C. (CORTELLEZZI)</p>  <p>PC31R</p> 	<p>PC33</p>  <p>PC33</p> 	<p>PC33R</p>  <p>PC33R</p> 	<p>PC32R</p>  <p>PC32R</p> 	<p>YALE</p>  <p>YA99R</p>  		



Car Keys Guide / Guida Chiavi Auto / Marktführer für Autoschlüssel / Guide Clés pour Voitures
 Guía Llaves para Coches / Guia Chaves para Carros

New Updates

1	2	2a	3	3a	3b	E1+E2		6	42+71	72	43 44a	12	15
						GTI COMPATIBLE		IGNITION 					
CAR MAKE MODEL	FROM	TO	SILCA REF.	SILCA REF.	SILCA REF.	COPY	GEN.	TRANSP. TYPE	FAST COPY PLUS RW4 PLUS FAST COPY / RW4	FAST COPY PLUS RW4 PLUS	FAST COPY RW4	STP	
													

For more info on the uses of car keys, refer to the Silca Electronic Key Catalogue:



















AUDI®													
A1	2010		HU66ARS8					MEG / CR	48-A2				
A1	2010							MEG / CR	48-A2				
A3	2003							MEG / CR	48-A2				
A4	2004							MEG / CR	48-A2				
A6	2004	2006						MEG / CR	48-A2				
ALLROAD	2006							MEG / CR	48-A2				
TT	2003		HU66ARS8					MEG / CR	48-A2				
TT	2006							MEG / CR	48-A2				
BENTLEY®													
ARNAGE	1998	2004						PH / CR	44				
CONTINENTAL GT	2003	2008						PH / CR2	46				
CONTINENTAL GTC	2003	2009	SMART KEY					PH / CR2	46				
CONTINENTAL GTC	2003	2009						PH / CR2	46				
CONTINENTAL SUPER SPORT	2003	2009	SMART KEY					PH / CR2	46				
CADILLAC®													
STS	2005	2012	SMART KEY					PH / CR2	46				
CITROËN®													
C3 PICASSO	2008		VA2T14	VA2FH	VA2TE		Y	PH / CR2	46				
C4 PICASSO	2013		SMART KEY					PH / CR2	46				
DS3	2010		VA2T14	VA2FH	VA2TE		Y	PH / CR2	46				
DS4	2011		SMART KEY					PH / CR2	46				
DS4	2011		VA2T14	VA2FH	VA2TE		Y	PH / CR2	46				
DAIHATSU®													
BE-GO	2006		TOY41RMH	TOY41RTE	TOY41RFH	Y		TEX / CR	67	Y	P-BOX		
BE-GO	2006			TOY41RTE	TOY41RFH		Y	TEX / CR	67				
BOON	2005		TOY41RMH	TOY41RTE	TOY41RFH	Y		TEX / CR	67	Y	P-BOX		
BOON	2005			TOY41RTE	TOY41RFH		Y	TEX / CR	67				
COO	2005		TOY41RMH	TOY41RTE	TOY41RFH	Y		TEX / CR	67	Y	P-BOX		
COO	2005			TOY41RTE	TOY41RFH		Y	TEX / CR	67				
STORIA	2005			TOY41RTE	TOY41RFH		Y	TEX / CR	67				
FIAT®													
ALBEA	2002							MEG / CR	48				
FORD EU®													
EDGE	2011	2013						TEX / MA	6E				



Car Keys Guide / Guida Chiavi Auto / Marktführer für Autoschlüssel / Guide Clés pour Voitures
 Guía Llaves para Coches / Guia Chaves para Carros











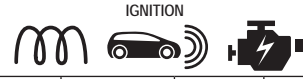

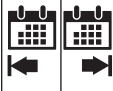

New Updates

1	2	2a	3	3a	3b	E1+E2		6	42+71	72	43 44a	12	15
						GTI COMPATIBLE		IGNITION 					
CAR MAKE MODEL	FROM	TO	SILCA REF.	SILCA REF.	SILCA REF.	COPY	GEN.	TRANSP. TYPE	FAST COPY PLUS RW4 PLUS FAST COPY / RW4	FAST COPY PLUS RW4 PLUS	FAST COPY RW4	STP	
													
For more info on the uses of car keys, refer to the Silca Electronic Key Catalogue: 													
FORD EU®													
GALAXY	2010	2014	SMART KEY					TEX / MA	6E				
GALAXY	2010	2014						TEX / MA	6E				
GALAXY	2015		SMART KEY					PH / CR3	47				
HYUNDAI®													
AMICA	1997	2001	HYN10MH	HYN10TE	HYN10FH	Y		TEXAS	4C	Y	P-BOX		
AMICA	1997	2001	HYN10T4	HYN10TE	HYN10FH		Y	TEXAS	4C				S6
AMICA	2004	2008	HYN10MH	HYN10TE	HYN10FH	Y		PH / CR2	46	Y	P-BOX		
AMICA	2004	2008	HYN10T14	HYN10TE	HYN10FH		Y	PH / CR2	46				
TRAJET	1999	2007	HYN7RMH	HYN7RTE	HYN7RFH	Y		PH / CR2	46	Y	P-BOX		
TRAJET	1999	2007		HYN7RTE	HYN7RFH		Y	PH / CR2	46				
JAGUAR®													
F-TYPE	2013		SMART KEY					PH / CR2	46				
XF	2008	2013	SMART KEY					PH / CR2	46				
XJ	2009		SMART KEY					PH / CR2	46				
XK	2006		SMART KEY					PH / CR2	46				
XKR	2006		SMART KEY					PH / CR2	46				
MINI®													
CABRIO	2004	2008						PH	73				
CABRIO	2009		SMART KEY					PH / CR2	46				
CLUBMAN	2007	2014	SMART KEY					PH / CR2	46				
CONVERTIBLE	2004	2008						PH	73				
CONVERTIBLE	2009		SMART KEY					PH / CR2	46				
COOPER	2001	2006						PH	73				
COOPER S	2001	2006						PH	73				
COUNTRYMAN	2010		SMART KEY					PH / CR2	46				
COUPE	2012		SMART KEY					PH / CR2	46				
HATCH	2006	2013	SMART KEY					PH / CR2	46				
ONE	2001	2006						PH	73				
PACEMAN	2013		SMART KEY					PH / CR2	46				
NISSAN®													
ALMERA	2003	2006	NSN14MH	NSN14TE	NSN14FH	Y		PH / CR2	46	Y	P-BOX		
ALMERA	2003	2006	NSN14T14	NSN14TE	NSN14FH		Y	PH / CR2	46				
CUBE	2002	2013	NSN14MH	NSN14TE	NSN14FH	Y		PH / CR2	46	Y	P-BOX		
CUBE	2002	2013	NSN14T14	NSN14TE	NSN14FH		Y	PH / CR2	46				
CUBE	2009	2013	SMART KEY					PH / CR2	46				



Car Keys Guide / Guida Chiavi Auto / Marktführer für Autoschlüssel / Guide Clés pour Voitures
 Guía Llaves para Coches / Guia Chaves para Carros















New Updates

1	2	2a	3	3a	3b	E1+E2		6	42+71	72	43 44a	12	15
						GTI COMPATIBLE							
CAR MAKE MODEL	FROM	TO	SILCA REF.	SILCA REF.	SILCA REF.	COPY	GEN.	TRANSP. TYPE	FAST COPY PLUS RW4 PLUS FAST COPY / RW4	FAST COPY PLUS RW4 PLUS	FAST COPY RW4	STP	
													
For more info on the uses of car keys, refer to the Silca Electronic Key Catalogue: 													
PEUGEOT®													
2008	2013		HU83T14	HU83TE	HU83FH		Y	PH / CR2	46				
208	2012		HU83T14	HU83TE	HU83FH		Y	PH / CR2	46				
4007	2007	2012	SMART KEY					PH / CR2	46				
4007	2007	2012						PH / CR2	46				
408	2010		HU83MH	HU83TE	HU83FH	Y		PH / CR2	46	Y	P-BOX		
408	2010		HU83T14	HU83TE	HU83FH		Y	PH / CR2	46				
SEAT®													
ALHAMBRA	2010							MEG / CR	48-A3				
ALTEA	2004	2008	HU66T23	HU66TE	HU66FH			MEG / CR	48-A3				
ALTEA	2004	2008	HURSA2					MEG / CR	48-A3				
ALTEA	2004	2008	HURSA8					MEG / CR	48-A3				
ALTEA	2008							MEG / CR	48-A3				
ALTEA XL	2006	2008	HU66T23	HU66TE	HU66FH			MEG / CR	48-A3				
ALTEA XL	2006	2008	HURSA2					MEG / CR	48-A3				
ALTEA XL	2006	2008	HURSA8					MEG / CR	48-A3				
ALTEA XL	2008							MEG / CR	48-A3				
EXEO	2008							MEG / CR	48-A3				
FREETRACK	2008							MEG / CR	48-A3				
IBIZA	2008							MEG / CR	48-A3				
LEON	2005	2008	HU66T23	HU66TE	HU66FH			MEG / CR	48-A3				
LEON	2005	2008	HURSA2					MEG / CR	48-A3				
LEON	2005	2008	HURSA8					MEG / CR	48-A3				
LEON	2008							MEG / CR	48-A3				
MII	2012							MEG / CR	48-A3				
TOLEDO	2005	2008	HU66T23	HU66TE	HU66FH			MEG / CR	48-A3				
TOLEDO	2005	2008	HURSA2					MEG / CR	48-A3				
TOLEDO	2005	2008	HURSA8					MEG / CR	48-A3				
SKODA®													
CITIGO	2012							MEG / CR	48-A4				
FABIA	2007	2014	HU66T26	HU66TE	HU66FH			MEG / CR	48-A4				
OCTAVIA	2004	2006	HURSA2					MEG / CR	48-A4				
OCTAVIA	2004	2006	HURSA8					MEG / CR	48-A4				
OCTAVIA	2004	2012	HU66T26	HU66TE	HU66FH			MEG / CR	48-A4				



Car Keys Guide / Guida Chiavi Auto / Marktführer für Autoschlüssel / Guide Clés pour Voitures
 Guía Llaves para Coches / Guia Chaves para Carros

New Updates

1	2	2a	3	3a	3b	E1+E2		6	42+71	72	43 44a	12	15
						GTI COMPATIBLE							
CAR MAKE MODEL	FROM	TO	SILCA REF.	SILCA REF.	SILCA REF.	COPY	GEN.	TRANSP. TYPE	FAST COPY PLUS RW4 PLUS FAST COPY / RW4	FAST COPY PLUS RW4 PLUS	FAST COPY RW4	STP	
													

For more info on the uses of car keys, refer to the Silca Electronic Key Catalogue:



SKODA®

ROOMSTER	2006	2008	HURSA2					MEG / CR	48-A4				
ROOMSTER	2006	2008	HURSA8					MEG / CR	48-A4				
ROOMSTER	2006		HU66T26	HU66TE	HU66FH			MEG / CR	48-A4				
ROOMSTER SCOUT	2007	2008	HU66T26	HU66TE	HU66FH			MEG / CR	48-A4				
ROOMSTER SCOUT	2007	2008	HURSA2					MEG / CR	48-A4				
ROOMSTER SCOUT	2007	2008	HURSA8					MEG / CR	48-A4				
ROOMSTER SCOUT	2008							MEG / CR	48-A4				
SUPERB	2008							MEG / CR	48-A4				
YETI	2009							MEG / CR	48-A4				

VOLKSWAGEN®

AMAROK	2011							MEG / CR	48-A1				
BEETLE	2003	2013	HU66T24	HU66TE	HU66FH			MEG / CR	48-A1				
CADDY	2004		HU66T24	HU66TE	HU66FH			MEG / CR	48-A1				
CADDY	2009							MEG / CR	48-A1				
CARAVELLE	2003	2009	HU66T24	HU66TE	HU66FH			MEG / CR	48-A1				
CRAFTER	2006							MEG / CR	48-A1				
CROSS GOLF	2006	2007	HU66T24	HU66TE	HU66FH			MEG / CR	48-A1				
CROSS GOLF	2006	2007	HURSA2					MEG / CR	48-A1				
CROSS GOLF	2006	2007	HURSA8					MEG / CR	48-A1				
CROSS GOLF	2008							MEG / CR	48-A1				
EOS	2006	2007	HURSA2					MEG / CR	48-A1				
EOS	2006	2007	HURSA8					MEG / CR	48-A1				
EOS	2006		HU66T24	HU66TE	HU66FH			MEG / CR	48-A1				
EOS	2008							MEG / CR	48-A1				
GOLF	2004	2008	HURSA2					MEG / CR	48-A1				

VOLKSWAGEN®

GOLF	2004	2008	HURSA8					MEG / CR	48-A1				
GOLF	2004	2012	HU66T24	HU66TE	HU66FH			MEG / CR	48-A1				
GOLF	2008	2012						MEG / CR	48-A1				
GOLF CABRIO	2004		HU66T24	HU66TE	HU66FH			MEG / CR	48-A1				
INDIVIDUAL	2004	2008	HU66T24	HU66TE	HU66FH			MEG / CR	48-A1				
INDIVIDUAL	2004	2008	HURSA2					MEG / CR	48-A1				
INDIVIDUAL	2004	2008	HURSA8					MEG / CR	48-A1				
JETTA	2004	2007	HURSA2					MEG / CR	48-A1				

**Car Keys Guide / Guida Chiavi Auto / Marktführer für Autoschlüssel / Guide Clés pour Voitures
Guía Llaves para Coches / Guia Chaves para Carros**

New Updates

1	2	2a	3	3a	3b	E1+E2		6	42+71	72	43 44a	12	15
						GTI COMPATIBLE							
CAR MAKE MODEL	FROM	TO	SILCA REF.	SILCA REF.	SILCA REF.	COPY	GEN.	TRANSP. TYPE	FAST COPY PLUS RW4 PLUS FAST COPY / RW4	FAST COPY PLUS RW4 PLUS	FAST COPY RW4	STP	

For more info on the uses of car keys, refer to the Silca Electronic Key Catalogue:



VOLKSWAGEN®

JETTA	2004	2007	HURSA8					MEG / CR	48-A1				
JETTA	2004	2012	HU66T24	HU66TE	HU66FH			MEG / CR	48-A1				
KOMBI	2003	2009	HU66T24	HU66TE	HU66FH			MEG / CR	48-A1				
MAGOTAN	2007							MEG / CR	48-A1				
MULTIVAN	2003	2009	HU66T24	HU66TE	HU66FH			MEG / CR	48-A1				
PASSAT	2004	2005	HU66T24	HU66TE	HU66FH			MEG / CR	48-A1				
PASSAT	2004	2005	HURSA2					MEG / CR	48-A1				
PASSAT	2004	2005	HURSA8					MEG / CR	48-A1				
PASSAT	2006							MEG / CR	48-A1				
POLO	2005	2009	HU66T24	HU66TE	HU66FH			MEG / CR	48-A1				
POLO	2010							MEG / CR	48-A1				
SCIROCCO	2008							MEG / CR	48-A1				
SHARAN	2010							MEG / CR	48-A1				
TIGUAN	2007							MEG / CR	48-A1				
TOURAN	2003	2007	HURSA2					MEG / CR	48-A1				
TOURAN	2003	2007	HURSA8					MEG / CR	48-A1				
TOURAN	2003	2012	HU66T24	HU66TE	HU66FH			MEG / CR	48-A1				
TOURAN	2008	2012						MEG / CR	48-A1				
TRANSPORTER	2004	2008	HU66T24	HU66TE	HU66FH			MEG / CR	48-A1				
TRANSPORTER	2009							MEG / CR	48-A1				
UP!	2012							MEG / CR	48-A1				

VOLKSWAGEN® SUD AMERICA

BEETLE	2008							MEG / CR	48-A1				
FOX	2009		HU66T24	HU66TE	HU66FH			MEG / CR	48-A1				
GOL	2009		HU66T24	HU66TE	HU66FH			MEG / CR	48-A1				
VOYAGE	2009		HU66T24	HU66TE	HU66FH			MEG / CR	48-A1				



See also the NEW "Vehicle Guide Legend"
Vedi anche la NUOVA "Legenda Guida Veicoli"
Siehe auch die NEUE "Fahrzeugschlüssel Erläuterung"
Voir aussi la NOUVELLE "Légende Guide Véhicules"
Véase también la NUEVA "Leyenda Guía para Vehículos"
Veja também a NOVA "Legenda Guia para Veículos"

* The uses of the keys are purely indicative and may be subject to updates and revisions. / Gli utilizzi delle chiavi sono da considerarsi puramente indicativi e possono essere oggetto di aggiornamenti e revisioni. / Die Abbildung und technischen Daten der Schlüssel sind nicht bindend. Silca behält sich Änderungen am Produkt, die zur Verbesserung beitragen, vor. / Les usages des clés sont purement indicatifs; ils peuvent être mis à jour et revus. / Los usos de las llaves deben considerarse puramente indicativos y pueden ser objeto de actualizaciones y revisiones. / As utilizações das chaves devem ser consideradas puramente indicativas e podem ser objecto de actualizações e revisões.

© Registered Trademarks. / © Marchi Registrati. / © Eingetragene Marken. / © Marques Déposées. / © Marcas Registradas. / © Marcas Registradas.

Token Solution

Silca introduces a brand new way of working that is smart, flexible, and cost-effective. Discover the many advantages of opting for a “pay per use” solution!



TOKEN SOLUTION

The flexible option for a successful key cutting business

A number of electronic key cutting machines and devices from Silca are now available with the “pay as you go” formula, i.e. can be used with deductible digital tokens.

Discover the many advantages of this solution:

- // Significant reduction of the start-up cost.
- // Payment for the actual use of the machine or device.
- // Custom-tailored and flexible investment.
- // Free software updates.
- // Exclusive free trial period.
- // Cost-effective planning of your token consumption.
- // Extra Token advanced by Silca when you run out of tokens.
- // Free to opt out of the Token Solution and move to full mode at any time.

SOLUZIONE TOKEN

La soluzione flessibile per un servizio chiavi di successo

Una serie di macchine duplicatrici e dispositivi elettronici Silca è ora disponibile con formula “pay per use”, grazie all'utilizzo di gettoni digitali, i cosiddetti “token”.

Scopri i numerosi vantaggi di questa soluzione:

- // Riduzione significativa della spesa iniziale.
- // Pagamento solo per l'effettivo utilizzo della macchina o del dispositivo.
- // Investimento personalizzato e flessibile.
- // Aggiornamenti software gratuiti.
- // Prova gratuita esclusiva.
- // Pianificazione efficiente del tuo consumo di token.
- // Extra Token anticipato da Silca quando hai esaurito i token.
- // Libero di uscire dalla Soluzione Token e passare alla modalità “full” in qualsiasi momento.

TOKEN-LÖSUNG

Die flexible Lösung für ein erfolgreiches Schlüsselkopiergeschäft

Eine Reihe von Silca Schlüsselkopiermaschinen und elektronischen Geräten ist jetzt auch auf „Pay per use“-Basis erhältlich, d.h. sie funktionieren mit elektronischen Wertmarken, die so genannten „Token“.

Entdecken Sie die zahlreichen Vorteile dieses Systems:

- // Anschaffungskosten werden deutlich reduziert.
- // Sie zahlen nur für die tatsächliche Nutzung.
- // Maßgeschneiderte und flexible Investitionen.
- // Kostenlose Software-Aktualisierungen.
- // Exklusive Testversion.
- // Kosteneffiziente Planung Ihres Token Verbrauchs.
- // Extra Token für den Fall, dass Sie alle Token aufgebraucht haben.
- // Jederzeit frei auf Vollmodus zu wechseln und die Token-Lösung zu verlassen.

> More info on all Silca websites



■ ■ TOKEN SOLUTION

L'option flexible pour la réussite de votre activité

Une série de machines à tailler les clés et dispositifs électroniques Silca est aujourd'hui disponible avec paiement à l'utilisation, grâce à l'usage de jetons numériques, appelés également "token".

Découvrez les nombreux avantages de cette solution:

- // Réduction conséquente des coûts de démarrage.
- // Paiement à l'utilisation.
- // Investissement sur mesure et flexible.
- // Mises à jour du logiciel gratuites.
- // Essai gratuit en exclusivité.
- // Planification économique de votre consommation de jetons.
- // Extra Token pour les cas dont vous avez utilisé tous vos jetons.
- // Libre à tout moment de passer en mode illimité.

■ ■ SOLUCIÓN TOKEN

La opción más flexible para garantizar el éxito de su servicio llaves

Unas máquinas duplicadoras y unos dispositivos electrónicos Silca están ahora disponibles con una fórmula de "pago por consumo", utilizando fichas digitales ("token").

Descubra las ventajas de esta solución:

- // Reducción significativa del coste de puesta en marcha.
- // Se paga sólo el uso real del dispositivo o de la máquina.
- // Inversión personalizada y flexible.
- // Actualización software sin cargo.
- // Prueba gratuita exclusiva.
- // Planificación rentable del consumo de tokens.
- // Extra Token (Ficha Extra) en el caso de agotar todos sus tokens.
- // Disponibilidad de cambiar a modo completo en cualquier momento.

■ ■ SOLUÇÃO TOKEN

A solução flexível para um serviço de chaves de sucesso

Uma série de máquinas duplicadoras e dispositivos eletrônicos Silca está agora disponível com a fórmula "pay per use", graças à utilização de fichas digitais, os chamados "token".

Conheça as numerosas vantagens desta solução:

- // Redução significativa do custo inicial.
- // Pagar somente o que for efetivamente utilizado.
- // Investimento personalizado e flexível.
- // Atualizações gratuitas do software.
- // Prova gratuita exclusiva.
- // Planejamento eficiente do seu consumo de token.
- // Extra Token no caso em que o cliente utilize todos os token.
- // Livre de passar para a modalidade "full" em qualquer momento.

TOKEN TYPES / TIPI DI TOKEN / ARTEN VON TOKEN / TYPES DE JETONS / TIPOS DE TOKENS / TIPOS DE TOKEN



Token Packs: sets of a fixed number of tokens, deducted once a key has been copied in different amounts depending on the type of key.

Token Pack: pacchetti consistenti in un determinato numero di token, scalati ogni volta che viene duplicata una chiave, in quantità diversa in base alla tipologia di chiave.

Token Pakete: Pakete aus einer festen Anzahl von Tokens. Für jede Kopie werden Token (abhängig von der Art des Schlüssels) abgezogen.

Token Packs: jeux de jetons d'un nombre prédéterminé, avec déduction à chaque reproduction de clé selon le type de clé reproduite.

Paquetes de Tokens: series de un número determinado de tokens, que se restan cuando se copia una llave, en cantidades que varían según el tipo de llave.

Token Pack: pacotes de um determinado número de token, desfalcados cada vez que for duplicada uma chave, em quantidades diferentes com base no tipo de chave.



Unlimited Token Plan (UTP): subscriptions valid for a set duration of time, starting from 1 month. During the period of validity of the subscription, you will be able to duplicate an unlimited number of keys.

Token a Tempo o Unlimited Token Plan (UTP): abbonamenti di durata variabile, a partire da un mese. Durante il periodo di validità dell'abbonamento, potrai duplicare un numero illimitato di chiavi.

Unbegrenzte Token Pakete / Unlimited Token Plan (UTP): Abonnements gelten für einen festgelegten Zeitraum, beginnend ab einem Monat. Während der Laufzeit des Abonnements können Sie unbegrenzt Schlüssel kopieren.

Unlimited Token Plan (UTP): abonnements à durée déterminée, à partir de 1 mois. Pendant la période de validité de l'abonnement, vous pouvez reproduire un nombre illimité de clés.

Plan Ilimitado de Tokens / Unlimited Token Plan (UTP): suscripciones válidas por un tiempo determinado, empezando desde 1 mes. Durante el período de validez de la suscripción, usted podrá duplicar un número ilimitado de llaves.

Token a Tempo ou Unlimited Token Plan (UTP): assinaturas de duração variável, começando de um mês. Durante o período de validade da assinatura, poderá duplicar um número ilimitado de chaves.



> More info on all Silca websites



Futura Automotive Token

🇬🇧 FUTURA AUTOMOTIVE TOKEN

Futura Automotive Token is the ground-breaking electronic key cutting machine from Silca for flat and laser vehicle keys with a “pay as you go” formula.

With Futura Automotive Token you will benefit from a reduced purchase price and a flexible management of the investment over time. In fact, it applies digital tokens you will be able to buy according to your needs and to your actual use of the machine.

🇫🇷 FUTURA AUTOMOTIVE TOKEN

La Futura Automotive Token est la nouvelle machine révolutionnaire à tailler les clés de Silca, pour les clés automobiles plates et à vagues (laser), avec paiement à l'utilisation.

Avec la Futura Automotive Token, vous bénéficiez d'un prix d'achat réduit et d'une gestion flexible de l'investissement au fil du temps. Il s'agit en fait de jetons numériques que vous pouvez acheter en fonction de vos besoins et de votre utilisation réelle de la machine.

🇮🇹 FUTURA AUTOMOTIVE TOKEN

Futura Automotive Token è l'innovativa duplicatrice elettronica Silca per chiavi veicolo a cifratura piana e laser, utilizzabile con un sistema “pay per use”.

Futura Automotive Token garantisce una ridotta spesa al momento dell'acquisto e una gestione flessibile dell'investimento nel tempo, grazie all'applicazione di gettoni digitali, i cosiddetti “token”, che potrai acquistare in base alle tue esigenze e al tuo effettivo utilizzo della macchina.

🇪🇸 FUTURA AUTOMOTIVE TOKEN

Futura Automotive Token es la innovadora duplicadora electrónica de Silca para llaves de vehículos planas y de regata con una formula de “pago por consumo”.

Con Futura Automotive Token se beneficiará de un precio reducido de compra y una gestión flexible de inversión a lo largo del tiempo. De hecho, funciona mediante tokens (fichas digitales) que podrá adquirir de acuerdo con sus necesidades y el uso real de la máquina.

TYPES OF DUPLICABLE KEYS

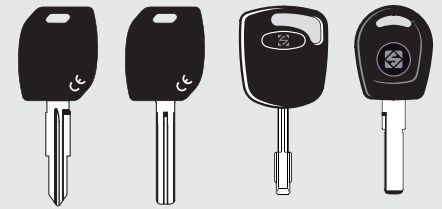

STANDARD EQUIPMENT

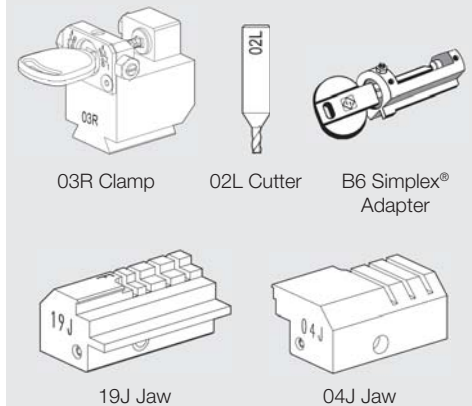

🇩🇪 FUTURA AUTOMOTIVE TOKEN

Futura Automotive Token ist die bahnbrechende elektronische Schlüsselfräsmaschine von Silca zum Schneiden von Fahrzeug Flach- und Bahnschlüsseln mit einer „Pay per use“ Formel.

Bei der Futura Automotive Token profitieren Sie von einem reduzierten Kaufpreis und mit den digitalen Token (Guthaben) sind Sie in der Lage, je nach Ihren Bedürfnissen und Ihrem tatsächlichen Gebrauch der Maschine ein entsprechenden Guthaben zu kaufen.

🇵🇹 FUTURA AUTOMOTIVE TOKEN

Futura Automotive Token é a duplicadora eletrônica inovadora da Silca para chaves de veículo de corte plano e laser, utilizável com um sistema “pay per use”.

Futura Automotive Token garante uma despesa reduzida na altura da compra e uma gestão flexível do investimento no tempo. De facto, a máquina duplicadora utiliza fichas digitais, os chamados “token”, que poderá comprar com base nas suas exigências e na utilização efectiva da máquina.

> [More info on all Silca websites](#)



Silca ID48

The first complete cloning solution is coming soon

SILCA ID48

Silca is pleased to invite you to be part of the #1 full ID48 cloning solution. Join the pre-booking of Silca ID48, the first professional and up to date concept for automotive keys cloning.

ID48 is based on an add-on hardware compatible with Silca cloning devices and applies a cloud-updating software. Silca ID48 covers over 200 vehicle models of the major automotive groups.

Contact your local distributor or sales rep for further info.

SILCA ID48

Silca est heureux de présenter la première solution complète de reproduction des clés transpondeur ID48. Participez dès maintenant à la campagne de pré-réservation.

Grâce à l'ajout d'un boîtier complémentaire connecté à Internet, la solution Silca ID48 est compatible avec les dispositifs actuels de clonage Silca. Silca ID48 couvre plus de 200 modèles de véhicules parmi les grands groupes automobiles.

Contactez votre distributeur ou votre représentant de vente local pour plus d'informations.

SILCA ID48

Silca ti invita a scoprire la prima soluzione completa dedicata alla clonazione di ID48. Prenotala ora in anteprima a condizioni agevolate.

ID48 è una soluzione web all'avanguardia che utilizza un componente hardware aggiuntivo compatibile con i dispositivi di clonazione Silca. Silca ID48 garantisce la clonazione di oltre 200 modelli veicolo dei maggiori gruppi automobilistici al mondo.

Contatta il tuo distributore o il tuo rappresentante di fiducia per maggiori informazioni.

SILCA ID48

Silca se complace en invitarle a participar en la solución de clonación nº 1 para el ID48 completo. Únete ahora la campaña de pre-reserva.

ID48 es basado en un hardware adaptable a los actuales dispositivos de clonación Silca y en un software actualizable en la nube. Silca ID48 cubre más de 200 modelos de vehículos de los principales grupos de automoción en el mundo.

Contacte con su distribuidor o agente de ventas más cercano para más información.

SILCA ID48

Silca lädt Sie ein, Teil der ersten vollständigen ID48 Klon-Lösung für Fahrzeugschlüssel zu sein. Nehmen Sie noch heute die Möglichkeit des Frühbuchens zu Sonderkonditionen wahr.

Die ID48-Lösung, basiert auf einer zusätzlichen Hardware, die mit den bestehenden Kopiergeräten von Silca kompatibel sind, und auf einer Cloud-Softwarelösung, deckt über 200 Fahrzeugmodelle der führenden Automobilhersteller ab.

Kontaktieren Sie Ihren lokalen Vertriebspartner oder Mitarbeiter für weitere Informationen.

SILCA ID48

A Silca convida-o para descobrir a primeira solução completa dedicada à clonagem de ID48. Reserve-a desde já em antea-treia com condições facilitadas.

ID48 é uma solução web de vanguarda que utiliza um componente hardware adicional compatível com os dispositivos de clonagem Silca. Silca ID48 garante a clonagem de mais de 200 modelos de veículo.

Contacte o seu distribuidor de referência ou o seu representante de confiança para ter mais informações.

> More info on all Silca websites



Smart Aerial

For Fiat® and VAG® transponders pre-coding

EASY PRE-CODING PROCEDURE

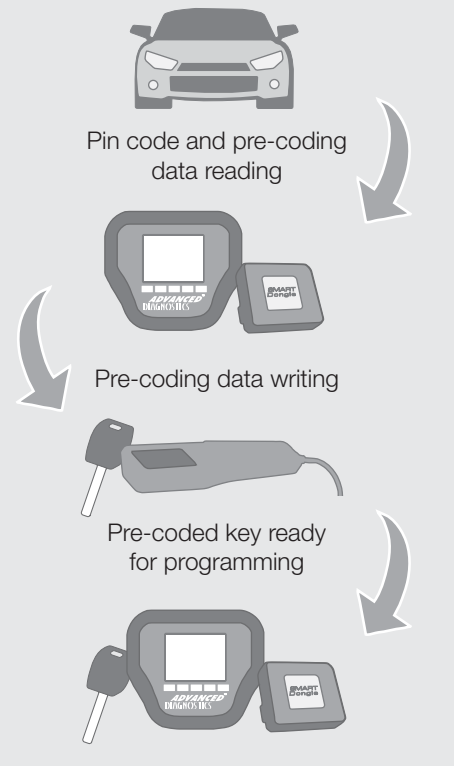

SMART AERIAL

Smart Aerial has been developed to be used with Smart Dogle to write pre-coding data onto ID48 and ID46 transponders found within various keys for Fiat® and VAG® (Audi®, Seat®, Škoda® and Volkswagen®) models.

With Smart Aerial pre-coding data are read in the background and then written automatically onto the blank transponder, avoiding mistakes linked to the manual input of data.

SMART AERIAL

Smart Aerial, utilisé avec Smart Dogle, a été développé pour permettre aux professionnels de la reproduction de clés de pré-coder les transpondeurs ID48 et ID46 de nombreuses clés de véhicules pour Fiat® et VAG® (Audi®, Seat®, Škoda® et Volkswagen®).

Avec Smart Aerial les données de pré-codage sont lues en background et écrites automatiquement sur le transpondeur vierge pour éviter les erreurs liées à l'encodage manuel des données.

SMART AERIAL

Smart Aerial, utilizzato congiuntamente a Smart Dogle, è stato sviluppato per consentire ai duplicatori di pre-codificare transponder ID48 e ID46 presenti in numerose chiavi veicolo Fiat® e VAG® (Audi®, Seat®, Škoda® e Volkswagen®).

Con Smart Aerial i dati di pre-codifica vengono letti in background e scritti automaticamente sul transponder vergine, evitando errori legati all'inserimento manuale di dati.

SMART AERIAL

Smart Aerial fue desarrollado para que los duplicadores, utilizandolo junto a Smart Dogle, puedan precodificar los transponders ID48 e ID46 de numerosas llaves para vehículos Fiat® y VAG® (Audi®, Seat®, Škoda® y Volkswagen®).

Con Smart Aerial los datos de precodificación son leídos en el fondo y escritos automáticamente en el transponder virgen para evitar errores producidos por la introducción manual de datos.

SMART AERIAL

Smart Aerial wurde entwickelt, damit Sie Transponder ID48 und ID46 von zahlreichen Fiat®- und VAG®- (Audi®, Seat®, Škoda®, und Volkswagen®) Fahrzeugschlüsseln vorcodieren können. Smart Aerial wird mit dem Smart Dogle zusammen verwendet.

Die Daten zur Vorcodierung werden im Hintergrund gelesen und automatisch auf den leeren Transponder übertragen, um die mit der manuellen Dateneingabe verbundenen Fehler zu vermeiden.

SMART AERIAL

Smart Aerial foi desenvolvido para permitir aos profissionais da duplicação pré-codificar, utilizado juntamente com Smart Dogle, os transponders ID48 e ID46 de várias chaves para veículos Fiat® e VAG® (Audi®, Seat®, Škoda® e Volkswagen®).

Com Smart Aerial os dados de pré-codificação são lidos em background e escritos automaticamente no transponder virgem para evitar erros ligados à introdução manual de dados.

> [More info on all Silca websites](#)



Silca Key Programs

SKP - Web Update

SKP - WEB Update

A new update of the SILCA KEY PROGRAMS software is available to all WEB subscribers.

Check out the "News" section of Silca Key Programs on www.silca.biz to know more.

SKP - MISE À JOUR WEB

Une nouvelle mise à jour du logiciel SILCA KEY PROGRAMS pour tous les abonnements WEB est disponible.

Consultez la section "Nouveautés" de Silca Key Programs sur notre site www.silca.biz pour en savoir plus.

SKP - AGGIORNAMENTO WEB

È disponibile un nuovo aggiornamento del software SILCA KEY PROGRAMS per tutti gli abbonati WEB.

Consulta la sezione "Novità" di Silca Key Programs sul sito www.silca.biz per saperne di più.

SKP - ACTUALIZACIÓN WEB

Una nueva actualización del software SILCA KEY PROGRAMS para todos los abonados WEB está disponible.

Visite la sección "Novedades" de Silca Key Programs en el sitio www.silca.biz para más informaciones.

SKP - AKTUALISIERUNG WEB

Für alle WEB Abonnenten ist eine neue Aktualisierung von der Software SILCA KEY PROGRAMS verfügbar.

Sehen Sie den Abschnitt "Neuheiten" von Silca Key Programs auf www.silca.biz, um weitere Informationen zu finden.

SKP - ATUALIZAÇÃO WEB

Nova atualização do software SILCA KEY PROGRAMS para todos o assinantes WEB está disponível.

Consulte a seção "Novidades" de Silca Key Programs no site www.silca.biz para saber mais.

SILCA TRIAX PROGRAM - STAND ALONE MODE

SKP Vers. 20.7.5.xx

Triax e-code / Triax 2



IMPORTANT NOTE

The key cutting machine internal memory is full.
All new systems will be available only in the Silca Key Program and not in STAND ALONE mode.

> More info on all Silca websites



Key Cutting Machines Catalogues

KEY MACHINES CATALOGUES

Fully updated! Ask for your copy of these new catalogues or download them from all Silca websites.

Electronic Key Cutting Machines: **code P0BV-4**

Mechanical Key Cutting Machines: **code P0BP-4**

CATALOGHI DUPLICATRICI

Completamente aggiornati! Richiedi la copia di questi nuovi cataloghi oppure scaricali dai siti Silca.

Duplicatrici Elettroniche: **codice P0BW-4**

Duplicatrici Meccaniche: **codice P0BQ-4**

SCHLÜSSELMASCHINENKATALOGE

Vollständig aktualisiert! Verlangen Sie sofort diese neue Kataloge oder laden Sie sie von allen Silca Webseiten herunter.

Elektronische Schlüsselkopiermaschinen: **Code P0BS-4**

Mechanische Schlüsselkopiermaschinen: **Code P0BL-4**

CATALOGUES MACHINES

Complètement à jour! Demandez votre copie de ces nouveaux catalogues ou téléchargez les sur tous les sites web Silca.

Machines à tailler les clés Electroniques: **code P0BU-4**

Machines à tailler les clés Mecaniques: **code P0BN-4**

CATÁLOGOS DUPLICADORAS

¡Completamente actualizados! Pida su copia de estos nuevos catálogos o descargalos de todos los sitios web de Silca.

Duplicadoras Electrónicas: **código P0BT-4**

Duplicadoras Mecánicas: **código P0BM-4**

CATÁLOGOS DUPLICADORAS

Completamente atualizados! Peça sua cópia desses novos catálogos ou baixá-los de todos os sites Silca.

Duplicadoras Eletrônicas: **código P0BX-4**

Duplicadoras Mecânicas: **código P0BR-4**



> More info on all Silca websites



Silca @ Sicurezza 2015

The leading trade show in Italy for security and fire prevention

Milan, 3-5 November 2015
 Silca stand included a selection of the best electronic and mechanical key cutting machines, Air4 residential remotes, cloning and programming devices and the worldwide premiere of Silca ID48



Particular attention was paid to the range of electronic machines



Visitors were able to try Futura and all the key machines exhibited



Attendees showed great interest in the revolutionary Silca ID48



Air4 remotes earned the praise of many locksmiths



The first customer who booked a Silca ID48 solution

Save the date



iFerr Day 2015 - 4th National Hardware Wholesale Congress / 4^o Congresso Nazionale Grossisti Ferramenta
 in Milan, ITALY - Palazzo del Ghiaccio, Stand N61

> More info on www.iferronline.com/it/iferrday2015/congresso.asp



SILCA NEWS 12/15

ALL THE NEW KEYS, AUTOMOTIVE SOLUTIONS, KEY CUTTING MACHINES, SOFTWARE UPDATES AND MUCH MORE

Contents

<u>New Keys</u>	<u>1</u>
<u>Silca ID48 Solution</u>	<u>2</u>
<u>Vehicle Key Finder Pro 3.0</u>	<u>3, 4</u>
<u>Silca Key Programs Update</u>	<u>5, 6, 7, 8</u>
<u>Futura Update</u>	<u>9</u>
<u>Smart Aerial Compatible Software</u>	<u>10</u>
<u>Software AD for Fiat SAM</u>	<u>11, 12, 13</u>
<u>Software AD for Nissan and Ford</u>	<u>14, 15</u>

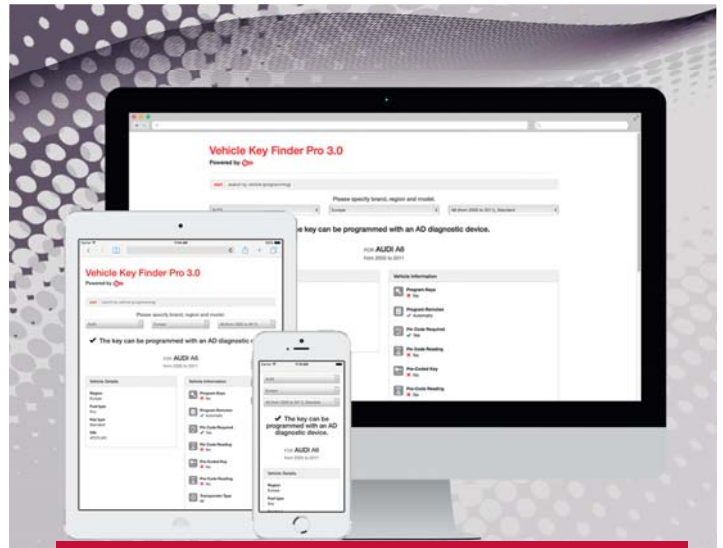



New Keys / Chiavi Nuove / Neue Schlüssel / Nouvelles Clés / Llaves Nuevas / Chaves Nuevas

FOR: PER:	FAB	EURO LOCKS	FOR / PER
	<p>04</p> <p>11</p> <p>Available in stock</p> <p>FB83R 82KR</p>	<p>06</p> <p>P487</p> <p>5</p> <p>Available in stock</p> <p>EU21P</p> <p>HOBBY</p>	FAB (CZ) EURO LOCKS (SE) HOBBY 01 COMMERCIAL GROUP GRUPPO COMMERCIALE PREISEGRUPPE GROUPE COMMERCIAL GRUPO COMMERCIAL GRUPO COMERCIAL www.silca.biz

SILCA EMPTY SHELLS - NEW REFERENCES

Silca Empty Shells: **1 new key reference** to widen the existing range.

Silca Empty Shells: **1 nuova referenza** chiavi che implementa la gamma già esistente.

Silca Empty Shells: **1 Schlüssel Referenz** die das bestehende Angebot implementieren.

Silca Empty Shells: **1 nouvelle référence** clés qui complètent la gamme existante.

Silca Empty Shells: **1 nueva referencia** llaves que completan la gama existente.

Silca Empty Shells: **1 nova referência** chaves que implementam a gama existente.

Brand	References/Image	Specifications	Vehicle Models*				
			MODELS	YEAR		TRANSPONDER TYPE	TRP ID
IVECO®	<p>GT10RS1</p>	1 Button					
			EUROSTAR	1998	2002	PH/CR2	46
			NEW DAILY	1998		PH/CR2	46
			S-2000	1998		PH/CR2	46
			35C11	2000		PH/CR2	46

* The uses of the keys are purely indicative and may be subject to updates and revisions. / Gli utilizzi delle chiavi sono da considerarsi puramente indicativi e possono essere oggetto di aggiornamenti e revisioni. / Die Abbildung und technischen Daten der Schlüssel sind nicht bindend. Silca behält sich Änderungen am Produkt, die zur Verbesserung beitragen, vor. / Les usages des clés sont purement indicatifs; ils peuvent être mis à jour et revus. / Los usos de las llaves deben considerarse puramente indicativos y pueden ser objeto de actualizaciones y revisiones. / As utilizações das chaves devem ser consideradas puramente indicativas e podem ser objecto de actualizações e revisões.

® Registered Trademarks. / ® Marchi Registrati. / ® Eingetragene Marken. / ® Marques Déposées. / ® Marcas Registradas. / ® Marcas Registradas.



NEW!

SILCA ID48 **THE COMPLETE CLONING SOLUTION**



For more info visit the
Automotive Tecnology Section on all Silca websites



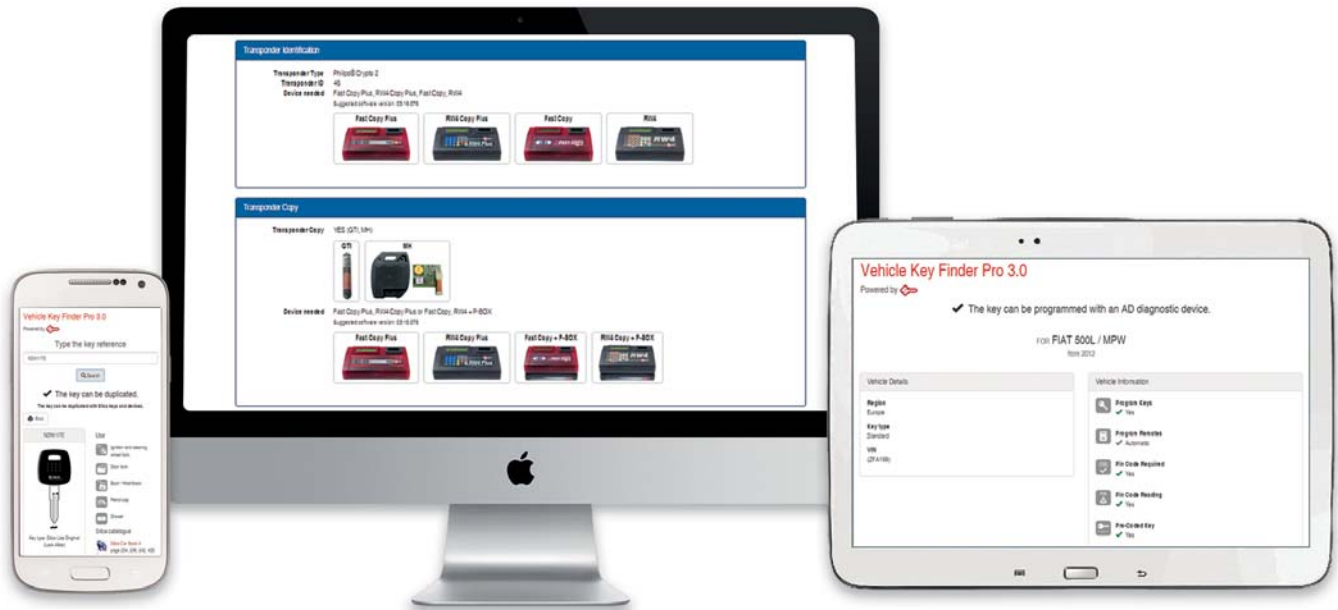

The new **Vehicle Key Finder Pro 3.0** is available for Computer, Tablet and Mobile: ekc.silca.biz/vkf

🇬🇧 VEHICLE KEY FINDER PRO 3.0

Vehicle Key Finder Pro 3.0 is the perfect tool for finding information on a vehicle key you need to duplicate, clone and/or program.

- // It is optimized for PC, tablet and smartphone, and is integrated in MySilca app.
- // It is available in 7 languages: English, Italian, German, French, Spanish, Portuguese, and Dutch.
- // It allows you to search by vehicle make, model and year (both for cloning and programming) and by Silca key reference.
- // The 3 search functions provide relevant information for cutting and programming a vehicle key, cloning its transponder, or copying a vehicle remote. Information provided include:
 - the Silca key reference to use,
 - the type of transponder required,
 - the cloning device needed,
 - the data cards, series, clamps, and accessories necessary to cut the key with Silca key machines,
 - the software, dongles, and cables required.

🇮🇹 VEHICLE KEY FINDER PRO 3.0

Vehicle Key Finder Pro 3.0 è lo strumento ideale per reperire le informazioni necessarie a duplicare, clonare e/o programmare una chiave veicolo.

- // È ottimizzato per PC, tablet e smartphone, ed è integrato a MySilca app.
- // È disponibile in 7 lingue: italiano, inglese, tedesco, francese, spagnolo, portoghese e olandese.
- // Ti consente di effettuare diversi tipi di ricerca: per marca, modello e anno del veicolo (sia per la clonazione che per la programmazione) e per referenza Silca.
- // Le 3 funzioni di ricerca forniscono le informazioni più importanti per cifrare e programmare una chiave veicolo, clonarne il transponder, o copiare un radiocomando veicolo. Fra le altre, VKF Pro 3.0 fornisce le seguenti informazioni:
 - la referenza Silca da utilizzare,
 - il tipo di transponder richiesto,
 - il dispositivo di clonazione più indicato,
 - le schede software, le serie, i morsetti e gli eventuali accessori necessari a cifrare la chiave con le duplicatrici Silca,
 - i software, i dongle e i cavi richiesti.

🇩🇪 VEHICLE KEY FINDER PRO 3.0

Vehicle Key Finder Pro 3.0 ist das ideale Instrument, um die zum Fräsen, Kopieren und/ oder Programmieren von Autoschlüsseln erforderlichen Informationen zu finden.

- // Optimiert für PC, Tablet und Smartphone und in MySilca App integriert.
- // In 7 Sprachen erhältlich: Deutsch, Englisch, Italienisch, Französisch, Spanisch, Portugiesisch und Niederländisch.
- // Verschiedene Suchmodalitäten: nach Marke, Modell und Baujahr (sowohl für das Kopieren als auch für das Programmieren) und nach Silca-Referenzen.
- // Die 3 Suchfunktionen liefern die wichtigsten Daten für das Fräsen und Programmieren eines Autoschlüssels, für das Kopieren eines Transponders oder einer Funkfernbedienung. VKF Pro 3.0 stellt u.a. die folgenden Daten bereit:
 - die einzusetzende Silca-Referenz,
 - die erforderliche Transponder-Art,
 - das am besten geeignete Kopiergerät,
 - die erforderlichen Software-Karten, Serien, Backen und Zubehör für das Fräsen von Schlüsseln mit den Maschinen Silca,
 - die erforderlichen Softwares, Dongles und Kabel.

> More info on all Silca websites

VEHICLE KEY FINDER PRO 3.0

Vehicle Key Finder Pro 3.0 est l'instrument idéal pour trouver les informations nécessaires pour reproduire, cloner et/ou programmer une clé véhicule.

- // Optimisé pour PC, tablette et smartphone, il est intégré à MySilca app.
- // Disponible en 7 langues: français, anglais, italien, allemand, espagnol, portugais et néerlandais.
- // Permet de faire différents types de recherche: par marque, modèle et année du véhicule (tant pour la reproduction que pour la programmation) et par références Silca.
- // Les 3 fonctions de recherche donnent les informations les plus importantes pour tailler et programmer une clé véhicule, en cloner le transpondeur, ou copier une télécommande véhicule. VKF Pro 3.0 fournit, entre autres, les informations suivantes:
 - la référence Silca à utiliser,
 - le type de transpondeur demandé,
 - le dispositif de reproduction le plus indiqué,
 - les onglets software, les séries, les étaux et les accessoires nécessaires pour tailler la clé avec les machines Silca,
 - les logiciels, les dongles et les câbles requis.

VEHICLE KEY FINDER PRO 3.0

Vehicle Key Finder Pro 3.0 es la herramienta ideal para obtener la información necesaria para duplicar, clonar y/o programar una llave de vehículo.

- // Se ha optimizado para PCs, tabletas y smartphone, y se ha integrado en MySilca app.
- // Existe en 7 idiomas: español, inglés, italiano, alemán, francés, portugués y holandés.
- // Te permite llevar a cabo varios tipos de búsqueda: por marca, modelo y año del vehículo (para la clonación y para la programación) y por referencia Silca.
- // Las 3 funciones de búsqueda proporcionan la información más importante para cortar y programar una llave de vehículo, clonar su transponder o copiar un radiomando de vehículo. VKF Pro 3.0 proporciona la siguiente información entre otras:
 - la referencia Silca usada,
 - el tipo de transponder demandado,
 - el dispositivo de clonación más indicado,
 - las tarjetas software, la serie, las mordazas y los accesorios necesarios para cortar la llave con las duplicadoras Silca,
 - los software, los dongle y los cables demandados.

VEHICLE KEY FINDER PRO 3.0

Vehicle Key Finder Pro 3.0 é o instrumento ideal para encontrar as informações necessárias para duplicar, clonar e/ou programar uma chave para veículo.

- // É otimizado para PC, tablet e smartphone, e é integrado a MySilca app.
- // Está disponível em 7 idiomas: português, inglês, italiano, alemão, francês, espanhol e holandês.
- // Permite efectuar vários tipos de pesquisa: por marca, modelo e ano do veículo (quer para a clonagem quer para a programação) e por referência Silca.
- // As 3 funções de pesquisa fornecem as informações mais importantes para cortar e programar uma chave para veículo, clonar o transponder, ou copiar um radiocomando para veículo. Entre as outras, VKF 3.0 fornece as informações seguintes:
 - a referência Silca a utilizar,
 - o tipo de transponder solicitado,
 - o dispositivo de clonagem mais indicado,
 - as fichas software, as séries, os mordentes e os acessórios necessários para cortar a chave com as duplicadoras Silca,
 - os softwares, os dongle e os cabos exigidos.

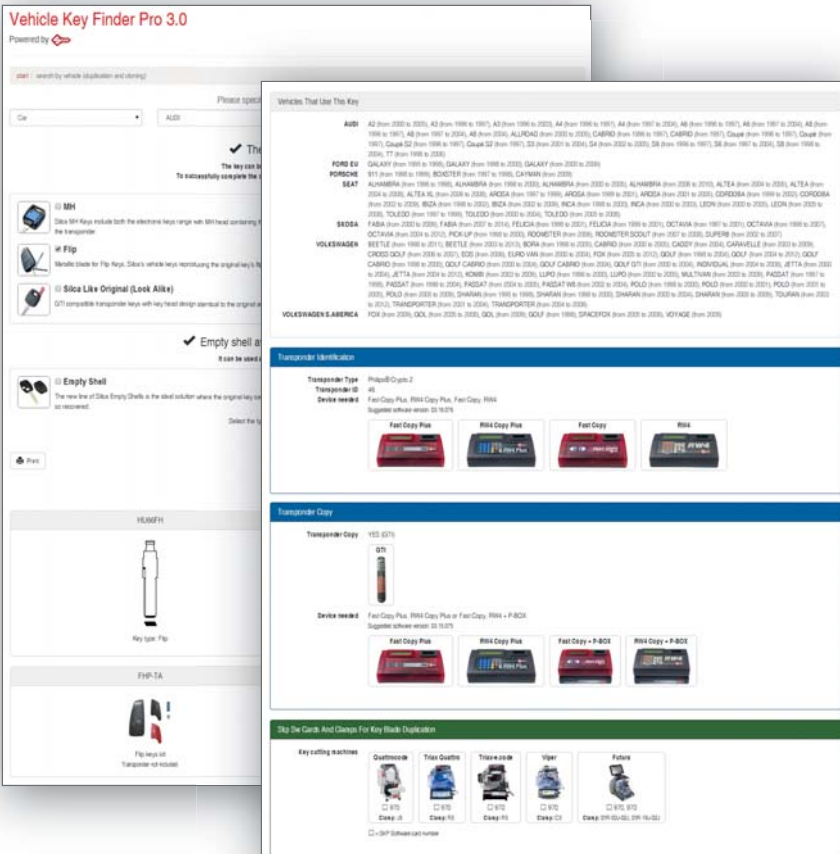

SYSTEM REQUIREMENTS: Vehicle Key Finder Pro 3.0 needs a modern browser, javascript (active by default on all browsers) and cookies to function properly. Cookies don't track personal data but keep some basic information like the language of the app. Supported browsers: Internet Explorer 9 or better, Chrome 20 or better, Firefox 8 or better, Safari 6 or better.

REQUISITI DI SISTEMA: Per funzionare correttamente, Vehicle Key Finder Pro 3.0 necessita di un browser moderno, javascript (già attivo di default su tutti i browser), e il permesso di impostare i cookie. I cookie non salvano dati personali ma conservano solo alcune informazioni di base come la lingua dell'applicazione. Browser supportati: Internet Explorer 9 o successivo, Chrome 20 o successivo, Firefox 8 o successivo, Safari 6 o successivo.

SYSTEMANFORDERUNGEN: Zum einwandfreien Funktionieren braucht Vehicle Key Finder Pro 3.0 einen modernen Browser, Javascript (schon in allen Browsern aktiviert) und die Befähigung zur Cookie-Einstellung. Die Cookies speichern keine personenbezogenen Daten, sondern nur einige Grundinformationen, wie die Anwendungssprache. Unterstützte Browser: Internet Explorer 9 oder spätere Version, Chrome 20 oder spätere Version oder, Firefox 8 o spätere Version, Safari 6 oder spätere Version.

CONFIGURATION REQUIRE: Pour marcher correctement, Vehicle Key Finder Pro 3.0 a besoin d'un browser moderne, javascript (déjà en service par défaut sur tous les browsers) et d'un permis d'imposer les cookies. Les cookies ne sauvegardent pas les données personnelles car il ne conservent que certaines informations générales comme la langue de l'application. Browser admis: Internet Explorer 9 ou postérieur, Chrome 20 ou postérieur, Firefox 8 ou postérieur, Safari 6 ou postérieur.

REQUISITOS DE SISTEMA: Vehicle Key Finder Pro 3.0 para funcionar correctamente requiere un navegador moderno, javascript (con activación predefinida en todos los navegadores) y la autorización para configurar las cookies. Las cookies no guardan datos personales, solamente conservan información básica como lo es el idioma de la aplicación. Navegadores soportados: Internet Explorer 9 o sucesivo, Chrome 20 o sucesivo, Firefox 8 o sucesivo y Safari 6 o sucesivo.

REQUISITOS DE SISTEMA: Para funcionar correctamente, Vehicle Key Finder Pro 3.0 necessita de um browser moderno, javascript (já activo por padrão em todos os browsers), e a possibilidade de programar os cookies. Os cookies não guardam dados pessoais, mas só armazenam algumas informações básicas como o idioma da aplicação. Browsers suportados: Internet Explorer 9 ou mais recente, Chrome 20 ou mais recente, Firefox 8 ou mais recente, Safari 6 ou mais recente.

> More info on all Silca websites



Silca Key Programs

Update 3/2015 - SKP Vers. 20.8.x.xx

UPDATE 3/2015

New Silca Key Programs 3/2015 Update for all WEB and DVD subscribers available in the "News" section of Silca Key Programs.

Discover all the updates for Silca Code Program, Silca Triax - Quattrocode Program, Silca Viper Program, and Silca Transponder Program.

MISE A JOUR 3/2015

Nouvelle mise à jour Silca Key Programs 3/2015 pour tous les abonnés WEB et DVD disponible dans la section "Nouveautés" de Silca Key Programs.

Découvrez toutes les mises à jour pour Silca Code Program, Silca Triax - Quattrocode Program, Silca Viper Program et Silca Transponder Program.

AGGIORNAMENTO 3/2015

Nuovo Aggiornamento Silca Key Programs 3/2015 per tutti gli abbonati WEB e DVD consultabile nella sezione "Novità" di Silca Key Programs.

Scopri tutti gli aggiornamenti per Silca Code Program, Silca Triax - Quattrocode Program, Silca Viper Program, e Silca Transponder Program.

ACTUALIZACIÓN 3/2015

Nueva actualización Silca Key Programs 3/2015 para todos los abonados WEB y DVD disponible en la sección "Novedades" de Silca Key Programs.

Descubra todas las actualizaciones para Silca Code Program, Silca Triax - Quattrocode Program, Silca Viper Program y Silca Transponder Program.

AKTUALISIERUNG 3/2015

Neue Aktualisierung Silca Key Programs 3/2015 für alle WEB und DVD Abonnenten ist in der Sektion "Neuheiten" des Silca Key Programs verfügbar.

Entdecken Sie die Aktualisierungen für Silca Code Program, Silca Triax - Quattrocode Program, Silca Viper Program und Silca Transponder Program.

ATUALIZAÇÃO 3/2015

Nova atualização Silca Key Programs 3/2015 para todos o assinantes WEB e DVD disponível na seção "Novidades" de Silca Key Programs.

Descubra todas as atualizações para Silca Code Program, Silca Triax - Quattrocode Program, Silca Viper Program e Silca Transponder Program.

> More info on all Silca websites

SILCA CODE PROGRAM

Data Update with 65 new cutting cards

SKP Vers. 20.8.x.xx



Unocode 199



Unocode 299/399



Unocode 399 Evo

Data update with 65 new cutting cards / Aggiornamento dati con 65 nuove schede / Datenaktualisierung mit 65 neuen Karten / Mise à jour des données avec 65 nouvelles fiches / Actualización datos con 65 fichas nuevas. / Atualização de dados com 65 fichas novas.

New items include / Tra le novità / Unter den Neuheiten / Parmi les nouveautés / Entre las novedades / Entre as novidades:

- | | | |
|--------------------|------------------------------------|----------------|
| - Ankerslot® | - Fastec® | - Oxloc® |
| - Anderson Hickey® | - Haworth® | - Pundra® |
| - Bommer® | - Honda® | - Ronis® |
| - Burg® | - Hyundai® | - Sentry® |
| - Chicago® | - Ifam® (E30-40-50-60 & M30-40-60) | - Squire&Sons® |
| - Craftsman® | - Illinois® | - Subaru® |
| - Eagle® | - Jpm® | - Taylor® |
| - Euro Locks® | - National® | - Tokoz® |
| - F.I.C.® | | - Union® |



Update the software on / Aggiornare il software di / Aktualisierung der Software von / Mettre à jour le logiciel de / Actualizar el software de / Atualizar o software de: UC199/UC299/UC399/UC399 EVO.

ATTENTION: In agreement with Abus® Pfaffenhain, cards 3907, 3910, 3913, 3915, 3916, 3922 used for the Vitess-Zolit lock systems will pass from 5 to 6 pins (cuts). All the Vitess-Zolit series created by the user and all the Vitess-Zolit keys saved in the customer archive must be removed and reinserted.

ATTENZIONE: In accordo con Abus® Pfaffenhain, le schede 3907, 3910, 3913, 3915, 3916, 3922 dei sistemi Vitess-Zolit passano da 5 a 6 intagli. Tutte le serie Vitess-Zolit create dall'utente e le chiavi Vitess-Zolit salvate nello storico cliente devono essere rimosse e inserite nuovamente.

VORSICHT: Im Einvernehmen mit Abus® Pfaffenhain werden die Karten 3907, 3910, 3913, 3915, 3916, 3922 (verwendet für Vitess-Zolit Zylinder) von 5 zu 6 Stifte (Einschnitte) verändert. Alle Seriendateien für die Systeme Vitess-Zolit müssen entfernt und wieder eingesetzt werden.

ATTENTION: En accord avec Abus® Pfaffenhain, les fiches 3907, 3910, 3913, 3916, 3922 des systèmes Vitess-Zolit passent de 5 à 6 entailles. Toutes les séries Vitess-Zolit créées par l'utilisateur et les clés Vitess-Zolit sauvegardées dans l'historique client devront être supprimées et insérées de nouveau.

ATENCIÓN: En acuerdo con Abus® Pfaffenhain, las fichas 3907, 3910, 3913, 3915, 3916, 3922 del sistema Vitess-Zolit pasaran de 5 a 6 cortes. Todas las series creadas por el usuario y las llaves guardadas en el histórico de clientes del sistema Vitess-Zolit deben removerse y ser insertadas nuevamente.

ATENÇÃO: A Abus® Pfaffenhain informa que os cortes das fichas 3907, 3910, 3913, 3915, 3916, 3922 usados nos sistemas de fechaduras Vitess-Zolit, passarão de 5 para 6 pinos. Assim sendo, todas as series Vitess-Zolit criadas pelo utilizador, bem como todas as chaves Vitess-Zolit guardadas no arquivo de cliente, deverão ser removidas e reinseridas.

SILCA TRIAX - QUATTROCODE PROGRAM

Data Update with 40 new series

SKP Vers. 20.8.x.xx



Triax Quattro /
Triax e-code



Quattrocode

Data update with 40 new series / Aggiornamento dati con 40 nuove serie / Daten-Aktualisierung mit 40 neuen Serien / Mise à jour des données avec 40 nouvelles séries / Actualización datos con 40 series nuevas / Atualização de dados com 40 séries novas.

New items include / Tra le novità / Unter den Neuheiten / Parmi les nouveautés / Entre las novedades / Entre as novidades:

- Abus® Bravus 1000 (Tip stop)
- Abus® Bravus 2000 (Tip stop)
- Abus® Bravus 4000 (Tip stop)
- Avocet® Pioneer plus (6P)
- Corbin® TWO (6P)
- DOM® IXSATS (Prof. 167)
- INN® (Pr. 169 - 170 - 171 - 172) (Pre-coded)
- INN® (Prof. 167)
- INN® (Prof. 169)
- INN® (Prof. 170)
- INN® (Prof. 171)
- INN® (Prof. 172)
- Kale® 164 DBNE (5+5)
- Oxloc® O9
- Pacri® (5+5)
- Prefer® S211 (5+5+4)
- Prefer® UL20 (6P)
- Subaru® Emergency Key (2T-4W)
- Winkhaus® ON-tra
- Winkhaus® ON-tra +



Update the software on / Aggiornare il software di / Aktualisierung der Software von / Mettre à jour le logiciel de / Actualizar el software de / Atualizar o software de: TRIAX e-code, TRIAX QUATTRO.

ATTENTION: TRIAX E-CODE and TRIAX 2 machine internal memory is full. All new systems will only be added to SKP and not into the machine.

ATTENZIONE: La memoria interna delle duplicatrici TRIAX E-CODE e TRIAX 2 è completa. I nuovi sistemi serratura saranno inseriti solo nel SKP e non a bordo macchina.

VORSICHT: Bei den Maschinen TRIAX E-CODE und TRIAX 2 ist der interne Speicher voll. Alle neuen Systeme werden nur im SKP hinzugefügt jedoch nicht in der Maschine!

ATTENTION: La mémoire interne de la machine TRIAX E-CODE et TRIAX 2 est pleine. Les nouveaux systèmes seront intégrés seulement dans le SKP et non à l'intérieur de la machine.

ATENCIÓN: La memoria interna de la duplicadora TRIAX E -CODE e TRIAX 2 esta llena. Los nuevos sistemas deben ser insertados solo en el SKP y no a bordo maquina.

ATENÇÃO: A memória interna das máquinas TRIAX E-CODE e TRIAX 2 está cheia. Todos os novos sistemas, serão adicionados ao SKP e não à máquina.

SILCA VIPER PROGRAM

Data Update with 1 new series

SKP Vers. 20.8.x.xx



Viper

Data update with 1 new series / Aggiornamento dati con 1 nuova serie / Daten-Aktualisierung mit 1 neuen Serie / Mise à jour des données avec 1 nouvelle série / Actualización datos con 1 serie nueva / Atualização de dados com 1 série nova.

- Subaru® Emergency Key (2T-4W)



Update the software on / Aggiornare il software di / Aktualisierung der Software von / Mettre à jour le logiciel de / Actualizar el software de / Atualizar o software de: VIPER.

SILCA TRANSPONDER PROGRAM

Data Update with 226 new vehicle applications

SKP Vers. 20.8.x.xx



RW4 Plus / RW4



Fast Copy Plus /
Fast Copy



Update the software on:
 Aggiornare il software di:
 Aktualisierung der Software von:
 Mettre à jour le logiciel de:
 Actualizar el software de:
 Atualizar o software de:
 RW4 PLUS, RW4,
 FAST COPY PLUS, FAST COPY.

 Silca Transponder Program has been updated with 226 new vehicle applications. New software version 03.20.080 for all RW devices.

View the news in the Help section of the TRP SETTING PROGRAM:

- Pre-coding ID48 and ID46 Fiat® transponders.
- Pre-coding Megamos® Crypto transponders for the Volkswagen® Group.
- Pre-coding ID46 Philips® Crypto 2 transponders.
- Identifying PCF component used on original keys with ID46 Philips® Crypto 2 transponders.

 Das Silca Transponder Program wurde mit 226 neuen Auto-Applikationen aktualisiert. Neue Softwareversion 03.20.080 für alle RW-Geräte.

Informieren Sie sich über die Neuigkeiten im Hilfe Bereich des TRP SETTING PROGRAM:

- Vorkodierung Transponders ID48 und ID46 Fiat®.
- Vorkodierung Transponders Megamos® Crypto für die Gruppe Volkswagen®.
- Vorkodierung Transponders ID46 Philips® Crypto 2.
- Identifizierung der PCF-Komponente in den Originalschlüsseln mit transponders ID46 Philips® Crypto 2.

 Se ha actualizado el Silca Transponder Program con 226 nuevas aplicaciones vehículo. Nueva versión de software 03.20.080 para todos los dispositivos RW.

Ver las novedades en la ayuda del programa TRP SETTING PROGRAM:

- Precodificación de los transponders ID48 e ID46 Fiat®.
- Precodificación de los transponders Megamos® Crypto para el grupo Volkswagen®.
- Precodificación de los transponders ID46 Philips® Crypto 2.
- Identificación del tipo de componente PCF usado en las llaves originales con los transponders ID46 Philips® Crypto 2.

 Il Silca Transponder Program è stato aggiornato con 226 nuove applicazioni auto. Nuova versione Software 03.20.080 per tutti i dispositivi RW.

Vedi le novità nell' Aiuto del programma TRP SETTING PROGRAM:

- Precodifica transponder ID48 e ID46 Fiat®.
- Precodifica transponder Megamos® Crypto per il gruppo Volkswagen®.
- Precodifica transponder ID46 Philips® Crypto 2.
- Identificazione tipo componente PCF utilizzato nelle chiavi originali con transponder ID46 Philips® Crypto 2.

 Silca Transponder Program a été mis à jour avec 226 nouvelles applications auto. Nouvelle version Software 03.20.080 pour tous les dispositifs RW.

Voir les nouveautés dans l' Aide du program TRP SETTING PROGRAM:

- Précodage transpondeurs ID48 et ID46 Fiat®.
- Précodage transpondeurs Megamos® Crypto du groupe Volkswagen®.
- Précodage transpondeurs ID46 Philips® Crypto 2.
- Identifier le composant PCF utilisé dans les clés originales à transpondeurs ID46 Philips® Crypto 2.

 O Silca Transponder Program foi actualizado com 226 novas aplicações para automóvel. Nova versão de software 03.20.080 para todos os dispositivos RW.

Vejam as novidades na secção de ajuda do programa TRP:

- Pré-codificação transponders ID48 e ID46 Fiat®.
- Pré-codificação transponders Megamos® Crypto para o grupo Volkswagen®.
- Pré-codificação transponders ID46 Philips® Crypto 2.
- Identificação de tipo de componente PCF utilizado nas chaves originais com transponders ID46 Philips® Crypto 2.

SILCA FUTURA PROGRAM

Data Update with new systems

Software Vers. 2.14.0 - db 1.32
App Vers. 1.21



Futura

Data update with new systems / Aggiornamento dati con nuovi sistemi / Datenaktualisierung mit neuen Systemen / Mise à jour des données avec nouveaux systèmes / Actualización de datos con sistemas nuevos / Atualização de dados com novos sistemas

New items include / Tra le novità / Unter den Neuheiten / Parmi les nouveautés / Entre las novedades / Entre as novidades:

- | | | |
|-----------------------------------|---------------------------------|-------------------------------|
| - Abus® Bravus 1000
(Tip stop) | - Haworth® | - Oxloc® O7 |
| - Abus® Bravus 2000
(Tip stop) | - Honda® | - Oxloc® O8 |
| - Abus® Bravus 4000
(Tip stop) | - Hyundai® | - Pacri (5+5) |
| - Anderson Hickey® | - Hyundai® KIA (DEPTHS
1-5) | - Pundra® |
| - Bauer® | - Ifam® | - Ronis® |
| - Bommer® | - Ifam® E-30 & M-30 | - Sentry® |
| - Chicago® | - Ifam® E-40 & M-40 | - Squire&Sons® ATL4 &
ATL5 |
| - Corbin® | - Ifam® E-50-60-70 &
M-50-60 | - Squire&Sons® KB |
| - Craftsman® | - Ilco® | - Subaru® |
| - Eagle® | - Illinois® | - Taylor® |
| - Eurolocks® | - Kale® 164 DBNE (5+5) | - Toyota® |
| - F.I.C.® | - Minda®-Hur® | - US Lock® |
| - Fastec® | - Mitsubishi® | - Winkhaus® W-Profile |
| - Fort® | - Miwa® | - Winkhaus® XL-Profile |
| - Fort® CH10T (7P) | - National® | |
| | - Oxloc® O9 | |

🇬🇧 Remember to update the Silca.apk and SilcaKeyboard.apk after installing the Software update (see the on board Instructions Manual - Ch. 7.3 APP UPDATE (apk)).

🇮🇹 Ricordarsi di aggiornare Silca.apk e SilcaKeyboard.apk dopo l'installazione dell'aggiornamento (vedi le istruzioni nel Manuale d'uso - Cap. 7.3 AGGIORNAMENTO APP (apk)).

🇩🇪 Behebt Probleme, die beim Software-Update der Maschine über das Tablet entstehen können. Für mehr Details lesen Sie die Bedienungsanleitung (Kap. 7.3 AKTUALISIERUNG APP (apk)).

🇫🇷 N'oubliez pas de mettre à jour Silca.apk et SilcaKeyboard.apk après avoir installé la mise à jour du logiciel (voir le Manuel d'instructions - Ch.7.3 MISE A JOUR APP (apk)).

🇪🇸 No olvidar actualizar Silca.apk y SilcaKeyboard.apk después de instalar la versión actualizada del programa (ver indicaciones a bordo máquina integradas en el Manual - Ch 7.3 ACTUALIZACIÓN APP (apk)).

🇧🇷 Lembrar de atualizar o Silca.apk eo SilcaKeyboard.apk após a instalação da atualização (ver as instruções no Manual de Utilização - Capítulo 7.3 ATUALIZAÇÃO APP (apk)).

Smart Aerial / RW4 Plus / Fast Copy Plus

Software compatibility and options / Compatibilità software e opzioni / Kompatibilität der Software und Optionen
Compatibilité logiciel et options / Compatibilidad software y opciones / Compatibilidade software e opções

December 2015

Advanced Diagnostics are pleased to announce Smart Aerial is compatible with the following software modules for pre-coding. Pre-coding can be done using the programming device AD100 Pro / MVP Pro, Smart Dongle and Smart Aerial, or alternatively the programming device AD100 Pro / MVP Pro, Smart Dongle, Power Cable (ADC243) and RW4 Plus / Fast Copy Plus.

Smart Aerial ist mit den folgenden Software-Modulen für die Vorcodierung kompatibel. Die Vorcodierung kann mit den Programmiergeräten AD100 Pro / MVP Pro, Smart Dongle und Smart Aerial, oder alternativ mit dem Programmiergerät AD100 Pro / MVP Pro, Smart Dongle, Power Cable (ADC243) und RW4 Plus / Fast Copy Plus erfolgen.

Smart Aerial es compatible con los siguientes módulos software que permiten efectuar la precodificación. La precodificación puede efectuarse mediante el uso del dispositivo de programación AD100 Pro / MVP Pro, Smart Dongle y Smart Aerial, o sino con el dispositivo de programación AD100 Pro / MVP Pro, Smart Dongle, el cable Power Cable (ADC243) y RW4 Plus / Fast Copy Plus.

Smart Aerial è compatibile con i seguenti moduli software con i quali è possibile effettuare la pre-codifica. La pre-codifica può essere effettuata utilizzando il dispositivo di programmazione AD100 Pro / MVP Pro, Smart Dongle e Smart Aerial, o in alternativa con il dispositivo di programmazione AD100 Pro / MVP Pro, Smart Dongle, il cavo Power Cable (ADC243) e RW4 Plus / Fast Copy Plus.

Smart Aerial est compatible avec les modules logiciel de précodage suivants. Le précodage peut être fait avec le dispositif de programmation AD100 Pro / MVP Pro, Smart Dongle et Smart Aerial ou, en alternative, avec le dispositif de programmation AD100 Pro / MVP Pro, Smart Dongle, le câble Power Cable (ADC243) et RW4 Plus / Fast Copy Plus.

Smart Aerial é compatível com os seguintes módulos de software com os quais é possível efetuar a pré-codificação. A pré-codificação pode ser efetuada utilizando o dispositivo de programação AD100 Pro / MVP Pro, Smart Dongle e Smart Aerial, ou em alternativa com AD100 Pro / MVP Pro, Smart Dongle, o cabo Power Cable (ADC243) e RW4 Plus / Fast Copy Plus.



FIAT® 2012 PIN CODE READ
D745337AD
ADS185



FIAT® 2015
D746536AD
ADS231



FIAT® 2015 SAM
D746561AD
ADS247



VAG® 2013
D745345AD
ADS219

Pre-coding options / Opzioni di pre-codifica / Vorcodierungsoptionen / Options de précodage / Opciones de precodificación / Opções de pré-codificação



MVP PRO / AD100 PRO



SMART DONGLE



SMART AERIAL



RW4 PLUS / FAST COPY PLUS



POWER CABLE
D746406AD - ADC243





Fiat® 2015 Key Programming Software ADS247 (SOUTH AMERICA) - Code D746561AD

Smart Dongle and Smart Aerial compatible

December 2015





 ADS247 key programming software now includes **pin code reading and pre-coding for Fiat® vehicles specific to the South and Central American market**. Pre-coding can be performed seamlessly in the background using Smart Aerial and Smart Dongle, enabling the locksmith to pre-code a blank transponder without switching to another device or tool.

 Il software di programmazione chiavi veicolo ADS247 comprende le funzioni di **lettura codici pin e la pre-codifica di veicoli Fiat® circolanti nel Centro e Sud America**. La pre-codifica può essere effettuata in background utilizzando Smart Dongle e Smart Aerial, permettendo di pre-codificare un transponder vergine senza dover utilizzare altri dispositivi.

 Die Software zur Kfz-Schlüsselprogrammierung ADS247 umfasst **Pincode-Lese- und Vorcodierungsfunktionen für Fiat® Fahrzeuge, die hauptsächlich in Süd- und Zentralamerika verkehren**. Das Vorcodieren kann in Background mit Smart Aerial und Smart Dongle durchgeführt werden, so kann ein leerer Transponder ohne den Einsatz von weiteren Geräten vorcodiert werden.

 Le software de programmation de clés véhicule ADS247 comprend les fonctions de **lecture des codes pin et la précodage de véhicules Fiat® circulant spécifiquement dans les marchés de l'Amérique Centrale et du Sud**. Le précodage pourra être fait en background avec Smart Dongle et Smart Aerial, ce qui vous permettra de précoder un transpondeur vierge sans devoir utiliser d'autres dispositifs.

 El software para la programación de llaves de vehículo ADS247 comprende las funciones de **lectura de códigos pin y la precodificación de vehículos Fiat® en circulación específicamente en América Central y Sudamérica**. La precodificación puede efectuarse en el fondo mediante Smart Dongle y Smart Aerial, por lo que permite precodificar un transponder virgen sin usar otros dispositivos.

 O software de programação de chaves para veículo ADS247 inclui todas as funções de **leitura dos códigos pin e a pré-codificação de veículos Fiat® que circulam especificadamente na América Central e do Sul**. A pré-codificação pode ser efectuada em background utilizando Smart Dongle e Smart Aerial, permitindo pré-codificar um transponder virgem sem ter de utilizar outros dispositivos ou acessórios.

DETAILS OFFER

Cable	ADC250 or ADC251
Dongle	Smart Dongle and Smart Aerial or Smart Dongle +RW4 Plus/Fast Copy Plus+cable Power Cable (ADC243)
Software category	A
Other software required	ADS185
Smart card	Smart Dongle

www.silca.biz - www.silca-automotive.com - www.advanced-diagnostics.com



Fiat® Software Applications

Fiat® 2015 Software - ADS247 (South America)

TABLE

							
Fiat® Bravo (Blade) 2010 to 2014	✓	✓	✓	✓	ADC250 or ADC251	Smart Dongle	✗
Fiat® Doblò (Blade) 2000 to 2003	✓	✓	✓	✓	ADC250 or ADC251	Smart Dongle	✗
Fiat® Doblò (Blade) 2004 to 2012	✓	✓	✓	✓	ADC250 or ADC251	Smart Dongle	✗
Fiat® Fiorino (Blade) VDO Cluster 2014 Onwards	✓	✓	✓	✓	ADC250 or ADC251	Smart Dongle	✗
Fiat® Fiorino (Blade) Marelli Cluster 2015 Onwards	✓	✓	✓	✓	ADC250 or ADC251	Smart Dongle	✗
Fiat® Grand Siena (Blade) 2012 Onwards	✓	✓	✓	✓	ADC250 or ADC251	Smart Dongle	✗
Fiat® Idea (Blade) 2004 to 2012	✓	✓	✓	✓	ADC250 or ADC251	Smart Dongle	✗
Fiat® Linea (Blade) 2008 to 2014	✓	✓	✓	✓	ADC250 or ADC251	Smart Dongle	✗
Fiat® Palio (Blade) 2000 to 2003	✓	✓	✓	✓	ADC250 or ADC251	Smart Dongle	✗
Fiat® Palio (Blade) 2004 to 2011	✓	✓	✓	✓	ADC250 or ADC251	Smart Dongle	✗
Fiat® Palio (Blade) 2012 Onwards	✓	✓	✓	✓	ADC250 or ADC251	Smart Dongle	✗

🇬🇧 Important note: To prevent damage to Smart Dongle, ensure that the ignition is turned off when connecting the programmer to the vehicle. **Please visit the Advanced Diagnostics website to see the Smart Aerial training video procedure.**

🇮🇹 Nota importante: Per prevenire eventuali danni al dispositivo Smart Dongle, assicurarsi che il motore sia spento nel momento in cui il dispositivo di programmazione viene collegato al veicolo. **Visita il sito di Advanced Diagnostics per vedere il video tutorial che spiega come utilizzare Smart Aerial.**

🇩🇪 Wichtiger Hinweis: um mögliche Schäden am Smart Dongle-Gerät zu vermeiden, verbinden Sie das Programmierungsgerät nur bei ausgeschaltetem Motor an das Fahrzeug. **Auf der Webseite von Advanced Diagnostics finden Sie die Videoanleitung für den Einsatz von Smart Aerial.**









www.silca.biz - www.silca-automotive.com - www.advanced-diagnostics.com



Fiat® Software Applications

Fiat® 2015 Software - ADS247 (South America)

TABLE

							
Fiat® Palio (Blade) Marelli Cluster 2008 to 2010	✓	✓	✓	✓	ADC250 or ADC251	Smart Dongle	✗
Fiat® Palio (Blade) VDO Cluster 2008 to 2010	✓	✓	✓	✓	ADC250 or ADC251	Smart Dongle	✗
Fiat® Punto (Blade) 2008 to 2014	✓	✓	✓	✓	ADC250 or ADC251	Smart Dongle	✗
Fiat® Strada (Blade) 2000 to 2003	✓	✓	✓	✓	ADC250 or ADC251	Smart Dongle	✗
Fiat® Strada (Blade) 2012 Onwards	✓	✓	✓	✓	ADC250 or ADC251	Smart Dongle	✗
Fiat® Uno (Blade) VDO Cluster 2011 Onwards	✓	✓	✓	✓	ADC250 or ADC251	Smart Dongle	✗
Fiat® Uno (Blade) Marelli Cluster 2015 Onwards	✓	✓	✓	✓	ADC250 or ADC251	Smart Dongle	✗

Remarque importante: pour prévenir d'éventuels dégâts sur le dispositif Smart Dongle, assurez-vous que le moteur soit éteint au moment où le dispositif de programmation est connecté au véhicule. **Une visite sur le site Advanced Diagnostics vous permettra de voir la vidéo tutorielle expliquant comment utiliser Smart Aerial.**

Nota importante: para prevenir daños al dispositivo Smart Dongle, asegurarse de que el motor se haya apagado cuando el dispositivo de programación se conecta al vehículo. **Entra en el sitio de Advanced Diagnostics para ver el vídeo tutorial que explica el modo de usar Smart Aerial.**

Anotação importante: para prevenir eventuais danos no dispositivo Smart Dongle, certificar-se de que o motor está desligado no momento em que o dispositivo de programação é ligado ao veículo. **Visite o site de Advanced Diagnostics para ver o vídeo tutorial que explica como utilizar Smart Aerial.**

www.silca.biz - www.silca-automotive.com - www.advanced-diagnostics.com

Nissan® 2015 Key Programming Software ADS249 (SOUTH AMERICA) - Code D746568AD

December 2015



UK ADS249 key programming software for Nissan® 2015 vehicles found in South America allows keys to be added or programmed from a lost key situation. The software has been designed to read the 12 digit pin code data automatically in the background, making it a seamless process when programming keys. ADS159 software required.

IT Il software ADS249 permette di aggiungere o programmare chiavi per alcuni veicoli Nissan® diffusi in Sud America anche nel caso in cui la chiave originale sia andata persa. Il software consente la lettura del codice pin a 12 cifre, che viene effettuata automaticamente in background, rendendo la procedura di programmazione semplice e veloce. È richiesto anche il software ADS159.



















DE Mit der Software ADS249 können Schlüssel einiger Nissan®-Modelle, die in Südamerika verbreitet sind, hinzugefügt oder programmiert werden auch wenn der Originalschlüssel verloren gegangen ist. Mit der Software können 12stellige Codes automatisch im Background gelesen werden, so dass die Schlüsselprogrammierung einfach und schnell erfolgt. Software ADS159 erforderlich.

FR Le logiciel ADS249 permet d'ajouter ou de programmer des clés pour certains modèles de véhicules Nissan® diffus en Amérique du Sud même quand on a perdu la clé originale. Ce logiciel permet de lire des codes pin à 12 chiffres, en background automatique, ce qui rend la programmation de la clé plus simple et rapide. Logiciel ADS249 requis.

ES El software ADS249 permite añadir o programar llaves para algunos modelos del vehículo Nissan® difundidos en Sudamérica también cuando se ha perdido la llave original. El software permite la lectura del código pin de 12 dígitos, que se efectúa automáticamente de fondo, por lo que el procedimiento de programación de la llave es sencillo y rápido. Se requiere el software ADS159.

PT O software ADS249 permite adicionar ou programar chaves para alguns modelos de veículo Nissan® difundidos na América do Sul também no caso de perda da chave original. O software permite a leitura do código pin de 12 algarismos, que é efetuada automaticamente em background, tornando o procedimento de programação da chave mais simples e rápido. Software ADS159 necessário.

TABLE

								
Nissan® Livina (Blade) 2010 to 2013		 Manual procedure			ADC250 or ADC251	G or Smart Dongle		
Nissan® March (Blade) 2011 Onwards		 Manual procedure			ADC250 or ADC251	G or Smart Dongle		



FREE Software Update for Ford® ADS100 (South America) - Code D745306AD

December 2015



UK The ADS100 update applies to the South American market for selected Ford® vehicles. The key programming procedure is a timed access operation that takes 10 minutes to complete and does not require a pin code. This software allows keys to be added or programmed from a lost key situation.

IT L'aggiornamento software ADS100 è dedicato specificatamente a veicoli Ford® in circolazione in Sud America. La procedura di programmazione della chiave è a tempo, richiede circa 10 minuti per essere completata e non necessita di un codice pin. Il software consente di aggiungere o programmare una chiave anche nel caso in cui la chiave originale sia andata persa.

DE Das Softwareupdate ADS100 wurde spezifisch für Ford® Fahrzeuge, die in Südamerika zirkulieren, entwickelt. Der Schlüsselprogrammierungsvorgang ist zeitbestimmt, dauert ca. 10 Minuten und braucht kein Pincode. Mit dieser Software können Schlüssel hinzugefügt oder programmiert werden auch wenn der Originalschlüssel verloren gegangen ist.









FR La mise à jour du logiciel ADS100 est spécialement consacrée aux véhicules Ford® en circulation en Amérique du Sud. La procédure de programmation de la clé est à durée déterminée; il faut dix minutes pour la compléter et aucun code pin n'est nécessaire. Ce logiciel permet d'ajouter ou de programmer une clé même quand on a perdu la clé originale.



ES La actualización del software ADS100 está dedicada específicamente a los vehículos Ford® en circulación en Sudamérica. El procedimiento de programación de la llave requiere 10 minutos aproximadamente para completarse y no necesita un código pin. El software permite añadir o programar una llave también cuando se ha perdido la llave original.

PT A atualização de software ADS100 é dedicada especificadamente aos veículos Ford®, que circulam na América do Sul. O procedimento de programação da chave é a tempo, demora aprox. 10 minutos para se completar e não necessita de um código pin. O software permite adicionar ou programar uma chave também no caso de perda da chave original.

TABLE

							
Ford® F250 Cummins (Blade) Up to 2007	✓	✓ Manual procedure	✗	✗	ADC250 or ADC251	A or Smart Dongle	✗
Ford® F350 Cummins (Blade) Up to 2007	✓	✓ Manual procedure	✗	✗	ADC250 or ADC251	A or Smart Dongle	✗



*Silca wishes you joyful
Winter Holidays and
a Happy New Year*

