

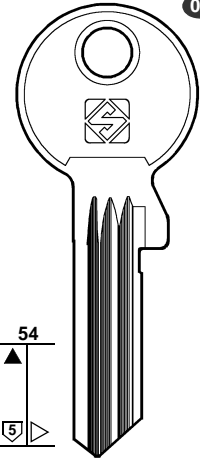

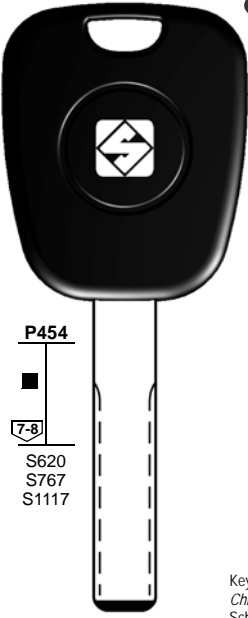

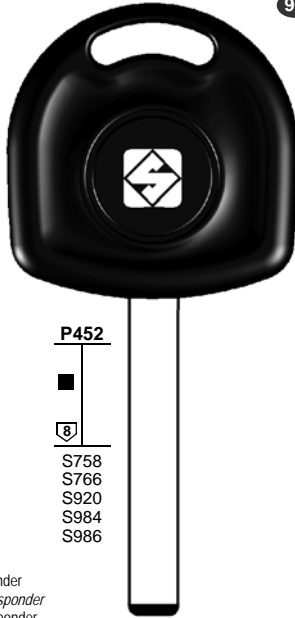





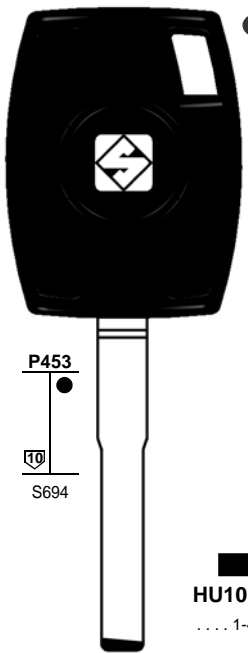
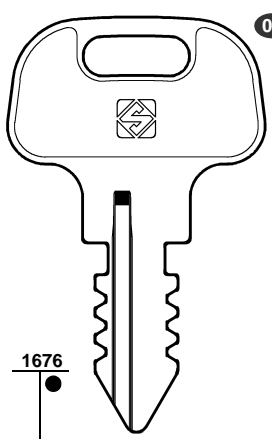

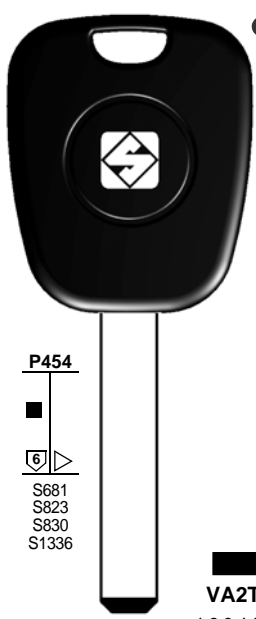











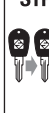











New keys / Chiavi Nuove / Neue Schlüssel / Nouvelles Clés
Llaves Nuevas / Chaves Nuevas

FOR: PER:	HUGO	HUF		FOR / PER
	 <p>05</p> <p>54</p> <p>5</p> <p>HGO2R</p>	 <p>97</p> <p>P454</p> <p>7-8</p> <p>S620 S767 S1117</p> <p>HU83TE 1-2000</p>	 <p>97</p> <p>P452</p> <p>8</p> <p>S758 S766 S920 S984 S986</p> <p>HU100TE Z 1-2000 Z 2001-4000 Z 4001-6000</p> <p>VALEO</p>	<p>HUGO (D)</p> <p>HUF (D) VALEO</p> <p>KUBOTA (GR)</p> <p>VALEO (F) +  HUF (1)</p>
	<p>Key with Adapter / whitout Transponder Chiave con Adattatore / senza Transponder Schlüssel mit Adapter / ohne Transponder Clé avec Adaptateur / sans Transpondeur Llaves con Adaptador / sin Transponder Chave com Adaptador / sem Transponder</p>			
FOR: PER:	HUF	KUBOTA	VALEO	
	 <p>97</p> <p>P453</p> <p>10</p> <p>S694</p> <p>HU101TE 1-4000</p>	 <p>05</p> <p>1676</p> <p>6</p> <p>KUB2R</p> <p></p>	 <p>97</p> <p>P454</p> <p>6</p> <p>S681 S823 S830 S1336</p> <p>VA2TE 1-2-3-4-Q-5-6-7-8-H A-B-C-D-E-F</p>	
	<p>Key with Adapter / whitout Transponder Chiave con Adattatore / senza Transponder Schlüssel mit Adapter / ohne Transponder Clé avec Adaptateur / sans Transpondeur Llaves con Adaptador / sin Transponder Chave com Adaptador / sem Transponder</p>		<p>Key with Adapter / whitout Transponder Chiave con Adattatore / senza Transponder Schlüssel mit Adapter / ohne Transponder Clé avec Adaptateur / sans Transpondeur Llaves con Adaptador / sin Transponder Chave com Adaptador / sem Transponder</p>	
				<p>01</p> <p>COMMERCIAL GROUP GRUPPO COMMERCIALE PREISEGRUPPE GROUPE COMMERCIAL GRUPO COMMERCIAL GRUPO COMMERCIAL</p> <p>www.silca.biz</p>

1	2	2a	3	3a	E1+E2		6	42+71	72	43 44a	12	15	A	B	C	D
CAR MAKE/MODEL 	FROM	FROM	SILCA REF. 	SILCA REF. 	COPY 	GEN. 	TRANSP. TYPE 	ID 	COPY 	COPY 	STP 					
	1995	2013	Ref.	"TE" Silca Ref.				FAST COPY PLUS RW4 PLUS FAST COPY/RW4	FAST COPY PLUS RW4 PLUS	FAST COPY RW4						
BUICK®																
ALLURE	2010		HU100MH	HU100TE	Y		PH / CR2	46	Y	P-BOX			↔	↔	↔	↔
LACROSSE	2010		HU100MH	HU100TE	Y		PH / CR2	46	Y	P-BOX			↔			
REGAL	2011		HU100MH	HU100TE	Y		PH / CR2	46	Y	P-BOX						
VERANO	2012		HU100MH	HU100TE	Y		PH / CR2	46	Y	P-BOX						
CADILLAC®																
SRX	2010		HU100MH	HU100TE	Y		PH / CR2	46	Y	P-BOX			↔			
CHEVROLET SUD AMERICA®																
AGILE	2009		HU100MH	HU100TE	Y		PH / CR2	46	Y	P-BOX			↔	↔		↔
CHEVROLET USA®																
CAMARO	2010		HU100MH	HU100TE	Y		PH / CR2	46	Y	P-BOX			↔	↔	↔	↔
CRUZE	2011		HU100MH	HU100TE	Y		PH / CR2	46	Y	P-BOX			↔			
EQUINOX	2010		HU100MH	HU100TE	Y		PH / CR2	46	Y	P-BOX			↔			
MALIBU	2013		HU100MH	HU100TE	Y		PH / CR2	46	Y	P-BOX			↔			
ORLANDO	2012		HU100MH	HU100TE	Y		PH / CR2	46	Y	P-BOX			↔			
SONIC	2012		HU100MH	HU100TE	Y		PH / CR2	46	Y	P-BOX			↔			
VOLT	2011		HU100MH	HU100TE	Y		PH / CR2	46	Y	P-BOX						
CHEVROLET-DAEWOO®																
AVEO	2011		HU100MH	HU100TE	Y		PH / CR2	46	Y	P-BOX			↔			
CRUZE	2009		HU100MH	HU100TE	Y		PH / CR2	46	Y	P-BOX			↔	↔		↔
MALIBU	2012		HU100MH	HU100TE	Y		PH / CR2	46	Y	P-BOX			↔			
ORLANDO	2011		HU100MH	HU100TE	Y		PH / CR2	46	Y	P-BOX			↔			
TRAX	2013		HU100MH	HU100TE	Y		PH / CR2	46	Y	P-BOX			↔			
VOLT	2012		HU100MH	HU100TE	Y		PH / CR2	46	Y	P-BOX			↔			
CITROËN®																
C4 PICASSO	2006		HU83MH	HU83TE	Y	Y	PH / CR2	46	Y	P-BOX			↔	↔		↔
C5	2008		HU83MH	HU83TE	Y	Y	PH / CR2	46	Y	P-BOX			↔			
C8	2002		HU83MH	HU83TE	Y	Y	PH / CR2	46	Y	P-BOX			↔			↔
DISPATCH	2007		HU83MH	HU83TE	Y	Y	PH / CR2	46	Y	P-BOX			↔	↔		↔
JUMPY	2007		HU83MH	HU83TE	Y	Y	PH / CR2	46	Y	P-BOX			↔	↔		↔
DODGE®																
DAKOTA	2005	2011	CY24EHP				PH / CR2	46	Y	P-BOX			↔	↔		↔
DAKOTA	2005	2011	CY24MH		Y	Y	PH / CR2	46	Y	P-BOX			↔	↔		↔
DAKOTA	2005	2011	Y164-PT				PH / CR2	46				F	↔	↔		↔
DURANGO	2005	2009	CY24EHP				PH / CR2	46	Y	P-BOX			↔	↔		↔
DURANGO	2005	2009	CY24MH		Y	Y	PH / CR2	46	Y	P-BOX			↔	↔		↔

Car Keys Guide / Guida Chiavi Auto / Führer für Autoschlüssel / Guide Clés pour Voitures
 Guía Llaves para Coches / Guia Chaves para Carros

New Updates

1	2	2a	3	3a	E1+E2		6	42+71	72	43 44a	12	15	A	B	C	D
					GT1 Compatibility											
CAR MAKE/MODEL	FROM	FROM	SILCA REF.	SILCA REF.	COPY	GEN.	TRANSP. TYPE	ID	COPY	COPY	STP					
																
	1995	2013	Ref.	"TE" Silca Ref.				FAST COPY PLUS RW4 PLUS FAST COPY/RW4	FAST COPY PLUS RW4 PLUS	FAST COPY RW4						
DODGE®																
DURANGO	2005	2009	Y164-PT				PH / CR2	46					↔	↔		↔
MAGNUM	2005	2008	CY24EHP				PH / CR2	46	Y	P-BOX			↔	↔	↔	↔
MAGNUM	2005	2008	CY24MH		Y	Y	PH / CR2	46	Y	P-BOX			↔	↔	↔	↔
MAGNUM	2005	2008	Y164-PT				PH / CR2	46				F	↔	↔	↔	↔
RAM	2006	2011	CY24EHP				PH / CR2	46	Y	P-BOX			↔	↔	↔	↔
RAM	2006	2011	CY24MH		Y	Y	PH / CR2	46	Y	P-BOX			↔	↔	↔	↔
RAM	2006	2011	Y164-PT				PH / CR2	46				F	↔	↔	↔	↔
FIAT®																
SCUDO	2007		HU83MH	HU83TE	Y	Y	PH / CR2	46	Y	P-BOX			↔	↔		↔
ULYSSE	2002	2011	HU83MH	HU83TE	Y	Y	PH / CR2	46	Y	P-BOX			↔	↔	↔	↔
FORD AUS®																
BF FALCON	2005		HU101MH	HU101TE	Y	Y	TEX / CR2	6F	Y	P-BOX			↔	↔	↔	↔
TERRITORY	2005		HU101MH	HU101TE	Y	Y	TEX / CR2	6F	Y	P-BOX			↔	↔		↔
FORD EU®																
FIESTA	2008	2012	HU101MH	HU101TE	Y	Y	TEX / CR	63	Y	P-BOX			↔			
FOCUS	2004	2010	HU101MH	HU101TE	Y	Y	TEX / CR	63	Y	P-BOX			↔	↔		↔
FOCUS C-MAX	2003	2010	HU101MH	HU101TE	Y	Y	TEX / CR	63	Y	P-BOX			↔	↔		↔
GALAXY	2006	2010	HU101MH	HU101TE	Y	Y	TEX / CR	63	Y	P-BOX			↔	↔		↔
KUGA	2008		HU101MH	HU101TE	Y	Y	TEX / CR	63	Y	P-BOX			↔			↔
MONDEO	2007	2010	HU101MH	HU101TE	Y	Y	TEX / CR	63	Y	P-BOX			↔	↔		
S-MAX	2006	2010	HU101MH	HU101TE	Y	Y	TEX / CR	63	Y	P-BOX			↔	↔		↔
FORD SUD AMERICA®																
MONDEO	2007		HU101MH	HU101TE	Y	Y	TEX / CR	63	Y	P-BOX			↔			
GMC (GM)®																
TERRAIN	2010		HU100MH	HU100TE	Y		PH / CR2	46	Y	P-BOX			↔			
HOLDEN®																
ASTRA	2004		HU100MH	HU100TE	Y		PH / CR2	46	Y	P-BOX			↔	↔		↔
VECTRA	2004		HU100MH	HU100TE	Y		PH / CR2	46	Y	P-BOX			↔	↔		↔
ZAFIRA	2004		HU100MH	HU100TE	Y		PH / CR2	46	Y	P-BOX			↔	↔		↔
LANCIA®																
PHEDRA	2002	2011	HU83MH	HU83TE	Y	Y	PH / CR2	46	Y	P-BOX			↔	↔	↔	↔
LAND-ROVER®																
DISCOVERY 3	2006	2009	HU101MH	HU101TE	Y		PH / CR2	46	Y	P-BOX			↔	↔		↔
RANGE ROVER SPORT	2006	2009	HU101MH	HU101TE	Y		PH / CR2	46	Y	P-BOX			↔	↔		↔

Car Keys Guide / Guida Chiavi Auto / Führer für Autoschlüssel / Guide Clés pour Voitures
 Guía Llaves para Coches / Guia Chaves para Carros

New Updates

1	2	2a	3	3a	E1+E2		6	42+71	72	43 44a	12	15	A	B	C	D				
					GTI Compatibility															
CAR MAKE/MODEL	FROM	FROM	SILCA REF.	SILCA REF.	COPI	GEN.	TRANSP. TYPE	ID	COPI	COPI	STP									
	1995 	2013 	 Ref.	 "TE" Silca Ref.				 FAST COPY PLUS RW4 PLUS FAST COPY/RW4	 FAST COPY PLUS RW4 PLUS	 FAST COPY RW4										
LINCOLN®																				
MKT	2010		SMART KEY				TEX / CR	63												
OPEL-VAUXHALL®																				
ADAM	2013		HU100MH	HU100TE	Y		PH / CR2	46	Y	P-BOX			↔							
AMPERA	2012		HU100MH	HU100TE	Y		PH / CR2	46	Y	P-BOX			↔							
ASTRA	2004		HU100MH	HU100TE	Y		PH / CR2	46	Y	P-BOX			↔	↔			↔			
CABRIO	2013		HU100MH	HU100TE	Y		PH / CR2	46	Y	P-BOX			↔							
CASCADA	2013		HU100MH	HU100TE	Y		PH / CR2	46	Y	P-BOX			↔							
CORSA	2006		HU100MH	HU100TE	Y	Y	PH / CR2	46	Y	P-BOX			↔	↔			↔			
INSIGNA	2008		HU100MH	HU100TE	Y		PH / CR2	46	Y	P-BOX			↔	↔			↔			
MERIVA	2010		HU100MH	HU100TE	Y		PH / CR2	46	Y	P-BOX										
MOKKA	2012		HU100MH	HU100TE	Y		PH / CR2	46	Y	P-BOX			↔							
SIGNUM	2003	2008	HU100MH	HU100TE	Y		PH / CR2	46	Y	P-BOX			↔	↔			↔			
VECTRA	2004	2008	HU100MH	HU100TE	Y		PH / CR2	46	Y	P-BOX			↔	↔	↔		↔			
ZAFIRA	2006		HU100MH	HU100TE	Y		PH / CR2	46	Y	P-BOX			↔	↔	↔		↔			
PEUGEOT®																				
207	2006		HU83MH	HU83TE	Y	Y	PH / CR2	46	Y	P-BOX			↔	↔			↔			
208	2012		HU83MH	HU83TE	Y	Y	PH / CR2	46	Y	P-BOX			↔				↔			
307	2001	2009	HU83MH	HU83TE	Y	Y	PH / CR2	46	Y	P-BOX			↔	↔			↔			
308	2007		HU83MH	HU83TE	Y	Y	PH / CR2	46	Y	P-BOX			↔	↔			↔			
807	2002		HU83MH	HU83TE	Y	Y	PH / CR2	46	Y	P-BOX			↔	↔			↔			
2008	2013		HU83MH	HU83TE	Y	Y	PH / CR2	46	Y	P-BOX			↔				↔			
3008	2009		HU83MH	HU83TE	Y	Y	PH / CR2	46	Y	P-BOX			↔							
5008	2009		HU83MH	HU83TE	Y	Y	PH / CR2	46	Y	P-BOX			↔							
EXPERT	2007		HU83MH	HU83TE	Y	Y	PH / CR2	46	Y	P-BOX			↔	↔			↔			
RCZ	2010		HU83MH	HU83TE	Y	Y	PH / CR2	46	Y	P-BOX			↔	↔	↔					
SATURN (GM)®																				
ASTRA	2008	2009	HU100MH	HU100TE	Y		PH / CR2	46	Y	P-BOX			↔	↔						
SMART®																				
FORTWO	2009		VA2MH	VA2TE	Y		PH / CR2	46	Y	P-BOX										

® are Registered Trademarks.

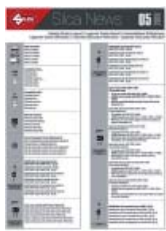

IMPORTANT NOTE:

See also "Vehicle Guide Legend"
 Vedi anche "Legenda Guida Veicoli"
 Siehe auch "Autoschlüssel Erläuterung"
 Voir aussi "Légende Guide Véhicules"
 Véase también "Leyenda Guía para Vehículos"
 Veja também "Legenda Guia para Veículos"





31/01/2014

A NEW ERA IS COMING
STEP INTO THE FUTURE
OF KEY DUPLICATION



STAY TUNED ON WWW.SILCA.BIZ



New Flip Keys / Nuove Chiavi Flip / Neue Klappschlüssel / Nouvelles Clés Flip
Nuevas Llaves Plegables / Nuevas Chaves Dobráveis



SILCA FLIP KEYS
CHOOSE THE BEST
FOR YOUR VEHICLE



WWW.SILCA.BIZ

FOR / PER
CHEVROLET - DAEWOO (ROK)
CHRYSLER (USA)
FORD (EU)
FORD (USA)
GIOBERT (I) + TRW-SIPEA (6)
HONDA (J)
HUF (D) VALEO WITTE

FOR: CHEVROLET - DAEWOO
PER:

DW04RFH
J.... 1-1200
T.... 1-1200
M.... 1-1200

DW05FH
T.... 1-1200
L.... 1-1200
V.... 1-1200
V.... 2001-3200

FOR: CHRYSLER
PER:

CY24FH
L.... 1-3580
M.... 1-2618
FT.... 1001-3000

FOR: FORD EU
PER:

FO21FH
S755
P52
P435
T.... 1-1050
T.... 1-2330
T.... 1051-2330
T.... 1-2-3-4

FOR: FORD USA
PER:

FO38RFH
... A... 101-381.501-579
... B... 101-410.501-602
... C... 101-404.501-624
... D... 101-340.501-602
... E... 101-304.501-579
... X 1-1706

FO26FH
... A... 101-381.501-579
... B... 101-410.501-602
... C... 101-404.501-624
... D... 101-340.501-602
... E... 101-304.501-579

FOR: HONDA
PER:

HON58RFH
... 5001-8442
... 10001-15000

HON66FH
S582
S619
S805
S806
... (SUB) K001-N718
... (MAIN) K001-N718

HON70FH
... 1-2-3
... 5001-8442

FOR: HUF
PER:

HU56RFH
DH....
1-4000
6001-8000

HU66FH
... 1-2000
... 0001-6000
1ATS.... 00001-17850

HU83FH
... 1-2000

HU43FH
H.... 1-3000
WH.... 1-3000
WY.... 1-3000
Y.... 1-3000

01
COMMERCIAL GROUP
GRUPPO COMMERCIALE
PREISEGRUPPE
GROUPE COMMERCIAL
GRUPO COMMERCIAL
GRUPO COMERCIAL

Flip Keys

www.silca.biz

FOR:
PER:

HUF

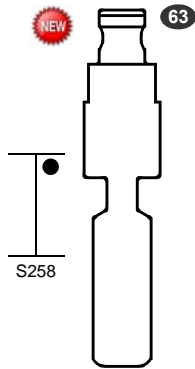

HU71FH
..... 1-2000

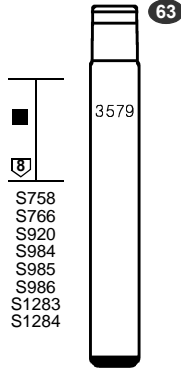

- S758
- S766
- S920
- S984
- S985
- S986
- S1283
- S1284

HU100FH

- Z 1-2000
- Z 2001-4000
- Z 4001-6000
- 0001-3679

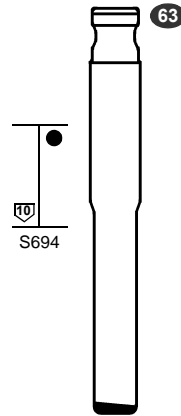

HU101FH
..... 1-4000

FORD

FOR:
PER:

HUF

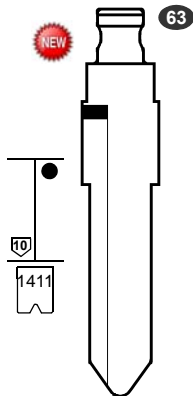

HU87RFH
..... 50001-51308

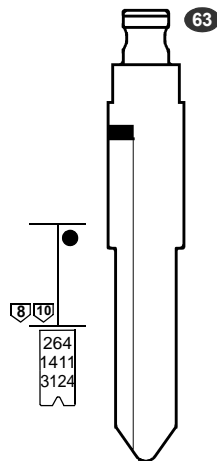

HU133RFH
..... 50001-51308
U 1-2000
IP 5001-6308

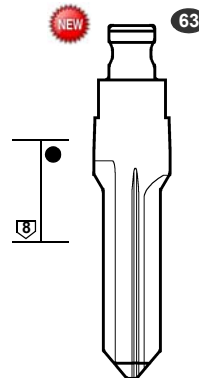

HU136FH

FOR:
PER:

HYUNDAI

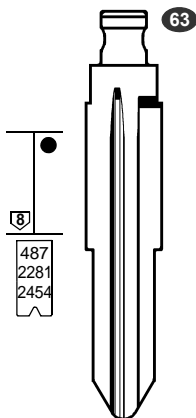

HYN6FH
A 1-1000
R 1-1000
T 1-1000
V 1-1200

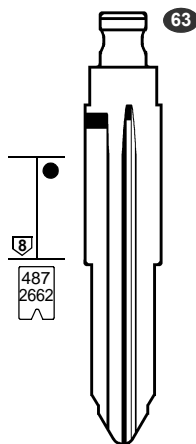

HYN7RFH
S 1-1000

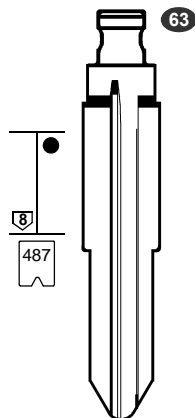

HYN10FH
R 1-1000
K 1-1000
X 1-1000

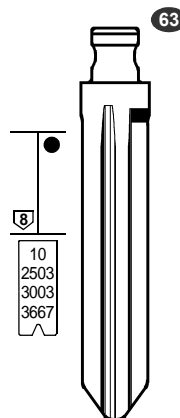

HYN14FH
H 0001-2500
M 0001-2500
P 0001-2500
T 0001-2500
V 1-2500

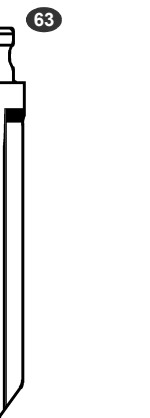

HYN14RFH
M 1-2500
T 1-2500
WC 1001-3500

FOR / PER

HUF (D)

HYUNDAI (ROK)

01







COMMERCIAL GROUP
GRUPPO COMMERCIALE
PREISEGRUPPE
GROUPE COMMERCIAL
GRUPO COMMERCIAL
GRUPO COMERCIAL



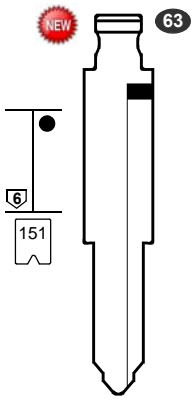

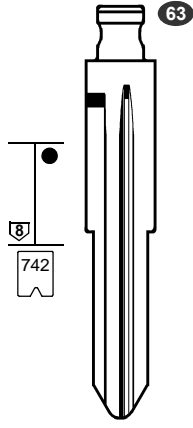

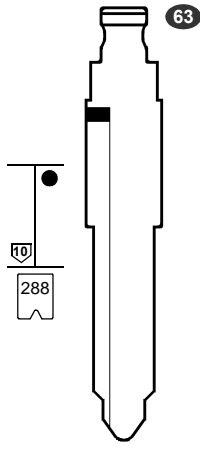
Flip Keys



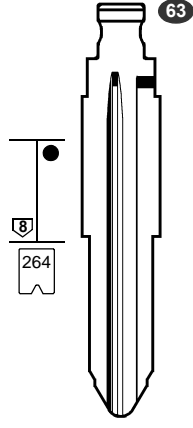

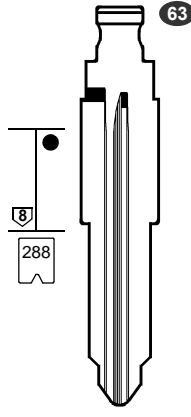

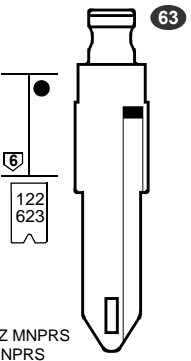

www.silca.biz

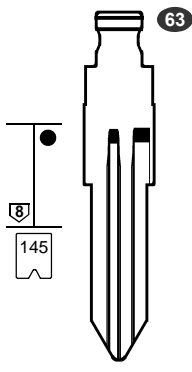
FOR / PER
KAWASAKI (J)
KIA (ROK)
MAZDA (J)
MITSUBISHI (J)
NEIMAN (F) VALEO +  VALEO (6)
NISSAN (J) VALEO

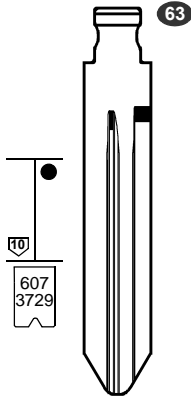
FOR: PER:	KAWASAKI	KIA	MAZDA
	 <p>KW16FH Z 5001-6000</p> 	 <p>KIA3RFH Y 2001-3000</p> 	 <p>MAZ24RFH 10100-12283</p> 

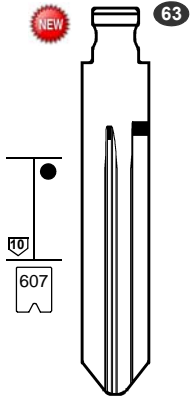
FOR: PER:	MITSUBISHI	NEIMAN	
	 <p>MIT8FH E 5001-7000 E 7001-7700</p> 	 <p>MIT11RFH 30010-32009</p> 	 <p>NE73FH</p> <p>..... 1/9 ... A/AZ MNPRS 1/9 ... A/Z MNPRS 1/9 ... A/Z MNPRS 1/9 ... A/Z MNPRS 1/9 ... A/Z MNPRS 1/9 ... A/Z MNPRS 0/90/9 MNPRS 1/9 . A/Z MNPRS</p>  <p> VALEO</p>

FOR: PER:	NISSAN		
	 <p>NSN11FH X 1-8000 X 8001-9000</p>  <p>VALEO SUBARU</p>	 <p>NSN14FH 1-22185</p> 	 <p>NSN19FH 30001-37850 1-22185</p> 





01

COMMERCIAL GROUP
GRUPPO COMMERCIALE
PREISEGRUPPE
GROUPE COMMERCIAL
GRUPO COMMERCIAL
GRUPO COMERCIAL

Flip Keys

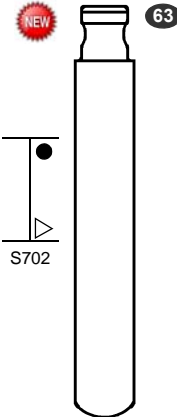
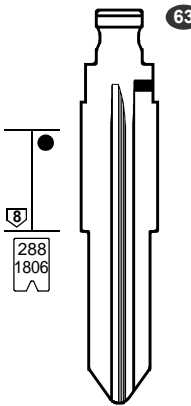
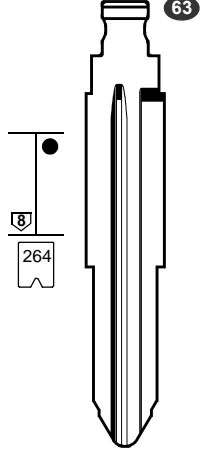
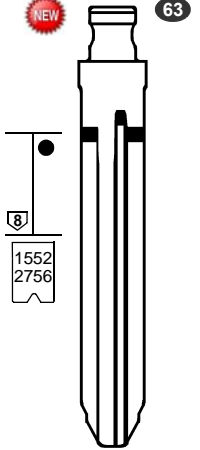
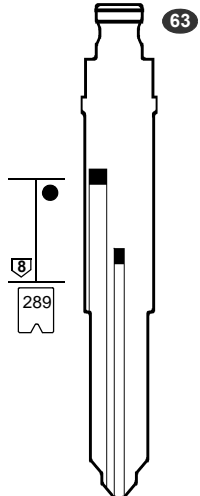

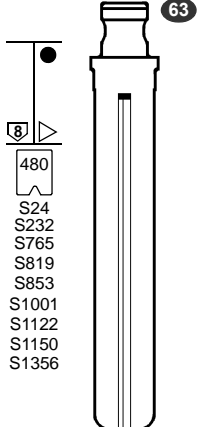
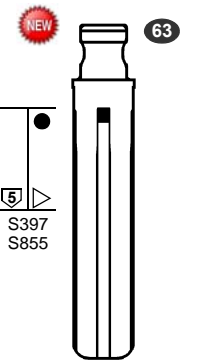
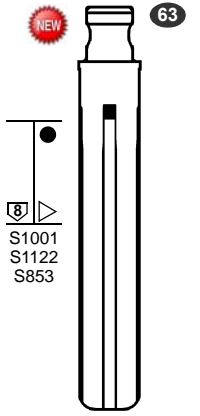
www.silca.biz

FOR: PER:	SUBARU	SUZUKI	FOR / PER
	 <p>DAT17FH T 1-3000</p>	 <p>SZ11FH 18100-19299 71001-72500</p> <p>SZ11RFH 18100-19299 19300-19617</p>	SUBARU (J) SUZUKI (J) TOYOTA (J)
FOR: PER:	SUZUKI		
	 <p>SZ12FH U 1-2000 <i>SUBARU</i></p>	 <p>SZ22FH 25001-26200</p>	 <p>SZ17RFH 25001-26200 A 6001-7000 A 301-500</p> 
FOR: PER:	TOYOTA		<p>01 COMMERCIAL GROUP GRUPPO COMMERCIALE PREISEGRUPPE GROUPE COMMERCIAL GRUPO COMMERCIAL GRUPO COMERCIAL</p>
	 <p>TOY40FH 1-5000 L 0001-1000 J 0001-2500 K 0001-2500 P 0001-250 Q 0001-2500</p>	 <p>TOY48FH 40000-49999</p>	 <p>TOY49FH K 0001-2500 P 0001-2500 L 0001-1000</p>
			<p>Flip Keys</p>  <p>www.silca.biz</p>

FOR / PER
TOYOTA (J)
TRW SIPEA (I)
VACHETTE (F)
 VALEO
VALEO (F)
 NEIMAN
 + HUF (2)

FOR: PER: TOYOTA

TOY41RFH
 G 1-2377
 P 1-2390
 X 1-2248

TOY43FH

 10001-15000
 50000-59999
 60000-69999
 25001-26200

TOY47FH
 1-13284
 T 1-13284

FOR: PER: TRW SIPEA

GT10FH
 J 3001-6732
 N 6001-7000
 V 0001-3056
 V 5001-8058
 AB 6001-6891
 3001-4000
 6001-7000

GT15RFH
 W 0001-9640

SIP22FH
 DE 1-11210

GIOBERT

FOR: PER: VACHETTE

VAC102FH
 A/Z 0/9 1-4092
 A/Z 0/9 5001-9092
 0/90/9 12345

VALEO

FOR: PER: VALEO

NE72FH

NEIMAN

VA6FH
 B1085-B9547
 12897-A9999
 ABCDEF
 1234Q5678H

01
 COMMERCIAL GROUP
 GRUPPO COMMERCIALE
 PREISEGRUPPE
 GROUPE COMMERCIAL
 GRUPO COMMERCIAL
 GRUPO COMERCIAL

Flip Keys

www.silca.biz

FOR:
PER:

YAMAHA

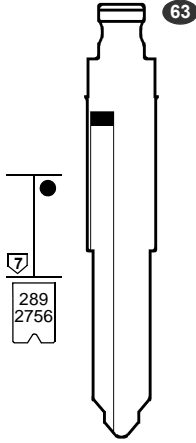

YH35RFH

A 7001-8500
 B 7001-8000
 C 7001-8000



ZADI

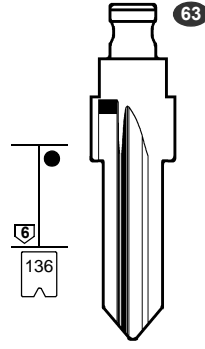

ZD24RFH

. . . . 8001-9554
 1234
 N . . . 1-700
 1001-2252
 . . . 1-700



FOR / PER

YAMAHA (J)

ZADI (I)

FOR:
PER:

FOR:
PER:

01

COMMERCIAL GROUP
 GRUPPO COMMERCIALE
 PREISEGRUPPE
 GROUPE COMMERCIAL
 GRUPO COMMERCIAL
 GRUPO COMERCIAL

Flip Keys



www.silca.biz



SILCA FLIP KEYS CHOOSE THE BEST FOR YOUR VEHICLE

**FLIP
IS CHIC**

1

**OUTSTANDING
DESIGN, PERFECT
FUNCTIONING**

2

**COMFORT OF USE:
SAFE AND BAG AND
POCKET FRIENDLY**

3

**LONG-LASTING
AND RELIABLE FLIP
MECHANISM**

4

**DISTINCTIVE,
FIRST CLASS HIGH
QUALITY**

5

**VEHICLE KEY
DUPLICATED BY A
PROFESSIONAL**

PROFESSIONAL DUPLICATION



WWW.SILCA.BIZ



New Silca TE Keys / Nuove Chiavi Silca TE / Neue TE Silca Schlüssel / Nouvelles Clés Silca TE
Nuevas Llaves Silca TE / Nuevas Chaves Silca TE



SILCA **LOOK A-LIKE KEYS**
CHOOSE THE BEST
FOR YOUR VEHICLE



WWW.SILCA.BIZ

FOR / PER
HONDA (J)
HUF (D)
NEIMAN (F)
VALEO (D) (F)
TRW SIPEA (I)
YAMAHA (J)

FOR: **HONDA**
PER:

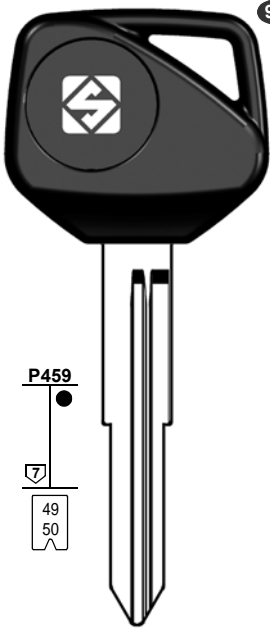

96

P459

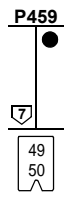

7

49
50



HON70TE
AH 1001-9282
AH 1-8154

Key with Adapter / whitout Transponder
Chiave con Adattatore / senza Transponder
Schlüssel mit Adapter / ohne Transponder
Clé avec Adaptateur / sans Transpondeur
Llaves con Adaptador / sin Transponder
Chave com Adaptador / sem Transponder

FOR: **HUF**
PER:

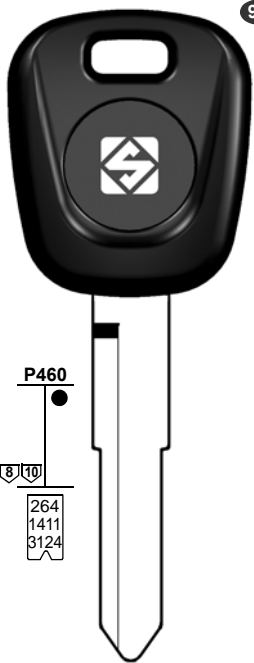

96

P460

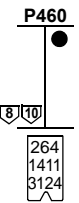

8/10

264
1411
3124



HU133RTE
. 50001-51308
U 1-2000
IP 5001-630854

Key with Adapter / whitout Transponder
Chiave con Adattatore / senza Transponder
Schlüssel mit Adapter / ohne Transponder
Clé avec Adaptateur / sans Transpondeur
Llaves con Adaptador / sin Transponder
Chave com Adaptador / sem Transponder

FOR: **NEIMAN**
PER:

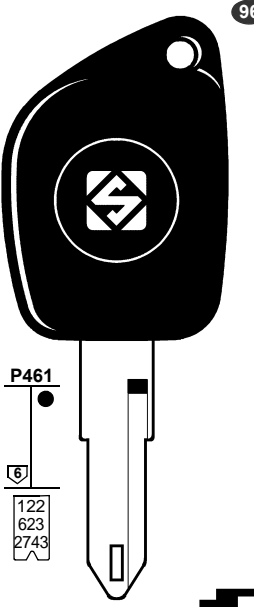

96

P461

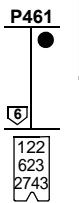

6

122
623
2743



NE72ATE
. 1/9 . . A/Z/AZ MNPRS
. 0/90/9 MNPRS
. 1/9 . . A/Z MNPRS
. 1/9 . . A/Z MNPRS
. 1/9 . . A/Z MNPRS
. 1/9 . . A/Z MNPRS
. 1/9 . . A/Z MNPRS

Key with Adapter / whitout Transponder
Chiave con Adattatore / senza Transponder
Schlüssel mit Adapter / ohne Transponder
Clé avec Adaptateur / sans Transpondeur
Llaves con Adaptador / sin Transponder
Chave com Adaptador / sem Transponder

FOR: **TRW SIPEA**
PER:

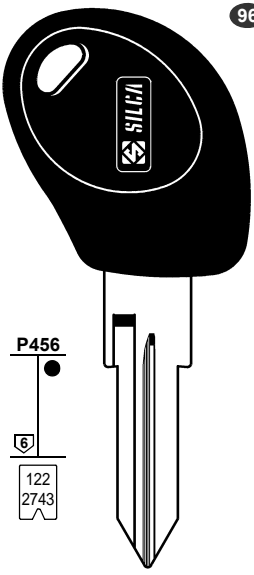

96

P456

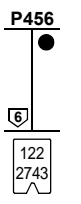

6

122
2743



GT10BTE
. 1/9 . . A/Z/AZ MNPRS
. 0/90/9 MNPRS
. 1/9 . . A/Z MNPRS
. 1/9 . . A/Z MNPRS
. 1/9 . . A/Z MNPRS
. 1/9 . . A/Z MNPRS
. 1/9 . . A/Z MNPRS
. 3001-4000
. 6001-7000

Key with Adapter / whitout Transponder
Chiave con Adattatore / senza Transponder
Schlüssel mit Adapter / ohne Transponder
Clé avec Adaptateur / sans Transpondeur
Llaves con Adaptador / sin Transponder
Chave com Adaptador / sem Transponder

FOR: **YAMAHA**
PER:

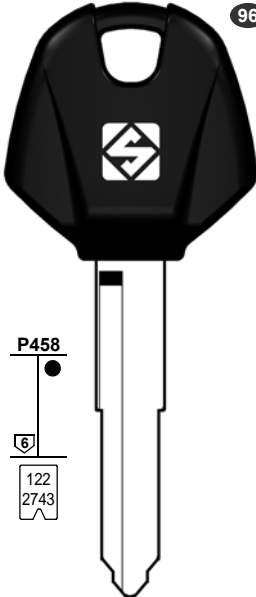

96

P458

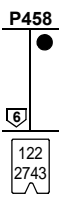

6

122
2743



YH35RATE
B 7001-8000
C 7001-8000
A 7001-8500



Key with Adapter / whitout Transponder
Chiave con Adattatore / senza Transponder
Schlüssel mit Adapter / ohne Transponder
Clé avec Adaptateur / sans Transpondeur
Llaves con Adaptador / sin Transponder
Chave com Adaptador / sem Transponder

FOR: **YAMAHA**
PER:

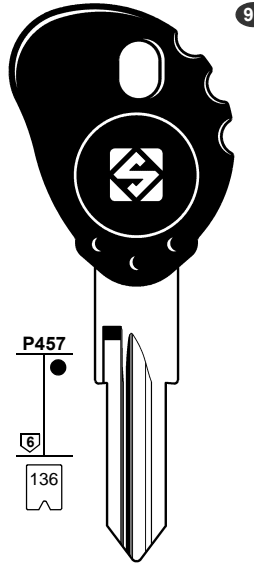

96

P457

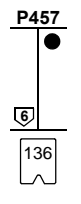

6

136



ZD24RTE
. 8001-9554
. 1-700
N 1-700
. 1-700



Key with Adapter / whitout Transponder
Chiave con Adattatore / senza Transponder
Schlüssel mit Adapter / ohne Transponder
Clé avec Adaptateur / sans Transpondeur
Llaves con Adaptador / sin Transponder
Chave com Adaptador / sem Transponder

01
COMMERCIAL GROUP
GRUPPO COMMERCIALE
PREISEGRUPPE
GROUPE COMMERCIAL
GRUPO COMMERCIAL
GRUPO COMERCIAL

www.silca.biz



**NOW 100% COMPATIBLE
WITH GTI**

Silca Keyless Keys are now compatible with GTI

🇬🇧 GTI-COMPATIBLE SILCA KEYLESS KEYS

Silca Keyless Series is now compatible with Glass Transponder Innovation, the first multifunctional, programmable glass transponder worldwide. The new key kit includes: plastic key, transponder adapter, metallic blade and metallic steering. Silca Keyless solution does not include remote control functions. Single easy-to-display packaging.

Available for the most popular BMW®, Volvo® and Fiat® models.

🇩🇪 SILCA KEYLESS SCHLÜSSEL KOMPATIBEL MIT GTI

Die Serie Silca Keyless ist jetzt kompatibel mit Glas Transponder Innovation, der erste multifunktionale, programmierbare Glas-Transponder weltweit. Das Set des neuen Schlüssels enthält: Plastik-Schlüssel, Transponder Adapter, Metallschaft und Metallring. Die Silca Keyless Lösung bietet nicht die Funktionalität der Fernbedienung. Einzelverpackung für den Aufsteller.

Für die meistverkauften und bekanntesten BMW®, Volvo® und Fiat® Modelle verfügbar.

🇪🇸 LLAVES SILCA KEYLESS COMPATIBLES CON GTI

La serie Silca Keyless está ahora compatible con Glass Transponder Innovation, el primer transponder de cristal multifunción y programable en el mundo. El kit de esta nueva llave incluye: llave de plástico, adaptador transponder, espadín y anilla metálica. La solución Silca Keyless no funciona como mando original. Blister individual para expositor.

Disponibile para los modelos BMW®, Volvo® y Fiat® más populares.

🇵🇹 CHAVES SILCA KEYLESS COMPATÍVEIS COM GTI

A série Silca Keyless agora é compatível com Glass Transponder Innovation, o primeiro transponder em vidro multi-função e programável no mundo. O kit da nova chave inclui: chave em plástico, adaptador transponder, perfil metálico e anel metálico. A solução Silca Keyless não funciona como um controle remoto. Embalagem individual para uso expositor.

Disponível para os modelos BMW®, Volvo® e Fiat® mais populares.

🇮🇹 CHIAVI SILCA KEYLESS COMPATIBILI CON GTI

La serie Silca Keyless è ora compatibile con Glass Transponder Innovation, il primo transponder in vetro al mondo multifunzionale e programmabile. Il kit della nuova chiave comprende: chiave in plastica, adattatore transponder, canna metallica e anello metallico. Silca Keyless non ha funzioni di telecomando. Confezione singola ottimizzata per espositore.

Disponibile per i modelli BMW®, Volvo® e Fiat® più diffusi.

🇫🇷 CLÉS SILCA KEYLESS COMPATIBLES AVEC GTI

La série Silca Keyless est maintenant compatible avec Glass Transponder Innovation, le premier transpondeur en verre au monde, multifonctions et programmable. Le kit de cette nouvelle clé comprend: clé en plastique, adaptateur transpondeur, insert en métal et anneau en métal. La solution Silca Keyless ne fonctionne toutefois pas comme une télécommande. Emballage individuel pour affichage.

Disponibile pour les modèles BMW®, Volvo® et Fiat® les plus populaires.



Volvo® kit code: HU137TEK		
Model	From	To
S80	2008	2011
V70	2008	-
XC70	2008	2011
Fiat® kit code: SIP22TEK		
Model	From	To
Croma	2005	2010

BMW® kit code: HU92RTEK		
Model	From	To
Series 1	2004	2011
Series 3	2005	2011
Series 5	2003	2010
Series 6	2004	2011
X5	2004	2011
Z4	2006	2011

BMW®, Volvo® and Fiat® are Registered Trademarks.



Plastic Key with transponder adapter

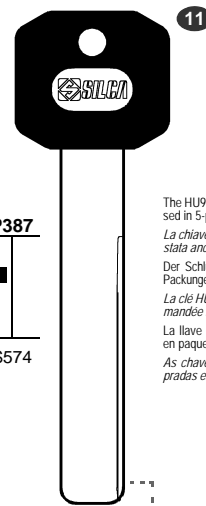

HU92RKP

Metallic blade with plastic head



HU92RTEK ⁶⁷⁵
Code for BMW® Kit

The HU92RKP key can be also purchased in 5-piece packages.
 La chiave HU92RKP può essere acquistata anche in confezioni da 5 pezzi.
 Der Schlüssel HU92RKP kann auch in Packungen mit 5 Stücke gekauft werden.
 La clé HU92RKP peut même être commandée sous confection de 5 pcs.
 La llave HU92RKP se puede comprar en paquetes de 5 piezas.
 As chave HU92RKP podem ser compradas em pacotes de 5 unidades.

PACKAGE KIT - Code HU92RTEK



1 SINGLE PACKAGE



2 PLASTIC KEY



3 METALLIC BLADE WITH PLASTIC HEAD



4 STEELRING

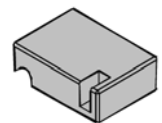

5 TRANSPONDER ADAPTER



Plastic Key with transponder adapter

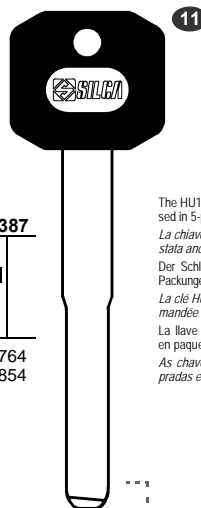

HU137KP

Metallic blade with plastic head



HU137TEK ⁶⁷⁵
Code for VOLVO Kit



The HU137KP key can be also purchased in 5-piece packages.
 La chiave HU137KP può essere acquistata anche in confezioni da 5 pezzi.
 Der Schlüssel HU137KP kann auch in Packungen mit 5 Stücke gekauft werden.
 La clé HU137KP peut même être commandée sous confection de 5 pcs.
 La llave HU137KP se puede comprar en paquetes de 5 piezas.
 As chave HU137KP podem ser compradas em pacotes de 5 unidades.

PACKAGE KIT - Code HU137TEK



1 SINGLE PACKAGE



2 PLASTIC KEY



3 METALLIC BLADE WITH PLASTIC HEAD



4 STEELRING

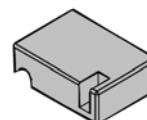

5 TRANSPONDER ADAPTER

01

COMMERCIAL GROUP
GRUPPO COMMERCIALE
PREISEGRUPPE
GRUPE COMMERCIAL
GRUPO COMMERCIAL
GRUPO COMERCIAL

www.silca.biz



Plastic Key with transponder adapter

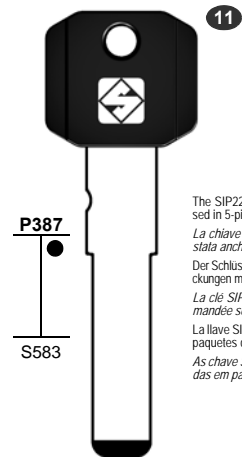

P387

S583

SIP22KP

Metallic blade with plastic head



SIP22TEK (675)
Code for FIAT Kit

The SIP22KP key can be also purchased in 5-piece packages.
La chiave SIP22KP può essere acquistata anche in confezioni da 5 pezzi.
Der Schlüssel SIP22KP kann auch in Packungen mit 5 Stücke gekauft werden.
La clé SIP22KP peut même être commandée sous confection de 5 pcs.
La llave SIP22KP se puede comprar en paquetes de 5 piezas.
As chave SIP22KP podem ser compradas em pacotes de 5 unidades.

PACKAGE KIT - Code SIP22TEK



1 SINGLE PACKAGE



2 PLASTIC KEY



3 METALLIC BLADE WITH PLASTIC HEAD



4 STEELRING

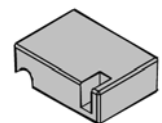















5 TRANSPONDER ADAPTER

01

COMMERCIAL GROUP
GRUPPO COMMERCIALE
PREISEGRUPPE
GROUPE COMMERCIAL
GRUPO COMMERCIAL
GRUPO COMERCIAL















www.silca.biz

1	2	2a	3	3a	3b	E1+E2		6	42+71	72	43 44a	12	15
						GTI Compatibility							
CAR MAKE/MODEL 	FROM 1995	TO 2014	SILCA REF.  Ref.	SILCA REF.  "TE" Silca Ref.	 SILCA REF.  "Flip Keys" Silca Ref.	COPY 	GEN. 	TRANSP. TYPE 	ID  FAST COPY PLUS RW4 PLUS FAST COPY/RW4	COPY  FAST COPY PLUS RW4 PLUS	COPY  FAST COPY RW4	STP 	
ABARTH®													
500	2008		SIP22MH	SIP22TE	SIP22FH*	Y		PH/CR2	46	Y	P-BOX		
GRANDE PUNTO	2007	2010	SIP22MH	SIP22TE	SIP22FH*	Y		PH/CR2	46	Y	P-BOX		
PUNTO	2012		SIP22MH	SIP22TE	SIP22FH*	Y		PH/CR2	46	Y	P-BOX		
PUNTO EVO	2010	2012	SIP22MH	SIP22TE	SIP22FH*	Y		PH/CR2	46	Y	P-BOX		
ACURA®													
CL	1998	2003	HON58RT5		HON58RFH**			MEG	13	Y	Y		
CSX	2006	2011	HON66MH		HON66FH**	Y	Y	PH/CR2	46	Y	P-BOX		
EL	2001	2002	HON58RT5		HON58RFH**			MEG	13	Y	Y		
EL	2003	2005	HON66T5		HON66FH**			MEG	13	Y	Y		
INTEGRA	2000	2001	HON58RT5		HON58RFH**			MEG	13	Y	Y		
MDX	2001	2006	HON58RT5		HON58RFH**			MEG	13	Y	Y		
MDX	2007		HON66MH		HON66FH*	Y	Y	PH/CR2	46	Y	P-BOX		
NSX	1997	2005	HON58RT5		HON58RFH*			MEG	13	Y	Y	(MEG)	
RDX	2007		HON66MH		HON66FH*	Y	Y	PH/CR2	46	Y	P-BOX		
RL	1996	2004	HON58RT5		HON58RFH*			MEG	13	Y	Y	(MEG)	
RL	2005	2010	HON58RMH		HON58RFH*	Y	Y	PH/CR2	46	Y	P-BOX		
RSX	2002	2006	HON58RT5		HON58RFH*			MEG	13	Y	Y		
TL	1999	2003	HON58RT5		HON58RFH*			MEG	13	Y	Y		
TL	2004	2006	HON58RMH		HON58RFH*	Y	Y	PH/CR2	46	Y	P-BOX		
TL	2007		HON66MH		HON66FH*	Y	Y	PH/CR2	46	Y	P-BOX		
TSX	2004	2007	HON58RMH		HON58RFH*	Y	Y	PH/CR2	46	Y	P-BOX		
TSX	2007		HON66MH		HON66FH*	Y	Y	PH/CR2	46	Y	P-BOX		
ZDX	2010	2012	HON66MH		HON66FH*	Y	Y	PH/CR2	46	Y	P-BOX		
ALFA ROMEO®													
145	1994	1995	GT15RAP		GT15RFH*								
145	1995	1998	GT15RT2		GT15RFH*			PH	33	Y	Y	B-F	S1
146	1995	1998	GT15RT2		GT15RFH*			PH	33	Y	Y	B-F	S1
155	1995	1998	GT15RT2		GT15RFH*			PH	33	Y	Y	B-F	S1
156	2001	2003	SIP22MH	SIP22TE	SIP22FH*	Y		PH/CR2	46	Y	P-BOX		
166	2004	2008	SIP22MH	SIP22TE	SIP22FH*	Y		PH/CR2	46	Y	P-BOX		
156 SPORT WAGON	2001	2007	SIP22MH	SIP22TE	SIP22FH*	Y		PH/CR2	46	Y	P-BOX		
GTV	1995	1998	GT15RT2		GT15RFH*			PH	33	Y	Y	B-F	S1
GIULIETTA	2010		SIP36MH	SIP22TE	SIP22FH*	Y		PH/CR2	46	Y	P-BOX		
MITO	2008		SIP22MH	SIP22TE	SIP22FH*	Y		PH/CR2	46	Y	P-BOX		
SPIDER	1995	1998	GT15RT2		GT15RFH*			PH	33	Y	Y	B-F	S1
SOME MODELS	1995		GT15RMH		GT15RFH*								

* Blade for "Flip" Key plastic head













See info on the uses of the keys on Silca Electronic Keys Catalogue



1	2	2a	3	3a	3b	E1+E2		6	42+71	72	43 44a	12	15
						GTI Compatibility							
CAR MAKE/MODEL 	FROM 1995	TO 2014	SILCA REF.  Ref.	SILCA REF.  "TE" Silca Ref.	 SILCA REF.  "Flip Keys" Silca Ref.	COPY 	GEN. 	TRANSP. TYPE 	ID  FAST COPY PLUS RW4 PLUS FAST COPY/RW4	COPY  FAST COPY PLUS RW4 PLUS	COPY  FAST COPY RW4	STP  	
AUDI®													
A2	2000	2005	HU66AT6		HU66FH*			MEG/CR	48				
A3	1996	1997	HU66AT5		HU66FH*			MEG	13	Y	Y	MEG	
A3	1997	2004	HU66AT6		HU66FH*			MEG/CR	48				
A4	1996	1997	HU66AT5		HU66FH*			MEG	13	Y	Y	MEG	
A4	1997	2004	HU66AT6		HU66FH*			MEG/CR	48				
A6	1996	1997	HU66AT5		HU66FH*			MEG	13	Y	Y	MEG	
A6	1997	2004	HU66AT6		HU66FH*			MEG/CR	48				
A8	1996	1997	HU66AT5		HU66FH*			MEG	13	Y	Y	MEG	
A8	1997	2004	HU66AT6		HU66FH*			MEG/CR	48				
A8	2004		HU66MH	HU66TE	HU66FH*	Y		PH/CR2	46	Y	P-BOX		
ALLROAD	2000	2005	HU66AT6		HU66FH*			MEG/CR	48				
CABRIO	1996	1997	HU66AT5		HU66FH*			MEG	13	Y	Y	MEG	
CABRIO	1997		HU66AT6		HU66FH*			MEG/CR	48				
COUPE'	1996	1997	HU66AT5		HU66FH*			MEG	13	Y	Y	MEG	
COUPE'	1997		HU66AT6		HU66FH*			MEG/CR	48				
COUPE' S2	1996	1997	HU66AT5		HU66FH*			MEG	13	Y	Y	MEG	
COUPE' S2	1997		HU66AT6		HU66FH*			MEG/CR	48				
S3	2001	2004	HU66AT6		HU66FH*			MEG/CR	48				
S4	2002	2005	HU66T6		HU66FH*			MEG/CR	48				
S6	1996	1997	HU66AT5		HU66FH*			MEG	13	Y	Y	MEG	
S6	1997		HU66AT6		HU66FH*			MEG/CR	48				
S8	1998		HU66AT6		HU66FH*			MEG/CR	48				
TT	1998	2004	HU66AT6		HU66FH*			MEG/CR	48				
BUICK®													
ALLURE	2010		HU100MH	HU100TE	HU100FH*	Y		PH/CR2	46	Y	P-BOX		
LACROSSE	2010		HU100MH	HU100TE	HU100FH*	Y		PH/CR2	46	Y	P-BOX		
REGAL	2011		HU100MH	HU100TE	HU100FH*	Y		PH/CR2	46	Y	P-BOX		
VERANO	2012		HU100MH	HU100TE	HU100FH*	Y		PH/CR2	46	Y	P-BOX		
CADILLAC®													
SRX	2010		HU100MH	HU100TE	HU100FH*	Y		PH/CR2	46	Y	P-BOX		
CHEVROLET S.AMERICA®													
AGILE	2009		HU100MH	HU100TE	HU100FH*	Y		PH/CR2	46	Y	P-BOX		
OMEGA	1995	1998	HU43T2		HU43FH*			PH	33	Y	Y	S-O	
CHEVROLET USA®													
AVEO	2004	2010	DWO4RAP		DWO4RFH*								
AVEO	2004	2010	DWO4RT5		DWO4RFH*			MEG	13	Y	Y	M-V	

Car Keys Guide / Guida Chiavi Auto / Führer für Autoschlüssel / Guide Clés pour Voitures
 Guía Llaves para Coches / Guia Chaves para Carros

















New Updates









1	2	2a	3	3a	3b	E1+E2		6	42+71	72	43 44a	12	15
						GTI Compatibility							
CAR MAKE/MODEL 	FROM 1995	TO 2014	SILCA REF.  Ref.	SILCA REF.  "TE" Silca Ref.	SILCA REF.  "Flip Keys" Silca Ref.	COPY 	GEN. 	TRANSP. TYPE 	ID  FAST COPY PLUS RW4 PLUS FAST COPY/RW4	COPY  FAST COPY PLUS RW4 PLUS	COPY  FAST COPY RW4	STP 	
CHEVROLET USA®													
CAMARO	2010		HU100MH	HU100TE	HU100FH*	Y		PH/CR2	46	Y	P-BOX		
CAPTIVA SPORT	2012		DWO5MH		DWO5FH*	Y		PH/CR2	46	Y	P-BOX		
CRUZE	2011		HU100MH	HU100TE	HU100FH*	Y		PH/CR2	46	Y	P-BOX		
EPICA	2004	2007	DWO5T5		DWO5FH*			MEG	13	Y	Y		
EQUINOX	2010		HU100MH	HU100TE	HU100FH*	Y		PH/CR2	46	Y	P-BOX		
MALIBU	2013		HU100MH	HU100TE	HU100FH*	Y		PH/CR2	46	Y	P-BOX		
OPTRA	2004	2007	DWO4RAP		DWO4RFH*								
ORLANDO	2012		HU100MH	HU100TE	HU100FH*	Y		PH/CR2	46	Y	P-BOX		
SONIC	2012		HU100MH	HU100TE	HU100FH*	Y		PH/CR2	46	Y	P-BOX		
VOLT	2011		HU100MH	HU100TE	HU100FH*	Y		PH/CR2	46	Y	P-BOX		
CHEVROLET-DAEWOO®													
AVEO	2006	2011	DWO4RT6		DWO4RFH*			MEG/CR	48-A				
AVEO	2011		HU100MH	HU100TE	HU100FH*	Y		PH/CR2	46	Y	P-BOX		
CAPTIVA	2006		DWO5MH		DWO5FH*	Y		PH/CR2	46	Y	P-BOX		
CRUZE	2009		HU100MH	HU100TE	HU100FH*	Y		PH/CR2	46	Y	P-BOX		
EPICA	2006		DWO5MH		DWO5FH*	Y	Y	TEX/CR	60	Y	P-BOX		
EPICA	2008		DWO5MH		DWO5FH*	Y		TEX/CR	XX	Y	P-BOX		
EVANDA	2003	2006	DWO5MH		DWO5FH*	Y	Y	TEX/CR	60	Y	P-BOX		
KALOS	2002	2006	DWO4RT6		DWO4RFH*			MEG/CR	48-A				
LACETTI	2002	2004	DWO4RT6		DWO4RFH*			MEG/CR	48-A				
LACETTI	2004	2009	DWO4RMH		DWO4RFH*	Y	Y	TEX/CR	60	Y	P-BOX		
LEGANZA	1997	2000	DWO5AP		DWO5FH*								
LEGANZA	1997	2000	DWO5T5		DWO5FH*			MEG	13	Y	Y	M-V	
LEGANZA	2000	2008	DWO5T6		DWO5FH*			MEG/CR	48-A				
LEGANZA (USA)	2001	2004	DWO5T5		DWO5FH*			MEG	13	Y	Y		
MALIBU	2012		HU100MH	HU100TE	HU100FH*	Y		PH/CR2	46	Y	P-BOX		
NUBIRA	1997	2000	DWO4R		DWO4RFH*								
NUBIRA	1997	2000	DWO4RAP		DWO4RFH*								
NUBIRA	1997	2000	DWO4RT5		DWO4RFH*			MEG	13	Y	Y	M-V	
NUBIRA	2000	2002	DWO4RT6		DWO4RFH*			MEG/CR	48-A				
NUBIRA SW	2004	2009	DWO4RMH		DWO4RFH*	Y	Y	TEX/CR	60	Y	P-BOX		
ORLANDO	2011		HU100MH	HU100TE	HU100FH*	Y		PH/CR2	46	Y	P-BOX		
TACUMA	2000	2002	DWO4R		DWO4RFH*								
TACUMA	2000	2008	DWO4RT6		DWO4RFH*			MEG/CR	48-A				
TRAX	2013		HU100MH	HU100TE	HU100FH*	Y		PH/CR2	46	Y	P-BOX		
VOLT	2012		HU100MH	HU100TE	HU100FH*	Y		PH/CR2	46	Y	P-BOX		

* Blade for "Flip" Key plastic head

See info on the uses of the keys on Silca Electronic Keys Catalogue



















1	2	2a	3	3a	3b	E1+E2		6	42+71	72	43 44a	12	15	
						GTI Compatibility								
CAR MAKE/MODEL 	FROM 1995 	TO 2014 	SILCA REF.  Ref.	SILCA REF.  "TE" Silca Ref.	 SILCA REF.  "Flip Keys" Silca Ref.	COPY 	GEN. 	TRANSP. TYPE 	ID  FAST COPY PLUS RW4 PLUS FAST COPY/RW4	COPY  FAST COPY PLUS RW4 PLUS	COPY  FAST COPY RW4	STP   		
CHRYSLER®														
200	2011		CY24MH		CY24FH**	Y	Y	PH/CR2	46	Y	P-BOX			
300	1998	2004	CY24MH		CY24FH**	Y	Y	TEX/CR	64	Y	P-BOX			
300	2005	2008	CY24MH		CY24FH*	Y	Y	PH/CR2	46	Y	P-BOX			
ASPEN	2007	2009	CY24MH		CY24FH*	Y	Y	PH/CR2	46	Y	P-BOX			
CIRRUS	1999	2000	CY24MH		CY24FH*	Y	Y	TEX/CR	64	Y	P-BOX			
CIRRUS CONVERTIBLE	2001	2002	CY24MH		CY24FH*	Y	Y	TEX/CR	64	Y	P-BOX			
CIRRUS SEDAN	2001	2002	CY24MH		CY24FH*	Y	Y	TEX/CR	64	Y	P-BOX			
CONCORDE	1998	2004	CY24MH		CY24FH*	Y	Y	TEX/CR	64	Y	P-BOX			
LHS	1999	2001	CY24MH		CY24FH*	Y	Y	TEX/CR	64	Y	P-BOX			
NEON	2000	2005	CY24MH		CY24FH*	Y	Y	TEX/CR	64	Y	P-BOX			
NEW YORKER	1998	2001	CY24MH		CY24FH*	Y	Y	TEX/CR	64	Y	P-BOX			
PACIFICA	2004	2008	CY24MH		CY24FH*	Y	Y	PH/CR2	46	Y	P-BOX			
PT CRUISER	2001	2005	CY24MH		CY24FH*	Y	Y	TEX/CR	64	Y	P-BOX			
PT CRUISER	2006	2011	CY24MH		CY24FH*	Y	Y	PH/CR2	46	Y	P-BOX			
PT CRUISER LE	2001	2005	CY24MH		CY24FH*	Y	Y	TEX/CR	64	Y	P-BOX			
SEBRING	2007	2011	CY24MH		CY24FH*	Y	Y	PH/CR2	46	Y	P-BOX			
SEBRING CONVERT	2001	2006	CY24MH		CY24FH*	Y	Y	TEX/CR	64	Y	P-BOX			
SEBRING CONVERT	2007	2011	CY24MH		CY24FH*	Y	Y	PH/CR2	46	Y	P-BOX			
SEBRING SEDAN	1999	2006	CY24MH		CY24FH*	Y	Y	TEX/CR	64	Y	P-BOX			
STRATUS	1998	2006	CY24MH		CY24FH*	Y	Y	TEX/CR	64	Y	P-BOX			
TOWN & COUNTRY	2001	2004	CY24MH		CY24FH*	Y	Y	TEX/CR	64	Y	P-BOX			
TOWN & COUNTRY	2004	2007	CY24MH		CY24FH*	Y	Y	PH/CR2	46	Y	P-BOX			
VISION	1998		CY24MH		CY24FH*	Y	Y	TEX/CR	64	Y	P-BOX			
VOYAGER	1998	2003	CY24MH		CY24FH*	Y	Y	TEX/CR	64	Y	P-BOX			
VOYAGER	2004	2007	CY24MH		CY24FH*	Y	Y	PH/CR2	46	Y	P-BOX			
CITROËN®														
BERLINGO	2002		VA6MH		VA6FH*	Y	Y	PH/CR2	46	Y	P-BOX			
C1	2004		VA6MH		VA6FH*	Y	Y	TEX/CR	70	Y	P-BOX			
C2	2003		VA6MH		VA6FH*	Y	Y	PH/CR2	46	Y	P-BOX			
C3	2002		VA6MH		VA6FH*	Y	Y	PH/CR2	46	Y	P-BOX			
C3 PICASSO	2008		VA6MH		VA6FH*	Y	Y	PH/CR2	46	Y	P-BOX			
C4	2005		VA6MH		VA6FH*	Y	Y	PH/CR2	46	Y	P-BOX			
C4 PICASSO	2006		HU83MH	HU83TE	HU83FH*	Y	Y	PH/CR2	46	Y	P-BOX			
C5	2006	2008	VA6MH		VA6FH*	Y	Y	PH/CR2	46	Y	P-BOX			
C5	2008		HU83MH	HU83TE	HU83FH*	Y	Y	PH/CR2	46	Y	P-BOX			
C6	2006		VA6MH		VA6FH*	Y	Y	PH/CR2	46	Y	P-BOX			

1	2	2a	3	3a	3b	E1+E2		6	42+71	72	43 44a	12	15
						GT1 Compatibility							
CAR MAKE/MODEL	FROM 1995	TO 2014	SILCA REF.  Ref.	SILCA REF.  "TE" Silca Ref.	 SILCA REF.  "Flip Keys" Silca Ref.	COPY	GEN.	TRANSP. TYPE	ID  FAST COPY PLUS RW4 PLUS FAST COPY/RW4	COPY  FAST COPY PLUS RW4 PLUS	COPY  FAST COPY RW4	STP 	
CITROËN®													
C8	2002		HU83MH	HU83TE	HU83FH*	Y	Y	PH/CR2	46	Y	P-BOX		
C-CROSSER	2007		MIT11RMH	MIT11RTE	MIT11RFH*	Y	Y	PH/CR2	46	Y	P-BOX		
C-ZERO	2011		MIT11RMH	MIT11RTE	MIT11RFH*	Y	Y	PH/CR2	46	Y	P-BOX		
DISPATCH	2007		HU83MH	HU83TE	HU83FH*	Y	Y	PH/CR2	46	Y	P-BOX		
DS3	2010		VA6MH		VA6FH*	Y		PH/CR2	46	Y	P-BOX		
DS4	2011		VA6MH		VA6FH*	Y		PH/CR2	46	Y	P-BOX		
JUMPER	1996	2001	GT10BT5		GT10FH*			MEG	13	Y	Y	MEG	S1
JUMPER	2006		SIP36MH	SIP22TE	SIP22FH*	Y	Y	PH/CR2	46	Y	P-BOX		
JUMPY	2007		HU83MH	HU83TE	HU83FH*	Y	Y	PH/CR2	46	Y	P-BOX		
NEMO	2008		SIP22MH	SIP22TE	SIP22FH*	Y		PH/CR2	46	Y	P-BOX		
RELAY	1996	2001	GT10BT5		GT10FH*			MEG	13	Y	Y	MEG	S1
RELAY	2006		SIP22MH	SIP22TE	SIP22FH*	Y		PH/CR2	46	Y	P-BOX		
DAIHATSU®													
CHARADE	1998	2004	TOY41RMH	TOY41RTE	TOY41RFH*	Y	Y	TEXAS	4C	Y	P-BOX		
CHARADE	2011		TOY47MH	TOY47TE	TOY47FH*	Y	Y	TEX/CR	70	Y	P-BOX		
COPEN	2002		TOY41RMH	TOY41RTE	TOY41RFH*	Y	Y	TEXAS	4C	Y	P-BOX		
CUORE	1998	2006	TOY41RMH	TOY41RTE	TOY41RFH*	Y	Y	TEXAS	4C	Y	P-BOX		
CUORE	2007		TOY41RMH	TOY41RTE	TOY41RFH*	Y		TEX/CR	67	Y	P-BOX		
FEROZA	1995	1998	TOY41RMH	TOY41RTE	TOY41RFH*	Y	Y	TEXAS	4C	Y	P-BOX		
MATERIA	2006		TOY41RMH	TOY41RTE	TOY41RFH*	Y		TEX/CR	67	Y	P-BOX		
SIRION	1998	2004	TOY41RMH	TOY41RTE	TOY41RFH*	Y	Y	TEXAS	4C	Y	P-BOX		
SIRION	2005		TOY41RMH	TOY41RTE	TOY41RFH*	Y		TEX/CR	67	Y	P-BOX		
TERIOS	1997	2005	TOY41RMH	TOY41RTE	TOY41RFH*	Y	Y	TEXAS	4C	Y	P-BOX		
TERIOS	2006		TOY41RMH	TOY41RTE	TOY41RFH*	Y		TEX/CR	67	Y	P-BOX		
TREVIS	2007		TOY41RMH	TOY41RTE	TOY41RFH*	Y		TEX/CR	67	Y	P-BOX		
YRV	2000	2005	TOY41RMH	TOY41RTE	TOY41RFH*	Y	Y	TEXAS	4C	Y	P-BOX		
DODGE®													
AVENGER	2008		CY24MH		CY24FH*	Y	Y	PH/CR2	46	Y	P-BOX		
CALIBER	2007	2012	CY24MH		CY24FH*	Y	Y	PH/CR2	46	Y	P-BOX		
CARAVAN	2001	2003	CY24MH		CY24FH*	Y	Y	TEX/CR	64	Y	P-BOX		
CARAVAN	2004	2007	CY24MH		CY24FH*	Y	Y	PH/CR2	46	Y	P-BOX		
CHARGER	2005	2008	CY24MH		CY24FH*	Y	Y	PH/CR2	46	Y	P-BOX		
DAKOTA	2001	2004	CY24MH		CY24FH*	Y	Y	TEX/CR	64	Y	P-BOX		
DAKOTA	2005	2011	CY24MH		CY24FH*	Y	Y	PH/CR2	46	Y	P-BOX		
DURANGO	2001	2004	CY24MH		CY24FH*	Y	Y	TEX/CR	64	Y	P-BOX		
DURANGO	2005	2009	CY24MH		CY24FH*	Y	Y	PH/CR2	46	Y	P-BOX		
INTREPID	1998	2004	CY24MH		CY24FH*	Y	Y	TEX/CR	64	Y	P-BOX		

* Blade for "Flip" Key plastic head















See info on the uses of the keys on Silca Electronic Keys Catalogue

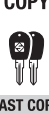

1	2	2a	3	3a	3b	E1+E2		6	42+71	72	43 44a	12	15	
						GTI Compatibility								
CAR MAKE/MODEL 	FROM 1995 	TO 2014 	SILCA REF.  Ref.	SILCA REF.  "TE" Silca Ref.	 SILCA REF.  "Flip Keys" Silca Ref.	COPY 	GEN. 	TRANSP. TYPE 	ID  FAST COPY PLUS RW4 PLUS FAST COPY/RW4	COPY  FAST COPY PLUS RW4 PLUS	COPY  FAST COPY RW4	STP  		
DODGE®														
INTREPID SEDAN, ES	2001	2004	CY24MH		CY24FH*	Y	Y	TEX/CR	64	Y	P-BOX			
MAGNUM	2005	2008	CY24MH		CY24FH*	Y	Y	PH/CR2	46	Y	P-BOX			
NEON	2000	2005	CY24MH		CY24FH*	Y	Y	TEX/CR	64	Y	P-BOX			
NITRO	2007	2012	CY24MH		CY24FH*	Y	Y	PH/CR2	46	Y	P-BOX			
RAM	2002	2005	CY24MH		CY24FH*	Y	Y	TEX/CR	64	Y	P-BOX			
RAM	2006	2011	CY24MH		CY24FH*	Y	Y	PH/CR2	46	Y	P-BOX			
STRATUS SEDAN	1998	2006	CY24MH		CY24FH*	Y	Y	TEX/CR	64	Y	P-BOX			
EAGLE®														
VISION	1998		CY24MH		CY24FH*	Y	Y	TEX/CR	64	Y	P-BOX			
FIAT®														
500	2007		SIP22MH	SIP22TE	SIP22FH*	Y		PH/CR2	46	Y	P-BOX			
500L	2012		SIP22MH	SIP22TE	SIP22FH*	Y		PH/CR2	46	Y	P-BOX			
BARCETTA	1995	2002	GT15RAT5		GT15RFH*			MEG	13	Y	Y	MEG	S1	
BRAVA	1995	1996	GT15RBT5		GT15RFH*			MEG	13	Y	Y	MEG	S1	
BRAVA	1997	2001	GT15RCT5		GT15RFH*			TEMIC	11	Y	Y	T-F	S1	
BRAVO	1995	1996	GT15RBT5		GT15RFH*			MEG	13	Y	Y	MEG	S1	
BRAVO	1997	2001	GT15RCT5		GT15RFH*			TEMIC	11	Y	Y	T-F	S1	
BRAVO	2007		SIP22MH	SIP22TE	SIP22FH*	Y		PH/CR2	46	Y	P-BOX			
CINQUECENTO	1995	1996	GT10BT5		GT10FH*			MEG	13	Y	Y	MEG	S1	
CINQUECENTO	1997	1998	GT15RBT5		GT15RFH*			MEG	13	Y	Y	MEG	S1	
COUPÈ	1995	2000	GT15RAT5		GT15RFH*			PH	33	Y	Y	B-F	S1	
CROMA	1995	1997	GT10BT5		GT10FH*			PH	33	Y	Y	B-F	S1	
DOBLÒ	2006		SIP22MH	SIP22TE	SIP22FH*	Y		PH/CR2	46	Y	P-BOX			
DUCATO	1996	2001	GT10BT5		GT10FH*			MEG	13	Y	Y	MEG	S1	
DUCATO	2006		SIP36MH	SIP22TE	SIP22FH*	Y		PH/CR2	46	Y	P-BOX			
FIORINO	1995	2002	GT10BT5		GT10FH*			TEMIC	11	Y	Y	T-F	S1	
FIORINO	2007		SIP22MH	SIP22TE	SIP22FH*	Y		PH/CR2	46	Y	P-BOX			
GRANDE PUNTO	2005		SIP22MH	SIP22TE	SIP22FH*	Y		PH/CR2	46	Y	P-BOX			
IDEA	2009		SIP22MH	SIP22TE	SIP22FH*	Y		PH/CR2	46	Y	P-BOX			
MAREA	1996	2002	GT15RCT5		GT15RFH*			TEMIC	11	Y	Y	T-F	S1	
MARENGO	1996	2001	GT15RBT5		GT15RFH*			MEG	13	Y	Y	MEG	S1	
PALIO	1996	2001	GT15RCT5		GT15RFH*			TEMIC	11	Y	Y	T-F	S1	
PALIO (S.AMERICA)	1996	2001	GT15RCP		GT15RFH*									
PANDA	1995	2002	GT10BT5		GT10FH*			MEG	13	Y	Y	MEG	S1	
PANDA	2002		SIP22MH	SIP22TE	SIP22FH*	Y		PH/CR2	46	Y	P-BOX			
PUNTO	1995	1999	GT15RAT5		GT15RFH*			MEG	13	Y	Y	MEG	S1	
PUNTO	2012		SIP22MH	SIP22TE	SIP22FH*	Y		PH/CR2	46	Y	P-BOX			

* Blade for "Flip" Key plastic head

















See info on the uses of the keys on Silca Electronic Keys Catalogue 

















1	2	2a	3	3a	3b	E1+E2		6	42+71	72	43 44a	12	15
CAR MAKE/MODEL 	FROM	TO	SILCA REF. 	SILCA REF. 	 SILCA REF. 	COPY	GEN.	TRANSP. TYPE 	ID 	COPY 	COPY 	STP 	
	1995	2014	Ref.	"TE" Silca Ref.	"Flip Keys" Silca Ref.				FAST COPY PLUS RW4 PLUS FAST COPY/RW4	FAST COPY PLUS RW4 PLUS	FAST COPY RW4		
FIAT®													
PUNTO EVO	2009	2012	SIP22MH	SIP22TE	SIP22FH*	Y		PH/CR2	46	Y	P-BOX		
QUBO	2008		SIP22MH	SIP22TE	SIP22FH*	Y		PH/CR2	46	Y	P-BOX		
SCUDO	2007		HU83MH	HU83TE	HU83FH*	Y	Y	PH/CR2	46	Y	P-BOX		
SEDICI	2006		HU133RMH	HU133RTE	HU133RFH*	Y	Y	PH/CR2	46	Y	P-BOX		
SEDICI DIESEL	2006		HU133RT12		HU133RFH*			PH/CR	40				
SEICENTO	1997	2000	GT15RBT5		GT15RFH*			MEG	13	Y	Y	MEG	S1
SOME MODELS	1995		GT15RMH		GT15RFH*								
TEMPRA	1995	1996	GT15RBT5		GT15RFH*			MEG	13	Y	Y	MEG	S1
ULYSSE	2002	2011	HU83MH	HU83TE	HU83FH*	Y	Y	PH/CR2	46	Y	P-BOX		
FORD AUS®													
BF FALCON	2005		HU101MH	HU101TE	HU101FH*	Y	Y	TEX/CR2	6F	Y	P-BOX		
ESCAPE	2005		FO38RMH	FO38RTE	FO38RFH*	Y	Y	TEX/CR	63	Y	P-BOX		
EXPLORER	1998	2000	FO38RMH	FO38RTE	FO38RFH*	Y	Y	TEXAS	4C	Y	P-BOX		
EXPLORER	2001	2003	FO38RMH	FO38RTE	FO38RFH*	Y	Y	TEX/CR	60	Y	P-BOX		
EXPLORER	2004		FO38RMH	FO38RTE	FO38RFH*	Y	Y	TEX/CR	63	Y	P-BOX		
EXPLORER SPORT TRAC	1998	2001	FO38RMH	FO38RTE	FO38RFH*	Y	Y	TEXAS	4C	Y	P-BOX		
EXPLORER SPORT TRAC	2002	2005	FO38RMH	FO38RTE	FO38RFH*	Y	Y	TEX/CR	60	Y	P-BOX		
FALCON	1999	2006	FO21MH	FO21TE	FO21FH*	Y	Y	TEX/CR	60	Y	P-BOX		
FOCUS	2000	2004	FO38RMH	FO38RTE	FO38RFH*	Y	Y	TEX/CR	60	Y	P-BOX		
TAURUS LX / SHO	1998	1999	FO38RMH	FO38RTE	FO38RFH*	Y	Y	TEXAS	4C	Y	P-BOX		
TERRITORY	2004	2005	FO21MH	FO21TE	FO21FH*	Y	Y	TEX/CR	60	Y	P-BOX		
TERRITORY	2005		HU101MH	HU101TE	HU101FH*	Y	Y	TEX/CR2	6F	Y	P-BOX		
TRIBUTE	2001	2003	FO38RMH	FO38RTE	FO38RFH*	Y	Y	TEX/CR	60	Y	P-BOX		
FORD EU®													
CONNECT	2002		FO21MH	FO21TE	FO21FH*	Y	Y	TEX/CR	60	Y	P-BOX		
COUGAR	1997	2002	FO21MH	FO21TE	FO21FH*	Y	Y	TEXAS	4C	Y	P-BOX		
COURIER KOMBI	1998	2002	FO21MH	FO21TE	FO21FH*	Y	Y	TEXAS	4C	Y	P-BOX		
ESCORT	1995	2000	FO21MH	FO21TE	FO21FH*	Y	Y	TEXAS	4C	Y	P-BOX		
FIESTA	1995	2002	FO21MH	FO21TE	FO21FH*	Y	Y	TEXAS	4C	Y	P-BOX		
FIESTA	2003	2008	FO21MH	FO21TE	FO21FH*	Y	Y	TEX/CR	63	Y	P-BOX		
FIESTA	2008	2012	HU101MH	HU101TE	HU101FH*	Y	Y	TEX/CR	63	Y	P-BOX		
FOCUS	1998	2004	FO21MH	FO21TE	FO21FH*	Y	Y	TEX/CR	60	Y	P-BOX		
FOCUS	2004	2010	HU101MH	HU101TE	HU101FH*	Y	Y	TEX/CR	63	Y	P-BOX		
FOCUS C-MAX	2003	2010	HU101MH	HU101TE	HU101FH*	Y	Y	TEX/CR	63	Y	P-BOX		
FUSION	2002		FO21MH	FO21TE	FO21FH*	Y	Y	TEX/CR	63	Y	P-BOX		
GALAXY	1995	1998	HU66BT1		HU66FH*			PH	33	Y	Y	S-V	S2

* Blade for "Flip" Key plastic head

See info on the uses of the keys on Silca Electronic Keys Catalogue



















1	2	2a	3	3a	3b	E1+E2		6	42+71	72	43 44a	12	15
						GTI Compatibility							
CAR MAKE/MODEL 	FROM 1995 	TO 2014 	SILCA REF.  Ref.	SILCA REF.  "TE" Silca Ref.	 SILCA REF.  "Flip Keys" Silca Ref.	COPY 	GEN. 	TRANSP. TYPE 	ID  FAST COPY PLUS RW4 PLUS FAST COPY/RW4	COPY  FAST COPY PLUS RW4 PLUS	COPY  FAST COPY RW4	STP   	
FORD EU®													
GALAXY	1995	1998	HU66DT5		HU66FH*			PH	33	Y	Y	S-V	S2
GALAXY	1998	2000	HU66T10		HU66FH*			PH/CR	42	Y	Y		
GALAXY	2000	2006	HU66BT28		HU66FH*			PH/CR	4W	RD	RD		
GALAXY	2006	2010	HU101MH	HU101TE	HU101FH*	Y	Y	TEX/CR	63	Y	P-BOX		
KA	1996	2002	FO21MH	FO21TE	FO21FH*	Y	Y	TEXAS	4C	Y	P-BOX		
KA	2002	2008	FO21MH	FO21TE	FO21FH*	Y	Y	TEX/CR	60	Y	P-BOX		
KA	2009		SIP22MH	SIP22TE	SIP22FH*	Y		PH/CR2	46	Y	P-BOX		
KUGA	2008		HU101MH	HU101TE	HU101FH*	Y	Y	TEX/CR	63	Y	P-BOX		
MAVERICK	1995	1997	NSN11T2		NSN11FH*			PH	33	Y	Y		
MONDEO	1995	2001	FO21MH	FO21TE	FO21FH*	Y	Y	TEXAS	4C	Y	P-BOX		
MONDEO	2001	2007	FO21MH	FO21TE	FO21FH*	Y	Y	TEX/CR	60	Y	P-BOX		
MONDEO	2007	2010	HU101MH	HU101TE	HU101FH*	Y	Y	TEX/CR	63	Y	P-BOX		
PUMA	1998	2002	FO21MH	FO21TE	FO21FH*	Y	Y	TEXAS	4C	Y	P-BOX		
SCORPIO	1995	1998	FO21MH	FO21TE	FO21FH*	Y	Y	TEXAS	4C	Y	P-BOX		
S-MAX	2006	2010	HU101MH	HU101TE	HU101FH*	Y	Y	TEX/CR	63	Y	P-BOX		
TRANSIT	1995	2000	FO21MH	FO21TE	FO21FH*	Y	Y	TEXAS	4C	Y	P-BOX		
TRANSIT	2000	2006	FO21MH	FO21TE	FO21FH*	Y	Y	TEX/CR	60	Y	P-BOX		
TRANSIT	2007		FO21MH	FO21TE	FO21FH*	Y	Y	TEX/CR	63	Y	P-BOX		
TRANSIT	2007		FO21MH	FO21TE	FO21FH*	Y	Y	TEX/CR2	6F	Y	P-BOX		
FORD SUD AMERICA®													
FOCUS	1998	2007	FO21MH	FO21TE	FO21FH*	Y	Y	TEX/CR	60	Y	P-BOX		
KA	2008		FO21MH	FO21TE	FO21FH*	Y	Y	TEX/CR	60	Y	P-BOX		
MONDEO	2006	2007	FO21MH	FO21TE	FO21FH*	Y	Y	TEX/CR	60	Y	P-BOX		
MONDEO	2007		HU101MH	HU101TE	HU101FH*	Y	Y	TEX/CR	63	Y	P-BOX		
RANGER	2004		FO38RMH	FO38RTE	FO38RFH*	Y	Y	TEX/CR	63	Y	P-BOX		
FORD USA®													
CONTOUR V6 LX	1998	2000	FO26MH	FO26TE	FO26FH*	Y	Y	TEXAS	4C	Y	P-BOX		
CROWN VICTORIA	1998	2002	FO38RMH	FO38RTE	FO38RFH*	Y	Y	TEXAS	4C	Y	P-BOX		
CROWN VICTORIA	2003	2012	FO38RMH	FO38RTE	FO38RFH*	Y	Y	TEX/CR	63	Y	P-BOX		
EDGE	2007	2009	FO38RMH	FO38RTE	FO38RFH*	Y	Y	TEX/CR3	6A	Y	P-BOX		
EDGE	2007	2010	FO38RMH	FO38RTE	FO38RFH*	Y	Y	TEX/CR2	6F	Y	P-BOX		
ESCAPE	2001	2004	FO38RMH	FO38RTE	FO38RFH*	Y	Y	TEX/CR	60	Y	P-BOX		
ESCAPE	2005	2012	FO38RMH	FO38RTE	FO38RFH*	Y	Y	TEX/CR	63	Y	P-BOX		
E-SERIES VAN	2008	2012	FO38RMH	FO38RTE	FO38RFH*	Y	Y	TEX/CR	63	Y	P-BOX		
EXCURSION	2000	2006	FO38RMH	FO38RTE	FO38RFH*	Y	Y	TEXAS	4C	Y	P-BOX		
EXPEDITION	1997	2002	FO38RMH	FO38RTE	FO38RFH*	Y	Y	TEXAS	4C	Y	P-BOX		

















1	2	2a	3	3a	3b	E1+E2		6	42+71	72	43 44a	12	15	
						GTI Compatibility								
CAR MAKE/MODEL 	FROM 1995 	TO 2014 	SILCA REF.  Ref.	SILCA REF.  "TE" Silca Ref.	 SILCA REF.  "Flip Keys" Silca Ref.	COPY 	GEN. 	TRANSP. TYPE 	ID  FAST COPY PLUS RW4 PLUS FAST COPY/RW4	COPY  FAST COPY PLUS RW4 PLUS	COPY  FAST COPY RW4	STP   		
FORD USA®														
EXPEDITION	2003	2010	FO38RMH	FO38RTE	FO38RFH*	Y	Y	TEX/CR	63	Y	P-BOX			
EXPLORER	1998	2001	FO38RMH	FO38RTE	FO38RFH*	Y	Y	TEXAS	4C	Y	P-BOX			
EXPLORER	2001	2003	FO38RMH	FO38RTE	FO38RFH*	Y	Y	TEX/CR	60	Y	P-BOX			
EXPLORER	2004	2010	FO38RMH	FO38RTE	FO38RFH*	Y	Y	TEX/CR	63	Y	P-BOX			
EXPLORER SPORT TRAC	1999	2001	FO38RMH	FO38RTE	FO38RFH*	Y	Y	TEXAS	4C	Y	P-BOX			
EXPLORER SPORT TRAC	2002	2010	FO38RMH	FO38RTE	FO38RFH*	Y	Y	TEX/CR	63	Y	P-BOX			
F-150	1998	2004	FO38RMH	FO38RTE	FO38RFH*	Y	Y	TEXAS	4C	Y	P-BOX			
F-150	2004	2010	FO38RMH	FO38RTE	FO38RFH*	Y	Y	TEX/CR	63	Y	P-BOX			
F-250	1998	2004	FO38RMH	FO38RTE	FO38RFH*	Y	Y	TEXAS	4C	Y	P-BOX			
F-250	2004	2010	FO38RMH	FO38RTE	FO38RFH*	Y	Y	TEX/CR	63	Y	P-BOX			
F-350	1999	2003	FO38RMH	FO38RTE	FO38RFH*	Y	Y	TEXAS	4C	Y	P-BOX			
F-350	2004	2010	FO38RMH	FO38RTE	FO38RFH*	Y	Y	TEX/CR	63	Y	P-BOX			
FIVE HUNDRED	2005	2007	FO38RMH	FO38RTE	FO38RFH*	Y	Y	TEX/CR	63	Y	P-BOX			
FLEX	2009	2009	FO38RMH	FO38RTE	FO38RFH*	Y	Y	TEX/CR3	6A	Y	P-BOX			
FLEX	2009	2010	FO38RMH	FO38RTE	FO38RFH*	Y	Y	TEX/CR2	6F	Y	P-BOX			
FOCUS	2005	2007	FO38RMH	FO38RTE	FO38RFH*	Y	Y	TEX/CR	63	Y	P-BOX			
FREESTAR	2004	2007	FO38RMH	FO38RTE	FO38RFH*	Y	Y	TEX/CR	63	Y	P-BOX			
FREESTYLE	2005	2007	FO38RMH	FO38RTE	FO38RFH*	Y	Y	TEX/CR2	6F	Y	P-BOX			
FREESTYLE	2005	2007	FO38RMH	FO38RTE	FO38RFH*	Y	Y	TEX/CR3	6A	Y	P-BOX			
FUSION	2006	2009	FO38RMH	FO38RTE	FO38RFH*	Y	Y	TEX/CR3	6A	Y	P-BOX			
FUSION	2006	2011	FO38RMH	FO38RTE	FO38RFH*	Y	Y	TEX/CR2	6F	Y	P-BOX			
MUSTANG	1998	2004	FO38RMH	FO38RTE	FO38RFH*	Y	Y	TEXAS	4C	Y	P-BOX			
MUSTANG	2005	2012	FO38RMH	FO38RTE	FO38RFH*	Y	Y	TEX/CR	63	Y	P-BOX			
MUSTANG COBRA	1996	1997	FO38RMH	FO38RTE	FO38RFH*	Y	Y	TEXAS	4C	Y	P-BOX			
MUSTANG GT	1996	1997	FO38RMH	FO38RTE	FO38RFH*	Y	Y	TEXAS	4C	Y	P-BOX			
RANGER	1999	2000	FO38RMH	FO38RTE	FO38RFH*	Y	Y	TEXAS	4C	Y	P-BOX			
RANGER	2001	2010	FO38RMH	FO38RTE	FO38RFH*	Y	Y	TEX/CR	63	Y	P-BOX			
RANGER XLT V6	1999	2000	FO38RMH	FO38RTE	FO38RFH*	Y	Y	TEXAS	4C	Y	P-BOX			
TAURUS	2000	2003	FO38RMH	FO38RTE	FO38RFH*	Y	Y	TEX/CR	60	Y	P-BOX			
TAURUS	2004	2007	FO38RMH	FO38RTE	FO38RFH*	Y	Y	TEX/CR	63	Y	P-BOX			
TAURUS	2008	2009	FO38RMH	FO38RTE	FO38RFH*	Y	Y	TEX/CR3	6A	Y	P-BOX			
TAURUS	2008	2011	FO38RMH	FO38RTE	FO38RFH*	Y	Y	TEX/CR2	6F	Y	P-BOX			
TAURUS LX / SHO	1996	1999	FO38RMH	FO38RTE	FO38RFH*	Y	Y	TEXAS	4C	Y	P-BOX			
THUNDERBIRD	2002	2005	FO38RMH	FO38RTE	FO38RFH*	Y	Y	TEX/CR	60	Y	P-BOX			
THUNDERBIRD	2002	2005	FO38RMH	FO38RTE	FO38RFH*	Y	Y	TEX/CR	63	Y	P-BOX			
TRANSIT CONNECT	2010	2012	FO21MH	FO21TE	FO21FH*	Y	Y	TEX/CR	63	Y	P-BOX			

* Blade for "Flip" Key plastic head

See info on the uses of the keys on Silca Electronic Keys Catalogue



















1	2	2a	3	3a	3b	E1+E2		6	42+71	72	43 44a	12	15	
						GTI Compatibility								
CAR MAKE/MODEL 	FROM 1995 	TO 2014 	SILCA REF.  Ref.	SILCA REF.  "TE" Silca Ref.	 SILCA REF.  "Flip Keys" Silca Ref.	COPY 	GEN. 	TRANSP. TYPE 	ID  FAST COPY PLUS RW4 PLUS FAST COPY/RW4	COPY  FAST COPY PLUS RW4 PLUS	COPY  FAST COPY RW4	STP   		
FORD USA®														
WINDSTAR	1999	2000	FO38RMH	FO38RTE	FO38RFH*	Y	Y	TEXAS	4C	Y	P-BOX			
WINDSTAR	2001	2003	FO38RMH	FO38RTE	FO38RFH*	Y	Y	TEX/CR	63	Y	P-BOX			
GMC (GM)®														
TERRAIN	2010		HU100MH	HU100TE	HU100FH*	Y		PH/CR2	46	Y	P-BOX			
HOLDEN®														
ASTRA	2004		HU100MH	HU100TE	HU100FH*	Y		PH/CR2	46	Y	P-BOX			
BARINA	2006		DWO4RT6		DWO4RFH*			MEG/CR	48					
FRONTERA	1999		HON58RT6		HON58RFH*			MEG/CR	48					
VECTRA	1995	1998	HU43T2		HU43FH*			PH	33	Y	Y	S-O		
VECTRA	1998	1999	HU43T2		HU43FH*			PH/CR	40	RD	RD			
VECTRA	1998	2004	HU43T9		HU43FH*			PH/CR	40					
VECTRA	2004		HU100MH	HU100TE	HU100FH*	Y		PH/CR2	46	Y	P-BOX			
ZAFIRA	2004		HU100MH	HU100TE	HU100FH*	Y		PH/CR2	46	Y	P-BOX			
HONDA®														
ACCORD	1999	2002	HON58RT6		HON58RFH*			MEG/CR	48					
ACCORD	2003	2006	HON66MH		HON66FH*	Y	Y	PH/CR2	46	Y	P-BOX			
ACCORD	2003	2006	HON66T6		HON66FH*			MEG/CR	48					
ACCORD	2006	2008	HON66T27		HON66FH*			SOK/CR	8E					
ACCORD	2008		HON66MH		HON66FH*	Y	Y	PH/CR2	46	Y	P-BOX			
ACCORD AERODECK	1995	1997	HON58RT5		HON58RFH*			MEG	13	Y	Y	MEG		
ACCORD COUPÈ	1995	2002	HON58RT5		HON58RFH*			MEG	13	Y	Y	MEG		
CIVIC	1995	1999	HON58RT5		HON58RFH*			MEG	13	Y	Y	MEG		
CIVIC	1999	2002	HON58RT6		HON58RFH*			MEG/CR	48					
CIVIC	2002	2005	HON66T6		HON66FH*			MEG/CR	48					
CIVIC	2006		HON66MH		HON66FH*	Y	Y	PH/CR2	46	Y	P-BOX			
CIVIC (AUSTRALIA)	2002	2005	HON66T5		HON66FH*			MEG	13	Y	Y	MEG		
CIVIC (AUSTRALIA)	2003		HON66MH		HON66FH*	Y	Y	PH/CR2	46	Y	P-BOX			
CR-V	1997	1999	HON58RT5		HON58RFH*			MEG	13	Y	Y	MEG		
CR-V	1999	2001	HON58RT6		HON58RFH*			MEG/CR	48					
CR-V	2002	2006	HON66T6		HON66FH*			MEG/CR	48					
CR-V	2007		HON66MH		HON66FH*	Y	Y	PH/CR2	46	Y	P-BOX			
CR-V (AUSTRALIA)	2002	2006	HON66T5		HON66FH*			MEG	13	Y	Y	MEG		
CR-Z	2010		HON66MH		HON66FH*	Y	Y	PH/CR2	46	Y	P-BOX			
FR-V	2004	2007	HON66T6		HON66FH*			MEG/CR	48					
FR-V	2007		HON66T27		HON66FH*			SOK/CR	8E					
HR-V	1999	2005	HON58RT6		HON58RFH*			MEG/CR	48					

1	2	2a	3	3a	3b	E1+E2		6	42+71	72	43 44a	12	15
						GTI Compatibility							
CAR MAKE/MODEL 	FROM 1995 	TO 2014 	SILCA REF.  Ref.	SILCA REF.  "TE" Silca Ref.	 SILCA REF.  "Flip Keys" Silca Ref.	COPY 	GEN. 	TRANSP. TYPE 	ID  FAST COPY PLUS RW4 PLUS FAST COPY/RW4	COPY  FAST COPY PLUS RW4 PLUS	COPY  FAST COPY RW4	STP   	
HONDA®													
INSIGHT	2001	2005	HON58RT6		HON58RFH*			MEG/CR	48				
INTEGRA	1998	2001	HON58RT5		HON58RFH*			MEG	13	Y	Y	MEG	
JAZZ	2001	2007	HON66T6		HON66FH*			MEG/CR	48				
JAZZ	2006	2008	HON66T27		HON66FH*			SOK/CR	8E				
JAZZ	2009		HON66MH		HON66FH*	Y	Y	PH/CR2	46	Y	P-BOX		
JAZZ (AUSTRALIA)	2001		HON66T5		HON66FH*			MEG	13	Y	Y	MEG	
LEGEND	1996	2004	HON58RT5		HON58RFH*			MEG	13	Y	Y	MEG	
LEGEND	2007		HON66T27		HON66FH*			SOK/CR	8E				
LOGO	1999	2001	HON58RT6		HON58RFH*			MEG/CR	48				
MDX (AUSTRALIA)	2003		HON66MH		HON66FH*	Y	Y	PH/CR2	46	Y	P-BOX		
NSX	1997	2005	HON58RT5		HON58RFH*			MEG	13	Y	Y		
PASSPORT	1998	2002	HON58RT5		HON58RFH*			MEG	13	Y	Y		
PRELUDE	1997	2001	HON58RT5		HON58RFH*			MEG	13	Y	Y		
S2000	2000	2003	HON58RT6		HON58RFH*			MEG/CR	48				
S2000	2004	2005	HON66T6		HON66FH*			MEG/CR	48				
S2000	2006	2010	HON66T27		HON66FH*			SOK/CR	8E				
SHUTTLE	1995	2000	HON58RT5		HON58RFH*			MEG	13	Y	Y	MEG	
SHUTTLE	2000	2003	HON58RT6		HON58RFH*			MEG/CR	48				
STREAM	2001	2003	HON58RT6		HON58RFH*			MEG/CR	48				
STREAM	2003	2007	HON66T6		HON66FH*			MEG/CR	48				
STREAM	2008		HON66MH		HON66FH*	Y	Y	PH/CR2	46	Y	P-BOX		
HONDA USA®													
ACCORD	1998	2002	HON58RT5		HON58RFH*			MEG	13	Y	Y		
ACCORD	2003		HON66MH		HON66FH*	Y	Y	PH/CR2	46	Y	P-BOX		
ACCORD CROSST	2010		HON66MH		HON66FH*	Y	Y	PH/CR2	46	Y	P-BOX		
CIVIC	2001	2002	HON58RT5		HON58RFH*			MEG	13	Y	Y		
CIVIC	2003	2005	HON66T5		HON66FH*			MEG	13	Y	Y		
CIVIC	2006		HON66MH		HON66FH*	Y	Y	PH/CR2	46	Y	P-BOX		
CR-V	2002	2006	HON66T5		HON66FH*			MEG	13	Y	Y		
CR-V	2007		HON66MH		HON66FH*	Y	Y	PH/CR2	46	Y	P-BOX		
CR-Z	2011		HON66MH		HON66FH*	Y	Y	PH/CR2	46	Y	P-BOX		
ELEMENT	2003	2005	HON66T5		HON66FH*			MEG	13	Y	Y		
ELEMENT	2006	2011	HON66MH		HON66FH*	Y	Y	PH/CR2	46	Y	P-BOX		
FIT	2007	2008	HON66T27		HON66FH*			SOK/CR	8E				
FIT	2009		HON66MH		HON66FH*	Y	Y	PH/CR2	46	Y	P-BOX		
INSIGHT	2000	2006	HON58RT5		HON58RFH*			MEG	13	Y	Y		

* Blade for "Flip" Key plastic head

















See info on the uses of the keys on Silca Electronic Keys Catalogue



1	2	2a	3	3a	3b	E1+E2		6	42+71	72	43 44a	12	15
						GTI Compatibility							
CAR MAKE/MODEL 	FROM 1995 	TO 2014 	SILCA REF.  Ref.	SILCA REF.  "TE" Silca Ref.	 SILCA REF.  "Flip Keys" Silca Ref.	COPY 	GEN. 	TRANSP. TYPE 	ID  FAST COPY PLUS RW4 PLUS FAST COPY/RW4	COPY  FAST COPY PLUS RW4 PLUS	COPY  FAST COPY RW4	STP   	
HONDA USA®													
INSIGHT	2010		HON66MH		HON66FH*	Y	Y	PH/CR2	46	Y	P-BOX		
ODYSSEY	1998	2002	HON58RT5		HON58RFH*			MEG	13	Y	Y		
ODYSSEY	2003	2004	HON66T5		HON66FH*			MEG	13	Y	Y		
ODYSSEY	2005		HON66MH		HON66FH*	Y	Y	PH/CR2	46	Y	P-BOX		
PILOT	2003	2005	HON66T5		HON66FH*			MEG	13	Y	Y		
PILOT	2006		HON66MH		HON66FH*	Y	Y	PH/CR2	46	Y	P-BOX		
PRELUDE	1997	2002	HON58RT5		HON58RFH*			MEG	13	Y	Y	MEG	
RIDGELINE	2005		HON66MH		HON66FH*	Y	Y	PH/CR2	46	Y	P-BOX		
S2000	2000	2002	HON58RT5		HON58RFH*			MEG	13	Y	Y		
S2000	2003	2005	HON66T5		HON66FH*			MEG	13	Y	Y		
S2000	2006	2010	HON66T27		HON66FH*			SOK/CR	8E				
HYUNDAI®													
ACCENT	1996	1999	HYN10MH	HYN10TE	HYN10FH*	Y	Y	TEXAS	4C	Y	P-BOX		
ACCENT	1999	2011	HYN6MH	HYN6TE	HYN6FH*	Y	Y	PH/CR2	46	Y	P-BOX		
ATOS	1997	2000	HYN10MH	HYN10TE	HYN10FH*	Y	Y	TEXAS	4C	Y	P-BOX		
ATOS PRIME	1999	2001	HYN10MH	HYN10TE	HYN10FH*	Y	Y	TEXAS	4C	Y	P-BOX		
ATOS PRIME	2002	2008	HYN10MH	HYN10TE	HYN10FH*	Y	Y	PH/CR2	46	Y	P-BOX		
AZERA	2005	2010	TOY40MH		TOY40FH*	Y	Y	PH/CR2	46	Y	P-BOX		
COUPE	1996	2001	HYN6MH	HYN6TE	HYN6FH*	Y	Y	TEXAS	4C	Y	P-BOX		
COUPE	2001	2009	HYN6MH	HYN6TE	HYN6FH*	Y	Y	PH/CR2	46	Y	P-BOX		
ELANTRA	2000	2006	HYN6MH	HYN6TE	HYN6FH*	Y	Y	PH/CR2	46	Y	P-BOX		
ELANTRA	2007		HYN14RMH	HYN14RTE	HYN14RFH*	Y	Y	PH/CR2	46	Y	P-BOX		
ELANTRA NEOS	2007		TOY40MH		TOY40FH*	Y	Y	PH/CR2	46	Y	P-BOX		
ENTOURAGE	2007	2009	HYN14MH	HYN14TE	HYN14FH*	Y	Y	PH/CR2	46	Y	P-BOX		
EXCEL	1996	1999	HYN10MH	HYN10TE	HYN10FH*	Y	Y	TEXAS	4C	Y	P-BOX		
EXCEL	1999		HYN6MH	HYN6TE	HYN6FH*	Y	Y	PH/CR2	46	Y	P-BOX		
GALLOPER	1999	2003	HYN6MH	HYN6TE	HYN6FH*	Y	Y	TEXAS	4C	Y	P-BOX		
GENESIS	2009		TOY40MH		TOY40FH*	Y	Y	PH/CR2	46	Y	P-BOX		
GENESIS C.PE	2010		HYN14RMH	HYN14RTE	HYN14RFH*	Y	Y	PH/CR2	46	Y	P-BOX		
GETZ	2002	2009	HYN6MH	HYN6TE	HYN6FH*	Y	Y	PH/CR2	46	Y	P-BOX		
GRANDEUR	2006		TOY40MH		TOY40FH*	Y	Y	PH/CR2	46	Y	P-BOX		
GRANDEUR XG (AUS)	1998	2005	HYN7RMH		HYN7RFH*	Y	Y	TEX/CR	60	Y	P-BOX		
H-1	1999	2006	HYN6MH	HYN6TE	HYN6FH*	Y	Y	TEXAS	4C	Y	P-BOX		
H-1	2006		HYN6MH	HYN6TE	HYN6FH*	Y	Y	PH/CR2	46	Y	P-BOX		
H-1 BUS	2007		HYN14MH	HYN14TE	HYN14FH*	Y	Y	PH/CR2	46	Y	P-BOX		
I10	2008		HYN14MH	HYN14TE	HYN14FH*	Y	Y	PH/CR2	46	Y	P-BOX		

* Blade for "Flip" Key plastic head

















See info on the uses of the keys on Silca Electronic Keys Catalogue 

1	2	2a	3	3a	3b	E1+E2		6	42+71	72	43 44a	12	15	
						GTI Compatibility								
CAR MAKE/MODEL 	FROM 1995 	TO 2014 	SILCA REF.  Ref.	SILCA REF.  "TE" Silca Ref.	 SILCA REF.  "Flip Keys" Silca Ref.	COPY 	GEN. 	TRANSP. TYPE 	ID  FAST COPY PLUS RW4 PLUS FAST COPY/RW4	COPY  FAST COPY PLUS RW4 PLUS	COPY  FAST COPY RW4	STP  		
HYUNDAI®														
I20	2008		TOY40MH		TOY40FH*	Y	Y	PH/CR2	46	Y	P-BOX			
I20	2008		TOY49MH		TOY49FH*	Y	Y	PH/CR2	46	Y	P-BOX			
I30	2007	2011	TOY40MH		TOY40FH*	Y	Y	PH/CR2	46	Y	P-BOX			
I30	2007	2011	TOY49MH		TOY49FH*	Y	Y	PH/CR2	46	Y	P-BOX			
I40 (AUS)	2010		TOY49MH		TOY49FH*	Y	Y	PH/CR2	46	Y	P-BOX			
I45	2009		TOY49MH		TOY49FH*	Y	Y	PH/CR2	46	Y	P-BOX			
ILOAD	2008		HYN14RMH	HYN14RTE	HYN14RFH*	Y	Y	PH/CR2	46	Y	P-BOX			
IMAX	2008		HYN14RMH	HYN14RTE	HYN14RFH*	Y	Y	PH/CR2	46	Y	P-BOX			
INNOVATION	1999	2003	HYN6MH	HYN6TE	HYN6FH*	Y	Y	TEXAS	4C	Y	P-BOX			
IX20	2010		TOY49MH		TOY49FH*	Y	Y	PH/CR2	46	Y	P-BOX			
IX35	2010		TOY49MH		TOY49FH*	Y	Y	PH/CR2	46	Y	P-BOX			
LANTRA	1996	2000	HYN6MH	HYN6TE	HYN6FH*	Y	Y	TEXAS	4C	Y	P-BOX			
LAVITA	2001	2010	HYN6MH	HYN6TE	HYN6FH*	Y	Y	PH/CR2	46	Y	P-BOX			
MATRIX	2002	2010	HYN6MH	HYN6TE	HYN6FH*	Y	Y	PH/CR2	46	Y	P-BOX			
PONY	1995	1999	HYN10MH	HYN10TE	HYN10FH*	Y	Y	TEXAS	4C	Y	P-BOX			
SANTAFE	2000	2002	HYN7RMH		HYN7RFH*	Y	Y	TEX/CR	60	Y	P-BOX			
SANTAFE	2002	2006	HYN6MH	HYN6TE	HYN6FH*	Y	Y	PH/CR2	46	Y	P-BOX			
SANTAFE	2006		HYN14RMH	HYN14RTE	HYN14RFH*	Y	Y	PH/CR2	46	Y	P-BOX			
SANTAMO	2000	2003	HYN6MH	HYN6TE	HYN6FH*	Y	Y	TEXAS	4C	Y	P-BOX			
SCOUPE	1996		HYN6MH	HYN6TE	HYN6FH*	Y	Y	TEXAS	4C	Y	P-BOX			
SONATA	1996	1998	HYN7RMH		HYN7RFH*	Y	Y	TEXAS	4C	Y	P-BOX			
SONATA	1998	2004	HYN7RMH		HYN7RFH*	Y	Y	TEX/CR	60	Y	P-BOX			
SONATA	2005		HYN14RMH	HYN14RTE	HYN14RFH*	Y	Y	PH/CR2	46	Y	P-BOX			
SONICA	1996	1998	HYN7RMH		HYN7RFH*	Y	Y	TEXAS	4C	Y	P-BOX			
SONICA	1999	2004	HYN7RMH		HYN7RFH*	Y	Y	TEX/CR	60	Y	P-BOX			
TERRACAN	2001	2007	HYN6MH	HYN6TE	HYN6FH*	Y	Y	PH/CR2	46	Y	P-BOX			
TIBURON	2001	2008	HYN6MH	HYN6TE	HYN6FH*	Y	Y	PH/CR2	46	Y	P-BOX			
TRAJET	2000	2006	HYN7RMH		HYN7RFH*	Y	Y	TEX/CR	60	Y	P-BOX			
TUCSON	2005	2009	HYN6MH	HYN6TE	HYN6FH*	Y	Y	PH/CR2	46	Y	P-BOX			
VERACRUZ	2007		HYN14RMH	HYN14RTE	HYN14RFH*	Y	Y	PH/CR2	46	Y	P-BOX			
VERNA	1996	1999	HYN10MH	HYN10TE	HYN10FH*	Y	Y	TEXAS	4C	Y	P-BOX			
VERNA	1999		HYN6MH	HYN6TE	HYN6FH*	Y	Y	PH/CR2	46	Y	P-BOX			
XG25/XG30	1998	2005	HYN7RMH		HYN7RFH*	Y	Y	TEX/CR	60	Y	P-BOX			
XG300 (CANADA)	1998	2005	HYN7RMH		HYN7RFH*	Y	Y	TEX/CR	60	Y	P-BOX			
INFINITY®														
FX35	2003	2009	NSN14MH	NSN14TE	NSN14FH*	Y	Y	PH/CR2	46	Y	P-BOX			

* Blade for "Flip" Key plastic head

See info on the uses of the keys on Silca Electronic Keys Catalogue



1	2	2a	3	3a	3b	E1+E2		6	42+71	72	43 44a	12	15
						GTI Compatibility							
CAR MAKE/MODEL 	FROM 1995 	TO 2014 	SILCA REF.  Ref.	SILCA REF.  "TE" Silca Ref.	 SILCA REF.  "Flip Keys" Silca Ref.	COPY 	GEN. 	TRANSP. TYPE 	ID  FAST COPY PLUS RW4 PLUS FAST COPY/RW4	COPY  FAST COPY PLUS RW4 PLUS	COPY  FAST COPY RW4	STP   	
INFINITY®													
FX45	2003	2009	NSN14MH	NSN14TE	NSN14FH*	Y	Y	PH/CR2	46	Y	P-BOX		
G20	2000	2002	NSN14MH	NSN14TE	NSN14FH*	Y	Y	TEX/CR	60	Y	P-BOX		
G35	2003	2007	NSN14MH	NSN14TE	NSN14FH*	Y	Y	PH/CR2	46	Y	P-BOX		
I30	1999	2000	NSN11T2		NSN11FH*			PH	33	Y	Y	N-N	
I30	2001	2004	NSN14MH	NSN14TE	NSN14FH*	Y	Y	TEX/CR	60	Y	P-BOX		
I35	2001	2004	NSN14MH	NSN14TE	NSN14FH*	Y	Y	TEX/CR	60	Y	P-BOX		
M35	2003	2004	NSN14MH	NSN14TE	NSN14FH*	Y	Y	PH/CR2	46	Y	P-BOX		
M45	2003	2006	NSN14MH	NSN14TE	NSN14FH*	Y	Y	PH/CR2	46	Y	P-BOX		
Q45	1997	2000	NSN14MH	NSN14TE	NSN14FH*	Y	Y	TEXAS	4C	Y	P-BOX		
Q45	2001	2005	NSN14MH	NSN14TE	NSN14FH*	Y	Y	PH/CR2	46	Y	P-BOX		
QX4	1997	1999	NSN14MH	NSN14TE	NSN14FH*	Y	Y	TEXAS	4C	Y	P-BOX		
QX4	1999	2003	NSN14MH	NSN14TE	NSN14FH*	Y	Y	TEX/CR	60	Y	P-BOX		
QX56	2004	2007	NSN14MH	NSN14TE	NSN14FH*	Y	Y	PH/CR2	46	Y	P-BOX		
ISUZU®													
AMIGO	1998	2000	HON58R		HON58RFH*								
AXIOM	2002	2002	HON58R		HON58RFH*								
BIG HORN	1998	2002	SZ12MH	SZ12TE	SZ12FH*	Y	Y	TEX/CR	64	Y	P-BOX		
TROOPER	1998	2002	SZ12MH	SZ12TE	SZ12FH*	Y	Y	TEX/CR	64	Y	P-BOX		
IVECO®													
35C11	2000		GT10MH		GT10FH*	Y		PH/CR2	46	Y	P-BOX		
EUROCARGO	2002	2007	SIP22MH	SIP22TE	SIP22FH*	Y		PH/CR2	46	Y	P-BOX		
EUROSTAR	1998	2002	GT10MH		GT10FH*	Y		PH/CR2	46	Y	P-BOX		
NEW DAILY	1998		GT10MH		GT10FH*	Y		PH/CR2	46	Y	P-BOX		
S-2000	1998		GT10MH		GT10FH*	Y		PH/CR2	46	Y	P-BOX		
STRALIS	2002	2007	SIP22MH	SIP22TE	SIP22FH*	Y		PH/CR2	46	Y	P-BOX		
JAGUAR®													
S-TYPE	2000	2008	FO21MH	FO21TE	FO21FH*	Y	Y	TEX/CR	60	Y	P-BOX		
XJ	2003	2007	FO21MH	FO21TE	FO21FH*	Y	Y	TEX/CR	60	Y	P-BOX		
X-TYPE	2002	2008	FO21MH	FO21TE	FO21FH*	Y	Y	TEX/CR	60	Y	P-BOX		
JEEP®													
CHEROKEE	1998	2004	CY24MH		CY24FH*	Y	Y	TEX/CR	64	Y	P-BOX		
CHEROKEE	2005		CY24MH		CY24FH*	Y	Y	PH/CR2	46	Y	P-BOX		
CHEROKEE LIMITED	1999	2005	CY24MH		CY24FH*	Y	Y	TEX/CR	64	Y	P-BOX		
CJ5,CJ7	1998	2005	CY24MH		CY24FH*	Y	Y	TEX/CR	64	Y	P-BOX		
CJ5,CJ7	2006		CY24MH		CY24FH*	Y	Y	PH/CR2	46	Y	P-BOX		
COMANCHE	2006		CY24MH		CY24FH*	Y	Y	PH/CR2	46	Y	P-BOX		

* Blade for "Flip" Key plastic head

See info on the uses of the keys on Silca Electronic Keys Catalogue 

Car Keys Guide / Guida Chiavi Auto / Führer für Autoschlüssel / Guide Clés pour Voitures
 Guía Llaves para Coches / Guia Chaves para Carros

















New Updates

















1	2	2a	3	3a	3b	E1+E2		6	42+71	72	43 44a	12	15
						GTI Compatibility							
CAR MAKE/MODEL 	FROM 1995 	TO 2014 	SILCA REF. Ref.	SILCA REF. "TE" Silca Ref.	SILCA REF. "Flip Keys" Silca Ref.	COPY 	GEN. 	TRANSP. TYPE 	ID FAST COPY PLUS RW4 PLUS FAST COPY/RW4	COPY FAST COPY PLUS RW4 PLUS	COPY FAST COPY RW4	STP 	
JEEP®													
COMMANDER	2006	2008	CY24MH		CY24FH*	Y	Y	PH/CR2	46	Y	P-BOX		
COMPASS	2007		CY24MH		CY24FH*	Y	Y	PH/CR2	46	Y	P-BOX		
G. CHEROKEE	2005	2008	CY24MH		CY24FH*	Y	Y	PH/CR2	46	Y	P-BOX		
G.CHEROKEE LUX	1999	2005	CY24MH		CY24FH*	Y	Y	TEX/CR	64	Y	P-BOX		
G.CHEROKEE SPORT	1998	2004	CY24MH		CY24FH*	Y	Y	TEX/CR	64	Y	P-BOX		
LIBERTY	2002	2004	CY24MH		CY24FH*	Y	Y	TEX/CR	64	Y	P-BOX		
LIBERTY	2005		CY24MH		CY24FH*	Y	Y	PH/CR2	46	Y	P-BOX		
PATRIOT	2007		CY24MH		CY24FH*	Y	Y	PH/CR2	46	Y	P-BOX		
WRANGLER	1998	2006	CY24MH		CY24FH*	Y	Y	TEX/CR	64	Y	P-BOX		
WRANGLER	2006		CY24MH		CY24FH*	Y	Y	PH/CR2	46	Y	P-BOX		
KIA®													
AMANTI	2004	2006	TOY40MH		TOY40FH*	Y	Y	TEX/CR	60	Y	P-BOX		
AMANTI	2007	2010	TOY40MH		TOY40FH*	Y	Y	PH/CR2	46	Y	P-BOX		
BORREGO	2009	2011	TOY49MH		TOY49FH*	Y	Y	PH/CR2	46	Y	P-BOX		
CARENS	2001	2006	KIA3RMH		KIA3RFH*	Y	Y	TEX/CR	60	Y	P-BOX		
CARENS	2001	2006	KIA3RMH		KIA3RFH*	Y	Y	PH/CR2	46	Y	P-BOX		
CARENS	2006		HYN14MH	HYN14TE	HYN14FH*	Y	Y	PH/CR2	46	Y	P-BOX		
CARNIVAL	2002	2005	KIA3RMH		KIA3RFH*	Y	Y	PH/CR2	46	Y	P-BOX		
CARNIVAL	2006		HYN14MH	HYN14TE	HYN14FH*	Y	Y	PH/CR2	46	Y	P-BOX		
CEE'D	2007	2011	TOY40MH		TOY40FH*	Y	Y	PH/CR2	46	Y	P-BOX		
CEE'D SW	2007	2011	TOY40MH		TOY40FH*	Y	Y	PH/CR2	46	Y	P-BOX		
CLARUS	1998	2001	KIA3RT5		KIA3RFH*			MEG	13	Y	Y		
FORTE (CDN)	2008	2011	HYN14RMH	HYN14RTE	HYN14RFH*	Y	Y	PH/CR2	46	Y	P-BOX		
JOICE	2000	2003	KIA3RMH		KIA3RFH*	Y	Y	TEX/CR	60	Y	P-BOX		
MAGENTIS	2001	2006	KIA3RMH		KIA3RFH*	Y	Y	PH/CR2	46	Y	P-BOX		
MAGENTIS	2006	2008	HYN14RMH	HYN14RTE	HYN14RFH*	Y	Y	PH/CR2	46	Y	P-BOX		
MAGENTIS	2009	2011	TOY49MH		TOY49FH*	Y	Y	PH/CR2	46	Y	P-BOX		
MENTOR	2002	2004	KIA3RMH		KIA3RFH*	Y	Y	PH/CR2	46	Y	P-BOX		
MORNING	2006		HYN6MH	HYN6TE	HYN6FH*	Y	Y	PH/CR2	46	Y	P-BOX		
OPIRUS	2003	2006	TOY40MH		TOY40FH*	Y	Y	TEX/CR	60	Y	P-BOX		
OPIRUS	2007	2010	TOY49MH		TOY49FH*	Y	Y	PH/CR2	46	Y	P-BOX		
OPTIMA	2001	2006	KIA3RMH		KIA3RFH*	Y	Y	PH/CR2	46	Y	P-BOX		
OPTIMA	2006		HYN14MH	HYN14TE	HYN14FH*	Y	Y	PH/CR2	46	Y	P-BOX		
PICANTO	2004	2008	HYN6MH	HYN6TE	HYN6FH*	Y	Y	PH/CR2	46	Y	P-BOX		
PICANTO	2008	2011	TOY40MH		TOY40FH*	Y	Y	PH/CR2	46	Y	P-BOX		
RIO	2001	2005	KIA3RMH		KIA3RFH*	Y	Y	TEX/CR	60	Y	P-BOX		

* Blade for "Flip" Key plastic head

See info on the uses of the keys on Silca Electronic Keys Catalogue



















1	2	2a	3	3a	3b	E1+E2		6	42+71	72	43 44a	12	15
						GTI Compatibility							
CAR MAKE/MODEL 	FROM 1995 	TO 2014 	SILCA REF.  Ref.	SILCA REF.  "TE" Silca Ref.	 SILCA REF.  "Flip Keys" Silca Ref.	COPY 	GEN. 	TRANSP. TYPE 	ID  FAST COPY PLUS RW4 PLUS FAST COPY/RW4	COPY  FAST COPY PLUS RW4 PLUS	COPY  FAST COPY RW4	STP   	
KIA®													
RIO	2010	2011	TOY49MH		TOY49FH*	Y	Y	PH/CR2	46	Y	P-BOX		
RONDO	2001	2006	KIA3RMH		KIA3RFH*	Y	Y	TEX/CR	60	Y	P-BOX		
RONDO	2007	2010	HYN14RMH	HYN14RTE	HYN14RFH*	Y	Y	PH/CR2	46	Y	P-BOX		
RONDO	2011		TOY40MH		TOY40FH*	Y	Y	PH/CR2	46	Y	P-BOX		
SEDONA	2002	2005	KIA3RMH		KIA3RFH*	Y	Y	PH/CR2	46	Y	P-BOX		
SEDONA	2006		HYN14MH	HYN14TE	HYN14FH*	Y	Y	PH/CR2	46	Y	P-BOX		
SEPHIA	2002	2004	KIA3RMH		KIA3RFH*	Y	Y	PH/CR2	46	Y	P-BOX		
SHUMA	1998	2001	KIA3RT5		KIA3RFH*			MEG	13	Y	Y		
SORENTO	2002	2009	HYN7RMH		HYN7RFH*	Y	Y	PH/CR2	46	Y	P-BOX		
SORENTO	2010		TOY40MH		TOY40FH*	Y	Y	PH/CR2	46	Y	P-BOX		
SOUL	2009		HYN14RMH	HYN14RTE	HYN14RFH*	Y	Y	PH/CR2	46	Y	P-BOX		
SPORTAGE	1998	1999	KIA3RT5		KIA3RFH*			MEG	13	Y	Y		
SPORTAGE	2001	2003	KIA3RMH		KIA3RFH*	Y	Y	TEX/CR	60	Y	P-BOX		
SPORTAGE	2006		HYN6MH	HYN6TE	HYN6FH*	Y	Y	PH/CR2	46	Y	P-BOX		
LANCIA®													
DELTA	2008		SIP22MH	SIP22TE	SIP22FH*	Y		PH/CR2	46	Y	P-BOX		
MUSA	2009		SIP22MH	SIP22TE	SIP22FH*	Y		PH/CR2	46	Y	P-BOX		
PHEDRA	2002	2011	HU83MH	HU83TE	HU83FH*	Y	Y	PH/CR2	46	Y	P-BOX		
SOME MODELS	1995		GT15RMH		GT15RFH*								
YPSILON	2011		SIP22MH	SIP22TE	SIP22FH*	Y		PH/CR2	46	Y	P-BOX		
LAND ROVER®													
DISCOVERY 3	2006	2009	HU101MH	HU101TE	HU101FH*	Y		PH/CR2	46	Y	P-BOX		
RANGE ROVER SPORT	2006	2009	HU101MH	HU101TE	HU101FH*	Y		PH/CR2	46	Y	P-BOX		
LEXUS®													
ALTEZZA [J]	1999		TOY48MH		TOY48FH*	Y	Y	TEXAS	4C	Y	P-BOX		
CELSIOR [J]	1997		TOY40MH	TOY40BTE	TOY40FH*	Y	Y	TEXAS	4C	Y	P-BOX		
ES300	1998	2001	TOY40MH	TOY40BTE	TOY40FH*	Y	Y	TEXAS	4C	Y	P-BOX		
ES300	2002	2003	TOY48MH		TOY48FH*	Y	Y	TEXAS	4C	Y	P-BOX		
ES330	2004	2007	TOY48MH		TOY48FH*	Y		TEX/CR	68	Y	P-BOX		
GS/LS/LX	1998		TOY48MH		TOY48FH*	Y	Y	TEXAS	4C	Y	P-BOX		
GS300	1998	2005	TOY48MH		TOY48FH*	Y	Y	TEXAS	4C	Y	P-BOX		
GS300	2005	2007	TOY48MH		TOY48FH*	Y		TEX/CR	68	Y	P-BOX		
GS300/400 [J]	1998		TOY48MH		TOY48FH*	Y	Y	TEXAS	4C	Y	P-BOX		
GS400	1998	2001	TOY48MH		TOY48FH*	Y	Y	TEXAS	4C	Y	P-BOX		
GS430	2001	2005	TOY48MH		TOY48FH*	Y	Y	TEXAS	4C	Y	P-BOX		
GS430	2005	2007	TOY48MH		TOY48FH*	Y		TEX/CR	68	Y	P-BOX		

1	2	2a	3	3a	3b	E1+E2		6	42+71	72	43 44a	12	15
						GTI Compatibility							
CAR MAKE/MODEL 	FROM 1995 	TO 2014 	SILCA REF.  Ref.	SILCA REF.  "TE" Silca Ref.	 SILCA REF.  "Flip Keys" Silca Ref.	COPY 	GEN. 	TRANSP. TYPE 	ID  FAST COPY PLUS RW4 PLUS FAST COPY/RW4	COPY  FAST COPY PLUS RW4 PLUS	COPY  FAST COPY RW4	STP  	
LEXUS®													
GX470	2003	2007	TOY48MH		TOY48FH*	Y		TEX/CR	68	Y	P-BOX		
IS200	1999	2005	TOY48MH		TOY48FH*	Y	Y	TEXAS	4C	Y	P-BOX		
IS300	2001	2005	TOY48MH		TOY48FH*	Y	Y	TEXAS	4C	Y	P-BOX		
LAND CRUISER [J]	1999		TOY40MH	TOY40BTE	TOY40FH*	Y	Y	TEXAS	4C	Y	P-BOX		
LS200	1999		TOY48MH		TOY48FH*	Y	Y	TEXAS	4C	Y	P-BOX		
LS400	1997	2000	TOY40MH	TOY40BTE	TOY40FH*	Y	Y	TEXAS	4C	Y	P-BOX		
LS400	1999	2003	TOY48MH		TOY48FH*	Y	Y	TEXAS	4C	Y	P-BOX		
LS430	2001	2006	TOY48MH		TOY48FH*	Y		TEX/CR	68	Y	P-BOX		
LX450	1998		TOY40MH	TOY40BTE	TOY40FH*	Y	Y	TEXAS	4C	Y	P-BOX		
LX470	1999	2000	TOY40MH	TOY40BTE	TOY40FH*	Y	Y	TEXAS	4C	Y	P-BOX		
LX470	2001	2002	TOY48MH		TOY48FH*	Y	Y	TEXAS	4C	Y	P-BOX		
LX470	2003	2008	TOY48MH		TOY48FH*	Y		TEX/CR	68	Y	P-BOX		
RX300	1999	2003	TOY48MH		TOY48FH*	Y	Y	TEXAS	4C	Y	P-BOX		
RX330	2004	2009	TOY48MH		TOY48FH*	Y		TEX/CR	68	Y	P-BOX		
RX350	2004	2011	TOY48MH		TOY48FH*	Y		TEX/CR	68	Y	P-BOX		
RX400H	2005	2009	TOY48MH		TOY48FH*	Y		TEX/CR	68	Y	P-BOX		
RX450H	2010		TOY48MH		TOY48FH*	Y		TEX/CR	68	Y	P-BOX		
SC300/400	1998	2003	TOY40MH	TOY40BTE	TOY40FH*	Y	Y	TEXAS	4C	Y	P-BOX		
SC430	2002	2010	TOY48MH		TOY48FH*	Y		TEX/CR	68	Y	P-BOX		
LINCOLN®													
AVIATOR	2003	2007	FO38RMH	FO38RTE	FO38RFH*	Y	Y	TEX/CR	63	Y	P-BOX		
BLACKWOOD	2002	2003	FO38RMH	FO38RTE	FO38RFH*	Y	Y	TEXAS	4C	Y	P-BOX		
CONTINENTAL	1998	2002	FO38RMH	FO38RTE	FO38RFH*	Y	Y	TEXAS	4C	Y	P-BOX		
CONTINENTAL	2002	2004	FO38RMH	FO38RTE	FO38RFH*	Y	Y	TEX/CR	63	Y	P-BOX		
LHS	1998		FO38RMH	FO38RTE	FO38RFH*	Y	Y	TEXAS	4C	Y	P-BOX		
LS	2000	2006	FO38RMH	FO38RTE	FO38RFH*	Y	Y	TEX/CR	60	Y	P-BOX		
LS	2003	2006	FO38RMH	FO38RTE	FO38RFH*	Y	Y	TEX/CR	63	Y	P-BOX		
MARK LT	2005	2009	FO38RMH	FO38RTE	FO38RFH*	Y	Y	TEX/CR	63	Y	P-BOX		
MKX	2007	2010	FO38RMH	FO38RTE	FO38RFH*	Y	Y	TEX/CR	63	Y	P-BOX		
MKZ	2006	2011	FO38RMH	FO38RTE	FO38RFH*	Y	Y	TEX/CR	63	Y	P-BOX		
NAVIGATOR	1997	2002	FO38RMH	FO38RTE	FO38RFH*	Y	Y	TEXAS	4C	Y	P-BOX		
NAVIGATOR	2002	2008	FO38RMH	FO38RTE	FO38RFH*	Y	Y	TEX/CR	63	Y	P-BOX		
TOWN CAR	1998	2002	FO38RMH	FO38RTE	FO38RFH*	Y	Y	TEXAS	4C	Y	P-BOX		
TOWN CAR	2003		FO38RMH	FO38RTE	FO38RFH*	Y	Y	TEX/CR	63	Y	P-BOX		
ZEPHYR	2006		FO38RMH	FO38RTE	FO38RFH*	Y	Y	TEX/CR	63	Y	P-BOX		

* Blade for "Flip" Key plastic head

















See info on the uses of the keys on Silca Electronic Keys Catalogue



1	2	2a	3	3a	3b	E1+E2		6	42+71	72	43 44a	12	15	
						GTI Compatibility								
CAR MAKE/MODEL 	FROM 1995 	TO 2014 	SILCA REF.  Ref.	SILCA REF.  "TE" Silca Ref.	 SILCA REF.  "Flip Keys" Silca Ref.	COPY 	GEN. 	TRANSP. TYPE 	ID  FAST COPY PLUS RW4 PLUS FAST COPY/RW4	COPY  FAST COPY PLUS RW4 PLUS	COPY  FAST COPY RW4	STP  		
MARUTI SUZUKI®														
ALTO	2007	2010	SZ11MH	SZ11TE	SZ11FH*	Y	Y	TEX/CR	65	Y	P-BOX			
ALTO K10	2010		HU133RMH	HU133RTE	HU133RFH*	Y	Y	PH/CR2	46	Y	P-BOX			
A-STAR	2007		HU133RMH	HU133RTE	HU133RFH*	Y	Y	PH/CR2	46	Y	P-BOX			
RITZ	2007		HU133RMH	HU133RTE	HU133RFH*	Y	Y	PH/CR2	46	Y	P-BOX			
SWIFT	2007		HU133RMH	HU133RTE	HU133RFH*	Y	Y	PH/CR2	46	Y	P-BOX			
SWIFT [D]	2007	2009	HU133RT12		HU133RFH*			PH/CR	40					
SX4	2007		HU133RMH	HU133RTE	HU133RFH*	Y	Y	PH/CR2	46	Y	P-BOX			
VERSA	2007	2010	SZ11RMH	SZ11RTE	SZ11RFH*	Y	Y	TEX/CR	65	Y	P-BOX			
WAGON R	2007	2010	SZ11RMH	SZ11RTE	SZ11RFH*	Y	Y	TEX/CR	65	Y	P-BOX			
WAGON R	2010		HU133RMH	HU133RTE	HU133RFH*	Y	Y	PH/CR2	46	Y	P-BOX			
ZEN ESTILO	2007	2010	SZ11RMH	SZ11RTE	SZ11RFH*	Y	Y	TEX/CR	65	Y	P-BOX			
MAZDA®														
121	1997	2001	FO21MH	FO21TE	FO21FH*	Y	Y	TEXAS	4C	Y	P-BOX			
323	1997	1999	MAZ24RT5		MAZ24RFH*			PH	33	Y	Y			
323	1998	1999	MAZ24RT5		MAZ24RFH*			TEMIC	12	Y	Y			
626 (ES, LS, LUX)	1998	1999	MAZ24RT5		MAZ24RFH*			PH	33	Y	Y		D	
CX-7	2007		MAZ24RMH		MAZ24RFH*	Y	Y	TEX/CR	63	Y	P-BOX			
CX-9	2007		MAZ24RMH		MAZ24RFH*	Y	Y	TEX/CR	63	Y	P-BOX			
DEMIO [J]	2003		MAZ24RMH		MAZ24RFH*	Y	Y	TEX/CR	63	Y	P-BOX			
MAZDA 2	2003		MAZ24RMH		MAZ24RFH*	Y	Y	TEX/CR	63	Y	P-BOX			
MAZDA 3	2004		MAZ24RMH		MAZ24RFH*	Y	Y	TEX/CR	63	Y	P-BOX			
MAZDA 5	2005		MAZ24RMH		MAZ24RFH*	Y	Y	TEX/CR	63	Y	P-BOX			
MAZDA 6	2003		MAZ24RMH		MAZ24RFH*	Y	Y	TEX/CR	63	Y	P-BOX			
MX-5	1998	2000	MAZ24RT5		MAZ24RFH*			PH	33	Y	Y			
MX-5	2005		MAZ24RMH		MAZ24RFH*	Y	Y	TEX/CR	63	Y	P-BOX			
RX-8	2004		MAZ24RMH		MAZ24RFH*	Y	Y	TEX/CR	63	Y	P-BOX			
MERCURY®														
COUGAR	1999	2002	FO26MH	FO26TE	FO26FH*	Y	Y	TEXAS	4C	Y	P-BOX			
GRAND MARQUIS	1998	2002	FO38RMH	FO38RTE	FO38RFH*	Y	Y	TEXAS	4C	Y	P-BOX			
GRAND MARQUIS	2003	2007	FO38RMH	FO38RTE	FO38RFH*	Y	Y	TEX/CR	63	Y	P-BOX			
MARAUDER	2003	2005	FO38RMH	FO38RTE	FO38RFH*	Y	Y	TEX/CR	63	Y	P-BOX			
MARINER	2005	2011	FO38RMH	FO38RTE	FO38RFH*	Y	Y	TEX/CR	63	Y	P-BOX			
MILAN	2006	2011	FO38RMH	FO38RTE	FO38RFH*	Y	Y	TEX/CR	63	Y	P-BOX			
MONTEGO	2005	2008	FO38RMH	FO38RTE	FO38RFH*	Y	Y	TEX/CR	63	Y	P-BOX			
MONTEREY	2004	2007	FO38RMH	FO38RTE	FO38RFH*	Y	Y	TEX/CR	63	Y	P-BOX			
MOUNTAINEER	1998	2001	FO38RMH	FO38RTE	FO38RFH*	Y	Y	TEXAS	4C	Y	P-BOX			

* Blade for "Flip" Key plastic head

















See info on the uses of the keys on Silca Electronic Keys Catalogue 

1	2	2a	3	3a	3b	E1+E2		6	42+71	72	43 44a	12	15	
						GTI Compatibility								
CAR MAKE/MODEL 	FROM 1995 	TO 2014 	SILCA REF.  Ref.	SILCA REF.  "TE" Silca Ref.	 SILCA REF.  "Flip Keys" Silca Ref.	COPY 	GEN. 	TRANSP. TYPE 	ID  FAST COPY PLUS RW4 PLUS FAST COPY/RW4	COPY  FAST COPY PLUS RW4 PLUS	COPY  FAST COPY RW4	STP   		
MERCURY®														
MOUNTAINEER	2001	2011	FO38RMH	FO38RTE	FO38RFH*	Y	Y	TEX/CR	63	Y	P-BOX			
MYSTIQUE V6 LS	1997	2002	FO26MH	FO26TE	FO26FH*	Y	Y	TEXAS	4C	Y	P-BOX			
SABLE GS	1999	2000	FO38RMH	FO38RTE	FO38RFH*	Y	Y	TEXAS	4C	Y	P-BOX			
SABLE GS, LS	2000	2007	FO38RMH	FO38RTE	FO38RFH*	Y	Y	TEX/CR	63	Y	P-BOX			
SABLE LS, SE, SHO	1996	2000	FO38RMH	FO38RTE	FO38RFH*	Y	Y	TEXAS	4C	Y	P-BOX			
MINI®														
380	2006		MIT11RMH	MIT11RTE	MIT11RFH*	Y	Y	PH/CR2	46	Y	P-BOX			
CARISMA	1996	2000	HU56RT2		HU56RFH*			PH	73	Y	Y			
CARISMA	2000	2004	HU56RT30		HU56RFH*			PH/CR	4M					
CHALLENGER	1999	2002	MIT8MH	MIT8TE	MIT8FH*	Y	Y	TEX/CR	60	Y	P-BOX			
CHALLENGER	2002	2003	MIT8MH	MIT8TE	MIT8FH*	Y	Y	TEX/CR	62	Y	P-BOX			
COLT	1996	2000	MIT11RMH	MIT11RTE	MIT11RFH*	Y	Y	TEXAS	4C	Y	P-BOX			
COLT	2004		HU56RMH		HU56RFH*	Y	Y	PH/CR2	46	Y	P-BOX			
DIAMANTE	2002	2006	MIT8MH	MIT8TE	MIT8FH*	Y	Y	TEX/CR	61	Y	P-BOX			
ECLIPSE	1996	2000	MIT8MH	MIT8TE	MIT8FH*	Y	Y	TEXAS	4C	Y	P-BOX			
ECLIPSE	2001	2005	MIT8MH	MIT8TE	MIT8FH*	Y	Y	TEX/CR	61	Y	P-BOX			
ECLIPSE	2008	2012	MIT11RMH	MIT11RTE	MIT11RFH*	Y	Y	PH/CR2	46	Y	P-BOX			
ENDEAVOR	2007	2011	MIT11RMH	MIT11RTE	MIT11RFH*	Y	Y	PH/CR2	46	Y	P-BOX			
EXPRESS	1996		MIT8MH	MIT8TE	MIT8FH*	Y	Y	TEXAS	4C	Y	P-BOX			
FOCUS	1998		MIT8MH	MIT8TE	MIT8FH*	Y	Y	TEXAS	4C	Y	P-BOX			
GALANT	1996	2000	MIT8MH	MIT8TE	MIT8FH*	Y	Y	TEXAS	4C	Y	P-BOX			
GALANT	2002	2005	MIT8MH	MIT8TE	MIT8FH*	Y	Y	TEX/CR	61	Y	P-BOX			
GALANT	2006		MIT11RMH	MIT11RTE	MIT11RFH*	Y	Y	PH/CR2	46	Y	P-BOX			
GALANT (USA)	2008	2012	MIT11RMH	MIT11RTE	MIT11RFH*	Y	Y	PH/CR2	46	Y	P-BOX			
GRANDIS	2003		MIT11RMH	MIT11RTE	MIT11RFH*	Y	Y	PH/CR2	46	Y	P-BOX			
I-MIEV	2010		MIT11RMH	MIT11RTE	MIT11RFH*	Y	Y	PH/CR2	46	Y	P-BOX			
L200	2002	2006	MIT8MH	MIT8TE	MIT8FH*	Y	Y	TEX/CR	61	Y	P-BOX			
L200	2006		MIT8MH	MIT8TE	MIT8FH*	Y	Y	PH/CR2	46	Y	P-BOX			
LANCER	1996	2003	MIT11RMH	MIT11RTE	MIT11RFH*	Y	Y	TEXAS	4C	Y	P-BOX			
LANCER	2003	2006	MIT11RMH	MIT11RTE	MIT11RFH*	Y	Y	TEX/CR	61	Y	P-BOX			
LANCER	2006		MIT11RMH	MIT11RTE	MIT11RFH*	Y	Y	PH/CR2	46	Y	P-BOX			
LANCER SW	1996	2003	MIT11RMH	MIT11RTE	MIT11RFH*	Y	Y	TEXAS	4C	Y	P-BOX			
MAGNA	1999	2005	TOY40MH	TOY40BTE	TOY40FH*	Y	Y	PH/CR2	46	Y	P-BOX			
MIRAGE	1996	2002	MIT11RMH	MIT11RTE	MIT11RFH*	Y	Y	TEXAS	4C	Y	P-BOX			
MONTERO	1996	2000	MIT8MH	MIT8TE	MIT8FH*	Y	Y	TEXAS	4C	Y	P-BOX			
MONTERO	2001	2006	MIT8MH	MIT8TE	MIT8FH*	Y	Y	TEX/CR	60	Y	P-BOX			

* Blade for "Flip" Key plastic head

















See info on the uses of the keys on Silca Electronic Keys Catalogue



























1	2	2a	3	3a	3b	E1+E2		6	42+71	72	43 44a	12	15	
						GTI Compatibility								
CAR MAKE/MODEL 	FROM 1995 	TO 2014 	SILCA REF.  Ref.	SILCA REF.  "TE" Silca Ref.	 SILCA REF.  "Flip Keys" Silca Ref.	COPY 	GEN. 	TRANSP. TYPE 	ID  FAST COPY PLUS RW4 PLUS FAST COPY/RW4	COPY  FAST COPY PLUS RW4 PLUS	COPY  FAST COPY RW4	STP  		
mitsubishi®														
MONTERO	2002	2003	MIT8MH	MIT8TE	MIT8FH*	Y	Y	TEX/CR	62	Y	P-BOX			
MONTERO	2002	2005	MIT8MH	MIT8TE	MIT8FH*	Y	Y	TEX/CR	61	Y	P-BOX			
MONTERO IO	2000	2006	MIT11RMH	MIT11RTE	MIT11RFH*	Y	Y	TEX/CR	61	Y	P-BOX			
MONTERO SPORT	2000	2002	MIT8MH	MIT8TE	MIT8FH*	Y	Y	TEX/CR	60	Y	P-BOX			
MONTERO SPORT	2001	2004	MIT8MH	MIT8TE	MIT8FH*	Y	Y	TEX/CR	62	Y	P-BOX			
MONTERO SPORT	2002	2005	MIT8MH	MIT8TE	MIT8FH*	Y	Y	TEX/CR	61	Y	P-BOX			
NIMBUS	1998	1999	MIT8MH	MIT8TE	MIT8FH*	Y	Y	TEXAS	4C	Y	P-BOX			
OUTLANDER	2000	2003	MIT8MH	MIT8TE	MIT8FH*	Y	Y	TEX/CR	60	Y	P-BOX			
OUTLANDER	2004	2006	MIT11RMH	MIT11RTE	MIT11RFH*	Y	Y	TEX/CR	61	Y	P-BOX			
OUTLANDER	2006		MIT11RMH	MIT11RTE	MIT11RFH*	Y	Y	PH/CR2	46	Y	P-BOX			
PAJERO	1996	2000	MIT8MH	MIT8TE	MIT8FH*	Y	Y	TEXAS	4C	Y	P-BOX			
PAJERO	2000	2002	MIT8MH	MIT8TE	MIT8FH*	Y	Y	TEX/CR	60	Y	P-BOX			
PAJERO	2002	2003	MIT8MH	MIT8TE	MIT8FH*	Y	Y	TEX/CR	62	Y	P-BOX			
PAJERO	2002	2005	MIT8MH	MIT8TE	MIT8FH*	Y	Y	TEX/CR	61	Y	P-BOX			
PAJERO	2006		MIT8MH	MIT8TE	MIT8FH*	Y	Y	PH/CR2	46	Y	P-BOX			
PAJERO IO	1999	2004	MIT11RMH	MIT11RTE	MIT11RFH*	Y	Y	TEX/CR	61	Y	P-BOX			
PAJERO MINI [J]	1999		MIT11RMH	MIT11RTE	MIT11RFH*	Y	Y	TEX/CR	62	Y	P-BOX			
PAJERO PININ	1999	2004	MIT11RMH	MIT11RTE	MIT11RFH*	Y	Y	TEX/CR	62	Y	P-BOX			
PAJERO PININ	1999	2004	MIT11RMH	MIT11RTE	MIT11RFH*	Y	Y	TEX/CR	61	Y	P-BOX			
PAJERO SPORT	1999	2002	MIT8MH	MIT8TE	MIT8FH*	Y	Y	TEX/CR	60	Y	P-BOX			
PAJERO SPORT	2002	2003	MIT8MH	MIT8TE	MIT8FH*	Y	Y	TEX/CR	62	Y	P-BOX			
PAJERO SPORT	2002	2006	MIT8MH	MIT8TE	MIT8FH*	Y	Y	TEX/CR	61	Y	P-BOX			
RAIDER	2006	2010	CY24MH		CY24FH*	Y	Y	PH/CR2	46	Y	P-BOX			
SHOGUN	1996	2000	MIT8MH	MIT8TE	MIT8FH*	Y	Y	TEXAS	4C	Y	P-BOX			
SHOGUN	2000	2002	MIT8MH	MIT8TE	MIT8FH*	Y	Y	TEX/CR	60	Y	P-BOX			
SHOGUN	2002	2003	MIT8MH	MIT8TE	MIT8FH*	Y	Y	TEX/CR	62	Y	P-BOX			
SHOGUN	2002	2005	MIT8MH	MIT8TE	MIT8FH*	Y	Y	TEX/CR	61	Y	P-BOX			
SHOGUN PININ	1999	2004	MIT11RMH	MIT11RTE	MIT11RFH*	Y	Y	TEX/CR	61	Y	P-BOX			
SHOGUN SPORT	1999	2002	MIT8MH	MIT8TE	MIT8FH*	Y	Y	TEX/CR	60	Y	P-BOX			
SHOGUN SPORT	2002	2003	MIT8MH	MIT8TE	MIT8FH*	Y	Y	TEX/CR	62	Y	P-BOX			
SPACE GEAR	1996		MIT8MH	MIT8TE	MIT8FH*	Y	Y	TEXAS	4C	Y	P-BOX			
SPACE RUNNER	1998	1999	MIT8MH	MIT8TE	MIT8FH*	Y	Y	TEXAS	4C	Y	P-BOX			
SPACE STAR	1999	2005	HU56RT30		HU56RFH*			PH/CR	4M					
SPACE WAGON	1998	1999	MIT8MH	MIT8TE	MIT8FH*	Y	Y	TEXAS	4C	Y	P-BOX			
SPACE WAGON	1999	2003	MIT8MH	MIT8TE	MIT8FH*	Y	Y	TEX/CR	60	Y	P-BOX			
VERADA	2002	2003	MIT8MH	MIT8TE	MIT8FH*	Y	Y	TEX/CR	61	Y	P-BOX			
VERADA (AUS)	2000	2002	TOY40MH	TOY40BTE	TOY40FH*	Y	Y	PH/CR2	46	Y	P-BOX			

* Blade for "Flip" Key plastic head

See info on the uses of the keys on Silca Electronic Keys Catalogue 

1	2	2a	3	3a	3b	E1+E2		6	42+71	72	43 44a	12	15	
						GTI Compatibility								
CAR MAKE/MODEL 	FROM 1995 	TO 2014 	SILCA REF.  Ref.	SILCA REF.  "TE" Silca Ref.	 SILCA REF.  "Flip Keys" Silca Ref.	COPY 	GEN. 	TRANSP. TYPE 	ID  FAST COPY PLUS RW4 PLUS FAST COPY/RW4	COPY  FAST COPY PLUS RW4 PLUS	COPY  FAST COPY RW4	STP  		
NISSAN®														
ALMERA	1999	2000	NSN14T25		NSN14FH*			PH/CR	41	Y	Y			
ALMERA	2000	2003	NSN14MH	NSN14TE	NSN14FH*	Y	Y	TEX/CR	60	Y	P-BOX			
ALMERA	2003	2006	NSN14MH	NSN14TE	NSN14FH*	Y	Y	TEX/CR	XX	Y	P-BOX			
ALMERA TINO	2000	2003	NSN14MH	NSN14TE	NSN14FH*	Y	Y	TEX/CR	60	Y	P-BOX			
ALMERA TINO	2004	2006	NSN14MH	NSN14TE	NSN14FH*	Y		PH/CR2	46	Y	P-BOX			
INTERSTAR	1998	2001	NE73T5		NE73FH*			PH	33	Y	Y			
INTERSTAR	2002	2010	NE72MH	NE72ATE	NE72FH*	Y	Y	PH/CR2	46	Y	P-BOX			
INTERSTAR	2002	2010	NE73MH	NE73TE	NE73FH*	Y	Y	PH/CR2	46	Y	P-BOX			
JUKE	2010		NSN14MH	NSN14TE	NSN14FH*	Y		PH/CR2	46	Y	P-BOX			
MAXIMA	1995	1999	NSN11T2		NSN11FH*			PH	33	Y	Y	N-N		
MAXIMA	2000	2003	NSN11T25		NSN11FH*			PH/CR	41	Y	Y			
MICRA	1996	1998	NSN11T2		NSN11FH*			PH	33	Y	Y	N-N		
MICRA	1998	2000	NSN11T25		NSN11FH*			PH/CR	41	Y	Y			
MICRA	2000	2003	NSN11MH	NSN11TE	NSN11FH*	Y	Y	TEX/CR	60	Y	P-BOX			
MICRA	2003		NSN14MH	NSN14TE	NSN14FH*	Y		PH/CR2	46	Y	P-BOX			
MICRA MARCH [J]	1996	1998	NSN11T2		NSN11FH*			PH	33	Y	Y	N-N		
MICRA MARCH [J]	1998	2000	NSN11T25		NSN11FH*			PH/CR	41	Y	Y			
MICRA MARCH [J]	2000	2003	NSN11MH	NSN11TE	NSN11FH*	Y	Y	TEX/CR	60	Y	P-BOX			
MICRA VAN	1998	2000	NSN11T25		NSN11FH*			PH/CR	41	Y	Y			
MICRA VAN	2000	2003	NSN11MH	NSN11TE	NSN11FH*	Y	Y	TEX/CR	60	Y	P-BOX			
MURANO	2003	2007	NSN14MH	NSN14TE	NSN14FH*	Y	Y	TEX/CR	XX	Y	P-BOX			
NAVARA	2000	2003	NSN14T25		NSN14FH*			PH/CR	41	Y	Y			
NAVARA	2003	2005	NSN14MH	NSN14TE	NSN14FH*	Y	Y	TEX/CR	60	Y	P-BOX			
NAVARA	2003	2005	NSN14MH	NSN14TE	NSN14FH*	Y	Y	TEX/CR	XX	Y	P-BOX			
NAVARA	2005		NSN14MH	NSN14TE	NSN14FH*	Y		PH/CR2	46	Y	P-BOX			
NOTE	2006		NSN14MH	NSN14TE	NSN14FH*	Y		PH/CR2	46	Y	P-BOX			
NP300	2010		NSN14MH	NSN14TE	NSN14FH*	Y		PH/CR2	46	Y	P-BOX			
NV400	2011		VA6MH		VA6FH*	Y	Y	PH/CR2	46	Y	P-BOX			
NX ALMERA	1995	1998	NSN11T2		NSN11FH*			PH	33	Y	Y	N-N		
NX ALMERA	1998	2000	NSN11T25		NSN11FH*			PH/CR	41	Y	Y			
PATHFINDER	2005		NSN14MH	NSN14TE	NSN14FH*	Y		PH/CR2	46	Y	P-BOX			
PATROL	1998	2003	NSN14T25		NSN14FH*			PH/CR	41	Y	Y			
PATROL	2004		NSN14MH	NSN14TE	NSN14FH*	Y	Y	TEX/CR	XX	Y	P-BOX			
PIXO	2009		HU133RMH	HU133RTE	HU133RFH*	Y	Y	PH/CR2	46	Y	P-BOX			
PRIMASTAR	2003		NE72MH	NE72ATE	NE72FH*	Y	Y	PH/CR2	46	Y	P-BOX			
PRIMERA	1995	1996	NSN11T2		NSN11FH*			PH	33	Y	Y	N-N		











1	2	2a	3	3a	3b	E1+E2		6	42+71	72	43 44a	12	15	
						GTI Compatibility								
CAR MAKE/MODEL 	FROM 1995	TO 2014	SILCA REF.  Ref.	SILCA REF.  "TE" Silca Ref.	 SILCA REF.  "Flip Keys" Silca Ref.	COPY 	GEN. 	TRANSP. TYPE 	ID  FAST COPY PLUS RW4 PLUS FAST COPY/RW4	COPY  FAST COPY PLUS RW4 PLUS	COPY  FAST COPY RW4	STP  		
NISSAN®														
PRIMERA	1997	1998	NSN14T5		NSN14FH*			PH	33	Y	Y	N-N		
PRIMERA	1998	2000	NSN14MH	NSN14TE	NSN14FH*	Y	Y	TEX/CR	60	Y	P-BOX			
PRIMERA	2000	2002	NSN14T25		NSN14FH*			PH/CR	41	Y	Y			
PRIMERA	2002	2008	NSN14MH	NSN14TE	NSN14FH*	Y		PH/CR2	46	Y	P-BOX			
PULSAR	1995	1996	NSN11T2		NSN11FH*			PH	33	Y	Y	N-N		
PULSAR	1997	1998	NSN14T5		NSN14FH*			PH	33	Y	Y	N-N		
PULSAR	1998	2000	NSN14MH	NSN14TE	NSN14FH*	Y	Y	TEX/CR	60	Y	P-BOX			
PULSAR	2000	2004	NSN14T25		NSN14FH*			PH/CR	41	Y	Y			
QASHQAI	2007		NSN14MH	NSN14TE	NSN14FH*	Y		PH/CR2	46	Y	P-BOX			
SERENA	1996	1999	NSN11T2		NSN11FH*			PH	33	Y	Y	N-N		
SUNNY [J]	1996	1998	NSN11T2		NSN11FH*			PH	33	Y	Y	N-N		
TERRANO II	1995	1998	NSN11T2		NSN11FH*			PH	33	Y	Y	N-N		
TERRANO II	1998	2001	NSN11T25		NSN11FH*			PH/CR	41	Y	Y			
TERRANO II	2002	2006	NSN11MH	NSN11TE	NSN11FH*	Y	Y	TEX/CR	60	Y	P-BOX			
VANETTE	2000		NSN11MH	NSN11TE	NSN11FH*	Y	Y	TEX/CR	60	Y	P-BOX			
VANETTE CARGO	1996	1999	NSN11T2		NSN11FH*			PH	33	Y	Y	N-N		
VANETTE CARGO	1999	2000	NSN11T25		NSN11FH*			PH/CR	41	Y	Y			
VANETTE CARGO	2000		NSN11MH	NSN11TE	NSN11FH*	Y	Y	TEX/CR	60	Y	P-BOX			
XTERRA	2000	2004	NSN14MH	NSN14TE	NSN14FH*	Y	Y	TEX/CR	60	Y	P-BOX			
X-TRAIL	2001	2003	NSN14MH	NSN14TE	NSN14FH*	Y	Y	TEX/CR	60	Y	P-BOX			
X-TRAIL	2004		NSN14MH	NSN14TE	NSN14FH*	Y	Y	TEX/CR	XX	Y	P-BOX			
X-TRAIL [J]	1998	2000	NSN14T25		NSN14FH*			PH/CR	41	Y	Y			
NISSAN USA®														
350Z	2003	2009	NSN14MH	NSN14TE	NSN14FH*	Y	Y	PH/CR2	46	Y	P-BOX			
ALTIMA	2005	2006	NSN14MH	NSN14TE	NSN14FH*	Y	Y	PH/CR2	46	Y	P-BOX			
ARMADA	2004		NSN14MH	NSN14TE	NSN14FH*	Y	Y	PH/CR2	46	Y	P-BOX			
CUBE	2009		NSN14MH	NSN14TE	NSN14FH*	Y	Y	PH/CR2	46	Y	P-BOX			
FRONTIER	2002	2005	NSN14MH	NSN14TE	NSN14FH*	Y	Y	TEX/CR	60	Y	P-BOX			
FRONTIER	2005		NSN14MH	NSN14TE	NSN14FH*	Y	Y	PH/CR2	46	Y	P-BOX			
JUKE	2011		NSN14MH	NSN14TE	NSN14FH*	Y	Y	PH/CR2	46	Y	P-BOX			
LIVINA	2007		NSN14MH	NSN14TE	NSN14FH*	Y	Y	PH/CR2	46	Y	P-BOX			
MAXIMA	1995	2000	NSN11T2		NSN11FH*			PH	33	Y	Y	N-N		
MAXIMA	2000	2003	NSN14MH	NSN14TE	NSN14FH*	Y	Y	TEX/CR	60	Y	P-BOX			
MAXIMA	2004	2007	NSN14MH	NSN14TE	NSN14FH*	Y	Y	PH/CR2	46	Y	P-BOX			
MURANO	2003	2008	NSN14MH	NSN14TE	NSN14FH*	Y	Y	PH/CR2	46	Y	P-BOX			
NV SERIES	2012		NSN14MH	NSN14TE	NSN14FH*	Y	Y	PH/CR2	46	Y	P-BOX			

















1	2	2a	3	3a	3b	E1+E2		6	42+71	72	43 44a	12	15
CAR MAKE/MODEL 	FROM	TO	SILCA REF.	SILCA REF.	SILCA REF.	COPY	GEN.	TRANSP. TYPE 	ID  FAST COPY PLUS RW4 PLUS FAST COPY/RW4	COPY  FAST COPY PLUS RW4 PLUS	COPY  FAST COPY RW4	STP 	
	1995	2014	 Ref.	 "TE" Silca Ref.	 "Flip Keys" Silca Ref.								
NISSAN USA®													
PATHFINDER	2005		NSN14MH	NSN14TE	NSN14FH*	Y	Y	PH/CR2	46	Y	P-BOX		
QUEST	2004	2010	NSN14MH	NSN14TE	NSN14FH*	Y	Y	PH/CR2	46	Y	P-BOX		
ROGUE	2007		NSN14MH	NSN14TE	NSN14FH*	Y	Y	PH/CR2	46	Y	P-BOX		
SENTRA	2007		NSN14MH	NSN14TE	NSN14FH*	Y	Y	PH/CR2	46	Y	P-BOX		
TIIDA	2007		NSN14MH	NSN14TE	NSN14FH*	Y	Y	PH/CR2	46	Y	P-BOX		
TITAN	2004		NSN14MH	NSN14TE	NSN14FH*	Y	Y	PH/CR2	46	Y	P-BOX		
VERSA	2007		NSN14MH	NSN14TE	NSN14FH*	Y	Y	PH/CR2	46	Y	P-BOX		
XTERRA	2005	2012	NSN14MH	NSN14TE	NSN14FH*	Y	Y	PH/CR2	46	Y	P-BOX		
X-TRAIL	2005	2006	NSN14MH	NSN14TE	NSN14FH*	Y	Y	TEX/CR	60	Y	P-BOX		
OPEL-VAUXHALL®													
ADAM	2013		HU100MH	HU100TE	HU100FH*	Y		PH/CR2	46	Y	P-BOX		
AGILA	2000	2000	HU87RT5		HU87RFH*			PH/CR	40	RD	RD		
AGILA	2000	2004	HU87RT12		HU87RFH*			PH/CR	40				
AGILA	2004	2008	HU100T12		HU100FH*			PH/CR	40				
AGILA	2008		HU133RMH	HU133RTE	HU133RFH*	Y	Y	PH/CR2	46	Y	P-BOX		
AGILA DIESEL	2008		HU133RT12		HU133RFH*			PH/CR	40				
AMPERA	2012		HU100MH	HU100TE	HU100FH*	Y		PH/CR2	46	Y	P-BOX		
ANTARA	2007		DWO5MH		DWO5FH**	Y		PH/CR2	46	Y	P-BOX		
ASTRA	2004		HU100MH	HU100TE	HU100FH*	Y		PH/CR2	46	Y	P-BOX		
CABRIO	2013		HU100MH	HU100TE	HU100FH*	Y		PH/CR2	46	Y	P-BOX		
CALIBRA	1995	1998	HU43T2		HU43FH*			PH	33	Y	Y	S-O	
CASCADA	2013		HU100MH	HU100TE	HU100FH*	Y		PH/CR2	46	Y	P-BOX		
COMBO	1998	2002	NE73T5		NE73FH*			PH	33	Y	Y	S-O	
CORSA	2004	2006	HU100T12		HU100FH*			PH/CR	40				
CORSA	2006		HU100MH	HU100TE	HU100FH*	Y	Y	PH/CR2	46	Y	P-BOX		
FRONTERA	1999	2003	HON58RT6		HON58RFH*			MEG/CR	48				
INSIGNA	2008		HU100MH	HU100TE	HU100FH*	Y		PH/CR2	46	Y	P-BOX		
MERIVA	2004	2010	HU100T12		HU100FH*			PH/CR	40				
MERIVA	2010		HU100MH	HU100TE	HU100FH*	Y		PH/CR2	46	Y	P-BOX		
MOKKA	2012		HU100MH	HU100TE	HU100FH*	Y		PH/CR2	46	Y	P-BOX		
MOVANO	1998	2001	NE73T5		NE73FH*			PH	33	Y	Y	S-O	
MOVANO	2002	2010	NE72MH	NE72ATE	NE72FH*	Y	Y	PH/CR2	46	Y	P-BOX		
MOVANO	2002	2010	NE73MH	NE73TE	NE73FH*	Y	Y	PH/CR2	46	Y	P-BOX		
MOVANO	2011		VA6MH		VA6FH*	Y		PH/CR2	46	Y	P-BOX		
OMEGA	1995	1998	HU43T2		HU43FH*			PH	33	Y	Y	S-O	
SIGNUM	2003	2005	HU43MH		HU43FH*	Y		PH/CR2	46	Y	P-BOX		

* Blade for "Flip" Key plastic head

See info on the uses of the keys on Silca Electronic Keys Catalogue













1	2	2a	3	3a	3b	E1+E2		6	42+71	72	43 44a	12	15
CAR MAKE/MODEL 	FROM	TO	SILCA REF.	SILCA REF.	SILCA REF.	COPY	GEN.	TRANSP. TYPE 	ID  FAST COPY PLUS RW4 PLUS FAST COPY/RW4	COPY  FAST COPY PLUS RW4 PLUS	COPY  FAST COPY RW4	STP 	
	1995	2014	 Ref.	 "TE" Silca Ref.	 "Flip Keys" Silca Ref.								
OPEL-VAUXHALL®													
SIGNUM	2003	2008	HU100MH	HU100TE	HU100FH*	Y		PH/CR2	46	Y	P-BOX		
SINTRA	1997	1999	HU43T2		HU43FH*			PH	33	Y	Y	S-O	
TIGRA	2004	2009	HU100T12		HU100FH*			PH/CR	40				
VECTRA	1995	1998	HU43T2		HU43FH*			PH	33	Y	Y	S-O	
VECTRA	1998	2000	HU43T2		HU43FH*			PH/CR	40	RD	RD		
VECTRA	1998	2001	HU43T9		HU43FH*			PH/CR	40				
VECTRA	2002	2005	HU43MH		HU43FH*	Y		PH/CR2	46	Y	P-BOX		
VECTRA	2004	2008	HU100MH	HU100TE	HU100FH*	Y		PH/CR2	46	Y	P-BOX		
VIVARO	2002		NE72MH	NE72ATE	NE72FH*	Y	Y	PH/CR2	46	Y	P-BOX		
ZAFIRA	1999	2001	HU43T2		HU43FH*			PH/CR	40	RD	RD		
ZAFIRA	1999	2001	HU43T9		HU43FH*			PH/CR	40				
ZAFIRA	2006		HU100MH	HU100TE	HU100FH*	Y		PH/CR2	46	Y	P-BOX		
PEUGEOT®													
106	1997	2000	NE72AT5		NE72FH*			PH	33	Y	Y	G-V	
106	2000	2004	NE73MH	NE73TE	NE73FH*	Y	Y	PH/CR2	46	Y	P-BOX		
107	2005		VA6MH		VA6FH*	Y	Y	TEX/CR	70	Y	P-BOX		
206	1998	2001	NE72AT29		NE72FH*			PH/CR	45	Y	Y		
206	2001	2009	NE73MH	NE73TE	NE73FH*	Y	Y	PH/CR2	46	Y	P-BOX		
207	2006		HU83MH	HU83TE	HU83FH*	Y	Y	PH/CR2	46	Y	P-BOX		
208	2012		HU83MH	HU83TE	HU83FH*	Y	Y	PH/CR2	46	Y	P-BOX		
307	2001	2009	HU83MH	HU83TE	HU83FH*	Y	Y	PH/CR2	46	Y	P-BOX		
308	2007		HU83MH	HU83TE	HU83FH*	Y	Y	PH/CR2	46	Y	P-BOX		
407	2004	2011	VA6MH		VA6FH*	Y	Y	PH/CR2	46	Y	P-BOX		
508	2011		VA6MH		VA6FH*	Y		PH/CR2	46	Y	P-BOX		
807	2002		HU83MH	HU83TE	HU83FH*	Y	Y	PH/CR2	46	Y	P-BOX		
1007	2004	2010	VA6MH		VA6FH*	Y	Y	PH/CR2	46	Y	P-BOX		
2008	2013		HU83MH	HU83TE	HU83FH*	Y	Y	PH/CR2	46	Y	P-BOX		
3008	2009		HU83MH	HU83TE	HU83FH*	Y	Y	PH/CR2	46	Y	P-BOX		
4007	2007		MIT11RMH	MIT11RTE	MIT11RFH*	Y	Y	PH/CR2	46	Y	P-BOX		
5008	2009		HU83MH	HU83TE	HU83FH*	Y	Y	PH/CR2	46	Y	P-BOX		
206 CABRIO	2001	2002	NE72AT29		NE72FH*			PH/CR	45	Y	Y		
206 CABRIO	2002	2007	NE73MH	NE73TE	NE73FH*	Y	Y	PH/CR2	46	Y	P-BOX		
206 PLUS	2009		NE73MH	NE73TE	NE73FH*	Y	Y	PH/CR2	46	Y	P-BOX		
306 [SB]	1997	2002	NE72AT5		NE72FH*			PH	33	Y	Y	G-C	
306 [SC]	1997	2002	NE72AT5		NE72FH*			PH	33	Y	Y	G-C	
BIPPER	2009		SIP22MH	SIP22TE	SIP22FH*	Y		PH/CR2	46	Y	P-BOX		











1	2	2a	3	3a	3b	E1+E2		6	42+71	72	43 44a	12	15	
						GTI Compatibility								
CAR MAKE/MODEL 	FROM 1995 	TO 2014 	SILCA REF.  Ref.	SILCA REF.  "TE" Silca Ref.	 SILCA REF.  "Flip Keys" Silca Ref.	COPY 	GEN. 	TRANSP. TYPE 	ID  FAST COPY PLUS RW4 PLUS FAST COPY/RW4	COPY  FAST COPY PLUS RW4 PLUS	COPY  FAST COPY RW4	STP  		
PEUGEOT®														
BOXER	1996	2001	GT10BT5		GT10FH*			MEG	13	Y	Y	MEG	S1	
BOXER	2006		SIP36MH	SIP22TE	SIP22FH*	Y	Y	PH/CR2	46	Y		P-BOX		
EXPERT	2007		HU83MH	HU83TE	HU83FH*	Y	Y	PH/CR2	46	Y		P-BOX		
ION	2011		MIT11RMH	MIT11RTE	MIT11RFH*	Y	Y	PH/CR2	46	Y		P-BOX		
PARTNER	2002		VA6MH		VA6FH*	Y	Y	PH/CR2	46	Y		P-BOX		
RANCH	2002	2007	VA6MH		VA6FH*	Y	Y	PH/CR2	46	Y		P-BOX		
RCZ	2010		HU83MH	HU83TE	HU83FH*	Y	Y	PH/CR2	46	Y		P-BOX		
PLYMOUTH®														
BREEZE	1999	2001	CY24MH		CY24FH*	Y	Y	TEX/CR	64	Y		P-BOX		
NEON	2000	2001	CY24MH		CY24FH*	Y	Y	TEX/CR	64	Y		P-BOX		
PROWLER	2000	2002	CY24MH		CY24FH*	Y	Y	TEX/CR	64	Y		P-BOX		
PONTIAC®														
G3	2010	2010	DWO4RT6		DWO4RFH*			MEG/CR	48-A					
VIBE	2009	2010	TOY43MH	TOY43ATE	TOY43FH*	Y	Y	TEX/CR	67	Y		P-BOX		
PORSCHE														
911	1998	1999	HU66T5		HU66FH*			MEG	13	Y	Y			
BOXSTER	1997	1998	HU66T5		HU66FH*			MEG	13	Y	Y			
CAYMAN	2009		HU66MH	HU66TE	HU66FH*	Y		PH/CR2	46	Y		P-BOX		
RENAULT®														
AVANTIME	2001	2003	NE73MH	NE73TE	NE73FH*	Y	Y	TEX/CR	60	Y		P-BOX		
CLIO	1995	2001	NE73T5		NE73FH*			PH	33	Y	Y			
CLIO	1995	2001	VAC102T1		VAC102FH*			PH	33	Y	Y			
CLIO II	2001	2012	NE72MH	NE72ATE	NE72FH*	Y		PH/CR2	46	Y		P-BOX		
CLIO III	2006		VA6MH		VA6FH*	Y		PH/CR2	46	Y		P-BOX		
ESPACE III	1997	2002	NE73T5		NE73FH*			PH	33	Y	Y			
KANGOO	1998	2001	VAC102T1		VAC102FH*			PH	33	Y	Y			
KANGOO	2002	2010	VAC102MH	VAC102TE	VAC102FH*	Y	Y	PH/CR2	46	Y		P-BOX		
KANGOO	2011		VA6MH		VA6FH*	Y		PH/CR2	46	Y		P-BOX		
LAGUNA	1995	2000	NE73T5		NE73FH*			PH	33	Y	Y			
LAGUNA	1995	2000	VAC102T1		VAC102FH*			PH	33	Y	Y			
MASTER	1998	2001	NE73T5		NE73FH*			PH	33	Y	Y	S-O		
MASTER	2002	2010	NE72MH	NE72ATE	NE72FH*	Y	Y	PH/CR2	46	Y		P-BOX		
MASTER	2002	2010	NE73MH	NE73TE	NE73FH*	Y	Y	PH/CR2	46	Y		P-BOX		
MASTER	2011		VA6MH		VA6FH*	Y		PH/CR2	46	Y		P-BOX		
MAXITY	2007		NSN19MH	NSN19TE	NSN19FH*	Y		PH/CR2	46	Y		P-BOX		
MEGANE	1996	1998	NE73T5		NE73FH*			PH	33	Y	Y			
MEGANE	1998	2000	NE73MH	NE73TE	NE73FH*	Y	Y	TEX/CR	64	Y		P-BOX		

* Blade for "Flip" Key plastic head

See info on the uses of the keys on Silca Electronic Keys Catalogue













1	2	2a	3	3a	3b	E1+E2		6	42+71	72	43 44a	12	15
CAR MAKE/MODEL 	FROM	TO	SILCA REF.	SILCA REF.	SILCA REF.	COPY	GEN.	TRANSP. TYPE 	ID  FAST COPY PLUS RW4 PLUS FAST COPY/RW4	COPY  FAST COPY PLUS RW4 PLUS	COPY  FAST COPY RW4	STP 	
	1995	2014	 Ref.	 "TE" Silca Ref.	 "Flip Keys" Silca Ref.								
RENAULT®													
MEGANE	2000	2003	NE73MH	NE73TE	NE73FH*	Y	Y	TEX/CR	60	Y	P-BOX		
MODUS	2004		VA6MH		VA6FH*	Y		PH/CR2	46	Y	P-BOX		
SAFRANE	1995	2001	NE73T5		NE73FH*			PH	33	Y	Y		
SAFRANE	1995	2001	VAC102T1		VAC102FH*			PH	33	Y	Y		
THALIA	2001	2008	NE72MH	NE72ATE	NE72FH*	Y		PH/CR2	46	Y	P-BOX		
TRAFIC	2002		NE72MH	NE72ATE	NE72FH*	Y	Y	PH/CR2	46	Y	P-BOX		
TWINGO	1995	2001	VAC102T1		VAC102FH*			PH	33	Y	Y		
TWINGO	2002	2007	VAC102MH	VAC102TE	VAC102FH*	Y	Y	PH/CR2	46	Y	P-BOX		
TWINGO	2007		VA6MH		VA6FH*	Y		PH/CR2	46	Y	P-BOX		
RENAULT-DACIA®													
DOKKER	2012		HU136MH		HU136FH*	Y		PH/CR2	46	Y	P-BOX		
DUSTER	2010		VAC102MH	VAC102TE	VAC102FH*	Y	Y	PH/CR2	46	Y	P-BOX		
LODGY	2012		HU136MH		HU136FH*	Y		PH/CR2	46	Y	P-BOX		
LOGAN	2006		VAC102MH	VAC102TE	VAC102FH*	Y	Y	PH/CR2	46	Y	P-BOX		
SANDERO	2008		VAC102MH	VAC102TE	VAC102FH*	Y	Y	PH/CR2	46	Y	P-BOX		
SANDERO	2010		HU136MH		HU136FH*	Y		PH/CR2	46	Y	P-BOX		
SYMBOL	2010		NE72MH	NE72ATE	NE72FH*	Y		PH/CR2	46	Y	P-BOX		
SATURN (GM)®													
ASTRA	2008	2009	HU100MH	HU100TE	HU100FH*	Y		PH/CR2	46	Y	P-BOX		
VUE	2008	2010	DWO5MH		DWO5FH*	Y		PH/CR2	46	Y	P-BOX		
SCION®													
TC	2005	2010	TOY43MH	TOY43ATE	TOY43FH*	Y	Y	TEX/CR	67	Y	P-BOX		
XA	2004	2007	TOY43MH	TOY43ATE	TOY43FH*	Y	Y	TEX/CR	67	Y	P-BOX		
XB	2004	2008	TOY43MH	TOY43ATE	TOY43FH*	Y		TEX/CR	XX	Y	P-BOX		
XD	2008	2012	TOY43MH	TOY43ATE	TOY43FH*	Y		TEX/CR	67	Y	P-BOX		
SEAT®													
ALHAMBRA	1996	1998	HU66T5		HU66FH*			PH	33	Y	Y	S-V	
ALHAMBRA	1998	2000	HU66T10		HU66FH*			PH/CR	42	Y	Y		
ALHAMBRA	2000	2005	HU66T28		HU66FH*			PH/CR	4W	RD	RD		
ALHAMBRA	2006	2010	HU66T6		HU66FH*			MEG/CR	48				
ALTEA	2004	2005	HU66T6		HU66FH*			MEG/CR	48				
ALTEA	2004	2008	HU66T23		HU66FH*			MEG/CR	A3				
ALTEA XL	2006	2008	HU66T23		HU66FH*			MEG/CR	A3				
AROSA	1997	1999	HU66T5		HU66FH*			PH	33	Y	Y	S-V	
AROSA	1999	2001	HU66T10		HU66FH*			PH/CR	42	Y	Y		
AROSA	2001	2005	HU66T28		HU66FH*			PH/CR	4W	RD	RD		

1	2	2a	3	3a	3b	E1+E2		6	42+71	72	43 44a	12	15	
CAR MAKE/MODEL 	FROM	TO	SILCA REF.	SILCA REF.	SILCA REF.	COPY	GEN.	TRANSP. TYPE 	ID  FAST COPY PLUS RW4 PLUS FAST COPY/RW4	COPY  FAST COPY PLUS RW4 PLUS	COPY  FAST COPY RW4	STP  	IGNITION 	
	1995	2014	 Ref.	 "TE" Silca Ref.	 "Flip Keys" Silca Ref.								GTI Compatibility	
SEAT®														
CORDOBA	1999	2002	HU66T10		HU66FH*			PH/CR	42	Y	Y			
CORDOBA	2002	2009	HU66T6		HU66FH*			MEG/CR	48					
IBIZA	1998	2002	HU66T10		HU66FH*			PH/CR	42	Y	Y			
IBIZA	2002	2009	HU66T6		HU66FH*			MEG/CR	48					
INCA	1998	2000	HU66T10		HU66FH*			PH/CR	42	Y	Y			
INCA	2000	2003	HU66T28		HU66FH*			PH/CR	4W	RD	RD			
LEON	2000	2005	HU66T6		HU66FH*			MEG/CR	48					
LEON	2005	2008	HU66T23		HU66FH*			MEG/CR	A3					
TOLEDO	1997	1999	HU66T5		HU66FH*			MEG	13	Y	Y			
TOLEDO	2000	2004	HU66T6		HU66FH*			MEG/CR	48					
TOLEDO	2005	2008	HU66T23		HU66FH*			MEG/CR	A3					
SKODA®														
FABIA	2000	2006	HU66AT6		HU66FH*			MEG/CR	48					
FELICIA	1998	2001	HU66AT5		HU66FH*			PH	33	Y	Y	S-V		
FELICIA	1998	2001	HU66CT5		HU66FH*			PH	33	Y	Y	S-V		
FELICIA	1999	2001	HU66AT6		HU66FH*			MEG/CR	48					
OCTAVIA	1997	2001	HU66AT5		HU66FH*			MEG	13	Y	Y	MEG		
OCTAVIA	1997	2001	HU66CT5		HU66FH*			MEG	13	Y	Y	MEG		
OCTAVIA	2001	2004	HU66T6		HU66FH*			MEG/CR	48					
OCTAVIA	2004	2006	HU66T26		HU66FH*			MEG/CR	A4					
PICK-UP	1998	2000	HU66AT5		HU66FH*			PH	33	Y	Y	S-V		
ROOMSTER	2006	2008	HU66T26		HU66FH*			MEG/CR	A4					
ROOMSTER SCOUT	2007	2008	HU66T26		HU66FH*			MEG/CR	A4					
SUPERB	2002	2007	HU66T6		HU66FH*			MEG/CR	48					
SMART®														
FORFOUR	2004	2006	HU56RMH		HU56RFH*	Y		PH/CR2	46	Y	P-BOX			
SUBARU®														
B9 TRIBECA	2006	2011	NSN19MH	NSN19TE	NSN19FH*	Y	Y	TEX/CR	62	Y	P-BOX			
B9 TRIBECA	2007		DAT17MH		DAT17FH*	Y	Y	TEX/CR	62	Y	P-BOX			
BAJA	2005	2007	NSN19MH	NSN19TE	NSN19FH*	Y	Y	TEX/CR	62	Y	P-BOX			
FORESTER	1998	2003	NSN14MH	NSN14TE	NSN14FH*	Y	Y	TEX/CR	60	Y	P-BOX			
FORESTER	2004	2007	NSN19MH	NSN19TE	NSN19FH*	Y	Y	TEX/CR	62	Y	P-BOX			
FORESTER	2008		DAT17MH		DAT17FH*	Y	Y	TEX/CR	62	Y	P-BOX			
FORESTER (AUS)	1998	2004	NSN19MH	NSN19TE	NSN19FH*	Y	Y	TEX/CR	60	Y	P-BOX			
G3X JUSTY	2004	2007	HU87RMH		HU87RFH*	Y	Y	TEX/CR	65	Y	P-BOX			
IMPREZA	1996	2000	NSN11T2		NSN11FH*			PH	33	Y	Y			

* Blade for "Flip" Key plastic head

















See info on the uses of the keys on Silca Electronic Keys Catalogue



1	2	2a	3	3a	3b	E1+E2		6	42+71	72	43 44a	12	15
CAR MAKE/MODEL 	FROM 1995	TO 2014	SILCA REF.  Ref.	SILCA REF.  "TE" Silca Ref.	SILCA REF.  "Flip Keys" Silca Ref.	COPY	GEN.	TRANSP. TYPE 	ID  FAST COPY PLUS RW4 PLUS FAST COPY/RW4	COPY  FAST COPY PLUS RW4 PLUS	COPY  FAST COPY RW4	STP 	
SUBARU®													
IMPREZA	1998	2003	NSN14MH	NSN14TE	NSN14FH*	Y	Y	TEX/CR	60	Y	P-BOX		
IMPREZA	2004	2007	NSN19MH	NSN19TE	NSN19FH*	Y	Y	TEX/CR	62	Y	P-BOX		
IMPREZA	2007		DAT17MH		DAT17FH*	Y	Y	TEX/CR	62	Y	P-BOX		
IMPREZA (AUS)	1998	2004	NSN19MH	NSN19TE	NSN19FH*	Y	Y	TEX/CR	60	Y	P-BOX		
JUSTY	1996	2003	SZ12MH	SZ12TE	SZ12FH*	Y	Y	TEXAS	4C	Y	P-BOX		
LEGACY	1996	1998	NSN11T2		NSN11FH*			PH	33	Y	Y		
LEGACY	1998	2003	NSN14MH	NSN14TE	NSN14FH*	Y	Y	TEX/CR	60	Y	P-BOX		
LEGACY	2004		DAT17MH		DAT17FH*	Y	Y	TEX/CR	60	Y	P-BOX		
LEGACY	2005		DAT17MH		DAT17FH*	Y	Y	TEX/CR	62	Y	P-BOX		
LIBERTY (AUS)	1998	2003	NSN19MH	NSN19TE	NSN19FH*	Y	Y	TEX/CR	60	Y	P-BOX		
OUTBACK	1996	1998	NSN11T2		NSN11FH*			PH	33	Y	Y		
OUTBACK	1998	2003	NSN14MH	NSN14TE	NSN14FH*	Y	Y	TEX/CR	60	Y	P-BOX		
OUTBACK	2003		DAT17MH		DAT17FH*	Y	Y	TEX/CR	60	Y	P-BOX		
OUTBACK	2005		DAT17MH		DAT17FH*	Y	Y	TEX/CR	62	Y	P-BOX		
OUTBACK (AUS)	1998	2003	NSN19MH	NSN19TE	NSN19FH*	Y	Y	TEX/CR	60	Y	P-BOX		
SOME MODELS	2000		NSN19		NSN19FH*								
SUZUKI®													
ALTO	1996	2002	SZ11RMH	SZ11RTE	SZ11RFH*	Y	Y	TEXAS	4C	Y	P-BOX		
ALTO	1996	2002	SZ12MH	SZ12TE	SZ12FH*	Y	Y	TEXAS	4C	Y	P-BOX		
ALTO	2002	2008	SZ11MH	SZ11TE	SZ11FH*	Y	Y	TEX/CR	65	Y	P-BOX		
ALTO	2002	2008	SZ11RMH	SZ11RTE	SZ11RFH*	Y	Y	TEX/CR	65	Y	P-BOX		
ALTO	2009		HU133RMH	HU133RTE	HU133RFH*	Y	Y	PH/CR2	46	Y	P-BOX		
BALENO	1996	2001	SZ11RMH	SZ11RTE	SZ11RFH*	Y	Y	TEXAS	4C	Y	P-BOX		
BALENO	1996	2001	SZ12MH	SZ12TE	SZ12FH*	Y	Y	TEXAS	4C	Y	P-BOX		
EQUATOR	2009		NSN14MH	NSN14TE	NSN14FH*	Y	Y	PH/CR2	46	Y	P-BOX		
ESCUDO [J]	1996	2002	SZ11RMH	SZ11RTE	SZ11RFH*	Y	Y	TEXAS	4C	Y	P-BOX		
ESCUDO [J]	1996	2002	SZ12MH	SZ12TE	SZ12FH*	Y	Y	TEXAS	4C	Y	P-BOX		
FORENZA	2004	2008	DWO4RAP		DWO4RFH*								
GRAND VITARA	1996	2002	SZ11RMH	SZ11RTE	SZ11RFH*	Y	Y	TEXAS	4C	Y	P-BOX		
GRAND VITARA	1996	2002	SZ12MH	SZ12TE	SZ12FH*	Y	Y	TEXAS	4C	Y	P-BOX		
GRAND VITARA	2002	2008	SZ11RMH	SZ11RTE	SZ11RFH*	Y		PH/CR2	46	Y	P-BOX		
GRAND VITARA	2006	2008	SZ22MH		SZ22FH*	Y		PH/CR2	46	Y	P-BOX		
GRAND VITARA	2008		HU133RMH	HU133RTE	HU133RFH*	Y	Y	PH/CR2	46	Y	P-BOX		
IGNIS	2000	2000	HU87RT5		HU87RFH*			PH/CR	40	RD	RD		
IGNIS	2000	2000	HU87RT9		HU87RFH*			PH/CR	40				
IGNIS	2000	2005	HU87RMH		HU87RFH*	Y	Y	TEX/CR	65	Y	P-BOX		

















* Blade for "Flip" Key plastic head

See info on the uses of the keys on Silca Electronic Keys Catalogue 

1	2	2a	3	3a	3b	E1+E2		6	42+71	72	43 44a	12	15	
						GTI Compatibility								
CAR MAKE/MODEL 	FROM 1995 	TO 2014 	SILCA REF.  Ref.	SILCA REF.  "TE" Silca Ref.	 SILCA REF.  "Flip Keys" Silca Ref.	COPY 	GEN. 	TRANSP. TYPE 	ID  FAST COPY PLUS RW4 PLUS FAST COPY/RW4	COPY  FAST COPY PLUS RW4 PLUS	COPY  FAST COPY RW4	STP  		
SUZUKI®														
IGNIS	2000	2008	SZ11RMH	SZ11RTE	SZ11RFH*	Y	Y	TEX/CR	65	Y	P-BOX			
IGNIS	2003	2008	HU133RMH	HU133RTE	HU133RFH*	Y	Y	TEX/CR	65	Y	P-BOX			
JIMNY	1999	2002	SZ11RMH	SZ11RTE	SZ11RFH*	Y	Y	TEXAS	4C	Y	P-BOX			
JIMNY	2002		HU133RMH	HU133RTE	HU133RFH*	Y	Y	TEX/CR	65	Y	P-BOX			
JIMNY	2002		SZ11RMH	SZ11RTE	SZ11RFH*	Y	Y	TEX/CR	65	Y	P-BOX			
JIMNY DIESEL	2002		HU87RT5		HU87RFH*			PH	33	Y	Y			
JIMNY DIESEL	2002		SZ11RT5	SZ11RTE	SZ11RFH*			PH	33	Y	Y			
LIANA	2001	2005	SZ22MH		SZ22FH*	Y	Y	TEX/CR	65	Y	P-BOX			
LIANA	2006	2007	SZ22MH		SZ22FH*	Y	Y	TEX/CR	66	Y	P-BOX			
RENO	2005	2008	DWO4RAP		DWO4RFH*									
SPLASH	2008		HU133RMH	HU133RTE	HU133RFH*	Y	Y	PH/CR2	46	Y	P-BOX			
SPLASH DIESEL	2008		HU133RT12		HU133RFH*			PH/CR	40					
SWIFT	1996	2005	SZ11RMH	SZ11RTE	SZ11RFH*	Y	Y	TEXAS	4C	Y	P-BOX			
SWIFT	1996	2005	SZ12MH	SZ12TE	SZ12FH*	Y	Y	TEXAS	4C	Y	P-BOX			
SWIFT	2005		HU133RMH	HU133RTE	HU133RFH*	Y	Y	PH/CR2	46	Y	P-BOX			
SWIFT	2005		SZ22MH		SZ22FH*	Y	Y	TEX/CR	66	Y	P-BOX			
SX4	2006		HU133RMH	HU133RTE	HU133RFH*	Y	Y	PH/CR2	46	Y	P-BOX			
SX4 DIESEL	2006		HU133RT12		HU133RFH*			PH/CR	40					
VERONA	2004	2007	DWO5AP		DWO5FH*									
VITARA	1996	2002	SZ11RMH	SZ11RTE	SZ11RFH*	Y	Y	TEXAS	4C	Y	P-BOX			
VITARA	1996	2002	SZ12MH	SZ12TE	SZ12FH*	Y	Y	TEXAS	4C	Y	P-BOX			
VITARA	2002	2008	SZ11RMH	SZ11RTE	SZ11RFH*	Y		PH/CR2	46	Y	P-BOX			
WAGON R	1998	2000	SZ11RMH	SZ11RTE	SZ11RFH*	Y	Y	TEXAS	4C	Y	P-BOX			
WAGON R	2000	2000	HU87RT5		HU87RFH*			PH/CR	40	RD	RD			
WAGON R	2000	2008	HU87RT9		HU87RFH*			PH/CR	40					
TOYOTA®														
4RUNNER	1999	2002	TOY43MH	TOY43ATE	TOY43FH*	Y	Y	TEXAS	4C	Y	P-BOX			
ALPHARD	2005		TOY43MH	TOY43ATE	TOY43FH*	Y	Y	TEX/CR	67	Y	P-BOX			
AURION (AUS)	2006		TOY43MH	TOY43ATE	TOY43FH*	Y	Y	TEX/CR	67	Y	P-BOX			
AURIS	2006		TOY43MH	TOY43ATE	TOY43FH*	Y	Y	TEX/CR	67	Y	P-BOX			
AURIS (EU)	2007		TOY47MH	TOY47TE	TOY47FH*	Y	Y	TEX/CR	70	Y	P-BOX			
AVENSIS	1998	2000	TOY47MH	TOY47TE	TOY47FH*	Y	Y	TEXAS	4C	Y	P-BOX			
AVENSIS	2000	2003	TOY47MH	TOY47TE	TOY47FH*	Y	Y	TEX/CR	60	Y	P-BOX			
AVENSIS	2003		TOY47MH	TOY47TE	TOY47FH*	Y	Y	TEX/CR	70	Y	P-BOX			
AVENSIS VERSO	2001	2003	TOY43MH	TOY43ATE	TOY43FH*	Y	Y	TEXAS	4C	Y	P-BOX			
AYGO	2005		VA6MH		VA6FH*	Y	Y	TEX/CR	70	Y	P-BOX			

















Car Keys Guide / Guida Chiavi Auto / Führer für Autoschlüssel / Guide Clés pour Voitures
 Guía Llaves para Coches / Guia Chaves para Carros

New Updates

1	2	2a	3	3a	3b	E1+E2		6	42+71	72	43 44a	12	15
						GTI Compatibility							
CAR MAKE/MODEL 	FROM 1995 	TO 2014 	SILCA REF.  Ref.	SILCA REF.  "TE" Silca Ref.	 SILCA REF.  "Flip Keys" Silca Ref.	COPY 	GEN. 	TRANSP. TYPE 	ID  FAST COPY PLUS RW4 PLUS FAST COPY/RW4	COPY  FAST COPY PLUS RW4 PLUS	COPY  FAST COPY RW4	STP   	
TOYOTA®													
CAMRY	1996	2005	TOY43MH	TOY43ATE	TOY43FH*	Y	Y	TEXAS	4C	Y	P-BOX		
CAMRY	2006		TOY43MH	TOY43ATE	TOY43FH*	Y	Y	TEX/CR	67	Y	P-BOX		
CARINA	1996	2000	TOY43T2	TOY43TE	TOY43FH*			PH	33	Y	Y		S11
CARINA	1996	2000	TOY47MH	TOY47TE	TOY47FH*	Y	Y	TEXAS	4C	Y	P-BOX		
CELICA	1996	2000	TOY43T2	TOY43TE	TOY43FH*			PH	33	Y	Y		S11
CELICA	2000	2005	TOY43MH	TOY43ATE	TOY43FH*	Y	Y	TEXAS	4C	Y	P-BOX		
CENTURY	1998		TOY40MH	TOY40BTE	TOY40FH*	Y	Y	TEXAS	4C	Y	P-BOX		
COROLLA	1996	2006	TOY43MH	TOY43TE	TOY43FH*	Y	Y	TEXAS	4C	Y	P-BOX		
COROLLA	1999	2006	TOY47MH	TOY47TE	TOY47FH*	Y	Y	TEXAS	4C	Y	P-BOX		
COROLLA	2007		TOY43MH	TOY43ATE	TOY43FH*	Y	Y	TEX/CR	67	Y	P-BOX		
COROLLA (S.AFRICA)	2008		TOY47MH	TOY47TE	TOY47FH*	Y	Y	TEX/CR	70	Y	P-BOX		
ECHO	1999	2005	TOY41RMH	TOY41RATE	TOY41RFH*	Y	Y	TEXAS	4C	Y	P-BOX		
ECHO VERSO	2002	2005	TOY43MH	TOY43ATE	TOY43FH*	Y	Y	TEXAS	4C	Y	P-BOX		
FJ CRUISER	2007		TOY43MH	TOY43ATE	TOY43FH*	Y	Y	TEX/CR	67	Y	P-BOX		
FORTUNER	2007		TOY43MH	TOY43ATE	TOY43FH*	Y	Y	TEX/CR	67	Y	P-BOX		
HIACE	1995	2006	TOY43MH	TOY43ATE	TOY43FH*	Y	Y	TEXAS	4C	Y	P-BOX		
HIACE	2007		TOY43MH	TOY43ATE	TOY43FH*	Y	Y	TEX/CR	67	Y	P-BOX		
HILUX	1999	2004	TOY43MH	TOY43ATE	TOY43FH*	Y	Y	TEXAS	4C	Y	P-BOX		
HILUX	2005		TOY43MH	TOY43ATE	TOY43FH*	Y	Y	TEX/CR	67	Y	P-BOX		
INNOVA KIJANG	2005		TOY43MH	TOY43ATE	TOY43FH*	Y	Y	TEX/CR	67	Y	P-BOX		
IQ	2008		TOY43MH	TOY43ATE	TOY43FH*	Y	Y	TEX/CR	67	Y	P-BOX		
LAND CRUISER 100	1998	2000	TOY40MH	TOY40BTE	TOY40FH*	Y	Y	TEXAS	4C	Y	P-BOX		
LAND CRUISER 100	1998	2002	TOY43MH	TOY43ATE	TOY43FH*	Y	Y	TEXAS	4C	Y	P-BOX		
LAND CRUISER 100	2000	2002	TOY48MH		TOY48FH*	Y	Y	TEXAS	4C	Y	P-BOX		
LAND CRUISER 100	2003	2008	TOY43MH	TOY43ATE	TOY43FH*	Y	Y	TEX/CR	67	Y	P-BOX		
LAND CRUISER 100 (AUS)	2003		TOY48MH		TOY48FH*	Y		TEX/CR	60	Y	P-BOX		
LAND CRUISER 120	2002		TOY43MH	TOY43ATE	TOY43FH*	Y	Y	TEX/CR	67	Y	P-BOX		
LAND CRUISER 90	1996	2002	TOY43MH	TOY43ATE	TOY43FH*	Y	Y	TEXAS	4C	Y	P-BOX		
LAND CRUISER PRADO	2002		TOY43MH	TOY43ATE	TOY43FH*	Y	Y	TEX/CR	67	Y	P-BOX		
MR2	1997	2007	TOY41RMH	TOY41RTE	TOY41RFH*	Y	Y	TEXAS	4C	Y	P-BOX		
PICNIC	1996	2003	TOY43MH	TOY43ATE	TOY43FH*	Y	Y	TEXAS	4C	Y	P-BOX		
PICNIC	2003	2008	TOY43MH	TOY43ATE	TOY43FH*	Y	Y	TEX/CR	67	Y	P-BOX		
PREVIA	2000	2003	TOY43MH	TOY43ATE	TOY43FH*	Y	Y	TEXAS	4C	Y	P-BOX		
PREVIA	2003	2008	TOY43MH	TOY43ATE	TOY43FH*	Y	Y	TEX/CR	67	Y	P-BOX		
PRIUS	2000	2003	TOY43MH	TOY43ATE	TOY43FH*	Y	Y	TEXAS	4C	Y	P-BOX		
RAV 4	1996	2004	TOY43MH	TOY43TE	TOY43FH*	Y	Y	TEXAS	4C	Y	P-BOX		

* Blade for "Flip" Key plastic head

















See info on the uses of the keys on Silca Electronic Keys Catalogue 

1	2	2a	3	3a	3b	E1+E2		6	42+71	72	43 44a	12	15
						GTI Compatibility							
CAR MAKE/MODEL 	FROM 1995 	TO 2014 	SILCA REF.  Ref.	SILCA REF.  "TE" Silca Ref.	 SILCA REF.  "Flip Keys" Silca Ref.	COPY 	GEN. 	TRANSP. TYPE 	ID  FAST COPY PLUS RW4 PLUS FAST COPY/RW4	COPY  FAST COPY PLUS RW4 PLUS	COPY  FAST COPY RW4	STP   	
TOYOTA®													
RAV 4	2005		TOY43MH	TOY43ATE	TOY43FH*	Y	Y	TEX/CR	67	Y	P-BOX		
REIZ	2005		TOY43MH	TOY43ATE	TOY43FH*	Y	Y	TEX/CR	67	Y	P-BOX		
STARLET	1997	1999	TOY41RAT5	TOY41RATE	TOY41RFH*			PH	33	Y	Y		S11
T.U.V.	2003		TOY43MH	TOY43ATE	TOY43FH*	Y	Y	TEX/CR	67	Y	P-BOX		
TARAGO	2003	2008	TOY43MH	TOY43ATE	TOY43FH*	Y	Y	TEX/CR	67	Y	P-BOX		
VIOS	2007		TOY43MH	TOY43ATE	TOY43FH*	Y	Y	TEX/CR	67	Y	P-BOX		
WISH	2004		TOY43MH	TOY43ATE	TOY43FH*	Y	Y	TEX/CR	67	Y	P-BOX		
YARIS	1999	2005	TOY41RMH	TOY41RTE	TOY41RFH*	Y	Y	TEXAS	4C	Y	P-BOX		
YARIS	1999	2005	TOY47MH	TOY47TE	TOY47FH*	Y	Y	TEXAS	4C	Y	P-BOX		
YARIS	2005	2011	TOY47MH	TOY47TE	TOY47FH*	Y	Y	TEX/CR	70	Y	P-BOX		
TOYOTA JAPAN													
ALPHARD	2003		TOY43MH	TOY43ATE	TOY43FH*	Y	Y	TEX/CR	67	Y	P-BOX		
ARISTO	1998	2005	TOY48MH		TOY48FH*	Y	Y	TEXAS	4C	Y	P-BOX		
BB	2000	2005	TOY43MH	TOY43ATE	TOY43FH*	Y	Y	TEX/CR	67	Y	P-BOX		
BREVIS	2001	2007	TOY48MH		TOY48FH*	Y	Y	TEXAS	4C	Y	P-BOX		
CALDINA	2002	2004	TOY43MH	TOY43ATE	TOY43FH*	Y	Y	TEXAS	4C	Y	P-BOX		
CELSIOR	1998	2004	TOY40MH	TOY40BTE	TOY40FH*	Y	Y	TEXAS	4C	Y	P-BOX		
CELSIOR	1998	2004	TOY48MH		TOY48FH*	Y	Y	TEXAS	4C	Y	P-BOX		
COROLLA FIELDER	2004		TOY43MH	TOY43ATE	TOY43FH*	Y	Y	TEX/CR	67	Y	P-BOX		
COROLLA RUNX	2004		TOY43MH	TOY43ATE	TOY43FH*	Y	Y	TEX/CR	67	Y	P-BOX		
COROLLA SPACIO	2003		TOY43MH	TOY43ATE	TOY43FH*	Y	Y	TEX/CR	67	Y	P-BOX		
CROWN	1999	2005	TOY48MH		TOY48FH*	Y	Y	TEXAS	4C	Y	P-BOX		
DYNA	2008		TOY43MH	TOY43ATE	TOY43FH*	Y	Y	TEX/CR	67	Y	P-BOX		
ESTIMA	2001	2003	TOY43MH	TOY43ATE	TOY43FH*	Y	Y	TEXAS	4C	Y	P-BOX		
ESTIMA	2003		TOY43MH	TOY43ATE	TOY43FH*	Y	Y	TEX/CR	67	Y	P-BOX		
FUN CARGO	2003	2005	TOY43MH	TOY43ATE	TOY43FH*	Y	Y	TEX/CR	67	Y	P-BOX		
GAIA	1999	2004	TOY43MH	TOY43ATE	TOY43FH*	Y	Y	TEXAS	4C	Y	P-BOX		
IPSUM	1996	2003	TOY43MH	TOY43ATE	TOY43FH*	Y	Y	TEXAS	4C	Y	P-BOX		
IPSUM	2003		TOY43MH	TOY43ATE	TOY43FH*	Y	Y	TEX/CR	67	Y	P-BOX		
ISIS	2003		TOY43MH	TOY43ATE	TOY43FH*	Y	Y	TEX/CR	67	Y	P-BOX		
IST	2003		TOY43MH	TOY43ATE	TOY43FH*	Y	Y	TEX/CR	67	Y	P-BOX		
KLUGER	2001	2003	TOY43MH	TOY43ATE	TOY43FH*	Y	Y	TEXAS	4C	Y	P-BOX		
KLUGER	2003		TOY43MH	TOY43ATE	TOY43FH*	Y	Y	TEX/CR	67	Y	P-BOX		
LAND CRUISER PRADO	2000	2002	TOY43MH	TOY43ATE	TOY43FH*	Y	Y	TEXAS	4C	Y	P-BOX		
LAND CRUISER PRADO	2000	2002	TOY48MH		TOY48FH*	Y	Y	TEXAS	4C	Y	P-BOX		
LAND CRUISER PRADO	2002	2005	TOY43MH	TOY43ATE	TOY43FH*	Y	Y	TEX/CR	67	Y	P-BOX		

* Blade for "Flip" Key plastic head

See info on the uses of the keys on Silca Electronic Keys Catalogue



















1	2	2a	3	3a	3b	E1+E2		6	42+71	72	43 44a	12	15
						GTI Compatibility							
CAR MAKE/MODEL 	FROM 1995 	TO 2014 	SILCA REF.  Ref.	SILCA REF.  "TE" Silca Ref.	 SILCA REF.  "Flip Keys" Silca Ref.	COPY 	GEN. 	TRANSP. TYPE 	ID  FAST COPY PLUS RW4 PLUS FAST COPY/RW4	COPY  FAST COPY PLUS RW4 PLUS	COPY  FAST COPY RW4	STP   	
TOYOTA JAPAN													
MARK 2	2000	2006	TOY43MH	TOY43ATE	TOY43FH*	Y	Y	TEXAS	4C	Y	P-BOX		
MARK X	2004		TOY43MH	TOY43ATE	TOY43FH*	Y	Y	TEX/CR	67	Y	P-BOX		
NOAH	2004		TOY43MH	TOY43ATE	TOY43FH*	Y	Y	TEX/CR	67	Y	P-BOX		
OPEN DECK	2000	2005	TOY43MH	TOY43ATE	TOY43FH*	Y	Y	TEX/CR	67	Y	P-BOX		
ORIGIN	2000		TOY48MH		TOY48FH*	Y	Y	TEXAS	4C	Y	P-BOX		
PLATZ	1999	2002	TOY41RMH	TOY41RATE	TOY41RFH*	Y	Y	TEXAS	4C	Y	P-BOX		
PLATZ	2003	2005	TOY43MH	TOY43ATE	TOY43FH*	Y	Y	TEX/CR	67	Y	P-BOX		
PROGRÈS NC300	1998	2006	TOY48MH		TOY48FH*	Y	Y	TEXAS	4C	Y	P-BOX		
PRONARD	2000	2002	TOY43MH	TOY43ATE	TOY43FH*	Y	Y	TEXAS	4C	Y	P-BOX		
RAUM	2003		TOY43MH	TOY43ATE	TOY43FH*	Y	Y	TEX/CR	67	Y	P-BOX		
RAV 4	2003		TOY43MH	TOY43ATE	TOY43FH*	Y	Y	TEX/CR	67	Y	P-BOX		
REGIUSACE	2007		TOY43MH	TOY43ATE	TOY43FH*	Y	Y	TEX/CR	67	Y	P-BOX		
SIENTA	2003		TOY43MH	TOY43ATE	TOY43FH*	Y	Y	TEX/CR	67	Y	P-BOX		
TOYOACE	2008		TOY43MH	TOY43ATE	TOY43FH*	Y	Y	TEX/CR	67	Y	P-BOX		
VANGUARD	2005		TOY43MH	TOY43ATE	TOY43FH*	Y	Y	TEX/CR	67	Y	P-BOX		
VEROSSA	2001	2004	TOY43MH	TOY43ATE	TOY43FH*	Y	Y	TEXAS	4C	Y	P-BOX		
VITZ	2003		TOY43MH	TOY43ATE	TOY43FH*	Y	Y	TEX/CR	67	Y	P-BOX		
VOXY	2004		TOY43MH	TOY43ATE	TOY43FH*	Y	Y	TEX/CR	67	Y	P-BOX		
WINDOM	2001	2004	TOY48MH		TOY48FH*	Y	Y	TEXAS	4C	Y	P-BOX		
WISH	2003		TOY43MH	TOY43ATE	TOY43FH*	Y	Y	TEX/CR	67	Y	P-BOX		
TOYOTA USA													
4RUNNER	1999	2002	TOY43MH	TOY43ATE	TOY43FH*	Y	Y	TEXAS	4C	Y	P-BOX		
4RUNNER	2003	2010	TOY43MH	TOY43ATE	TOY43FH*	Y	Y	TEX/CR	67	Y	P-BOX		
AVALON	1998	2004	TOY43MH	TOY43ATE	TOY43FH*	Y	Y	TEXAS	4C	Y	P-BOX		
AVALON	2005	2011	TOY43MH	TOY43ATE	TOY43FH*	Y	Y	TEX/CR	67	Y	P-BOX		
AVANZA	2004		TOY43MH	TOY43ATE	TOY43FH*	Y	Y	TEX/CR	67	Y	P-BOX		
CAMRY	1998	2004	TOY43MH	TOY43ATE	TOY43FH*	Y	Y	TEXAS	4C	Y	P-BOX		
CAMRY	2003	2010	TOY43MH	TOY43ATE	TOY43FH*	Y	Y	TEX/CR	67	Y	P-BOX		
COROLLA	2005	2010	TOY43MH	TOY43ATE	TOY43FH*	Y	Y	TEX/CR	67	Y	P-BOX		
FJ CRUISER	2007	2010	TOY43MH	TOY43ATE	TOY43FH*	Y	Y	TEX/CR	67	Y	P-BOX		
HIACE	2006		TOY43MH	TOY43ATE	TOY43FH*	Y	Y	TEX/CR	67	Y	P-BOX		
HIGHLANDER	2001	2003	TOY43MH	TOY43ATE	TOY43FH*	Y	Y	TEXAS	4C	Y	P-BOX		
HIGHLANDER	2004	2010	TOY43MH	TOY43ATE	TOY43FH*	Y	Y	TEX/CR	67	Y	P-BOX		
LAND CRUISER	1998	2002	TOY43MH	TOY43ATE	TOY43FH*	Y	Y	TEXAS	4C	Y	P-BOX		
LAND CRUISER	2003	2008	TOY43MH	TOY43ATE	TOY43FH*	Y	Y	TEX/CR	67	Y	P-BOX		
MATRIX	2005	2010	TOY43MH	TOY43ATE	TOY43FH*	Y	Y	TEX/CR	67	Y	P-BOX		

* Blade for "Flip" Key plastic head

See info on the uses of the keys on Silca Electronic Keys Catalogue 

Car Keys Guide / Guida Chiavi Auto / Führer für Autoschlüssel / Guide Clés pour Voitures
 Guía Llaves para Coches / Guia Chaves para Carros

















New Updates

1	2	2a	3	3a	3b	E1+E2		6	42+71	72	43 44a	12	15
						GTI Compatibility							
CAR MAKE/MODEL 	FROM 1995 	TO 2014 	SILCA REF.  Ref.	SILCA REF.  "TE" Silca Ref.	 SILCA REF.  "Flip Keys" Silca Ref.	COPY 	GEN. 	TRANSP. TYPE 	ID  FAST COPY PLUS RW4 PLUS FAST COPY/RW4	COPY  FAST COPY PLUS RW4 PLUS	COPY  FAST COPY RW4	STP   	
TOYOTA USA													
MR2	2001	2005	TOY41RMH	TOY41RTE	TOY41RFH*	Y	Y	TEXAS	4C	Y	P-BOX		
PRIUS	2001	2003	TOY43MH	TOY43ATE	TOY43FH*	Y	Y	TEXAS	4C	Y	P-BOX		
PRIUS	2004	2008	TOY43MH	TOY43ATE	TOY43FH*	Y	Y	TEX/CR	67	Y	P-BOX		
RAV 4	2006	2010	TOY43MH	TOY43ATE	TOY43FH*	Y	Y	TEX/CR	67	Y	P-BOX		
SEQUOIA	2001	2002	TOY43MH	TOY43ATE	TOY43FH*	Y	Y	TEXAS	4C	Y	P-BOX		
SEQUOIA	2003	2010	TOY43MH	TOY43ATE	TOY43FH*	Y	Y	TEX/CR	67	Y	P-BOX		
SIENNA	1999	2003	TOY43MH	TOY43ATE	TOY43FH*	Y	Y	TEXAS	4C	Y	P-BOX		
SIENNA	2004	2010	TOY43MH	TOY43ATE	TOY43FH*	Y	Y	TEX/CR	67	Y	P-BOX		
SOLARA	2002	2003	TOY43MH	TOY43ATE	TOY43FH*	Y	Y	TEXAS	4C	Y	P-BOX		
SOLARA	2004	2010	TOY43MH	TOY43ATE	TOY43FH*	Y	Y	TEX/CR	67	Y	P-BOX		
TACOMA	2005	2010	TOY43MH	TOY43ATE	TOY43FH*	Y	Y	TEX/CR	67	Y	P-BOX		
TUNDRA	2005	2010	TOY43MH	TOY43ATE	TOY43FH*	Y	Y	TEX/CR	67	Y	P-BOX		
VENZA	2009	2010	TOY43MH	TOY43ATE	TOY43FH*	Y	Y	TEX/CR	67	Y	P-BOX		
YARIS	2007	2011	TOY43MH	TOY43ATE	TOY43FH*	Y	Y	TEX/CR	67	Y	P-BOX		
VOLKSWAGEN													
BEETLE	1998	2004	HU66T6		HU66FH*			MEG/CR	48				
BEETLE	2005	2008	HU66T24		HU66FH*			MEG/CR	A1				
BORA	1998	2005	HU66T6		HU66FH*			MEG/CR	48				
CABRIO	2000	2005	HU66T28		HU66FH*			PH/CR	4W	RD	RD		
CADDY	2004	2007	HU66T24		HU66FH*			MEG/CR	A1				
CROSS GOLF	2006	2007	HU66T24		HU66FH*			MEG/CR	A1				
EOS	2006	2007	HU66T24		HU66FH*			MEG/CR	A1				
EURO VAN	2000	2004	HU66T6		HU66FH*			MEG/CR	48				
FOX	2005	2008	HU66T6		HU66FH*			MEG/CR	48				
GOLF	1998	2004	HU66T6		HU66FH*			MEG/CR	48				
GOLF	2004	2008	HU66T24		HU66FH*			MEG/CR	A1				
GOLF CABRIO	1998	2000	HU66T10		HU66FH*			PH/CR	42	Y	Y		
GOLF CABRIO	2000	2004	HU66T28		HU66FH*			PH/CR	4W	RD	RD		
GOLF CABRIO	2004		HU66T24		HU66FH*			MEG/CR	A1				
GOLF GTI	2000	2004	HU66T6		HU66FH*			MEG/CR	48				
INDIVIDUAL	2004		HU66T24		HU66FH*			MEG/CR	A1				
JETTA	2000	2004	HU66T6		HU66FH*			MEG/CR	48				
JETTA	2004	2007	HU66T24		HU66FH*			MEG/CR	A1				
LUPO	1998	2000	HU66T10		HU66FH*			PH/CR	42	Y	Y		
LUPO	2000	2005	HU66T28		HU66FH*			PH/CR	4W	RD	RD		
MULTIVAN	2003	2008	HU66T24		HU66FH*			MEG/CR	A1				

* Blade for "Flip" Key plastic head

See info on the uses of the keys on Silca Electronic Keys Catalogue



1	2	2a	3	3a	3b	E1+E2		6	42+71	72	43 44a	12	15
						GTI Compatibility							
CAR MAKE/MODEL 	FROM 1995 	TO 2014 	SILCA REF.  Ref.	SILCA REF.  "TE" Silca Ref.	 SILCA REF.  "Flip Keys" Silca Ref.	COPY 	GEN. 	TRANSP. TYPE 	ID  FAST COPY PLUS RW4 PLUS FAST COPY/RW4	COPY  FAST COPY PLUS RW4 PLUS	COPY  FAST COPY RW4	STP  	
VOLKSWAGEN													
PASSAT	1997	1998	HU66CT5		HU66FH*			MEG	13	Y	Y		
PASSAT	1997	1998	HU66T5		HU66FH*			MEG	13	Y	Y		
PASSAT	1998	2004	HU66CT6		HU66FH*			MEG/CR	48				
PASSAT	1998	2004	HU66T6		HU66FH*			MEG/CR	48				
PASSAT	2004	2005	HU66T24		HU66FH*			MEG/CR	A1				
PASSAT W8	2002	2004	HU66T6		HU66FH*			MEG/CR	48				
POLO	1998	2000	HU66T10		HU66FH*			PH/CR	42	Y	Y		
POLO	2000	2001	HU66T28		HU66FH*			PH/CR	4W	RD	RD		
POLO	2001	2005	HU66T6		HU66FH*			MEG/CR	48				
POLO	2005	2009	HU66T24		HU66FH*			MEG/CR	A1				
SHARAN	1995	1998	HU66T5		HU66FH*			PH	33	Y	Y	S-V	
SHARAN	1998	2000	HU66T10		HU66FH*			PH/CR	42	Y	Y		
SHARAN	2000	2004	HU66T28		HU66FH*			PH/CR	4W	RD	RD		
SHARAN	2005	2009	HU66T6		HU66FH*			MEG/CR	48				
TOURAN	2003		HU66T24		HU66FH*			MEG/CR	A1				
TRANSPORTER	2001	2004	HU66T28		HU66FH*			PH/CR	4W	RD	RD		
TRANSPORTER	2004	2008	HU66T24		HU66FH*			MEG/CR	A1				
VOLKSWAGEN S.AMERICA													
FOX	2009		HU66T24		HU66FH*			MEG/CR	A1				
GOL	2005	2008	HU66T6		HU66FH*			MEG/CR	48				
GOL	2009		HU66T24		HU66FH*			MEG/CR	A1				
GOLF	1998		HU66T6		HU66FH*			MEG/CR	48				
SPACEFOX	2005	2008	HU66T6		HU66FH*			MEG/CR	48				
VOYAGE	2009		HU66T24		HU66FH*			MEG/CR	A1				
VOLVO													
S40	1996	1998	HU56RAT2		HU56RFH*			PH	73	Y	Y		
V40	1996	1998	HU56RAT2		HU56RFH*			PH	73	Y	Y		

Motorcycle Keys Guide / Guida Chiavi Moto / Führer für Motorräderschlüssel
 Guide Clés pour Motocyclettes / Guía Llaves para Motocicletas / Guia Chaves para Motocicletas

New Updates

1	2	2a	3	3a	3b	E1+E2		6	42+71	72	43 44a	12	15
MOTORCYCLE MAKE/MODEL 	FROM 1995	TO 2014	SILCA REF. Ref.	SILCA REF. "TE" Silca Ref.	SILCA REF. "Flip Keys" Silca Ref.	COPY 	GEN. 	TRANSP. TYPE 	IGNITION 				
									ID FAST COPY PLUS RW4 PLUS FAST COPY/RW4	COPY FAST COPY PLUS RW4 PLUS	COPY FAST COPY RW4	STP 	
BMW®													
C600 SPORT	2012		BW9MH			Y		PH/CR2	46	Y		P-BOX	
C650 GT	2012		BW9MH			Y		PH/CR2	46	Y		P-BOX	
F650	2008	2011	BW9EHP					PH/CR2	46	Y		P-BOX	
F650	2008	2011	BW9MH			Y		PH/CR2	46	Y		P-BOX	
G650	2011		BW9MH			Y		PH/CR2	46	Y		P-BOX	
K1200	2005	2008	BW9EHP					PH/CR2	46	Y		P-BOX	
K1200	2005	2008	BW9MH			Y		PH/CR2	46	Y		P-BOX	
K1300	2009		BW9MH			Y		PH/CR2	46	Y		P-BOX	
K1600	2011		BW9MH			Y		PH/CR2	46	Y		P-BOX	
GILERA®													
FUOCO	2006		SIP22T5		SIP22FH*			TEMIC	11	Y	Y	T-F	S9
GP800	2006		SIP22T5		SIP22FH*			TEMIC	11	Y	Y	T-F	S9
NEXUS 250	2006	2008	ZD24RT5		ZD24RFH*			TEMIC	11	Y	Y	T-F	S9
NEXUS 300	2007		ZD24RT5		ZD24RFH*			TEMIC	11	Y	Y		S9
NEXUS 500	2006	2012	SIP22T5		SIP22FH*			TEMIC	11	Y	Y	T-F	S9
TYPHOON	1995	2001	ZD17RAP										
HONDA®													
BLACK SPIRIT	2010		HON70MH	HON70TE	HON70FH*	Y	Y	PH/CR2	46	Y		P-BOX	
BLACK SPIRIT	2010		HON70T14					PH/CR2	46				
CBF500	2004	2007	HON63FP										
CBF600	2004	2007	HON63FP										
CBF600	2007	2012	HON70MH	HON70TE	HON70FH*	Y	Y	PH/CR2	46	Y		P-BOX	
CBF600	2007	2012	HON70T14					PH/CR2	46				
CBR1000	2004		HON70MH	HON70TE	HON70FH*	Y	Y	PH/CR2	46	Y		P-BOX	
CBR1100XX	1999	2006	HON70EHP					PH/CR2	46	Y		P-BOX	
CBR1100XX	1999	2006	HON70MH	HON70TE	HON70FH*	Y	Y	PH/CR2	46	Y		P-BOX	
CBR1100XX	1999	2006	HON70T14					PH/CR2	46				
CBR600F	1999	2006	HON70MH	HON70TE	HON70FH*	Y	Y	PH/CR2	46	Y		P-BOX	
CBR600RR	2003		HON70MH	HON70TE	HON70FH*	Y	Y	PH/CR2	46	Y		P-BOX	
CBR900	2003		HON70MH	HON70TE	HON70FH*	Y	Y	PH/CR2	46	Y		P-BOX	
CROSSRUNNER	2011		HON70MH	HON70TE	HON70FH*	Y	Y	PH/CR2	46	Y		P-BOX	
CROSSTOURER	2012		HON70MH	HON70TE	HON70FH*	Y	Y	PH/CR2	46	Y		P-BOX	
CTX1300	2014		HON70MH	HON70TE	HON70FH*	Y	Y	PH/CR2	46	Y		P-BOX	
CTX1300	2014		HON70T14					PH/CR2	46				
CTX700	2014		HON70MH	HON70TE	HON70FH*	Y	Y	PH/CR2	46	Y		P-BOX	
CTX700	2014		HON70T14					PH/CR2	46				













* Blade for "Flip" Key plastic head

See info on the uses of the keys on Silca Electronic Keys Catalogue















Motorcycle Keys Guide / Guida Chiavi Moto / Führer für Motorräderschlüssel Guide Clés pour Motocyclettes / Guía Llaves para Motocicletas / Guia Chaves para Motocicletas

New Updates

1	2	2a	3	3a	3b	E1+E2	6	42+71	72	43 44a	12	15	
						GTI Compatibility							
MOTORCYCLE MAKE/MODEL 	FROM 1995	TO 2014	SILCA REF.  Ref.	SILCA REF.  "TE" Silca Ref.	SILCA REF.  "Flip Keys" Silca Ref.	COPY 	GEN. 	TRANSP. TYPE 	ID  FAST COPY PLUS RW4 PLUS FAST COPY/RW4	COPY  FAST COPY PLUS RW4 PLUS	COPY  FAST COPY RW4	STP 	
HONDA®													
GOLD WING	2001		HON58RMH		HON58RFH*	Y	Y	PH/CR2	46	Y	P-BOX		
HORNET	2003		HON70MH	HON70TE	HON70FH*	Y	Y	PH/CR2	46	Y	P-BOX		
INTEGRA	2012		HON70MH	HON70TE	HON70FH*	Y	Y	PH/CR2	46	Y	P-BOX		
LEAD 100	2003	2007	HON41										
LEAD 100	2003	2007	HON41P										
NC700 S	2012		HON70MH	HON70TE	HON70FH*	Y	Y	PH/CR2	46	Y	P-BOX		
NC700 X	2012		HON70MH	HON70TE	HON70FH*	Y	Y	PH/CR2	46	Y	P-BOX		
NC750	2014		HON70MH	HON70TE	HON70FH*	Y	Y	PH/CR2	46	Y	P-BOX		
NC750	2014		HON70T14					PH/CR2	46				
NT650V	1999	2006	HON70MH	HON70TE	HON70FH*	Y	Y	PH/CR2	46	Y	P-BOX		
NT700V	2006	2012	HON70EHP					PH/CR2	46	Y	P-BOX		
NT700V	2006	2012	HON70MH	HON70TE	HON70FH*	Y	Y	PH/CR2	46	Y	P-BOX		
NT700V	2006	2012	HON70T14					PH/CR2	46				
SH300	2007		ZD24RMH	ZD24RTE	ZD24RFH*	Y	Y	PH/CR2	46	Y	P-BOX		
SHADOW 750	2004		HON70MH	HON70TE	HON70FH*	Y	Y	PH/CR2	46	Y	P-BOX		
SILVER WING	2001	2008	HON70MH	HON70TE	HON70FH*	Y	Y	PH/CR2	46	Y	P-BOX		
ST1300 PAN-EUROPEAN	2008		HON70MH	HON70TE	HON70FH*	Y	Y	PH/CR2	46	Y	P-BOX		
SW-T400	2009		HON70MH	HON70TE	HON70FH*	Y	Y	PH/CR2	46	Y	P-BOX		
SW-T600	2011		HON70MH	HON70TE	HON70FH*	Y	Y	PH/CR2	46	Y	P-BOX		
VARADERO	2003		HON70MH	HON70TE	HON70FH*	Y	Y	PH/CR2	46	Y	P-BOX		
VFR1200	2009		HON70MH	HON70TE	HON70FH*	Y	Y	PH/CR2	46	Y	P-BOX		
VFR1200	2009		HON70T14					PH/CR2	46				
VFR800	2006		HON70MH	HON70TE	HON70FH*	Y	Y	PH/CR2	46	Y	P-BOX		
VFR800	2006		HON70T14					PH/CR2	46				
VT1300CX	2009		HON70MH	HON70TE	HON70FH*	Y	Y	PH/CR2	46	Y	P-BOX		
VT1300CX	2009		HON70T14					PH/CR2	46				
VT750 C4	2004	2010	HON70EHP					PH/CR2	46	Y	P-BOX		
VT750 C4	2004	2010	HON70MH	HON70TE	HON70FH*	Y	Y	PH/CR2	46	Y	P-BOX		
VTX1800C	2002		HON70MH	HON70TE	HON70FH*	Y	Y	PH/CR2	46	Y	P-BOX		
X-ELEVEN	2001	2003	HON70EHP					PH/CR2	46	Y	P-BOX		
X-ELEVEN	2001	2003	HON70MH	HON70TE	HON70FH*	Y	Y	PH/CR2	46	Y	P-BOX		
X-ELEVEN	2001	2003	HON70T14					PH/CR2	46				
KAWASAKI®													
EJ650	1999	2006	KW16CP		KW16FH*								
EJ800	2011		KW16CP		KW16FH*								
ER-5	2001	2005	KW16CP		KW16FH*								

Motorcycle Keys Guide / Guida Chiavi Moto / Führer für Motorräderschlüssel
 Guide Clés pour Motocyclettes / Guía Llaves para Motocicletas / Guia Chaves para Motocicletas

New Updates

1	2	2a	3	3a	3b	E1+E2	6	42+71	72	43 44a	12	15	
MOTORCYCLE MAKE/MODEL		FROM 1995	TO 2014	SILCA REF.	SILCA REF.	SILCA REF.	COPY	GEN.	TRANSP. TYPE	ID	COPY	COPY	STP
													
				Ref.	"TE" Silca Ref.	"Flip Keys" Silca Ref.				FAST COPY PLUS RW4 PLUS FAST COPY/RW4	FAST COPY PLUS RW4 PLUS	FAST COPY RW4	
KAWASAKI®													
NINJA ZX-6R	2003	2006	KW16CP			KW16FH*							
NINJA ZX-6R	2006		KW16MH			KW16FH*	Y	Y	TEX/CR	72	Y	P-BOX	
NINJA ZX-7R	2003		KW16CP			KW16FH*							
NINJA ZX-9R	2003		KW16CP			KW16FH*							
NINJA ZX-10R	2004	2010	KW16MH			KW16FH*	Y	Y	TEX/CR	72	Y	P-BOX	
NINJA ZX-12R	2000	2006	KW16CP			KW16FH*							
NINJA ZX-12R	2002	2006	KW16MH			KW16FH*	Y	Y	TEX/CR	72	Y	P-BOX	
NINJA ZX-14R	2006	2011	KW16MH			KW16FH*	Y	Y	TEX/CR	72	Y	P-BOX	
Z1000	2003	2005	KW16CP			KW16FH*							
Z1000	2004	2009	KW16MH			KW16FH*	Y	Y	TEX/CR	72	Y	P-BOX	
Z750	1998	2005	KW16CP			KW16FH*							
Z750S	2006		KW16MH			KW16FH*	Y	Y	TEX/CR	72	Y	P-BOX	
ZR-7	1999	2005	KW16CP			KW16FH*							
ZRX1100	1999	2000	KW16CP			KW16FH*							
ZRX1200	2001	2006	KW16CP			KW16FH*							
ZZR1200	2000	2005	KW16CP			KW16FH*							
ZZR1200	2002	2006	KW16MH			KW16FH*	Y	Y	TEX/CR	72	Y	P-BOX	
ZZR1400	2007	2011	KW16MH			KW16FH*	Y	Y	TEX/CR	72	Y	P-BOX	
SOME MODELS			KW16CP			KW16FH*							
MBK®													
BOOSTER	1997	2004	ZD23RT5						TEMIC	12	Y	Y	
BOOSTER	1999	2004	ZD24RT5			ZD24RFH*			TEMIC	12	Y	Y	
EVOLIS	1995	1998	ZD16RP										
KILIBRE	2003	2004	ZD24RDP										
OVETTO	1998	2004	ZD23RT5						TEMIC	12	Y	Y	
OVETTO	1998	2004	ZD24RDP										
MOTO GUZZI®													
350 NEVADA	1994	2002	ZD9										
350 NEVADA	1994	2002	ZD9P										
750 NEVADA	1994	2002	ZD9										
750 NEVADA	1994	2002	ZD9P										
BREVA	2003	2011	ZD24RDP										
CALIFORNIA EV	2003	2006	ZD24RDP										
STELVIO	2007		ZD30T5						TEMIC	12	Y	Y	
V11	2003	2006	ZD24RDP										













* Blade for "Flip" Key plastic head

See info on the uses of the keys on Silca Electronic Keys Catalogue



Motorcycle Keys Guide / Guida Chiavi Moto / Führer für Motorräderschlüssel
 Guide Clés pour Motocyclettes / Guía Llaves para Motocicletas / Guia Chaves para Motocicletas

New Updates

1	2	2a	3	3a	3b	E1+E2	6	42+71	72	43 44a	12	15	
MOTORCYCLE MAKE/MODEL 	FROM	TO	SILCA REF.	SILCA REF.	SILCA REF.	COPY	GEN.	TRANSP. TYPE	ID	COPY	COPY	STP	
	1995	2014	 Ref.	 "TE" Silca Ref.	 "Flip Keys" Silca Ref.				 FAST COPY PLUS RW4 PLUS FAST COPY/RW4	 FAST COPY PLUS RW4 PLUS	 FAST COPY RW4		
PIAGGIO®													
BEVERLY	2002	2011	GT15RDT5		GT15RFH*			TEMIC	11	Y	Y	T-F	S9
BEVERLY	2010		SIP22T5		SIP22FH*			TEMIC	11	Y	Y	T-F	S9
CARNABY	2007		GT15RDP		GT15RFH*								
CARNABY	2009		GT15RDT5		GT15RFH*			TEMIC	11	Y	Y	T-F	S9
FLY	2005	2012	GT15RDP		GT15RFH*								
FLY	2009	2012	GT15RDT5		GT15RFH*			TEMIC	11	Y	Y	T-F	S9
FREE	1995	2003	ZD17RAP										
HEXAGON	1998	2003	GT15RDT5		GT15RFH*			TEMIC	11	Y	Y	T-F	S9
LIBERTY	2000		GT15RP		GT15RFH*								
LIBERTY	2003		GT15RDT5		GT15RFH*			TEMIC	11	Y	Y	T-F	S9
MP3	2006		SIP22T5		SIP22FH*			TEMIC	11	Y	Y	T-F	S9
SKIPPER	1999	2000	GT15RDP		GT15RFH*								
SKIPPER	2000	2002	GT15RDT5		GT15RFH*			TEMIC	11	Y	Y	T-F	S9
VESPA	1996		GT15RDP		GT15RFH*								
VESPA	1996		GT15RDT5		GT15RFH*			TEMIC	11	Y	Y	T-F	S9
X10	2012		SIP22T5		SIP22FH*			TEMIC	11	Y	Y	T-F	S9
X7	2007	2009	GT15RDT5		GT15RFH*			TEMIC	11	Y	Y	T-F	S9
X7	2010		SIP22T5		SIP22FH*			TEMIC	11	Y	Y	T-F	S9
X8	2004		GT15RDT5		GT15RFH*			TEMIC	11	Y	Y	T-F	S9
X8	2006		SIP22T5		SIP22FH*			TEMIC	11	Y	Y	T-F	S9
X9	1998	2007	GT15RDT5		GT15RFH*			TEMIC	11	Y	Y	T-F	S9
XEVO	2006		SIP22T5		SIP22FH*			TEMIC	11	Y	Y	T-F	S9
ZIP	2000	2011	GT15RDP		GT15RFH*								
SOME MODELS	1996		GT15RDT5		GT15RFH*			TEMIC	11	Y	Y	T-F	S9
SOME MODELS	1996		GT15RMH		GT15RFH*								
SUZUKI®													
DR650	1995	1998	SZ14RAP										
GSF BANDIT	2007		SZ17RMH		SZ17RFH*	Y	Y	TEX/CR	71	Y		P-BOX	
GSR600	2007		SZ17RMH		SZ17RFH*	Y	Y	TEX/CR	71	Y		P-BOX	
GSX1300 HAYABUSA	2007		SZ17RMH		SZ17RFH*	Y	Y	TEX/CR	71	Y		P-BOX	
GSX-R1000	2006		SZ17RMH		SZ17RFH*	Y	Y	TEX/CR	71	Y		P-BOX	
GSX-R600	2006		SZ17RMH		SZ17RFH*	Y	Y	TEX/CR	71	Y		P-BOX	
GSX-R750	2006		SZ17RMH		SZ17RFH*	Y	Y	TEX/CR	71	Y		P-BOX	
V-STROM	2007		SZ17RMH		SZ17RFH*	Y	Y	TEX/CR	71	Y		P-BOX	













* Blade for "Flip" Key plastic head

See info on the uses of the keys on Silca Electronic Keys Catalogue



Motorcycle Keys Guide / Guida Chiavi Moto / Führer für Motorräderschlüssel
 Guide Clés pour Motocyclettes / Guía Llaves para Motocicletas / Guia Chaves para Motocicletas

New Updates

1	2	2a	3	3a	3b	E1+E2		6	42+71	72	43 44a	12	15
						GTI Compatibility							
MOTORCYCLE MAKE/MODEL	FROM	TO	SILCA REF.	SILCA REF.	SILCA REF.	COPY	GEN.	TRANSP. TYPE	ID	COPY	COPY	STP	
	1995	2014	 Ref.	 "TE" Silca Ref.	 "Flip Keys" Silca Ref.				 FAST COPY PLUS RW4 PLUS FAST COPY/RW4	 FAST COPY PLUS RW4 PLUS	 FAST COPY RW4		
TRIUMPH®													
TIGER	2010		ZD24RMH	ZD24RTE	ZD24RFH*	Y		PH/CR2	46	Y	P-BOX		
YAMAHA®													
AEROX	1998		ZD24RT5		ZD24RFH*			MEG	13	Y	Y		
BT1100 BULLDOG	2005		YH35RMH	YH35RATE	YH35RFH*	Y	Y	TEX/CR	69	Y	P-BOX		
FJR1300	2005		YH35RMH	YH35RATE	YH35RFH*	Y	Y	TEX/CR	69	Y	P-BOX		
FZ1	2006		YH35RMH	YH35RATE	YH35RFH*	Y	Y	TEX/CR	69	Y	P-BOX		
FZ6	2004	2011	YH35RAT22					TEX/CR	69				S12
FZ6	2004	2011	YH35REH2					TEX/CR	69	Y	Y		
FZ6	2004	2011	YH35RMH	YH35RATE	YH35RFH*	Y	Y	TEX/CR	69	Y	P-BOX		
FZ8	2010		YH35RMH	YH35RATE	YH35RFH*	Y	Y	TEX/CR	69	Y	P-BOX		
FZS1000 FAZER	2005		YH35RMH	YH35RATE	YH35RFH*	Y	Y	TEX/CR	69	Y	P-BOX		
MAJESTY 400	2005		YH35RMH	YH35RATE	YH35RFH*	Y	Y	TEX/CR	69	Y	P-BOX		
MT-01	2005	2012	YH35RAT22					TEX/CR	69				S12
MT-01	2005	2012	YH35REH2					TEX/CR	69	Y	Y		
MT-01	2005	2012	YH35RMH	YH35RATE	YH35RFH*	Y	Y	TEX/CR	69	Y	P-BOX		
MT-03	2006		YH35RMH	YH35RATE	YH35RFH*	Y	Y	TEX/CR	69	Y	P-BOX		
NEOS	1998		ZD24RT5		ZD24RFH*			MEG	13	Y	Y		
TDM600	2005		YH35RMH	YH35RATE	YH35RFH*	Y	Y	TEX/CR	69	Y	P-BOX		
T-MAX 500	2005	2012	YH35RAT22					TEX/CR	69				S12
T-MAX 500	2005	2012	YH35REH2					TEX/CR	69	Y	Y		
T-MAX 500	2005	2012	YH35RMH	YH35RATE	YH35RFH*	Y	Y	TEX/CR	69	Y	P-BOX		
VERSITY 300	2003	2006	ZD24RDP										
XJR 1300	2004		YH35RMH	YH35RATE	YH35RFH*	Y	Y	TEX/CR	69	Y	P-BOX		
X-MAX 125	2006		ZD24RMH	ZD24RTE	ZD24RFH*	Y	Y	TEX/CR	69	Y	P-BOX		
XT1200Z SUPER TÉNÉRÉ	2010		YH35RMH	YH35RATE	YH35RFH*	Y	Y	TEX/CR	69	Y	P-BOX		
XT660Z TÉNÉRÉ	2008		YH35RMH	YH35RATE	YH35RFH*	Y	Y	TEX/CR	69	Y	P-BOX		
XTR	2004		YH35RMH	YH35RATE	YH35RFH*	Y	Y	TEX/CR	69	Y	P-BOX		
XTX	2004		YH35RMH	YH35RATE	YH35RFH*	Y	Y	TEX/CR	69	Y	P-BOX		
XVS1100A DRAGSTAR	2004		YH35RMH	YH35RATE	YH35RFH*	Y	Y	TEX/CR	69	Y	P-BOX		
XVS650A DRAGSTAR	2004	2006	YH35RAT22					TEX/CR	69				S12
XVS650A DRAGSTAR	2004	2006	YH35REH2					TEX/CR	69	Y	Y		
XVS650A DRAGSTAR	2004	2006	YH35RMH	YH35RATE	YH35RFH*	Y	Y	TEX/CR	69	Y	P-BOX		
XVZ1300	1996	2002	YH35R										
XVZ1300	1996	2002	YH35RBP										
YZF-R1	2005		YH35RMH	YH35RATE	YH35RFH*	Y	Y	TEX/CR	69	Y	P-BOX		
YZF-R6	2003		YH35RMH	YH35RATE	YH35RFH*	Y	Y	TEX/CR	69	Y	P-BOX		













* Blade for "Flip" Key plastic head

See info on the uses of the keys on Silca Electronic Keys Catalogue



Truck Keys Guide / Guida Chiavi Camion / Führer für LKW Schlüssel
 Guide Clés pour Camions / Guía Llaves para Camiones / Guia Chaves para Camiões

New Updates

1	2	2a	3	3a	3b	E1+E2		6	42+71	72	43 44a	12	15	
TRUCK MAKE/MODEL		FROM	TO	SILCA REF.	SILCA REF.	SILCA REF.	COPY	GEN.	TRANSP. TYPE	ID	COPY	COPY	STP	
		1995	2014	 Ref.	 "TE" Silca Ref.	 "Flip Keys" Silca Ref.								
DAF®														
CF	2002		NE73T6		NE73FH*				MEG/CR	48				
LF	2002		NE73T6		NE73FH*				MEG/CR	48				
XF	2002		NE73T6		NE73FH*				MEG/CR	48				
FORD USA®														
HEAVY TRUCKS	2000	2004	FO38RMH	FO38RTE	FO38FH	Y	Y	TEXAS	4C	Y	P-BOX			
MAN®														
TGA	2003		HU83T5		HU83FH*			MEG	13	Y	Y			
NISSAN®														
ATLEON	2002		NSN11MH	NSN11TE	NSN11FH*	Y	Y	TEX/CR	60	Y	P-BOX			
CAB STAR	2000	2003	NSN11MH	NSN11TE	NSN11FH*	Y	Y	TEX/CR	60	Y	P-BOX			
CAB STAR	2003	2007	NSN11MH	NSN11TE	NSN11FH*	Y	Y	TEX/CR	XX	Y	P-BOX			
CAB STAR	2007		NSN19MH	NSN19TE	NSN19FH*	Y		PH/CR2	46	Y	P-BOX			
SCANIA®														
164	2004		HU71MH		HU71FH*	Y		TEX/CR	60	Y	P-BOX			
R144-NA	1996		HU71P		HU71FH*									
R-SERIES	2005		HU71MH		HU71FH*	Y		TEX/CR	60	Y	P-BOX			
SOME MODELS	1996		HU71P		HU71FH*									
STERLING®														
BULLET	2008		CY24MH		CY24FH*	Y	Y	PH/CR2	46	Y	P-BOX			

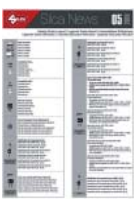

IMPORTANT NOTE:

See also "Vehicle Guide Legend"

Vedi anche "Legenda Guida Veicoli"

Siehe auch "Autoschlüssel Erläuterung"

Voir aussi "Légende Guide Véhicules"

Véase también "Leyenda Guía para Vehículos"

Veja também "Legenda Guia para Veículos"





WAITING TIME IS OVER FUTURA IS HERE

GROUND-BREAKING FUNCTIONALITIES PLUS PORTABILITY



Automatic

Intuitive use, software guided procedures, led lighting indicators

Multifunction

A unique key cutting machine to duplicate multiple key types

Innovative

Touch screen tablet integrated, remote service assistance

Portable

Inspiring design, compact dimension, easy to transport

www.silca.biz

PER:
FOR:

AUDI (D)
FORD (D)
PORSCHE (D)
SEAT (E)
SKODA (CZ)
VOLKSWAGEN (D)

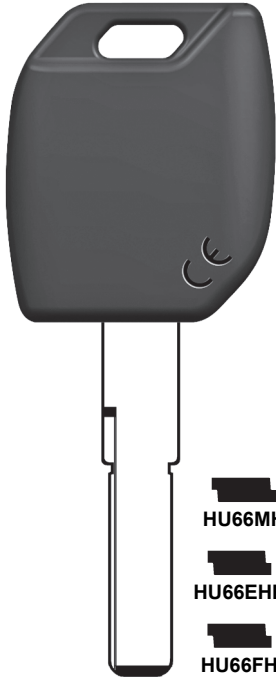

HU66MH

HU66EHP

HU66FH

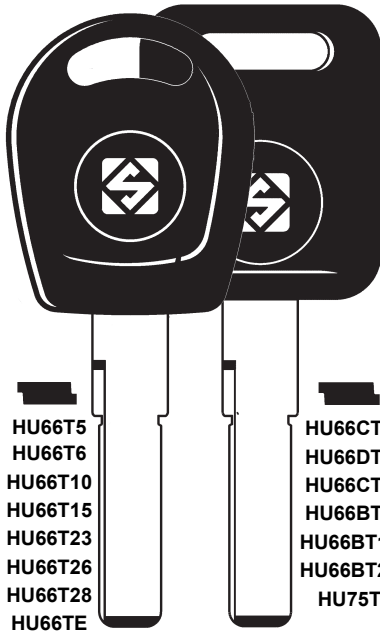

HU66T5
HU66T6
HU66T10
HU66T15
HU66T23
HU66T26
HU66T28
HU66TE

HU66CT5
HU66DT5
HU66CT6
HU66BT1
HU66BT15
HU66BT28
HU75T

HU66P

HU66AT5
HU66AT6

HUF (D) - WITTE (D)



FUTURA

OPTIONAL



D743255ZB

03J Jaw
Ganascia 03J
03J Backe
Mâchoire 03J
Quijada 03J
Garra 03J

STANDARD



D943254ZR

02J Jaw
Ganascia 02J
02J Backe
Mâchoire 02J
Quijada 02J
Garra 02J

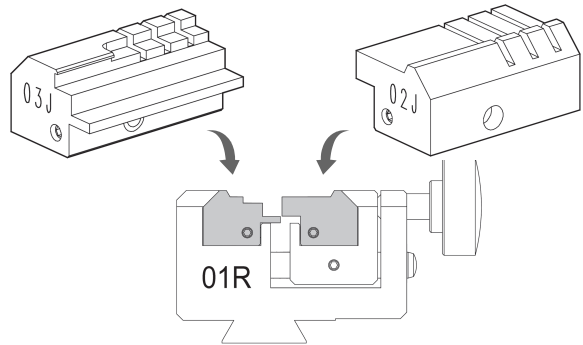

STANDARD



D742606ZB

Cutter 01L
Fresa 01L
Fräser 01L
Fraise 01L
Fresa 01L
Fresa 01L

Delivery time MARCH 2014
Disponibilità MARZO 2014
Lieferbar MÄRZ 2014
Disponibilité MARS 2014
Disponibilidad MARZO 2014
Disponibilidade MARÇO 2014

FOR:
PER:

ASSA (S)

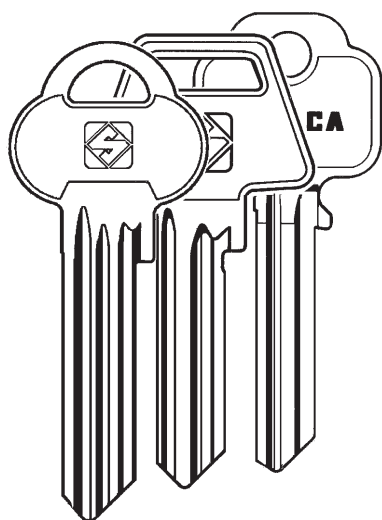

(DP, CLIQ)
(D-12)



FUTURA

OPTIONAL

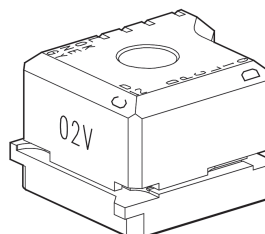

D743271ZB

02V clamp for ASSA type keys (long keys, D-12*, DP, CLIQ)
Morsetto 02V per chiavi tipo ASSA (chiavi lunghe, D-12*, DP, CLIQ)
Spannbacke 02V für ASSA Schlüsseltyp (lange Schlüssel, D-12*, DP, CLIQ)
Etau 02V pour clés type ASSA (clés longues, D-12*, DP, CLIQ)
Mordaza 02V para llaves de tipo ASSA (llaves largas, D-12*, DP, CLIQ)
Mordente 02V para chaves do tipo ASSA (chaves longas, D-12*, DP, CLIQ)

*D-12: Key duplicable by code only
*D-12: Chiave duplicabile solo a codice
*D-12: Kopierenschlüssel nur zur Code
*D-12: Clé à copier uniquement par code
*D-12: Llave duplicable sólo a código
*D-12: Chave duplicable somente por código

Delivery time MARCH 2014
Disponibilità MARZO 2014
Lieferbar MÄRZ 2014
Disponibilité MARS 2014
Disponibilidad MARZO 2014
Disponibilidade MARÇO 2014

FOR:
PER:

BMW (D)

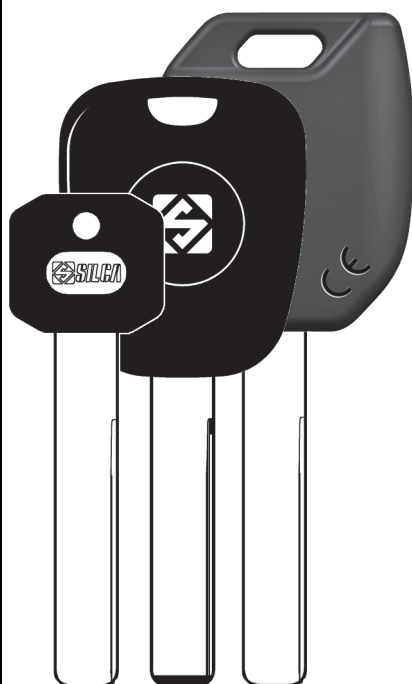

HU92RKP HU92RP HU92RMH



FUTURA

STANDARD



D943253ZR

01J Jaw
Ganascia 01J
01J Backe
Mâchoire 01J
Quijada 01J
Garra 01J

OPTIONAL



D743256ZB

04J Jaw
Ganascia 04J
04J Backe
Mâchoire 04J
Quijada 04J
Garra 04J

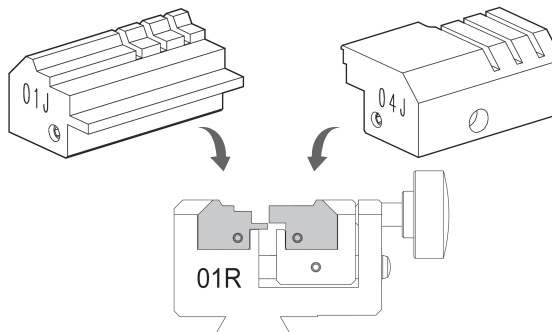

STANDARD



D742606ZB

Cutter 01L
Fresa 01L
Fräser 01L
Fraise 01L
Fresa 01L
Fresa 01L

Delivery time MARCH 2014
Disponibilità MARZO 2014
Lieferbar MÄRZ 2014
Disponibilité MARS 2014
Disponibilidad MARZO 2014
Disponibilidade MARÇO 2014

FOR:
PER:

CISA (I)

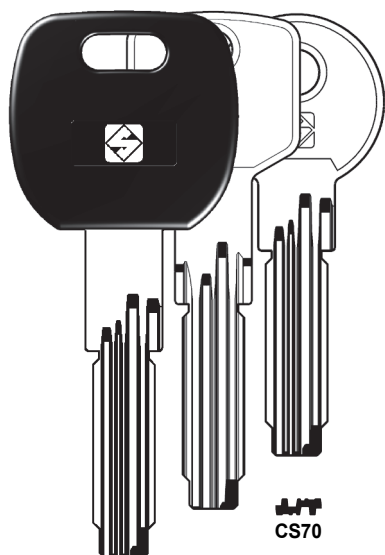

system 357



ASTRAL



ABUS



FUTURA

OPTIONAL D743261ZB



05J Jaw
Ganascia 05J
05J Backe
Mâchoire 05J
Quijada 05J
Garra 05J



OPTIONAL D743262ZB



06J Jaw
Ganascia 06J
06J Backe
Mâchoire 06J
Quijada 06J
Garra 06J

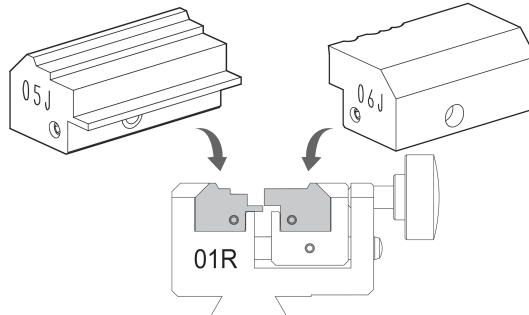

STANDARD



D742867ZB

Cutter 01D
Fresa 01D
Fräser 01D
Fraise 01D
Fresa 01D
Fresa 01D

Delivery time MARCH 2014
Disponibilità MARZO 2014
Lieferbar MÄRZ 2014
Disponibilité MARS 2014
Disponibilidad MARZO 2014
Disponibilidade MARÇO 2014

ASTRAL system:

Codes tables protected by a password issued by Silca on receipt of the manufacturer's authorization.

Tabella codici protette da password rilasciata da Silca a fronte di autorizzazione del costruttore.

Code-Tabellen geschützt durch von Silca geliefertes Password auf Herstellersgenehmigung.

Tables de codes protégées par un password qui est émis par Silca sur autorisation du Constructeur.

Tablas códigos protegidos por password que expide Silca contra autorización del constructor.

Tabelas de códigos protegidas por uma password emitida por Silca contra autorização do fabricante.

PER:
FOR:

CITROËN (F)



SX9GP

SX9T14

SX9MH

SX9AP

SX9T6

SX10BP

SX9TE

SX11BP

SX9EHP

SX9CP

VALEO - SIMPLEX (F)



FUTURA

OPTIONAL

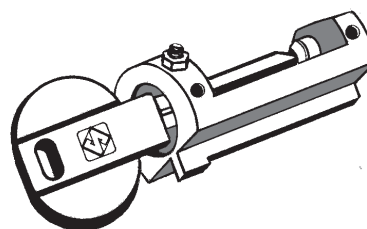

D708040ZB

Code adaptor B6 for SIMPLEX
Adattatore B6 a codice per chiavi SIMPLEX
Code-Adapter B6 für SIMPLEX Schlüssel
Adaptateur B6 à code pour clés SIMPLEX
Adaptador B6 a código para llaves SIMPLEX
Adaptador B6 por código para chaves SIMPLEX

PER:
FOR:

DOM (D) CORBIN (I)

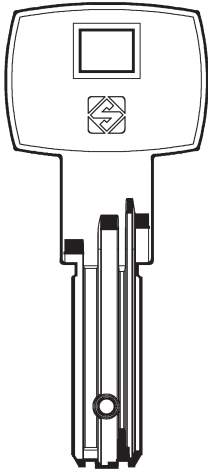

DM144

IX6 KG Profile 121



FUTURA

OPTIONAL



D743269ZB

09J Jaw
Ganascia 09J
09J Backe
Mâchoire 09J
Quijada 09J
Garra 09J



OPTIONAL



D743270ZB

10J Jaw
Ganascia 10J
10J Backe
Mâchoire 10J
Quijada 10J
Garra 10J

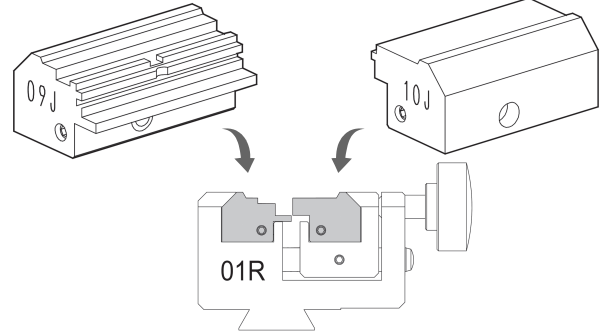

STANDARD



D742867ZB

Cutter 01D
Fresa 01D
Fräser 01D
Fraise 01D
Fresa 01D
Fresa 01D

Delivery time MARCH 2014
Disponibilità MARZO 2014
Lieferbar MÄRZ 2014
Disponibilit  MARS 2014
Disponibilidad MARZO 2014
Disponibilidade MARÇO 2014



PER:
FOR:

FORD (EU+USA)

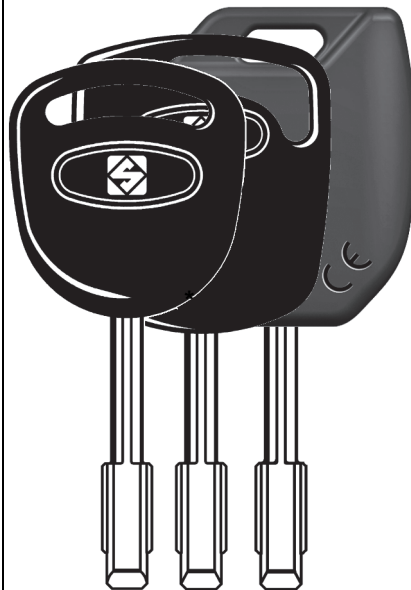

FUTURA

OPTIONAL



D743276ZB

03R Clamp
Morsetto 03R
03R Spannbacke
Etau 03R
Mordaza 03R
Mordente 03R

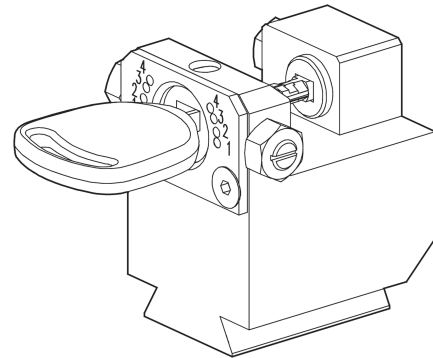

STANDARD



D742606ZB

Cutter 01L
Fresa 01L
Fräser 01L
Fraise 01L
Fresa 01L
Fresa 01L

Delivery time MARCH 2014
Disponibilità MARZO 2014
Lieferbar MÄRZ 2014
Disponibilit  MARS 2014
Disponibilidad MARZO 2014
Disponibilidade MARÇO 2014



- FO21P**
- FO21T3**
- FO21MH**
- FO21EH1**
- FO21EH2**
- FO21T3M**
- FO21T7**
- FO21T17**
- FO21TE**
- FO21FH**
- FO21AP**

TIBBE (D)
VALEO (F)

PER:
FOR:

HUF (D)

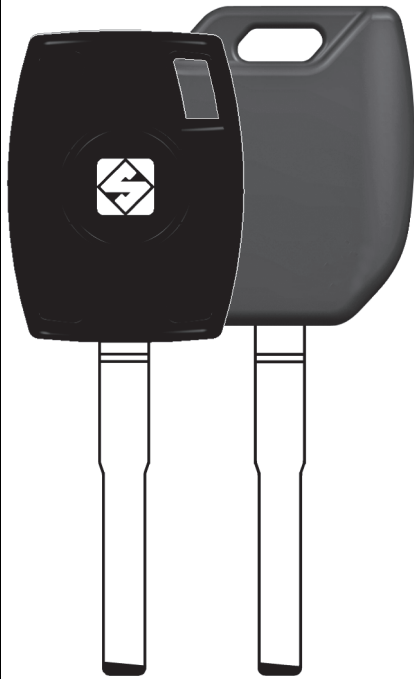

HU101T17
HU101T20
HU101TE

HU101MH
HU101T
HU101AP
HU101EH
HU101FH



FUTURA

OPTIONAL

D743255ZB



03J Jaw
 Ganascia 03J
 03J Backe
 Mâchoire 03J
 Quijada 03J
 Garra 03J



STANDARD

D943254ZR



02J Jaw
 Ganascia 02J
 02J Backe
 Mâchoire 02J
 Quijada 02J
 Garra 02J

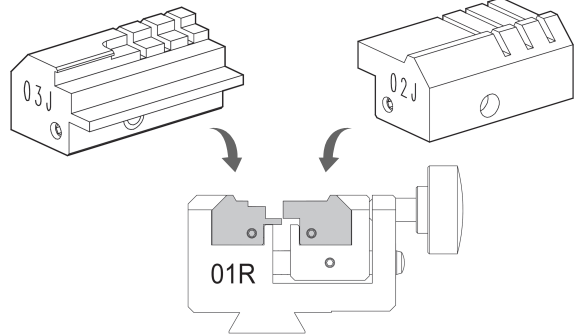

STANDARD

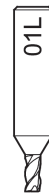

D742606ZB

Cutter 01L
 Fresa 01L
 Fräser 01L
 Fraise 01L
 Fresa 01L
 Fresa 01L

Delivery time MARCH 2014
 Disponibilit  MARZO 2014
 Lieferbar M RZ 2014
 Disponibilit  MARS 2014
 Disponibilidad MARZO 2014
 Disponibilidade MAR O 2014

PER:
FOR:

HUWIL (D)

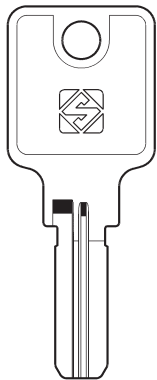

HW15R



FUTURA

OPTIONAL

D743362ZB



16J Jaw
 Ganascia 16J
 16J Backe
 M choire 16J
 Quijada 16J
 Garra 16J



OPTIONAL

D743365ZB



17J Jaw
 Ganascia 17J
 17J Backe
 M choire 17J
 Quijada 17J
 Garra 17J

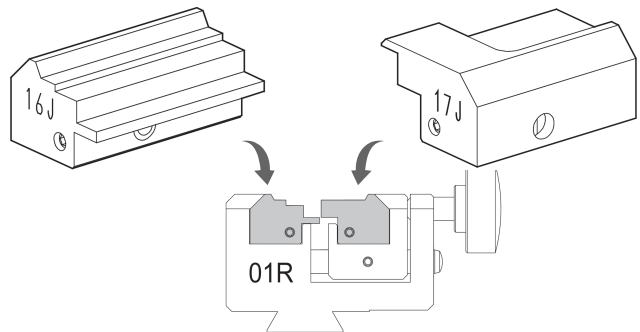

STANDARD



D742606ZB

Cutter 01L
 Fresa 01L
 Fr ser 01L
 Fraise 01L
 Fresa 01L
 Fresa 01L

Delivery time MARCH 2014
 Disponibilit  MARZO 2014
 Lieferbar M RZ 2014
 Disponibilit  MARS 2014
 Disponibilidad MARZO 2014
 Disponibilidade MAR O 2014

PER:
FOR:

ISEO (I)

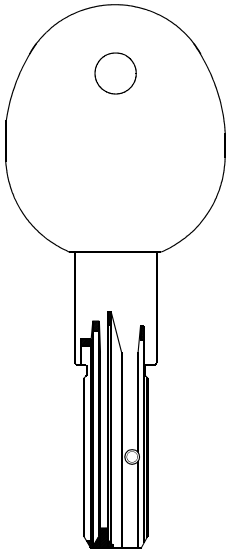

ISR100 WEB / R100 / R50



FUTURA

OPTIONAL



D743278ZB

11J Jaw
Ganascia 11J
11J Backe
Mâchoire 11J
Quijada 11J
Garra 11J

STANDARD D943254ZR



02J Jaw
Ganascia 02J
02J Backe
Mâchoire 02J
Quijada 02J
Garra 02J

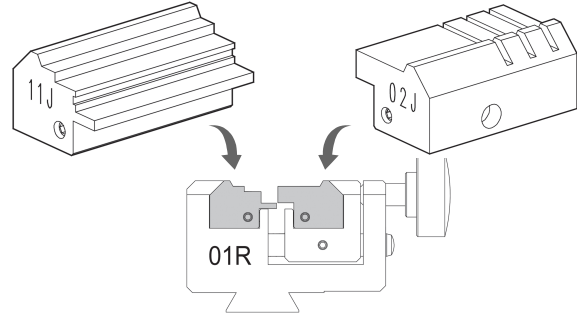

STANDARD



D742867ZB

Cutter 01D
Fresa 01D
Fräser 01D
Fraise 01D
Fresa 01D
Fresa 01D

Delivery time MARCH 2014
Disponibilità MARZO 2014
Lieferbar MÄRZ 2014
Disponibilité MARS 2014
Disponibilidad MARZO 2014
Disponibilidade MARÇO 2014

Codes tables protected by a password issued by Silca on receipt of the manufacturer's authorization.

Tabelle codici protette da password rilasciata da Silca a fronte di autorizzazione del costruttore.

Code-Tabellen geschützt durch von Silca geliefertes Password auf Herstellersgenehmigung.

Tables de codes protégées par un password qui est émis par Silca sur autorisation du Constructeur.

Tablas códigos protegidos por password que expide Silca contra autorización del constructor.

Tabelas de códigos protegidas por uma password emitida por Silca contra autorização do fabricante.

PER:
FOR:

KABA (CH)

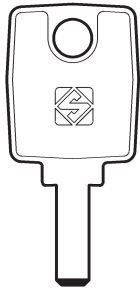

KA8

(KABA-MICRO)



FUTURA

OPTIONAL



D729845ZB

A18 adapter
Adattatore A18
Adapter A18
Adaptateur A18
Adaptador A18
Adaptador A18

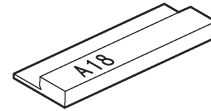

STANDARD



D943253ZR

01J Jaw
Ganascia 01J
01J Backe
Mâchoire 01J
Quijada 01J
Garra 01J

STANDARD



D943254ZR

02J Jaw
Ganascia 02J
02J Backe
Mâchoire 02J
Quijada 02J
Garra 02J

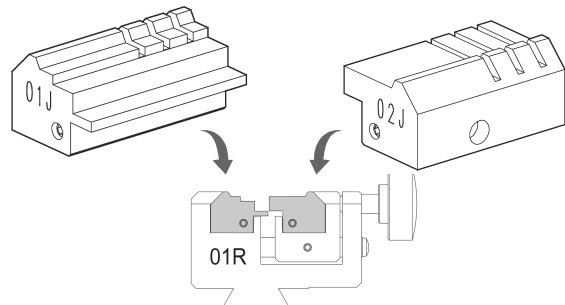

OPTIONAL



D743674ZB

Cutter 03D
Fresa 03D
Fräser 03D
Fraise 03D
Fresa 03D
Fresa 03D

Delivery time MARCH 2014
Disponibilità MARZO 2014
Lieferbar MÄRZ 2014
Disponibilité MARS 2014
Disponibilidad MARZO 2014
Disponibilidade MARÇO 2014

PER:
FOR:

KYR (I)

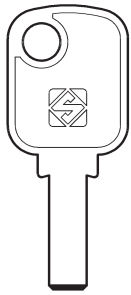

SCU1

SECURITAL



FUTURA

OPTIONAL



D729845ZB

A18 adapter
Adattatore A18
Adapter A18
Adaptateur A18
Adaptador A18
Adaptador A18

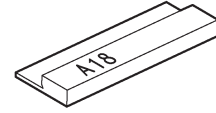

STANDARD **D943253ZR**



01J Jaw
Ganascia 01J
01J Backe
Mâchoire 01J
Quijada 01J
Garra 01J

STANDARD **D943254ZR**



02J Jaw
Ganascia 02J
02J Backe
Mâchoire 02J
Quijada 02J
Garra 02J

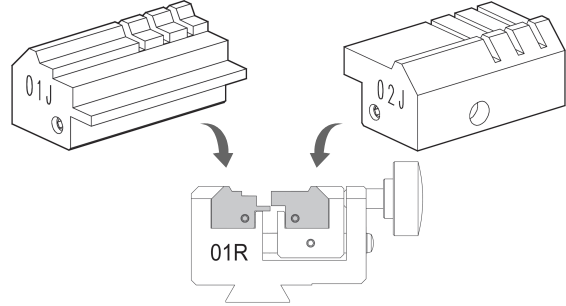

STANDARD



D742867ZB

Cutter 01D
Fresa 01D
Fräser 01D
Fraise 01D
Fresa 01D
Fresa 01D

Delivery time MARCH 2014
Disponibilità MARZO 2014
Lieferbar MÄRZ 2014
Disponibilit  MARS 2014
Disponibilidad MARZO 2014
Disponibilidade MARÇO 2014

PER:
FOR:

MERCEDES (D)

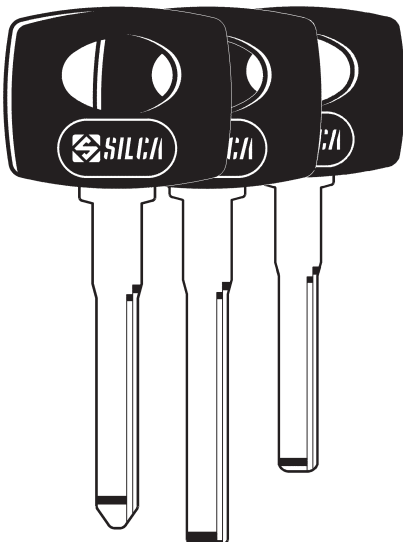

HU41P

HU55P

HU64P

HU61AP

HU64T

HU65AP

HUF (D)



FUTURA

STANDARD



STANDARD **D943253ZR**

01J Jaw
Ganascia 01J
01J Backe
Mâchoire 01J
Quijada 01J
Garra 01J

OPTIONAL **D743256ZB**



04J Jaw
Ganascia 04J
04J Backe
Mâchoire 04J
Quijada 04J
Garra 04J

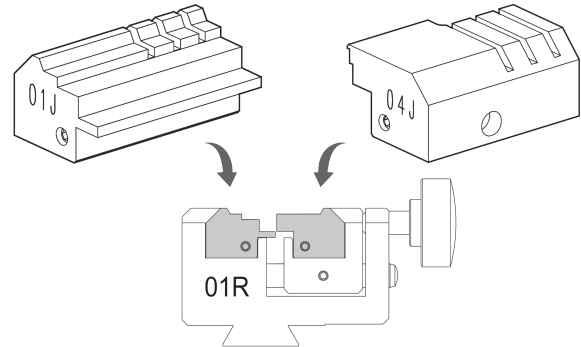

STANDARD



D742606ZB

Cutter 01L
Fresa 01L
Fräser 01L
Fraise 01L
Fresa 01L
Fresa 01L

Delivery time MARCH 2014
Disponibilità MARZO 2014
Lieferbar MÄRZ 2014
Disponibilit  MARS 2014
Disponibilidad MARZO 2014
Disponibilidade MARÇO 2014

PER:
FOR:

MERONI (I)

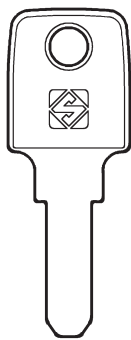

MER39

M4



FUTURA

OPTIONAL D743343ZB

- CODE
- ◊ COPY
- 14J Jaw
- Ganascia 14J
- 14J Backe
- Mâchoire 14J
- Quijada 14J
- Garra 14J

OPTIONAL D743361ZB

- CODE
- ◊ COPY
- 15J Jaw
- Ganascia 15J
- 15J Backe
- Mâchoire 15J
- Quijada 15J
- Garra 15J

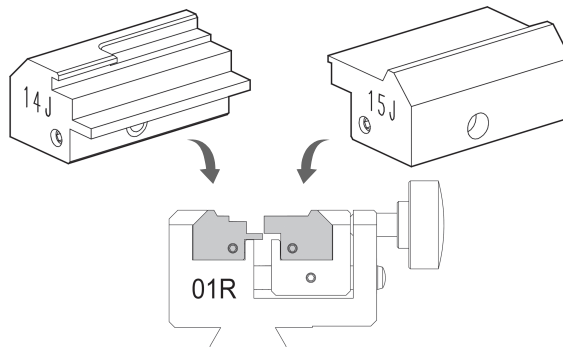

OPTIONAL



D743671ZB

- Cutter 02L
- Fresa 02L
- Fräser 02L
- Fraise 02L
- Fresa 02L
- Fresa 02L

Delivery time MARCH 2014
Disponibilità MARZO 2014
Lieferbar MÄRZ 2014
Disponibilit  MARS 2014
Disponibilidad MARZO 2014
Disponibilidade MARÇO 2014

PER:
FOR:

SECUREMME (I)

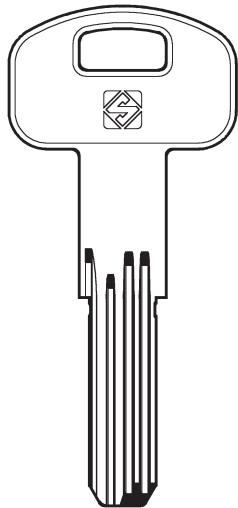

SCM2

K1



FUTURA

OPTIONAL D743341ZB

- CODE
- ◊ COPY
- 13J Jaw
- Ganascia 13J
- 13J Backe
- Mâchoire 13J
- Quijada 13J
- Garra 13J

STANDARD D943254ZR

- CODE
- ◊ COPY
- 02J Jaw
- Ganascia 02J
- 02J Backe
- Mâchoire 02J
- Quijada 02J
- Garra 02J

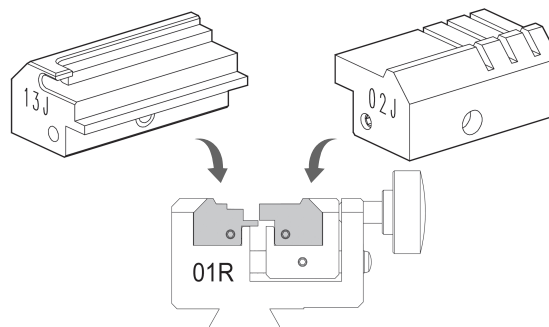

OPTIONAL



D743673ZB

- Cutter 02D
- Fresa 02D
- Fräser 02D
- Fraise 02D
- Fresa 02D
- Fresa 02D

Delivery time MARCH 2014
Disponibilit  MARZO 2014
Lieferbar MÄRZ 2014
Disponibilit  MARS 2014
Disponibilidad MARZO 2014
Disponibilidade MARÇO 2014

PER:
FOR: **SECUREMME (I)**

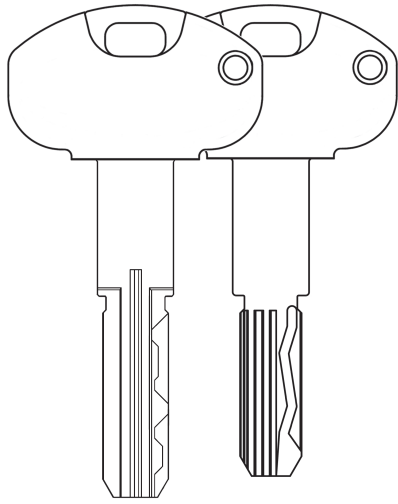

(K3)
5 pin

(K3)
5+5 pin



FUTURA

OPTIONAL

 CODE

 COPY

D743261ZB

05J Jaw
Ganascia 05J
05J Backe
Mâchoire 05J
Quijada 05J
Garra 05J

OPTIONAL

 CODE

 COPY

D743262ZB

06J Jaw
Ganascia 06J
06J Backe
Mâchoire 06J
Quijada 06J
Garra 06J

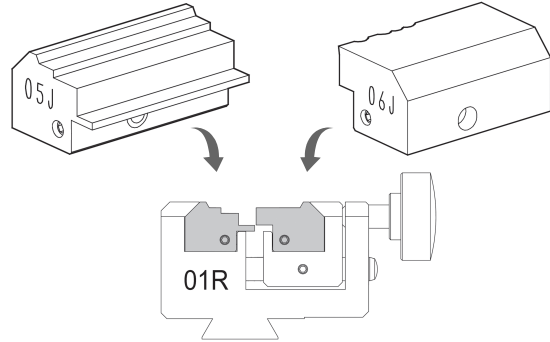

OPTIONAL



D743673ZB

Cutter 02D
Fresa 02D
Fräser 02D
Fraise 02D
Fresa 02D
Fresa 02D

Delivery time MARCH 2014
Disponibilit  MARZO 2014
Lieferbar M RZ 2014
Disponibilit  MARS 2014
Disponibilidad MARZO 2014
Disponibilidade MAR O 2014

PER:
FOR: **STS (E)**

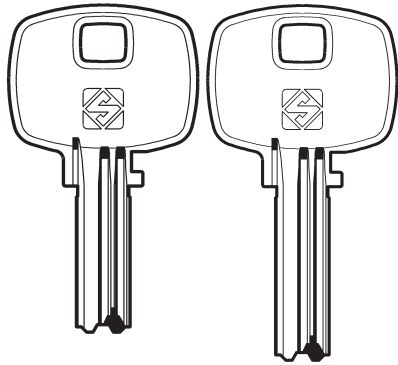

STS5

STS6



FUTURA

OPTIONAL

 CODE

 COPY

D743340ZB

12J Jaw
Ganascia 12J
12J Backe
Mâchoire 12J
Quijada 12J
Garra 12J

STANDARD

 CODE

 COPY

D943254ZR

02J Jaw
Ganascia 02J
02J Backe
Mâchoire 02J
Quijada 02J
Garra 02J

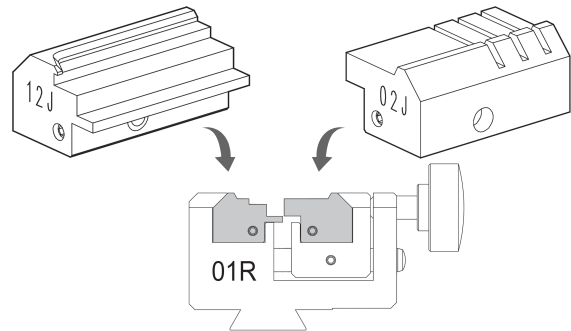

STANDARD



D742867ZB

Cutter 01D
Fresa 01D
Fräser 01D
Fraise 01D
Fresa 01D
Fresa 01D

Delivery time MARCH 2014
Disponibilit  MARZO 2014
Lieferbar M RZ 2014
Disponibilit  MARS 2014
Disponibilidad MARZO 2014
Disponibilidade MAR O 2014

PER: **TUBULAR KEYS**
 FOR: **CHIAVI TUBOLARI**
STECKSCHLÜSSEL
CLÉS TUBULAIRES
LLAVES TUBOLARES
CHAVES TUBULARES

AGA (E)
BILMA (E) BIL1T

CHICAGO (USA) CH9T
 CH16T (9.2)
 CH17T (10)

L&F (GB)
KENSTAN (USA) CH9T

MERONI (I) MER22T (9.50)
 MER25T (9.50)

P.CORTELLEZZI (I) PC12T (9.60)
 PC12TP (9.60)
 PC15T (9.60)
 PC15TP (9.60)

SILCA (I) SLC1TP (9.60)
 SLC2TP (9.60)



FUTURA

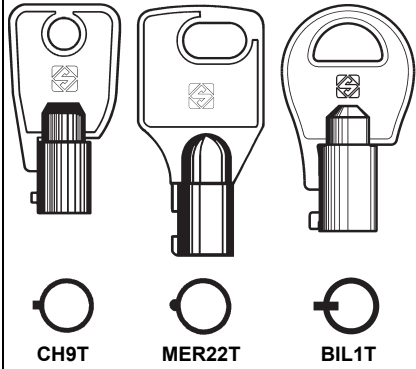

OPTIONAL



D743275ZB

02R Clamp
 Morsetto 02R
 02R Spannbacke
 Etau 02R
 Mordaza 02R
 Mordente 02R

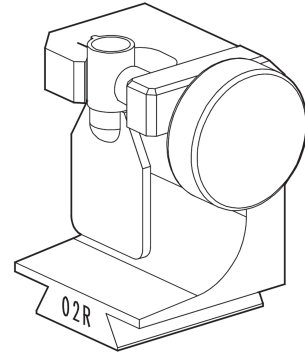

OPTIONAL



D743672ZB

Cutter 03L
 Fresa 03L
 Fräser 03L
 Fraise 03L
 Fresa 03L
 Fresa 03L









Delivery time MARCH 2014
 Disponibilità MARZO 2014
 Lieferbar MÄRZ 2014
 Disponibilit  MARZ 2014
 Disponibilidad MARZO 2014
 Disponibilidade MARÇO 2014

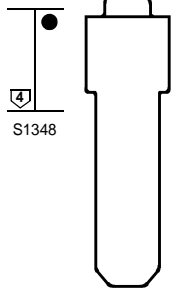
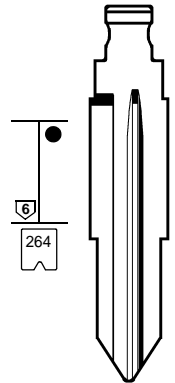
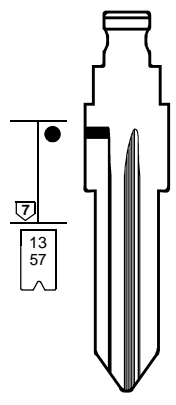
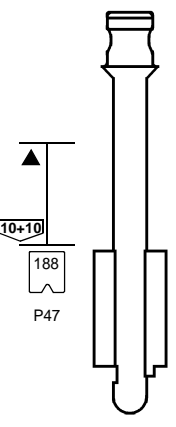



New keys / Chiavi Nuove / Neue Schlüssel / Nouvelles Clés
Llaves Nuevas / Chaves Nuevas





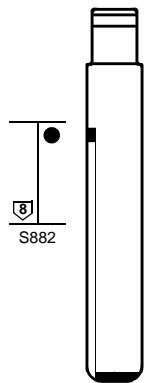
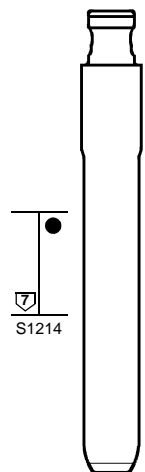
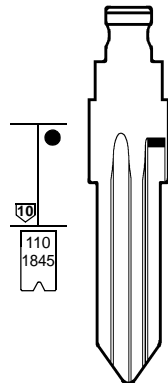
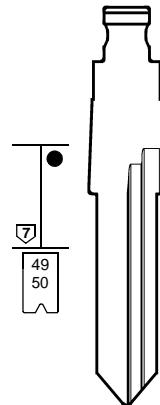

FOR: PER:	EVVA	LITTO	TRELOCK	GUARD	FOR / PER
	 1278 EV70 EV70R	 471 LT6R	 P467 TRK8DP 	 1278 GD10 GD10R	CHRYSLER (USA) EVVA (A) GUARD (CZ) HYUNDAI (ROK) KIA (ROK) LITTO (B) TRELOCK (D)
FOR: PER:	CHRYSLER	HYUNDAI	KIA		
	 P462 CY24TE Key with Adapter / without Transponder Chiave con Adattatore / senza Transponder Schlüssel mit Adapter / ohne Transponder Clé avec Adaptateur / sans Transpondeur Llaves con Adaptador / sin Transponder Chave com Adaptador / sem Transponder	 P455 HYN7RTE S 1-1000 Key with Adapter / without Transponder Chiave con Adattatore / senza Transponder Schlüssel mit Adapter / ohne Transponder Clé avec Adaptateur / sans Transpondeur Llaves con Adaptador / sin Transponder Chave com Adaptador / sem Transponder	 P463 KIA3RTE Y 2001-3000 Key with Adapter / without Transponder Chiave con Adattatore / senza Transponder Schlüssel mit Adapter / ohne Transponder Clé avec Adaptateur / sans Transpondeur Llaves con Adaptador / sin Transponder Chave com Adaptador / sem Transponder		

01
 COMMERCIAL GROUP
 GRUPPO COMMERCIALE
 PREISEGRUPPE
 GROUPE COMMERCIAL
 GRUPO COMMERCIAL
 GRUPO COMERCIAL
www.silca.biz

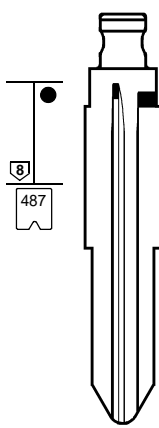
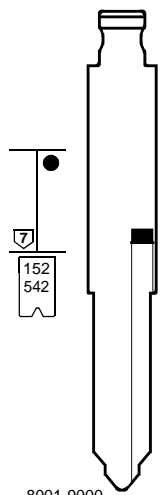
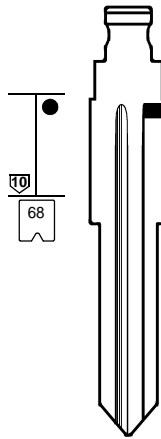
FOR / PER
BMW (D)
CHUBB (GB) +  FORD EU (2)
FORD (EU) CHUBB
GENERAL MOTORS (USA)
HUF (D)
HYUNDAI (J)
KAWASAKI (J)
NEIMAN (FR)

FOR: PER:	BMW	DAIHATSU	FORD EU	
				
	S1348	264	13 57	10+10 188 P47
	 BW9FH K 5001-8276	 DH5RFH D 1-3000	 FO10FH AK 1-1000 TL 1-1000 TX 1-1859	 FO19FH C 12345  
				CHUBB

FOR: PER:	GENERAL MOTORS	HUF		
				
	S882	S1214	110 1845	49 50
	 GM45FH 60000-62113	 HU134FH 00001-02300	 HU46FH S 5298-6300 S 1-5200	 HU49FH AH 1-8154 AH 1001-9282
				WITTE





FOR: PER:	HYUNDAI	KAWASAKI	NEIMAN
			
	487	152 542	68
	 HYN12FH A 1-1000	 KW14FH B 8001-9000 	 NE75FH L 8001-10000
	 HYN15FH WA 1001-3040		





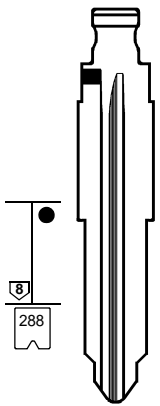
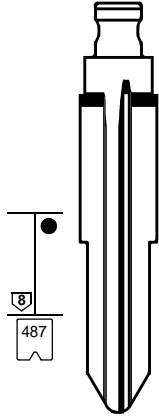
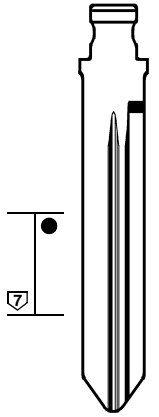
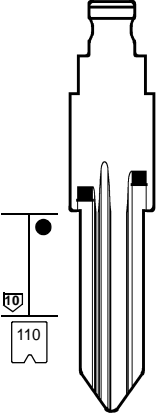

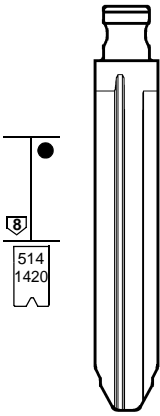
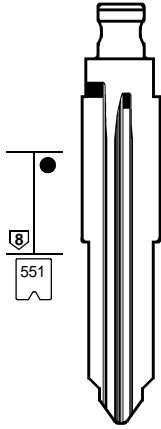
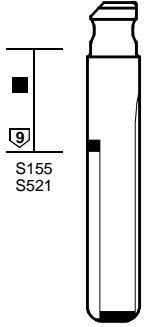
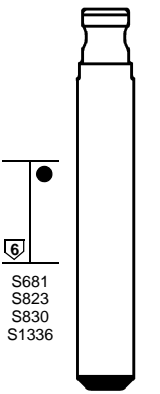
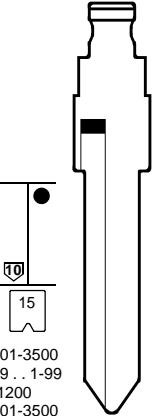
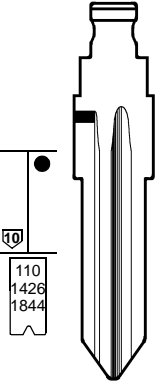





01
COMMERCIAL GROUP
GRUPPO COMMERCIALE
PREISEGRUPPE
GROUPE COMMERCIAL
GRUPO COMMERCIAL
GRUPO COMERCIAL

















FOR: PER:
Flip Keys



www.silca.biz

FOR: PER:	PROTON	SSANGYONG	SUZUKI	TATA	FOR / PER
	 <p>288</p> <p>PO1RFH 30010-32009</p>	 <p>487</p> <p>SSY3FH K..... 1-1000</p>	 <p>7</p> <p>SZ18FH SZ18RFH</p>	 <p>110</p> <p>TAT1FH T..... 1-1200 S..... 1-5200</p>	PROTON (MAL) SSANGYONG (ROK) SUZUKI (J) TATA (IND) TOYOTA (J) TRW SIPEA (I) VALEO (F) +  YMOS (3) YMOS (D) VALEO
FOR: PER:	TOYOTA		TRW SIPEA		
	 <p>514 1420</p> <p>TOY43RFH 1001-15000 70000-75928</p>	 <p>551</p> <p>TOY46RFH N..... 1-2000</p>	 <p>S155 S521</p> <p>SIP16FH 1-17735 LA..... 1-17735</p>		
FOR: PER:	VALEO	YMOS			
	 <p>S681 S823 S830 S1336</p> <p>VA2FH 1234Q5678H ABCDE</p>	 <p>15</p> <p>NM..... 2501-3500 .. NF .. 1-99 .. 1-99 HM..... 1-1200 HM..... 2501-3500 HM..... 4001-7350 HF..... 1-1200</p> <p>YM15FH</p>	 <p>110 1426 1844</p> <p>YM28FH D..... 1-5200 1002-3997 4000-5874 D..... 1-5200</p>		
					01 COMMERCIAL GROUP GRUPPO COMMERCIALE PREISEGRUPPE GROUPE COMMERCIAL GRUPO COMMERCIAL GRUPO COMERCIAL
					FOR: PER: Flip Keys  www.silca.biz













1	2	2a	3	3a	3b	E1+E2		6	42+71	72	43 44a	12	15
						GTI Compatibility							
CAR MAKE/MODEL 	FROM 1995	TO 2014	SILCA REF.  Ref.	SILCA REF.  "TE" Silca Ref.	SILCA REF.  "Flip Keys" Silca Ref.	COPY 	GEN. 	TRANSP. TYPE 	ID  FAST COPY PLUS RW4 PLUS FAST COPY/RW4	COPY  FAST COPY PLUS RW4 PLUS	COPY  FAST COPY RW4	STP 	
ACURA®													
MDX	2007	2013	HON66EHP					PH/CR2	46	Y	P-BOX		
MDX	2007	2013	HON66MH		HON66FH*	Y	Y	PH/CR2	46	Y	P-BOX		
MDX	2007	2013	HON66T14					PH/CR2	46				
MDX	2014		SMART KEY					PH/CR2	46				
RDX	2007	2012	HON66EHP					PH/CR2	46	Y	P-BOX		
RDX	2007	2012	HON66MH		HON66FH*	Y	Y	PH/CR2	46	Y	P-BOX		
RDX	2007	2012	HON66T14					PH/CR2	46				
RLX	2014		SMART KEY					PH/CR2	46				
TL	2009		SMART KEY					PH/CR2	46				
ZDX	2010	2013	SMART KEY					PH/CR2	46				
ALFA ROMEO®													
166	2000	2004	SIP16MH		SIP16FH*	Y		PH/CR2	46	Y	P-BOX		
AUDI®													
80	1996		HU49AT5		HU49FH*			MEG	13	Y	Y	MEG	
A4	1995	1996	HU49AT5		HU49FH*			MEG	13	Y	Y	MEG	
A6	1995	1996	HU49AT5		HU49FH*			MEG	13	Y	Y	MEG	
A8	1995	1996	HU49AT5		HU49FH*			MEG	13	Y	Y	MEG	
CABRIO	1995	1996	HU49AT5		HU49FH*			MEG	13	Y	Y	MEG	
COUPÉ	1995	1996	HU49AT5		HU49FH*			MEG	13	Y	Y	MEG	
COUPÉ S2	1995	1996	HU49AT5		HU49FH*			MEG	13	Y	Y	MEG	
S6	1995	1996	HU49AT5		HU49FH*			MEG	13	Y	Y	MEG	
BUICK®													
ALLURE	2010	2012	HU100EHP					PH/CR2	46	Y	P-BOX		
ALLURE	2010	2012	HU100MH	HU100TE	HU100FH*	Y		PH/CR2	46	Y	P-BOX		
LUCERNE	2006	2011	B111-PT					PH/CR2	46				
CADILLAC®													
CATERA	1997	2000	HU46T2		HU46FH*			PH	33	Y	Y	S-O	
CTS	2008	2013	B111-PT					PH/CR2	46				G
CHEVROLET S. AMERICA®													
ASTRA	2001	2007	HU46T12		HU46FH*			PH/CR	40				
CELTA			YM28CP		YM28FH*								
CELTA	2000		HU46T12		HU46FH*			PH/CR	40				
CORSA HATCH	2000		HU46T12		HU46FH*			PH/CR	40				
CORSA	1995	1998	HU46T2		HU46FH*			PH	33	Y	Y	S-O	
CORSA	1995	1998	YM28T2		YM28FH*			PH	33	Y	Y	S-O	
CORSA	1998	1999	YM28T2		YM28FH*			PH/CR	40	RD	RD		

1	2	2a	3	3a	3b	E1+E2		6	42+71	72	43 44a	12	15
						GTI Compatibility							
CAR MAKE/MODEL 	FROM 1995 	TO 2014 	SILCA REF.  Ref.	SILCA REF.  "TE" Silca Ref.	 SILCA REF.  "Flip Keys" Silca Ref.	COPY 	GEN. 	TRANSP. TYPE 	ID  FAST COPY PLUS RW4 PLUS FAST COPY/RW4	COPY  FAST COPY PLUS RW4 PLUS	COPY  FAST COPY RW4	STP  	
CHEVROLET S. AMERICA®													
CORSA	1998	1999	HU46T9		HU46FH*			PH/CR	40				
CORSA	1998	1999	HU46T2		HU46FH*			PH/CR	40	RD	RD		
CORSA	2000		HU46T12		HU46FH*			PH/CR	40				
MERIVA	2002		HU46T12		HU46FH*			PH/CR	40				
MONTANA	2003		HU46T12		HU46FH*			PH/CR	40				
PRISMA	2006		HU46T12		HU46FH*			PH/CR	40				
VECTRA	2005		HU46T12		HU46FH*			PH/CR	40				
ZAFIRA	1999	2000	HU46T9		HU46FH*			PH/CR	40				
ZAFIRA	1999	2000	HU46T2		HU46FH*			PH/CR	40	RD	RD		
ZAFIRA	2001	2005	HU46T12		HU46FH*			PH/CR	40				
CHEVROLET USA®													
AVALANCHE	2007	2013	B111-PT					PH/CR2	46				A
CAPRICE PPV	2011	2013	GM45MH		GM45FH*	Y		PH/CR2	46	Y	P-BOX		
COLORADO	2004	2012	TOY43R		TOY43RFH*								
COLORADO	2004	2012	TOY43RP		TOY43RFH*								
CORVETTE	2005	2013	SMART KEY					PH/CR2	46				
IMPALA	2006	2013	B111-PT					PH/CR2	46				
IMPALA	2014		HU100MH	HU100TE	HU100FH*			PH/CR2	46	Y	P-BOX		
IMPALA	2014							PH/CR2	46				
ORLANDO	2012	2013	HU100MH	HU100TE	HU100FH*	Y		PH/CR2	46	Y	P-BOX		
ORLANDO	2012	2013						PH/CR2	46				
SILVERADO	2007	2013	B111-PT					PH/CR2	46				A
SILVERADO	2004	2006	TOY43R		TOY43RFH*								
SILVERADO	2004	2006	TOY43RP		TOY43RFH*								
SILVERADO	2014		HU100MH	HU100TE	HU100FH*			PH/CR2	46	Y	P-BOX		
SILVERADO	2014							PH/CR2	46				
CHRYSLER®													
200	2011		CY24MH	CY24TE	CY24FH*	Y	Y	PH/CR2	46	Y	P-BOX		
300	1998	2004	CY24MH	CY24TE	CY24FH*	Y	Y	TEX/CR	64	Y	P-BOX		
300	2005	2008	CY24MH	CY24TE	CY24FH*	Y	Y	PH/CR2	46	Y	P-BOX		
ASPEN	2007	2009	CY24MH	CY24TE	CY24FH*	Y	Y	PH/CR2	46	Y	P-BOX		
CIRRUS CONVERTIBLE	2001	2002	CY24MH	CY24TE	CY24FH*	Y	Y	TEX/CR	64	Y	P-BOX		
CIRRUS SEDAN	2001	2002	CY24MH	CY24TE	CY24FH*	Y	Y	TEX/CR	64	Y	P-BOX		
CIRRUS	1999	2000	CY24MH	CY24TE	CY24FH*	Y	Y	TEX/CR	64	Y	P-BOX		
CONCORDE	1998	2004	CY24MH	CY24TE	CY24FH*	Y	Y	TEX/CR	64	Y	P-BOX		
LHS	1999	2001	CY24MH	CY24TE	CY24FH*	Y	Y	TEX/CR	64	Y	P-BOX		

* Blade for "Flip" Key plastic head

See info on the uses of the keys on Silca Electronic Keys Catalogue















1	2	2a	3	3a	3b	E1+E2		6	42+71	72	43 44a	12	15	
CAR MAKE/MODEL 	FROM 1995	TO 2014	SILCA REF.  Ref.	SILCA REF.  "TE" Silca Ref.	SILCA REF.  "Flip Keys" Silca Ref.	COPY 	GEN. 	TRANSP. TYPE 	ID  FAST COPY PLUS RW4 PLUS FAST COPY/RW4	COPY  FAST COPY PLUS RW4 PLUS	COPY  FAST COPY RW4	STP  	IGNITION 	
													GTI Compatibility	
CHRYSLER®														
NEON	2000	2005	CY24MH	CY24TE	CY24FH*	Y	Y	TEX/CR	64	Y	P-BOX			
NEW YORKER	1998	2001	CY24MH	CY24TE	CY24FH*	Y	Y	TEX/CR	64	Y	P-BOX			
PACIFICA	2004	2008	CY24MH	CY24TE	CY24FH*	Y	Y	PH/CR2	46	Y	P-BOX			
PT CRUISER LE	2001	2005	CY24MH	CY24TE	CY24FH*	Y	Y	TEX/CR	64	Y	P-BOX			
PT CRUISER	2001	2005	CY24MH	CY24TE	CY24FH*	Y	Y	TEX/CR	64	Y	P-BOX			
PT CRUISER	2006	2011	CY24MH	CY24TE	CY24FH*	Y	Y	PH/CR2	46	Y	P-BOX			
SEBRING CONVERT	2001	2006	CY24MH	CY24TE	CY24FH*	Y	Y	TEX/CR	64	Y	P-BOX			
SEBRING CONVERT	2007	2011	CY24MH	CY24TE	CY24FH*	Y	Y	PH/CR2	46	Y	P-BOX			
SEBRING SEDAN	1999	2006	CY24MH	CY24TE	CY24FH*	Y	Y	TEX/CR	64	Y	P-BOX			
SEBRING	2007	2011	CY24MH	CY24TE	CY24FH*	Y	Y	PH/CR2	46	Y	P-BOX			
STRATUS	1998	2006	CY24MH	CY24TE	CY24FH*	Y	Y	TEX/CR	64	Y	P-BOX			
TOWN & COUNTRY	2001	2004	CY24MH	CY24TE	CY24FH*	Y	Y	TEX/CR	64	Y	P-BOX			
TOWN & COUNTRY	2004	2007	CY24MH	CY24TE	CY24FH*	Y	Y	PH/CR2	46	Y	P-BOX			
VISION	1998		CY24MH	CY24TE	CY24FH*	Y	Y	TEX/CR	64	Y	P-BOX			
VOYAGER	1998	2003	CY24MH	CY24TE	CY24FH*	Y	Y	TEX/CR	64	Y	P-BOX			
VOYAGER	2004	2007	CY24MH	CY24TE	CY24FH*	Y	Y	PH/CR2	46	Y	P-BOX			
CITROËN®														
JUMPER	1996	2001	GT10BT5	GT10BTE	GT10FH*			MEG	13	Y	Y	MEG	S1	
RELAY	1996	2001	GT10BT5	GT10BTE	GT10FH*			MEG	13	Y	Y	MEG	S1	
DAIHATSU®														
CUORE	1995	1998	DH5RP		DH5RFH*									
CUORE	1998	2006	DH5RMH		DH5RFH*	Y	Y	TEXAS	4C	Y	P-BOX			
MOVE	1997	2002	DH5RMH		DH5RFH*	Y	Y	TEXAS	4C	Y	P-BOX			
DODGE®														
AVENGER	2008		CY24MH	CY24TE	CY24FH*	Y	Y	PH/CR2	46	Y	P-BOX			
CALIBER	2007	2012	CY24MH	CY24TE	CY24FH*	Y	Y	PH/CR2	46	Y	P-BOX			
CARAVAN	2001	2003	CY24MH	CY24TE	CY24FH*	Y	Y	TEX/CR	64	Y	P-BOX			
CARAVAN	2004	2007	CY24MH	CY24TE	CY24FH*	Y	Y	PH/CR2	46	Y	P-BOX			
CHARGER	2005	2008	CY24MH	CY24TE	CY24FH*	Y	Y	PH/CR2	46	Y	P-BOX			
DAKOTA	2001	2004	CY24MH	CY24TE	CY24FH*	Y	Y	TEX/CR	64	Y	P-BOX			
DAKOTA	2005	2011	CY24MH	CY24TE	CY24FH*	Y	Y	PH/CR2	46	Y	P-BOX			
DURANGO	2001	2004	CY24MH	CY24TE	CY24FH*	Y	Y	TEX/CR	64	Y	P-BOX			
DURANGO	2005	2009	CY24MH	CY24TE	CY24FH*	Y	Y	PH/CR2	46	Y	P-BOX			
INTREPID SEDAN, ES	2001	2004	CY24MH	CY24TE	CY24FH*	Y	Y	TEX/CR	64	Y	P-BOX			
INTREPID	1998	2004	CY24MH	CY24TE	CY24FH*	Y	Y	TEX/CR	64	Y	P-BOX			
MAGNUM	2005	2008	CY24MH	CY24TE	CY24FH*	Y	Y	PH/CR2	46	Y	P-BOX			

* Blade for "Flip" Key plastic head

See info on the uses of the keys on Silca Electronic Keys Catalogue



















1	2	2a	3	3a	3b	E1+E2		6	42+71	72	43 44a	12	15
CAR MAKE/MODEL 	FROM	TO	SILCA REF.	SILCA REF.	 SILCA REF.	COPY	GEN.	TRANSP. TYPE	ID	COPY	COPY	STP	
	1995	2014	 Ref.	 "TE" Silca Ref.	 "Flip Keys" Silca Ref.								
DODGE®													
NEON	2000	2005	CY24MH	CY24TE	CY24FH*	Y	Y	TEX/CR	64	Y	P-BOX		
NITRO	2007	2012	CY24MH	CY24TE	CY24FH*	Y	Y	PH/CR2	46	Y	P-BOX		
RAM	2002	2005	CY24MH	CY24TE	CY24FH*	Y	Y	TEX/CR	64	Y	P-BOX		
RAM	2006	2011	CY24MH	CY24TE	CY24FH*	Y	Y	PH/CR2	46	Y	P-BOX		
SPRINTER	2003	2006	YM15T5		YM15FH*			TEMIC	12	Y	Y		
STRATUS SEDAN	1998	2006	CY24MH	CY24TE	CY24FH*	Y	Y	TEX/CR	64	Y	P-BOX		
EAGLE®													
VISION	1998		CY24MH	CY24TE	CY24FH*	Y	Y	TEX/CR	64	Y	P-BOX		
FIAT®													
CINQUECENTO	1995	1996	GT10BT5	GT10BTE	GT10FH*			MEG	13	Y	Y	MEG	S1
CROMA	1995	1997	GT10BT5	GT10BTE	GT10FH*			PH	33	Y	Y	B-F	S1
DUCATO	1996	2001	GT10BT5	GT10BTE	GT10FH*			MEG	13	Y	Y	MEG	S1
FIORINO	1995	2002	GT10BT5	GT10BTE	GT10FH*			TEMIC	11	Y	Y	T-F	S1
PANDA	1995	2002	GT10BT5	GT10BTE	GT10FH*			MEG	13	Y	Y	MEG	S1
FORD SUD AMERICA®													
C-MAX	2004	2007	FO10MH	FO10TE	FO10FH*	Y	Y	TEX/CR	60	Y	P-BOX		
ECO-SPORT	2003	2007	FO10MH	FO10TE	FO10FH*	Y	Y	TEX/CR	60	Y	P-BOX		
FIESTA MAX	2005		FO10MH	FO10TE	FO10FH*	Y	Y	TEX/CR	60	Y	P-BOX		
FIESTA	2003		FO10MH	FO10TE	FO10FH*	Y	Y	TEX/CR	60	Y	P-BOX		
FORD USA®													
C-MAX	2013		HU101T20					TEX/MA	6E				
C-MAX	2013		SMART KEY					TEX/MA	6E				
GMC (GM)®													
CANYON	2004	2012	TOY43R		TOY43RFH*								
HOLDEN®													
ASTRA	1995	1998	HU46T2		HU46FH*			PH	33	Y	Y	S-O	
ASTRA	1995	1998	YM28T2		YM28FH*			PH	33	Y	Y	S-O	
ASTRA	1998	2001	HU46T9		HU46FH*			PH/CR	40				
ASTRA	1998	2000	HU46T2		HU46FH*			PH/CR	40	RD	RD		
ASTRA	2001	2004	HU46T12		HU46FH*			PH/CR	40				
BARINA	1994	1995	HU46		HU46FH*								
BARINA	1994	1995	HU46P		HU46FH*								
BARINA	1995	1998	HU46T2		HU46FH*			PH	33	Y	Y	S-O	
BARINA	1995	1998	YM28T2		YM28FH*			PH	33	Y	Y	S-O	
BARINA	1998	1999	HU46T9		HU46FH*			PH/CR	40				
BARINA	1998	1999	HU46T2		HU46FH*			PH/CR	40	RD	RD		

* Blade for "Flip" Key plastic head

See info on the uses of the keys on Silca Electronic Keys Catalogue



















1	2	2a	3	3a	3b	E1+E2		6	42+71	72	43 44a	12	15
						GT1 Compatibility							
CAR MAKE/MODEL 	FROM 1995 	TO 2014 	SILCA REF.  Ref.	SILCA REF.  "TE" Silca Ref.	 SILCA REF.  "Flip Keys" Silca Ref.	COPY 	GEN. 	TRANSP. TYPE 	ID  FAST COPY PLUS RW4 PLUS FAST COPY/RW4	COPY  FAST COPY PLUS RW4 PLUS	COPY  FAST COPY RW4	STP  	
HOLDEN®													
BARINA	1998	1999	YM28T2		YM28FH*			PH/CR	40	RD	RD		
COLORADO	2008		TOY43RMH		TOY43RFH*	Y	Y	PH/CR2	46	Y	P-BOX		
COMBO	1998	2001	HU46T2		HU46FH*			PH	33	Y	Y	S-O	
COMMODORE VE	2006		GM45MH		GM45FH*	Y		PH/CR2	46	Y	P-BOX		
HYUNDAI®													
GRANDEUR XG (AUS)	1998	2005	HYN7RMH	HYN7RTE	HYN7RFH*	Y	Y	TEX/CR	60	Y	P-BOX		
SANTAFE	2000	2002	HYN7RMH	HYN7RTE	HYN7RFH*	Y	Y	TEX/CR	60	Y	P-BOX		
SONATA	1996	1998	HYN7RMH	HYN7RTE	HYN7RFH*	Y	Y	TEXAS	4C	Y	P-BOX		
SONATA	1998	2004	HYN7RMH	HYN7RTE	HYN7RFH*	Y	Y	TEX/CR	60	Y	P-BOX		
SONICA	1996	1998	HYN7RMH	HYN7RTE	HYN7RFH*	Y	Y	TEXAS	4C	Y	P-BOX		
SONICA	1999	2004	HYN7RMH	HYN7RTE	HYN7RFH*	Y	Y	TEX/CR	60	Y	P-BOX		
STAREX	1998	2006	HYN12MH		HYN12FH*	Y	Y	TEXAS	4C	Y	P-BOX		
STAREX	1998	2006	HYN12CP		HYN12FH*								
TRAJET	2000	2006	HYN7RMH	HYN7RTE	HYN7RFH*	Y	Y	TEX/CR	60	Y	P-BOX		
XG25/XG30	1998	2005	HYN7RMH	HYN7RTE	HYN7RFH*	Y	Y	TEX/CR	60	Y	P-BOX		
XG300 (CANADA)	1998	2005	HYN7RMH	HYN7RTE	HYN7RFH*	Y	Y	TEX/CR	60	Y	P-BOX		
ISUZU®													
D-MAX	2002	2006	TOY43R		TOY43RFH*								
D-MAX	2002	2006	TOY43RP		TOY43RFH*								
D-MAX	2007		TOY43RMH		TOY43RFH*	Y	Y	PH/CR2	46	Y	P-BOX		
I-280	2006	2007	TOY43RP		TOY43RFH*								
I-290	2007		TOY43RP		TOY43RFH*								
I-350	2006	2007	TOY43RP		TOY43RFH*								
I-370	2007		TOY43RP		TOY43RFH*								
SOME MODELS			TOY43R		TOY43RFH*								
SOME MODELS			TOY43RP		TOY43RFH*								
IVECO®													
35C11	2000		GT10MH	GT10BTE	GT10FH*	Y		PH / CR2	46	Y	P-BOX		
EUROSTAR	1998	2002	GT10MH	GT10BTE	GT10FH*	Y		PH / CR2	46	Y	P-BOX		
NEW DAILY	1998		GT10MH	GT10BTE	GT10FH*	Y		PH / CR2	46	Y	P-BOX		
S-2000	1998		GT10MH	GT10BTE	GT10FH*	Y		PH / CR2	46	Y	P-BOX		
JEEP®													
CHEROKEE LIMITED	1999	2005	CY24MH	CY24TE	CY24FH*	Y	Y	TEX/CR	64	Y	P-BOX		
CHEROKEE	1998	2004	CY24MH	CY24TE	CY24FH*	Y	Y	TEX/CR	64	Y	P-BOX		
CHEROKEE	2005		CY24MH	CY24TE	CY24FH*	Y	Y	PH/CR2	46	Y	P-BOX		

* Blade for "Flip" Key plastic head

See info on the uses of the keys on Silca Electronic Keys Catalogue













1	2	2a	3	3a	3b	E1+E2		6	42+71	72	43 44a	12	15
						GTI Compatibility			IGNITION 				
CAR MAKE/MODEL 	FROM 1995 	TO 2014 	SILCA REF.  Ref.	SILCA REF.  "TE" Silca Ref.	 SILCA REF.  "Flip Keys" Silca Ref.	COPY 	GEN. 	TRANSP. TYPE 	ID  FAST COPY PLUS RW4 PLUS FAST COPY/RW4	COPY  FAST COPY PLUS RW4 PLUS	COPY  FAST COPY RW4	STP  	
JEEP®													
CJ5,CJ7	1998	2005	CY24MH	CY24TE	CY24FH*	Y	Y	TEX/CR	64	Y	P-BOX		
CJ5,CJ7	2006		CY24MH	CY24TE	CY24FH*	Y	Y	PH/CR2	46	Y	P-BOX		
COMANCHE	2006		CY24MH	CY24TE	CY24FH*	Y	Y	PH/CR2	46	Y	P-BOX		
COMMANDER	2006	2008	CY24MH	CY24TE	CY24FH*	Y	Y	PH/CR2	46	Y	P-BOX		
COMPASS	2007		CY24MH	CY24TE	CY24FH*	Y	Y	PH/CR2	46	Y	P-BOX		
G. CHEROKEE	2005	2008	CY24MH	CY24TE	CY24FH*	Y	Y	PH/CR2	46	Y	P-BOX		
G.CHEROKEE LUX	1999	2005	CY24MH	CY24TE	CY24FH*	Y	Y	TEX/CR	64	Y	P-BOX		
G.CHEROKEE SPORT	1998	2004	CY24MH	CY24TE	CY24FH*	Y	Y	TEX/CR	64	Y	P-BOX		
LIBERTY	2002	2004	CY24MH	CY24TE	CY24FH*	Y	Y	TEX/CR	64	Y	P-BOX		
LIBERTY	2005		CY24MH	CY24TE	CY24FH*	Y	Y	PH/CR2	46	Y	P-BOX		
PATRIOT	2007		CY24MH	CY24TE	CY24FH*	Y	Y	PH/CR2	46	Y	P-BOX		
WRANGLER	1998	2006	CY24MH	CY24TE	CY24FH*	Y	Y	TEX/CR	64	Y	P-BOX		
WRANGLER	2006		CY24MH	CY24TE	CY24FH*	Y	Y	PH/CR2	46	Y	P-BOX		
KIA®													
CARENS	2001	2006	KIA3RMH	KIA3RTE	KIA3RFH*	Y	Y	TEX/CR	60	Y	P-BOX		
CARENS	2001	2006	KIA3RMH	KIA3RTE	KIA3RFH*	Y	Y	PH/CR2	46	Y	P-BOX		
CARNIVAL	2002	2005	KIA3RMH	KIA3RTE	KIA3RFH*	Y	Y	PH/CR2	46	Y	P-BOX		
CLARUS	1998	2001	KIA3RT5	KIA3RTE	KIA3RFH*			MEG	13	Y	Y		
JOICE	2000	2003	KIA3RMH	KIA3RTE	KIA3RFH*	Y	Y	TEX/CR	60	Y	P-BOX		
MAGENTIS	2001	2006	KIA3RMH	KIA3RTE	KIA3RFH*	Y	Y	PH/CR2	46	Y	P-BOX		
MENTOR	2002	2004	KIA3RMH	KIA3RTE	KIA3RFH*	Y	Y	PH/CR2	46	Y	P-BOX		
OPTIMA	2001	2006	KIA3RMH	KIA3RTE	KIA3RFH*	Y	Y	PH/CR2	46	Y	P-BOX		
RIO	2001	2005	KIA3RMH	KIA3RTE	KIA3RFH*	Y	Y	TEX/CR	60	Y	P-BOX		
RIO	2006	2009	HYN15MH		HYN15FH*	Y	Y	PH/CR2	46	Y	P-BOX		
RONDO	2001	2006	KIA3RMH	KIA3RTE	KIA3RFH*	Y	Y	TEX/CR	60	Y	P-BOX		
SEDONA	2002	2005	KIA3RMH	KIA3RTE	KIA3RFH*	Y	Y	PH/CR2	46	Y	P-BOX		
SEPHIA	2002	2004	KIA3RMH	KIA3RTE	KIA3RFH*	Y	Y	PH/CR2	46	Y	P-BOX		
SHUMA	1998	2001	KIA3RT5	KIA3RTE	KIA3RFH*			MEG	13	Y	Y		
SORENTO	2002	2009	HYN7RMH	HYN7RTE	HYN7RFH*	Y	Y	PH/CR2	46	Y	P-BOX		
SPORTAGE	1998	1999	KIA3RT5	KIA3RTE	KIA3RFH*			MEG	13	Y	Y		
SPORTAGE	2001	2003	KIA3RMH	KIA3RTE	KIA3RFH*	Y	Y	TEX/CR	60	Y	P-BOX		
VENGA	2010		HU134MH		HU134FH*	Y	Y	PH/CR2	46	Y	P-BOX		
LANCIA®													
K	1995	2001	SIP16T2		SIP16FH*			PH	33	Y	Y	B-F	S1
K COUPÉ	1997	2001	SIP16T2		SIP16FH*			PH	33	Y	Y	B-F	S1

* Blade for "Flip" Key plastic head

See info on the uses of the keys on Silca Electronic Keys Catalogue

















1	2	2a	3	3a	3b	E1+E2		6	42+71	72	43 44a	12	15	
CAR MAKE/MODEL		FROM 1995	TO 2014	SILCA REF.  Ref.	SILCA REF.  "TE" Silca Ref.	 SILCA REF.  "Flip Keys" Silca Ref.	COPY	GEN.	TRANSP. TYPE 	ID  FAST COPY PLUS RW4 PLUS FAST COPY/RW4	COPY  FAST COPY PLUS RW4 PLUS	COPY  FAST COPY RW4	STP 	
LAND ROVER®														
DEFENDER	1995	2003	NE75EP		NE75FH*									
DISCOVERY	1995	2004	NE75EP		NE75FH*									
FREELANDER	2003	2006	NE75MH		NE75FH*	Y		PH/CR2	46	Y		P-BOX		
LDV®														
CONVOY	1998	2000	FO19MH		FO19FH*	Y	Y	TEXAS	4C	Y		P-BOX		
CUB	1998	2000	FO19MH		FO19FH*	Y	Y	TEXAS	4C	Y		P-BOX		
MARUTI SUZUKI®														
800	2007	2010	SZ18MH		SZ18FH*	Y	Y	TEX/CR	65	Y		P-BOX		
ESTEEM	2007		SZ18RMH		SZ18RFH*	Y	Y	TEX/CR	65	Y		P-BOX		
OMNI	2007	2010	SZ18RMH		SZ18RFH*	Y	Y	TEX/CR	65	Y		P-BOX		
MERCEDES®														
VITO	1996		YM15P		YM15FH*									
VITO	1998		YM15T5		YM15FH*			MEG	13	Y		Y	M-V	
VITO	1999		YM15T5		YM15FH*			TEMIC	12	Y		Y		
MITSUBISHI®														
RAIDER	2006	2010	CY24MH	CY24TE	CY24FH*	Y	Y	PH/CR2	46	Y		P-BOX		
OPEL-VAUXHALL®														
ASTRA	1995	1998	HU46T2		HU46FH*			PH	33	Y		Y	S-O	
ASTRA	1995	1998	YM28T2		YM28FH*			PH	33	Y		Y	S-O	
ASTRA	1998	2001	HU46T9		HU46FH*			PH/CR	40					
ASTRA	1998	2000	HU46T2		HU46FH*			PH/CR	40	RD		RD		
ASTRA	1998	2000	YM28T2		YM28FH*			PH/CR	40	RD		RD		
ASTRA	2001	2004	HU46T12		HU46FH*			PH/CR	40					
COMBO	1998	2002	HU46T2		HU46FH*			PH	33	Y		Y	S-O	
COMBO	2002		HU46T12		HU46FH*			PH/CR	40					
CORSA	1995	1998	HU46T2		HU46FH*			PH	33	Y		Y	S-O	
CORSA	1995	1998	YM28T2		YM28FH*			PH	33	Y		Y	S-O	
CORSA	1998	1999	HU46T9		HU46FH*			PH/CR	40					
CORSA	1998	2000	HU46T2		HU46FH*			PH/CR	40	RD		RD		
CORSA	2000	2004	HU46T12		HU46FH*			PH/CR	40					
OMEGA	1998	2001	HU46T9		HU46FH*			PH/CR	40					
OMEGA	1998	1999	HU46T2		HU46FH*			PH/CR	40	RD		RD		
OMEGA	1998	1999	YM28T2		YM28FH*			PH/CR	40	RD		RD		
SPEEDSTER	2001	2005	HU46T12		HU46FH*			PH/CR	40					
TIGRA	1995	1998	HU46T2		HU46FH*			PH	33	Y		Y	S-O	
TIGRA	1995	1998	YM28T2		YM28FH*			PH	33	Y		Y	S-O	

* Blade for "Flip" Key plastic head

See info on the uses of the keys on Silca Electronic Keys Catalogue



















1	2	2a	3	3a	3b	E1+E2		6	42+71	72	43 44a	12	15
						GTI Compatibility							
CAR MAKE/MODEL 	FROM 1995	TO 2014	SILCA REF.  Ref.	SILCA REF.  "TE" Silca Ref.	 SILCA REF.  "Flip Keys" Silca Ref.	COPY 	GEN. 	TRANSP. TYPE 	ID  FAST COPY PLUS RW4 PLUS FAST COPY/RW4	COPY  FAST COPY PLUS RW4 PLUS	COPY  FAST COPY RW4	STP  	
OPEL-VAUXHALL®													
TIGRA	1998	2001	HU46T9		HU46FH*			PH/CR	40				
TIGRA	1998	2000	HU46T2		HU46FH*			PH/CR	40	RD	RD		
TIGRA	2001	2002	HU46T12		HU46FH*			PH/CR	40				
VECTRA	2001	2004	HU46T12		HU46FH*			PH/CR	40				
ZAFIRA	2001	2005	HU46T12		HU46FH*			PH/CR	40				
PEUGEOT®													
BOXER	1996	2001	GT10BT5	GT10BTE	GT10FH*			MEG	13	Y	Y	MEG	S1
PLYMOUTH®													
BREEZE	1999	2001	CY24MH	CY24TE	CY24FH*	Y	Y	TEX/CR	64	Y	P-BOX		
NEON	2000	2001	CY24MH	CY24TE	CY24FH*	Y	Y	TEX/CR	64	Y	P-BOX		
PROWLER	2000	2002	CY24MH	CY24TE	CY24FH*	Y	Y	TEX/CR	64	Y	P-BOX		
PONTIAC®													
G8	2008	2009	GM45MH		GM45FH*	Y		PH/CR2	46	Y	P-BOX		
PROTON®													
415	1996	1998	PO1RMH		PO1RFH*	Y	Y	TEXAS	4C	Y	P-BOX		
416	1996	1998	PO1RMH		PO1RFH*	Y	Y	TEXAS	4C	Y	P-BOX		
SEAT®													
CORDOBA	1995	1998	HU49T5		HU49FH*			PH	33	Y	Y	S-V	
IBIZA	1995	1998	HU49T5		HU49FH*			PH	33	Y	Y	S-V	
INCA	1996	1998	HU49T5		HU49FH*			PH	33	Y	Y	S-V	
MARBELLA	1997	1998	HU49T5		HU49FH*			TEMIC	11	Y	Y	T-F	
TOLEDO	1995	1999	HU49T5		HU49FH*			PH	33	Y	Y	S-V	
SMART®													
FORTWO	2009		VA2MH	VA2TE	VA2FH*	Y		PH/CR2	46	Y	P-BOX		
SSANGYONG®													
ACTYON	2007		SSY3MH		SSY3FH*	Y	Y	TEX/CR	60	Y	P-BOX		
KYRON	2005		SSY3MH		SSY3FH*	Y	Y	TEX/CR	60	Y	P-BOX		
REXTON	2006		SSY3MH		SSY3FH*	Y	Y	TEX/CR	60	Y	P-BOX		
SOME MODELS			SSY3		SSY3FH*								
TATA®													
ARIA	2010		TAT1MH		TAT1FH*	Y	Y	PH/CR2	46	Y	P-BOX		
INDICA	2000		TAT1P		TAT1FH*								
INDICA	2008		TAT1MH		TAT1FH*	Y	Y	PH/CR2	46	Y	P-BOX		
INDIGO	2008		TAT1MH		TAT1FH*	Y	Y	PH/CR2	46	Y	P-BOX		
MANZA	2009		TAT1MH		TAT1FH*	Y	Y	PH/CR2	46	Y	P-BOX		

* Blade for "Flip" Key plastic head

See info on the uses of the keys on Silca Electronic Keys Catalogue



1	2	2a	3	3a	3b	E1+E2		6	42+71	72	43 44a	12	15
						GTI Compatibility							
CAR MAKE/MODEL 	FROM 1995 	TO 2014 	SILCA REF.  Ref.	SILCA REF.  "TE" Silca Ref.	 SILCA REF.  "Flip Keys" Silca Ref.	COPY 	GEN. 	TRANSP. TYPE 	ID  FAST COPY PLUS RW4 PLUS FAST COPY/RW4	COPY  FAST COPY PLUS RW4 PLUS	COPY  FAST COPY RW4	STP   	
TOYOTA®													
COROLLA	1996	1999	TOY46RMH	TOY46RTE	TOY46RFH*	Y	Y	TEXAS	4C	Y	P-BOX		
VOLKSWAGEN®													
CADDY	1995	1998	HU49T5		HU49FH*			PH	33	Y	Y	S-V	
CADDY	1998	2000	HU49T10		HU49FH*			PH/CR	42	Y	Y		
CADDY	2000	2003	HU49T28		HU49FH*			PH/CR	4W	RD	RD		
GOLF CABRIO	1995	1998	HU49T5		HU49FH*			PH	33	Y	Y	S-V	
GOLF	1995	1998	HU49T5		HU49FH*			PH	33	Y	Y	S-V	
LT 28	2000	2006	YM15T5		YM15FH*			TEMIC	12	Y	Y		
PASSAT	1995	1997	HU49T5		HU49FH*			PH	33	Y	Y	S-V	
POLO	1995	1998	HU49T5		HU49FH*			PH	33	Y	Y	S-V	
TRANSPORTER	1995	1998	HU49T5		HU49FH*			PH	33	Y	Y	S-V	
TRANSPORTER	1998	2001	HU49T28		HU49FH*			PH/CR	4W	RD	RD		
TRANSPORTER	1998	2001	HU49T10		HU49FH*			PH/CR	42	Y	Y		
TRANSPORTER	1998	2001	HU49T10X		HU49FH*			PH/CR	42	Y	Y		
VENTO	1995	1998	HU49T5		HU49FH*			PH	33	Y	Y	S-V	
VOLKSWAGEN S. AMERICA®													
VARIOUS MODELS	1996		HU49EP		HU49FH*								











* Blade for "Flip" Key plastic head

See info on the uses of the keys on Silca Electronic Keys Catalogue



Truck Keys Guide / Guida Chiavi Camion / Führer für LKW Schlüssel
 Guide Clés pour Camions / Guía Llaves para Camiones / Guia Chaves para Camiões

New Updates

1	2	2a	3	3a	3b	E1+E2		6	42+71	72	43 44a	12	15
						GTI Compatibility							
TRUCK MAKE/MODEL	FROM 1995	FROM 2014	SILCA REF.  Ref.	SILCA REF.  "TE" Silca Ref.	 SILCA REF.  "Flip Keys" Silca Ref.	COPY	GEN.	TRANSP. TYPE	ID  FAST COPY PLUS RW4 PLUS FAST COPY/RW4	COPY  FAST COPY PLUS RW4 PLUS	COPY  FAST COPY RW4	STP 	
MERCEDES®													
711 (TRK)	1996		YM15P		YM15FH*								
814-817 (TRK)	1996		YM15P		YM15FH*								
917 (TRK)	1996		YM15P		YM15FH*								
1117 (TRK)	1996		YM15P		YM15FH*								
1300 (TRK)	1996		YM15P		YM15FH*								
1500 (TRK)	1996		YM15P		YM15FH*								
ACTROS (TRK)	1997		YM15T5		YM15FH*			MEG	13	Y	Y	M-V	
ACTROS (TRK)	1998		YM15T5		YM15FH*			TEMIC	12	Y	Y		
SPRINTER (TRK)	1996		YM15P		YM15FH*								
SPRINTER	1997		YM15T5		YM15FH*			TEMIC	12	Y	Y		
VARIO (TRK)	1996		YM15P		YM15FH*								
STERLING®													
BULLET	2008		CY24MH	CY24TE	CY24FH*	Y	Y	PH/CR2	46	Y	P-BOX		

* Blade for "Flip" Key plastic head

See info on the uses of the keys on Silca Electronic Keys Catalogue



Motorcycle Keys Guide / Guida Chiavi Moto / Führer für Motorräderschlüssel
 Guide Clés pour Motocyclettes / Guía Llaves para Motocicletas / Guia Chaves para Motocicletas

New Updates

1	2	2a	3	3a	3b	E1+E2		6	42+71	72	43 44a	12	15
						GTI Compatibility							
MOTORCYCLE MAKE/MODEL	FROM	TO	SILCA REF.	SILCA REF.	SILCA REF.	COPY	GEN.	TRANSP. TYPE	ID	COPY	COPY	STP	
	1995	2014											
			Ref.	"TE" Silca Ref.	"Flip Keys" Silca Ref.				FAST COPY PLUS RW4 PLUS FAST COPY/RW4	FAST COPY PLUS RW4 PLUS	FAST COPY RW4		
BMW®													
C600 SPORT	2012		BW9MH		BW9FH*	Y		PH/CR2	46	Y	P-BOX		
C650 GT	2012		BW9MH		BW9FH*	Y		PH/CR2	46	Y	P-BOX		
F650	2008	2011	BW9MH		BW9FH*	Y		PH/CR2	46	Y	P-BOX		
F800	2006		BW9MH		BW9FH*	Y		PH/CR2	46	Y	P-BOX		
G650	2011		BW9MH		BW9FH*	Y		PH/CR2	46	Y	P-BOX		
K1200	2005	2008	BW9MH		BW9FH*	Y		PH/CR2	46	Y	P-BOX		
K1300	2009		BW9MH		BW9FH*	Y		PH/CR2	46	Y	P-BOX		
K1600	2011		BW9MH		BW9FH*	Y		PH/CR2	46	Y	P-BOX		
R1200	2005		BW9MH		BW9FH*	Y		PH/CR2	46	Y	P-BOX		
CAGIVA®													
900 ELEFANT	1997	1997	KW14P		KW14FH*								
MITO	1994		KW14		KW14FH*								
MITO	1994		KW14P		KW14FH*								
MITO EV	1994		KW14		KW14FH*								
MITO EV	1994		KW14P		KW14FH*								
MITO RACING	1994		KW14		KW14FH*								
MITO RACING	1994		KW14P		KW14FH*								
DUCATI®													
748	1995	2003	KW14		KW14FH*								
748	1995	2003	KW14P		KW14FH*								
996	1999	2001	KW14		KW14FH*								
996	1999	2001	KW14P		KW14FH*								
998	2002	2004	KW14P		KW14FH*								
MONSTER 600	1994	2001	KW14		KW14FH*								
MONSTER 600	1994	2001	KW14P		KW14FH*								
MONSTER 900	1994	2001	KW14P		KW14FH*								
ST2	1997	2003	KW14		KW14FH*								
ST2	1997	2003	KW14P		KW14FH*								
ST4	1998	2003	KW14		KW14FH*								
ST4	1998	2003	KW14P		KW14FH*								
SUPERSPORT 750	1999	2003	KW14		KW14FH*								
SUPERSPORT 750	1999	2003	KW14P		KW14FH*								
SUPERSPORT 900	1998	2002	KW14		KW14FH*								
SUPERSPORT 900	1998	2002	KW14P		KW14FH*								
KAWASAKI®													
BN125 ELIMINATOR	2006	2007	KW14AP		KW14FH*								

* Blade for "Flip" Key plastic head

See info on the uses of the keys on Silca Electronic Keys Catalogue



Motorcycle Keys Guide / Guida Chiavi Moto / Führer für Motorräderschlüssel
 Guide Clés pour Motocyclettes / Guía Llaves para Motocicletas / Guia Chaves para Motocicletas

New Updates

1	2	2a	3	3a	3b	E1+E2		6	42+71	72	43 44a	12	15
						GTI Compatibility							
MOTORCYCLE MAKE/MODEL	FROM	TO	SILCA REF.	SILCA REF.	SILCA REF.	COPY	GEN.	TRANSP. TYPE	ID	COPY	COPY	STP	
	1995	2014											
			Ref.	"TE" Silca Ref.	"Flip Keys" Silca Ref.				FAST COPY PLUS RW4 PLUS FAST COPY/RW4	FAST COPY PLUS RW4 PLUS	FAST COPY RW4		
EN500	2000	2009	KW14AP		KW14FH*								
NINJA 1000	2011		KW14MH		KW14FH*	Y	Y	TEX/CR	72	Y	P-BOX		
NINJA 650	2012		KW14MH		KW14FH*	Y	Y	TEX/CR	72	Y	P-BOX		
NINJA ZX-10R	2011		KW14MH		KW14FH*	Y	Y	TEX/CR	72	Y	P-BOX		
NINJA ZX-14R	2012		KW14MH		KW14FH*	Y	Y	TEX/CR	72	Y	P-BOX		
VN1500	2002	2003	KW14AP		KW14FH*								
VN1600	2003	2008	KW14AP		KW14FH*								
VN1700	2009		KW14AP		KW14FH*								
VN2000	2004	2010	KW14AP		KW14FH*								
Z1000	2010		KW14MH		KW14FH*	Y	Y	TEX/CR	72	Y	P-BOX		
ZZR1400	2012		KW14MH		KW14FH*	Y	Y	TEX/CR	72	Y	P-BOX		

REMINDER: new items of the Silca Vehicle Guide Legend

<p>"TE" Silca Ref.</p>	<p>Silca TE Key reference Referenza Chiave Silca TE Silca TE Schlüssel-Referenz Référence Clé Silca TE Referencia Llave Silca Referência Chave Silca TE</p>	<p>"Flip Keys" Silca Ref.</p>	<p>Silca Flip Key reference Referenza Chiave Flip Silca Silca Klappschlüssel-Referenz Référence Clé Flip Silca Referencia Llave Plegable Silca Referência Chave Flip Silca</p>
-------------------------------	---	--------------------------------------	--

For more info on the uses of car keys, refer to the Silca Electronic Keys Catalogue.

For more info on the uses of truck keys, refer to the Silca Electronic Keys Catalogue.

For more info on the uses of motorcycle keys, refer to the Silca Electronic Keys Catalogue.

IMPORTANT NOTE

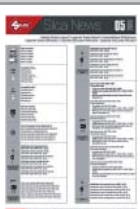

See also "Vehicle Guide Legend"
 Vedi anche "Legenda Guida Veicoli"
 Siehe auch "Autoschlüssel Erläuterung"
 Voir aussi "Légende Guide Véhicules"
 Véase también "Leyenda Guía para Vehículos"
 Veja também "Legenda Guia para Veículos"



MATRIX ONE

MATRIX ONE

User-friendly / Precise / Versatile

Matrix One is Silca's latest key cutting machine for laser and flat dimple cut keys and represents a winning combination of precise and smooth movements, ergonomic and comfortable working area, guaranteeing great performances thanks to the electromechanical gauging system.

MATRIX ONE

Intuitiva / Precisa / Versatile

Matrix One è la nuova macchina duplicatrice Silca per chiavi punzonate a cifratura piana e chiavi laser e rappresenta una combinazione vincente di movimenti precisi e fluidi, area di lavoro ergonomica e confortevole e garantisce prestazioni di ottima qualità grazie ad un sistema di calibrazione elettromeccanico.

MATRIX ONE

Intuitiv / Präzise / Vielseitig

Matrix One ist die neue Schlüsselkopiermaschine von Silca für Bohrmuldenschlüssel mit senkrechter Fräsung und Bahnschlüssel und bietet eine unschlagbare Kombination aus präzisen und flüssigen Bewegungen, Ergonomie und Komfort in der Bedienung und Ergebnisse von höchster Qualität dank ihres elektromechanischen Kalibrierungssystems.

MATRIX ONE

Intuitiva / Precisa / Versátil

Matrix One es la nueva máquina duplicadora Silca para llaves punzonadas con cifrado plano y llaves láser y presenta una combinación ganadora de movimientos exactos y fluidos y un área de trabajo ergonómica y confortable, garantizando prestaciones de óptima calidad gracias a un sistema de calibrado electromecánico.



Machine Code: D843298ZB

MATRIX ONE

Intuitive / Précise / Versatile

Matrix One est la nouvelle machine à tailler les clés de Silca pour clés à points à taillage plat et clés laser et est une combinaison gagnante de mouvements précis et fluides avec son espace de travail ergonomique et confortable. Elle garantit des performances haut de gamme grâce à son système d'étalonnage électromécanique.

MATRIX ONE

Intuitiva / Precisa / Versátil

Matrix One é a nova máquina duplicadora Silca para chaves de pontos de corte plano e chaves laser e representa uma combinação excelente de movimentos precisos e fluidos, área de trabalho ergonómica e confortável e garante performances de óptima qualidade graças a um sistema de calibragem electromecânico.



Electromechanical calibration of the machine



Micrometric gauge

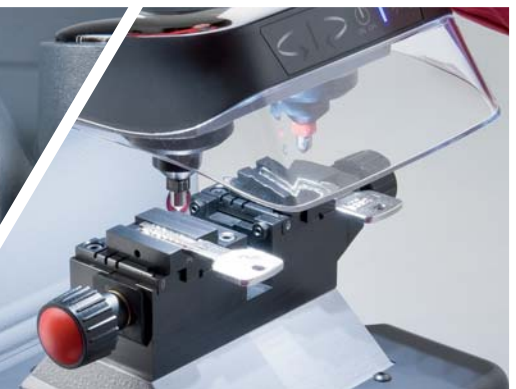

Led-lighting of the working area

Be the One with Matrix!

FOR:
PER: **KESO (CH)**

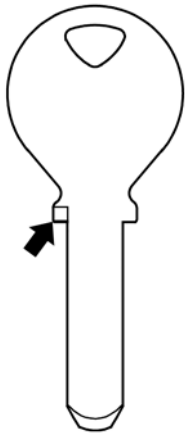

4000S

System protected by a password issued by Silca on receipt of authorization.

Sistema protetto da password rilasciata da Silca a fronte di autorizzazione.

System geschützt durch von Silca geliefertes Password auf Genehmigung.

Système protégé par un password qui est émis par Silca sur autorisation.

Sistema protegido por password que expide Silca contra autorización.

Sistema protegido por uma password emitida por Silca contra a autorização.



TRIAX QUATTRO
TRIAX-E.CODE



QUATTROCODE

OPTIONAL



D743220ZB

Adaptors for KESO keys
Adattatori per chiavi KESO
Adapters für KESO Schlüssel
Adaptateurs pour clés KESO
Adaptadores para llaves KESO
Adaptadores para chaves KESO

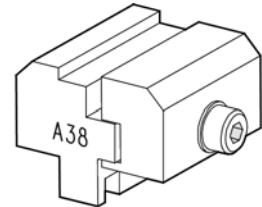

OPTIONAL

D736166ZB

Tracer point U112
Tastatore U112
Taster U112
Palpeur U112
Palpador U112
Palpador U112



ATTENTION! this information replaces the previous one published on page 29 of the SILCA NEWS nr.11-2013.

ATTENZIONE! questa informazione sostituisce quanto pubblicato a pag.29 del SILCA NEWS nr.11-2013.

ACHTUNG! Diese Information ersetzt die vorhergehende auf Seite 29 der SILCA NEWS nr.11 2013 veröffentlicht.

ATTENTION! cette information remplace la précédente publiée à la page 29 du Silca NEWS nr. 11-2013.

¡ATENCIÓN! esta información sustituye a la publicada anteriormente en la página 29 del SILCA NEWS nr.11-2013.

ATENÇÃO! esta informação substitui a anterior publicada na página 29 do Silca NEWS n.º 11-2013.

OPTIONAL



D738801ZB

Cutter W155 (carbide)
Fresa W155 (metallo duro)
Fräser W155 (Hartmetall)
Fraise W155 (au carbure)
Fresa W155 (metal duro)
Fresa W155 (metal duro)

OPTIONAL



D743220ZB

Adaptors for KESO keys
Adattatori per chiavi KESO
Adapters für KESO Schlüssel
Adaptateurs pour clés KESO
Adaptadores para llaves KESO
Adaptadores para chaves KESO

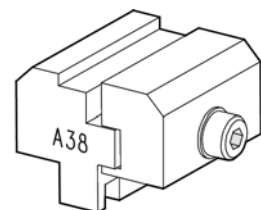

STANDARD

D908994ZR

Tracer point U102
Tastatore U102
Taster U102
Palpeur U102
Palpador U102
Palpador U102



OPTIONAL



D738801ZB













Cutter W155 (carbide)
Fresa W155 (metallo duro)
Fräser W155 (Hartmetall)
Fraise W155 (au carbure)
Fresa W155 (metal duro)
Fresa W155 (metal duro)

New keys / Chiavi Nuove / Neue Schlüssel / Nouvelles Clés
Llaves Nuevas / Chaves Nuevas

FOR: PER:	SFB	HONDA	HUF	KAWASAKI	FOR / PER
	<p>04</p> <p>11</p> <p>5</p> <p>SFB1R</p>	<p>97</p> <p>P460</p> <p>6+6</p> <p>S582 S619</p> <p>HON66TE</p> <p>... (SUB) K001-N718 ... (MAIN) K001-N718</p> <p>Key with Adapter / without Transponder Chiave con Adattatore / senza Transponder Schlüssel mit Adapter / ohne Transponder Clé avec Adaptateur / sans Transpondeur Llaves con Adaptador / sin Transponder Chave com Adaptador / sem Transponder</p>	<p>97</p> <p>P465</p> <p>8+8</p> <p>S36 S351</p> <p>HU56RTE</p> <p>DH ... 0001-4000 DH ... 6001-8000</p> <p>Key with Adapter / without Transponder Chiave con Adattatore / senza Transponder Schlüssel mit Adapter / ohne Transponder Clé avec Adaptateur / sans Transpondeur Llaves con Adaptador / sin Transponder Chave com Adaptador / sem Transponder</p>	<p>96</p> <p>P466</p> <p>6</p> <p>151</p> <p>KW16TE</p> <p>Z ... 5001-6000</p> <p>Key with Adapter / without Transponder Chiave con Adattatore / senza Transponder Schlüssel mit Adapter / ohne Transponder Clé avec Adaptateur / sans Transpondeur Llaves con Adaptador / sin Transponder Chave com Adaptador / sem Transponder</p>	HONDA (J) HUF (D) KAWASAKI (J) MAZDA (J) SFP (S) SUZUKI (J) TRW SIPEA (I)
	<p>96</p> <p>P463</p> <p>10</p> <p>288</p> <p>MAZ24RTE</p> <p>... 10100-12283</p> <p>Key with Adapter / without Transponder Chiave con Adattatore / senza Transponder Schlüssel mit Adapter / ohne Transponder Clé avec Adaptateur / sans Transpondeur Llaves con Adaptador / sin Transponder Chave com Adaptador / sem Transponder</p>	<p>96</p> <p>P464</p> <p>7</p> <p>289</p> <p>SZ17RTE</p> <p>A ... 301-500 A ... 6001-7000</p> <p>Key with Adapter / without Transponder Chiave con Adattatore / senza Transponder Schlüssel mit Adapter / ohne Transponder Clé avec Adaptateur / sans Transpondeur Llaves con Adaptador / sin Transponder Chave com Adaptador / sem Transponder</p>	<p>96</p> <p>P456</p> <p>9</p> <p>258</p> <p>GT15RBTE</p> <p>W ... 1-9640</p> <p>Key with Adapter / without Transponder Chiave con Adattatore / senza Transponder Schlüssel mit Adapter / ohne Transponder Clé avec Adaptateur / sans Transpondeur Llaves con Adaptador / sin Transponder Chave com Adaptador / sem Transponder</p>	Blue head Testa blu Blauer Kopf Tête bleue Cabeza azul Cabeça azul	

01
COMMERCIAL GROUP
GRUPPO COMMERCIALE
PREISEGRUPPE
GROUPE COMMERCIAL
GRUPO COMMERCIAL
GRUPO COMERCIAL











www.silca.biz

1	2	2a	3	3a	3b	E1+E2		6	42+71	72	43 44a	12	15	
						GTI Compatibility								
CAR MAKE/MODEL 	FROM 1995	TO 2014	SILCA REF.  Ref.	SILCA REF.  "TE" Silca Ref.	SILCA REF.  "Flip Keys" Silca Ref.	COPY 	GEN. 	TRANSP. TYPE 	ID  FAST COPY PLUS RW4 PLUS FAST COPY/RW4	COPY  FAST COPY PLUS RW4 PLUS	COPY  FAST COPY RW4	STP  		
ACURA®														
CSX	2006	2011	HON66MH	HON66TE	HON66FH*	Y	Y	PH / CR2	46	Y	P-BOX			
MDX	2007	2013	HON66MH	HON66TE	HON66FH*	Y	Y	PH / CR2	46	Y	P-BOX			
RDX	2007	2012	HON66MH	HON66TE	HON66FH*	Y	Y	PH / CR2	46	Y	P-BOX			
TL	2007		HON66MH	HON66TE	HON66FH*	Y	Y	PH / CR2	46	Y	P-BOX			
TSX	2007		HON66MH	HON66TE	HON66FH*	Y	Y	PH / CR2	46	Y	P-BOX			
ZDX	2010	2012	HON66MH	HON66TE	HON66FH*	Y	Y	PH / CR2	46	Y	P-BOX			
BMW®														
SERIE 1	2004	2011	HU92RTEK			Y		PH / CR2	46	Y	P-BOX			
SERIE 3	2005	2011	HU92RTEK			Y		PH / CR2	46	Y	P-BOX			
SERIE 5	2003	2010	HU92RTEK			Y		PH / CR2	46	Y	P-BOX			
SERIE 6	2004	2011	HU92RTEK			Y		PH / CR2	46	Y	P-BOX			
X1	2009	2011	HU92RTEK			Y		PH / CR2	46	Y	P-BOX			
X5	2004	2011	HU92RTEK			Y		PH / CR2	46	Y	P-BOX			
X6	2008	2012	HU92RTEK			Y		PH / CR2	46	Y	P-BOX			
Z4	2006	2011	HU92RTEK			Y		PH / CR2	46	Y	P-BOX			
BUICK®														
ENCORE	2014							PH / CR2	46					
ENCORE	2014		HU100MH	HU100TE	HU100FH*	Y		PH / CR2	46	Y	P-BOX			
DODGE®														
DART	2013		SMART KEY					PH / CR2	46					
DURANGO	2011	2013						PH / CR2	46					
DURANGO	2011	2013	EK3P-Y170					PH / CR2	46	Y	P-BOX			
DURANGO	2014		SMART KEY					PH / CR2	46					
RAM	2013		SMART KEY					PH / CR2	46					
FIAT®														
BRAVA	1995	1996	GT15RBT5	GT15RBTE	GT15RFH*			MEG	13	Y	Y	MEG	S1	
BRAVO	1995	1996	GT15RBT5	GT15RBTE	GT15RFH*			MEG	13	Y	Y	MEG	S1	
CINQUECENTO	1997	1998	GT15RBT5	GT15RBTE	GT15RFH*			MEG	13	Y	Y	MEG	S1	
CROMA	2005	2010	SIP22TEK			Y		PH / CR2	46	Y	P-BOX			
MARENGO	1996	2001	GT15RBT5	GT15RBTE	GT15RFH*			MEG	13	Y	Y	MEG	S1	
SEICENTO	1997	2000	GT15RBT5	GT15RBTE	GT15RFH*			MEG	13	Y	Y	MEG	S1	
TEMPRA	1995	1996	GT15RBT5	GT15RBTE	GT15RFH*			MEG	13	Y	Y	MEG	S1	
FORD USA®														
ESCAPE	2013		HU101T17					TEX / CR	63					
FIESTA	2011		SMART KEY					TEX / MA	6E					

* Blade for "Flip" Key plastic head

See info on the uses of the keys on Silca Electronic Keys Catalogue















1	2	2a	3	3a	3b	E1+E2		6	42+71	72	43 44a	12	15
CAR MAKE/MODEL 	FROM	TO	SILCA REF.  Ref.	SILCA REF.  "TE" Silca Ref.	SILCA REF.  "Flip Keys" Silca Ref.	COPY	GEN.	TRANSP. TYPE 	ID  FAST COPY PLUS RW4 PLUS FAST COPY/RW4	COPY  FAST COPY PLUS RW4 PLUS	COPY  FAST COPY RW4	STP 	
	FORD USA®												
FOCUS	2014		SMART KEY					TEX / MA	6E				
FUSION	2011	2012						TEX / MA	6E				
FUSION	2013		SMART KEY					TEX / MA	6E				
FUSION	2013							TEX / MA	6E				
TAURUS	2010		SMART KEY					TEX / CR	63				
TAURUS	2011							TEX / MA	6E				
TRANSIT	2013		HU101T20					TEX / MA	6E				
TRANSIT CONNECT	2014		HU101T20					TEX / MA	6E				
GMC (GM)®													
SIERRA	2007	2013	B111-PT					PH / CR2	46				A
SIERRA	2014							PH / CR2	46				
SIERRA	2014		HU100MH	HU100TE	HU100FH*	Y		PH / CR2	46	Y	P-BOX		
HONDA®													
ACCORD	2003	2006	HON66MH	HON66TE	HON66FH*	Y	Y	PH / CR2	46	Y	P-BOX		
ACCORD	2008		HON66MH	HON66TE	HON66FH*	Y	Y	PH / CR2	46	Y	P-BOX		
CIVIC	2006		HON66MH	HON66TE	HON66FH*	Y	Y	PH / CR2	46	Y	P-BOX		
CIVIC (AUSTRALIA)	2003		HON66MH	HON66TE	HON66FH*	Y	Y	PH / CR2	46	Y	P-BOX		
CR-V	2007		HON66MH	HON66TE	HON66FH*	Y	Y	PH / CR2	46	Y	P-BOX		
CR-Z	2010		HON66MH	HON66TE	HON66FH*	Y	Y	PH / CR2	46	Y	P-BOX		
INSIGHT	2009		HON66MH	HON66TE	HON66FH*	Y	Y	PH / CR2	46	Y	P-BOX		
JAZZ	2009		HON66MH	HON66TE	HON66FH*	Y	Y	PH / CR2	46	Y	P-BOX		
MDX (AUSTRALIA)	2003		HON66MH	HON66TE	HON66FH*	Y	Y	PH / CR2	46	Y	P-BOX		
STREAM	2008		HON66MH	HON66TE	HON66FH*	Y	Y	PH / CR2	46	Y	P-BOX		
HONDA USA®													
ACCORD	2003		HON66MH	HON66TE	HON66FH*	Y	Y	PH / CR2	46	Y	P-BOX		
ACCORD CROSST	2010		HON66MH	HON66TE	HON66FH*	Y	Y	PH / CR2	46	Y	P-BOX		
CIVIC	2006		HON66MH	HON66TE	HON66FH*	Y	Y	PH / CR2	46	Y	P-BOX		
CR-V	2007		HON66MH	HON66TE	HON66FH*	Y	Y	PH / CR2	46	Y	P-BOX		
CR-Z	2011		HON66MH	HON66TE	HON66FH*	Y	Y	PH / CR2	46	Y	P-BOX		
ELEMENT	2006	2011	HON66MH	HON66TE	HON66FH*	Y	Y	PH / CR2	46	Y	P-BOX		
FIT	2009		HON66MH	HON66TE	HON66FH*	Y	Y	PH / CR2	46	Y	P-BOX		
INSIGHT	2010		HON66MH	HON66TE	HON66FH*	Y	Y	PH / CR2	46	Y	P-BOX		
ODYSSEY	2005		HON66MH	HON66TE	HON66FH*	Y	Y	PH / CR2	46	Y	P-BOX		
PILOT	2006		HON66MH	HON66TE	HON66FH*	Y	Y	PH / CR2	46	Y	P-BOX		
RIDGELINE	2005		HON66MH	HON66TE	HON66FH*	Y	Y	PH / CR2	46	Y	P-BOX		

* Blade for "Flip" Key plastic head

See info on the uses of the keys on Silca Electronic Keys Catalogue















1	2	2a	3	3a	3b	E1+E2		6	42+71	72	43 44a	12	15	
						GTI Compatibility								
CAR MAKE/MODEL 	FROM 1995	TO 2014	SILCA REF.  Ref.	SILCA REF.  "TE" Silca Ref.	SILCA REF.  "Flip Keys" Silca Ref.	COPY 	GEN. 	TRANSP. TYPE 	ID  FAST COPY PLUS RW4 PLUS FAST COPY/RW4	COPY  FAST COPY PLUS RW4 PLUS	COPY  FAST COPY RW4	STP  		
HYUNDAI®														
GENESIS	2009		SMART KEY					PH / CR2	46					
VERACRUZ	2007	2012	HYN14RMH	HYN14RTE	HYN14RFH*	Y	Y	PH / CR2	46	Y	P-BOX			
VERACRUZ	2007	2012	HYN14RT14					PH / CR2	46					
VERACRUZ	2011	2012	SMART KEY					PH / CR2	46					
INFINITI®														
FX35	2003	2013	SMART KEY					PH / CR2	46					
FX45	2003	2013	SMART KEY					PH / CR2	46					
FX50	2009	2013	SMART KEY					PH / CR2	46					
JX35	2012	2013	SMART KEY					PH / CR2	46					
M37	2011	2013	SMART KEY					PH / CR2	46					
M56	2011	2013	SMART KEY					PH / CR2	46					
Q50	2014		SMART KEY					PH / CR2	46					
Q60	2013		SMART KEY					PH / CR2	46					
Q70	2013		SMART KEY					PH / CR2	46					
QX60	2013		SMART KEY					PH / CR2	46					
QX70	2013		SMART KEY					PH / CR2	46					
QX80	2013		SMART KEY					PH / CR2	46					
JEEP®														
G. CHEROKEE	2014		SMART KEY					PH / CR2	46					
KIA®														
BORREGO	2009	2011	SMART KEY					PH / CR2	46					
CADENZA	2014		SMART KEY					PH / CR2	46					
OPTIMA (USA)	2010		SMART KEY					PH / CR2	46					
RIO (USA)	2011		SMART KEY					PH / CR2	46					
SOUL (USA)	2011	2013	SMART KEY					PH / CR2	46					
SPORTAGE (USA)	2011	2013	SMART KEY					PH / CR2	46					
MAZDA®														
CX-7	2007		MAZ24RMH	MAZ24RTE	MAZ24RFH*	Y	Y	TEX / CR	63	Y	P-BOX			
CX-9	2007		MAZ24RMH	MAZ24RTE	MAZ24RFH*	Y	Y	TEX / CR	63	Y	P-BOX			
DEMIO [J]	2003		MAZ24RMH	MAZ24RTE	MAZ24RFH*	Y	Y	TEX / CR	63	Y	P-BOX			
MAZDA 2	2003		MAZ24RMH	MAZ24RTE	MAZ24RFH*	Y	Y	TEX / CR	63	Y	P-BOX			
MAZDA 3	2004	2013	MAZ24RMH	MAZ24RTE	MAZ24RFH*	Y	Y	TEX / CR	63	Y	P-BOX			
MAZDA 3	2004	2013	MAZ24RT17					TEX / CR	63					
MAZDA 3	2010	2013	SMART KEY					TEX / CR	63					
MAZDA 5	2005		MAZ24RMH	MAZ24RTE	MAZ24RFH*	Y	Y	TEX / CR	63	Y	P-BOX			

* Blade for "Flip" Key plastic head

See info on the uses of the keys on Silca Electronic Keys Catalogue



1	2	2a	3	3a	3b	E1+E2		6	42+71	72	43 44a	12	15	
						GTI Compatibility								
CAR MAKE/MODEL 	FROM 1995	TO 2014	SILCA REF.  Ref.	SILCA REF.  "TE" Silca Ref.	SILCA REF.  "Flip Keys" Silca Ref.	COPY 	GEN. 	TRANSP. TYPE 	ID  FAST COPY PLUS RW4 PLUS FAST COPY/RW4	COPY  FAST COPY PLUS RW4 PLUS	COPY  FAST COPY RW4	STP  		
MAZDA®														
MAZDA 6	2003	2012	MAZ24RMH	MAZ24RTE	MAZ24RFH*	Y	Y	TEX / CR	63	Y	P-BOX			
MAZDA 6	2003	2012	MAZ24RT17					TEX / CR	63					
MAZDA 6	2009	2012	SMART KEY					TEX / CR	63					
MX-5	2005		MAZ24RMH	MAZ24RTE	MAZ24RFH*	Y	Y	TEX / CR	63	Y	P-BOX			
RX-8	2004	2012	MAZ24RMH	MAZ24RTE	MAZ24RFH*	Y	Y	TEX / CR	63	Y	P-BOX			
RX-8	2004	2012	MAZ24RT17					TEX / CR	63					
RX-8	2010	2012	SMART KEY					TEX / CR	63					
RX-8	2004	2012	MAZ24RMH	MAZ24RTE	MAZ24RFH*	Y	Y	TEX / CR	63	Y	P-BOX			
RX-8	2004	2012	MAZ24RT17					TEX / CR	63					
RX-8	2010	2012	SMART KEY					TEX / CR	63					
MITSUBISHI®														
COLT	2004		HU56RMH	HU56RTE	HU56RFH*	Y	Y	PH / CR2	46	Y	P-BOX			
MIRAGE	2014							PH / CR2	46					
MIRAGE	2014		MIT11RMH	MIT11RTE	MIT11RFH*	Y	Y	PH / CR2	46	Y	P-BOX			
NISSAN USA®														
CUBE	2009	2013	NSN14MH	NSN14TE	NSN14FH*	Y	Y	PH / CR2	46	Y	P-BOX			
CUBE	2009	2013	NSN14T14					PH / CR2	46					
CUBE	2009	2013	SMART KEY					PH / CR2	46					
LEAF	2011	2013	SMART KEY					PH / CR2	46					
XTERRA	2005	2013	NSN14MH	NSN14TE	NSN14FH*	Y	Y	PH / CR2	46	Y	P-BOX			
XTERRA	2005	2013	NSN14T14					PH / CR2	46					
RENAULT-DACIA®														
DUSTER	2010	2013	VAC102MH	VAC102TE	VAC102FH*	Y	Y	PH / CR2	46	Y	P-BOX			
DUSTER	2010	2013	VAC102T32					PH / CR2	46					
LOGAN	2006	2012	VAC102MH	VAC102TE	VAC102FH*	Y	Y	PH / CR2	46	Y	P-BOX			
LOGAN	2006	2012	VAC102T32					PH / CR2	46					
SANDERO	2008	2013						PH / CR2	46					
SANDERO	2008	2013	VAC102MH	VAC102TE	VAC102FH*	Y	Y	PH / CR2	46	Y	P-BOX			
SANDERO	2010	2013	HU136MH		HU136FH*	Y		PH / CR2	46	Y	P-BOX			
SYMBOL	2010	2013	NE72MH	NE72ATE	NE72FH*	Y		PH / CR2	46	Y	P-BOX			
SMART®														
FORFOUR	2004	2006	HU56RMH	HU56RTE	HU56RFH*	Y		PH / CR2	46	Y	P-BOX			













* Blade for "Flip" Key plastic head

See info on the uses of the keys on Silca Electronic Keys Catalogue



Car Keys Guide / Guida Chiavi Auto / Führer für Autoschlüssel / Guide Clés pour Voitures
 Guía Llaves para Coches / Guia Chaves para Carros

New Updates

1	2	2a	3	3a	3b	E1+E2		6	42+71	72	43 44a	12	15
						GTI Compatibility							
CAR MAKE/MODEL	FROM	TO	SILCA REF.	SILCA REF.	SILCA REF.	COPY	GEN.	TRANSP. TYPE	ID	COPY	COPY	STP	
	1995	2014	 Ref.	 "TE" Silca Ref.	 "Flip Keys" Silca Ref.				 FAST COPY PLUS RW4 PLUS FAST COPY/RW4	 FAST COPY PLUS RW4 PLUS	 FAST COPY RW4		
SUBARU®													
BRZ	2012							TEX / MA	6E				
TOYOTA USA®													
HIGHLANDER	2010	2013						TEX / MA	6E				
RAV 4	2010	2012						TEX / MA	6E				
RAV 4	2013							TEX / MA	6E				
TUNDRA	2010							TEX / MA	6E				
VENZA	2009	2013	SMART KEY					TEX / CR	67				
VOLVO®													
S80	2008	2011	HU137TEK				Y	PH / CR2	46	Y	P-BOX		
V70	2008		HU137TEK				Y	PH / CR2	46	Y	P-BOX		
XC70	2008	2011	HU137TEK				Y	PH / CR2	46	Y	P-BOX		

* Blade for "Flip" Key plastic head

See info on the uses of the keys on Silca Electronic Keys Catalogue



Motorcycle Keys Guide / Guida Chiavi Moto / Führer für Motorräderschlüssel
Guide Clés pour Motocyclettes / Guía Llaves para Motocicletas / Guia Chaves para Motocicletas

New Updates

1	2	2a	3	3a	3b	E1+E2		6	42+71	72	43 44a	12	15
						GTI Compatibility							
MOTORCYCLE MAKE/MODEL	FROM	TO	SILCA REF.	SILCA REF.	SILCA REF.	COPY	GEN.	TRANSP. TYPE	ID	COPY	COPY	STP	
	1995	2014											
			Ref.	"TE" Silca Ref.	"Flip Keys" Silca Ref.				FAST COPY PLUS RW4 PLUS FAST COPY/RW4	FAST COPY PLUS RW4 PLUS	FAST COPY RW4		
DUCATI®													
MULTISTRADA	2010							TEX / MA	6B				
KAWASAKI®													
NINJA ZX-10R	2004	2010	KW16MH	KW16TE	KW16FH*	Y	Y	TEX / CR	72	Y	P-BOX		
NINJA ZX-12R	2002	2006	KW16MH	KW16TE	KW16FH*	Y	Y	TEX / CR	72	Y	P-BOX		
NINJA ZX-14R	2006	2011	KW16MH	KW16TE	KW16FH*	Y	Y	TEX / CR	72	Y	P-BOX		
NINJA ZX-6R	2006		KW16MH	KW16TE	KW16FH*	Y	Y	TEX / CR	72	Y	P-BOX		
Z1000	2004	2009	KW16MH	KW16TE	KW16FH*	Y	Y	TEX / CR	72	Y	P-BOX		
Z750S	2006		KW16MH	KW16TE	KW16FH*	Y	Y	TEX / CR	72	Y	P-BOX		
ZZR1200	2002	2006	KW16MH	KW16TE	KW16FH*	Y	Y	TEX / CR	72	Y	P-BOX		
ZZR1400	2007	2011	KW16MH	KW16TE	KW16FH*	Y	Y	TEX / CR	72	Y	P-BOX		
SUZUKI®													
GSF BANDIT	2007		SZ17RMH	SZ17RTE	SZ17RFH*	Y	Y	TEX / CR	71	Y	P-BOX		
GSR600	2007		SZ17RMH	SZ17RTE	SZ17RFH*	Y	Y	TEX / CR	71	Y	P-BOX		
GSX1300 HAYABUSA	2007		SZ17RMH	SZ17RTE	SZ17RFH*	Y	Y	TEX / CR	71	Y	P-BOX		
GSX-R1000	2006		SZ17RMH	SZ17RTE	SZ17RFH*	Y	Y	TEX / CR	71	Y	P-BOX		
GSX-R600	2006		SZ17RMH	SZ17RTE	SZ17RFH*	Y	Y	TEX / CR	71	Y	P-BOX		
GSX-R750	2006		SZ17RMH	SZ17RTE	SZ17RFH*	Y	Y	TEX / CR	71	Y	P-BOX		
V-STROM	2007		SZ17RMH	SZ17RTE	SZ17RFH*	Y	Y	TEX / CR	71	Y	P-BOX		

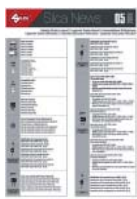

IMPORTANT NOTE:
See also "Vehicle Guide Legend"
Vedi anche "Legenda Guida Veicoli"
Siehe auch "Autoschlüssel Erläuterung"
Voir aussi "Légende Guide Véhicules"
Véase también "Leyenda Guía para Vehículos"
Veja também "Legenda Guia para Veículos"





**SILCA'S UPDATED
AUTOMOTIVE KEYS
CATALOGUE IS COMING SOON...**

STAY TUNED ON WWW.SILCA.BIZ



DUPLICATE NEW KABA CYLINDER SYSTEMS WITH SILCA

UK Be the first to offer the duplication service for the most well-known and appreciated Kaba cylinder systems.

So far, **only Silca Triax Quattro and Quattrocode key cutting machines have been appointed and certified by Kaba** and duplicate: ACE (K72)*, ACE Short (K73)*, ExperT pluS 1.0a (K83A), ExperT pluS 1.0am (K83A)*, ExperT pluS 1.0b (K83B), K20P1 (K23)* and more.

To offer this unique service to your customers, which is actually a Silca worldwide exclusive, you simply need the following (see table below):

FR Ne perdez pas l'occasion d'être le premier à offrir le service de duplication pour les systèmes cylindre Kaba les plus connus et appréciés.

Nos machines électroniques Triax Quattro et Quattrocode sont les seules jusqu'à présent sélectionnées et certifiées par Kaba et reproduisent les systèmes suivants: ACE (K72)*, ACE Short (K73)*, ExperT pluS 1.0a (K83A), ExperT pluS 1.0am (K83A)*, ExperT pluS 1.0b (K83B), K20P1 (K23)* et d'autres encore.

Pour offrir à votre clientèle ce service privilégié en exclusive mondiale pour Silca vous avez simplement besoin de (voir tableau ci-dessous):

IT Non perdere l'occasione di essere il primo ad offrire il servizio di duplicazione per i più noti ed apprezzati sistemi cilindro Kaba.

Solo le duplicatrici elettroniche Silca Triax Quattro e Quattrocode sono state ad oggi selezionate e certificate da Kaba e duplicano: ACE (K72)*, ACE Short (K73)*, ExperT pluS 1.0a (K83A), ExperT pluS 1.0am (K83A)*, ExperT pluS 1.0b (K83B), K20P1 (K23)* e non solo.

Per offrire ai tuoi clienti questo servizio privilegiato, un'esclusiva mondiale Silca, hai semplicemente bisogno di (vedi tabella sotto):

ES Sea el primero en ofrecer el servicio de duplicación para los más conocidos y apreciados sistemas cilindro Kaba.

Hasta ahora, **sólo las duplicadoras electrónicas Silca Triax Quattro y Quattrocode fueron elegidas y certificadas por Kaba** y duplican los sistemas: ACE (K72)*, ACE Short (K73)*, ExperT pluS 1.0a (K83A), ExperT pluS 1.0am (K83A)*, ExperT pluS 1.0b (K83B), K20P1 (K23)* y otros.

Para ofrecer un servicio único y exclusivo para Silca a nivel mundial a sus clientes necesitan (ver tabla abajo):

DE Seien Sie der erste, der Kopien der bekannten und geschätzten Kaba Zylindersysteme anbietet. Bislang sind **nur die Schlüsselkopiermaschinen Triax Quattro und Quattrocode von Kaba ernannt und bescheinigt worden** und kopieren: ACE (K72)*, ACE Short (K73)*, ExperT pluS 1.0a (K83A), ExperT pluS 1.0am (K83A)*, ExperT pluS 1.0b (K83B), K20P1 (K23)* und andere.

Um diesen – im Übrigen Silca weltweit exklusiven – Service anbieten zu können benötigen Sie nur folgendes (siehe Tabelle unten):

PT Seja o primeiro a oferecer serviços de duplicação de chaves para os sistemas de cilindros Kaba.

Ate o momento, **somente as máquinas Silca Triax Quattro e Quattrocode foram homologadas e certificadas por Kaba** e duplicam: ACE (K72)*, ACE Short (K73)*, ExperT pluS 1.0a (K83A), ExperT pluS 1.0am (K83A)*, ExperT pluS 1.0b (K83B), K20P1 (K23)* e ainda outros.

Para oferecer este serviço único aos seus clientes, o qual é uma exclusividade Silca a nível mundial, você simplesmente precisa do seguinte (veja a tabela abaixo):

- **Triax Quattro key cutting machine - Code: D837287ZB (230V/50Hz) - D838803ZB (120V/60Hz) - D838806ZB (100V/50-60Hz)**
- **Quattrocode key cutting machine - Code: D804788ZB (220V/50Hz) - D810170ZB (110V/60Hz) - D812351ZB (100V/50Hz)**
- **Silca Key Programs - Version 20.1.4.54 or higher - Standard Systems (see page 10)**

IMPORTANT NOTE: The systems will be available only on SKP (NO stand alone mode). Some of these systems require a password released by Kaba. Some systems on Triax Quattro require the R13 jaw and specific cutters. Triax e.code does not duplicate Kaba cylinder systems.

* These systems require a special software upgrade for Kaba Systems - Code: D742633ZB (for Triax Program) - D742632ZB (for Quattrocode Program).

NOTA IMPORTANTE: I sistemi indicati saranno disponibili solo tramite SKP (non in modalità stand alone). Alcuni di questi sistemi richiedono una password rilasciata da Kaba. Alcuni sistemi su Triax Quattro necessitano del morsetto R13 e di specifici fresini. Triax e.code non duplica i sistemi cilindro Kaba.

* Questi sistemi richiedono uno speciale aggiornamento per Sistemi Kaba: Codice: D742633ZB (per Triax Program) - D742632ZB (per Quattrocode Program).

WICHTIGER HINWEIS: Die Systeme werden nur im Silca Key Programs (SKP) verfügbar sein (nicht bei Einzelbetrieb). Für einige dieser Systeme werden Passwörter benötigt, die Kaba freigibt. Für einige Systeme, die mit Triax Quattro geschnitten werden, sind zusätzlich die Spannbacke R13 und spezielle Fräser notwendig. Mit Triax e.code können die Kaba Systeme nicht kopiert werden.

* Diese Systeme erfordern eine spezielle Software-Upgrade für Kaba Systems - Code: D742633ZB (für Triax Program) - D742632ZB (für Quattrocode Program).

NOTE IMPORTANTE: Les systèmes seront disponibles uniquement sur SKP (non en modalité stand-alone). Certains systèmes demandent un password relaché par Kaba et d'autres encore sur Triax Quattro impliquent l'utilisation de l'étau R13 et fraises particulières. Triax e.code ne copie pas les systèmes cylindre Kaba.

* Ces systèmes nécessitent une mise à jour logiciel spécial pour les Systèmes Kaba - Code: D742633ZB (Triax Program) - D742632ZB (Quattrocode Program).

NOTA IMPORTANTE: Los sistemas estarán disponibles solo en SKP (NO stand alone). Algunos de estos sistemas necesitan una password comunicada por Kaba y algunos sistemas en Triax Quattro necesitan mordazas R13 y fresas específicas. Triax e.code no duplica sistemas cilindro Kaba.

* Estos sistemas necesitan una especial actualización de software para Sistemas Kaba - Código: D742633ZB (en Triax Program) - D742632ZB (en Quattrocode Program).

NOTA IMPORTANTE: Os sistemas estarão disponíveis somente no SKP (não no modo stand alone). Alguns destes sistemas requerem um password a ser liberada por Kaba e alguns sistemas na Triax Quattro precisam do mordente R13 e fresas especiais. Triax e.code não pode duplicar as chaves para os sistemas de cilindros Kaba.

* Estes sistemas requerem uma atualização especial de software para Sistemas Kaba - Código: D742633ZB (para Triax Program) - D742632ZB (para Quattrocode Program).

DUPLICATE NEW KABA CYLINDER SYSTEMS WITH SILCA

KABA SYSTEM SISTEMA KABA KABA SYSTEM SYSTÈME KABA SISTEMA KABA	PROFILE PROFILO PROFIL PROFIL PERFIL	SERIES SERIE SERIE SERIE SERIE	KEYBLANK ARTICOLO ROHLING EBAUCHE ARTICULO	APPLICATION UTILIZZO VERARBEITER UTILISATION UTILIZACION
STANDARD SYSTEMS				
10 (K10) (10+10+18)	-	-	KA2	CYLINDER
EXPERT PLUS S 1.0A (K83A) (*)	-	-	ORIGINAL	CYLINDER
EXPERT PLUS S 1.0B (K83B) (*)	-	-	ORIGINAL	CYLINDER
EXPERT S 1.2A (K56A) (*)	-	-	ORIGINAL	CYLINDER
EXPERT S 1.2AM (K56A) (*)	-	-	ORIGINAL	CYLINDER
EXPERT S 1.2B (K56B) (*)	-	-	ORIGINAL	CYLINDER
EXPERT S 1.2BM (K56B) (*)	-	-	ORIGINAL	CYLINDER
GEMINI T 1.0 (K54)	-	-	ORIGINAL	CYLINDER
K8 RED (K8R)	-	-	KA1	CYLINDER
MATRIX (K59)	-	-	ORIGINAL	CYLINDER
MICRO (K65)	-	-	KA8	CYLINDER
MINI GREEN	-	-	KA3	CYLINDER
MINI RED	-	-	KA3	CYLINDER
TITAN-AURA-COMBI (K22-K32-K33)	-	-	ORIGINAL	CYLINDER
TITAN-AURA-COMBI (K22-K32-K33)	-	-	ORIGINAL	CYLINDER



Kaba Systems - Triax Program







KABA SYSTEM SISTEMA KABA KABA SYSTEM SYSTÈME KABA SISTEMA KABA	PROFILE PROFILO PROFIL PROFIL PERFIL	SERIES SERIE SERIE SERIE SERIE	KEYBLANK ARTICOLO ROHLING EBAUCHE ARTICULO	APPLICATION UTILIZZO VERARBEITER UTILISATION UTILIZACION
STANDARD SYSTEMS				
10 (K10) (10+10+18)	-	-	KA2	CYLINDER
EXPERT PLUS S 1.0A (K83A) (*)	-	-	ORIGINAL	CYLINDER
EXPERT PLUS S 1.0B (K83B) (*)	-	-	ORIGINAL	CYLINDER
EXPERT S 1.2A (K56A) (*)	-	-	ORIGINAL	CYLINDER
EXPERT S 1.2AM (K56A) (*)	-	-	ORIGINAL	CYLINDER
EXPERT S 1.2B (K56B) (*)	-	-	ORIGINAL	CYLINDER
EXPERT S 1.2BM (K56B) (*)	-	-	ORIGINAL	CYLINDER
GEMINI T 1.0 (K54)	-	-	ORIGINAL	CYLINDER
K8 RED (K8R)	-	-	KA1	CYLINDER
MATRIX (K59)	-	-	ORIGINAL	CYLINDER
MICRO (K65)	-	-	KA8	CYLINDER
MINI GREEN	-	-	KA3	CYLINDER
MINI RED	-	-	KA3	CYLINDER
TITAN-AURA-COMBI (K22-K32-K33)	-	-	ORIGINAL	CYLINDER
TITAN-AURA-COMBI (K22-K32-K33)	-	-	ORIGINAL	CYLINDER

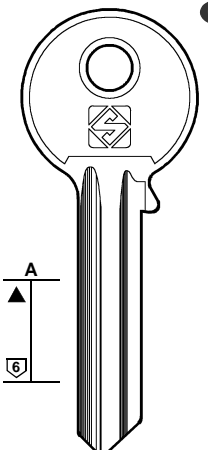
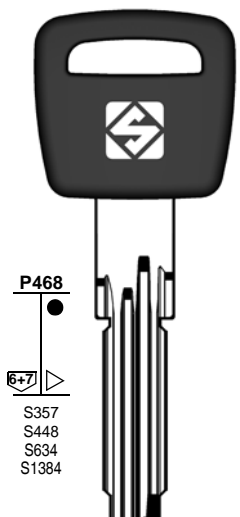

Kaba Systems - Quattrocode Program

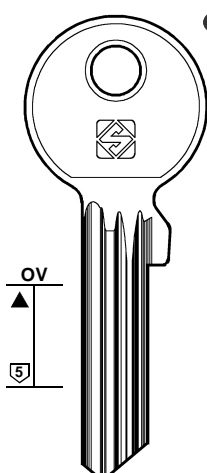
(*) The system is protected by a password and authorization must be obtained from the manufacturer. / Il sistema è protetto da password ed è necessario richiedere l'autorizzazione al costruttore. / Das System ist durch ein Passwort geschützt und es muß um die Genehmigung vom Hersteller angefragt werden. / Le système est protégé par un password et il faut demander l'autorisation au constructeur. / El sistema está protegido por una password y hace falta pedir la autorización al constructor. / O sistema é protegido por password e você deve solicitar a permissão do fabricante.

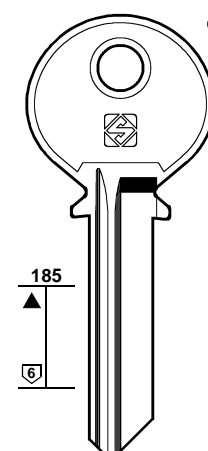
New Keys / Chiavi Nuove / Neue Schlüssel / Nouvelles Clés
Llaves Nuevas / Chaves Nuevas

FOR: PER:	3M	CISA	FOR / PER
	 <p>04</p> <p>TRM3</p>	 <p>06</p> <p>P468</p> <p>6+7</p> <p>S357 S448 S634 S1384</p> <p>CS62AP 900001-944826 (XN008710) 1-11808 (XN005710) 1-38832</p> <p>CS155AP</p> <p>CS154AP</p> <p>CS139AP</p> <p>CS116AP</p> <p>CS70AP</p> <p>CS159AP</p> <p>CS158AP</p> <p>CS157AP</p> <p>CS156AP</p> 	<p>3M (PRC)</p> <p>CISA (I)</p> <p>NEMEF (NL)</p> <p>ZEISS IKON (D)</p>
	 <p>04</p> <p>NME3</p> 	 <p>05</p> <p>ZE46</p> 	<p>01</p> <p>COMMERCIAL GROUP GRUPPO COMMERCIALE PREISEGRUPPE GROUPE COMMERCIAL GRUPO COMMERCIAL GRUPO COMERCIAL</p> <p>www.silca.biz</p>

FOR / PER

BMW (D)

CHEVROLET-DAEWOO (ROK)

HUF (D)

FOR: **BMW**

PER:

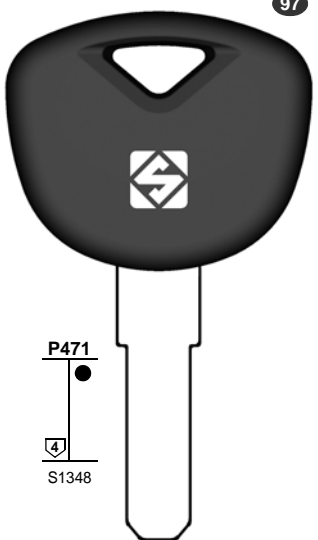

97

P471

S1348

BW9TE
K 5001-8276

Key with Adapter / without Transponder chip
Chiave con Adattatore / senza Transponder chip
Schlüssel mit Adapter / ohne Transponder chip
Clé avec Adaptateur / sans Transpondeur chip
Llaves con Adaptador / sin Transponder chip
Chave com Adaptador / sem Transponder chip

FOR: **CHEVROLET-DAEWOO**

PER:

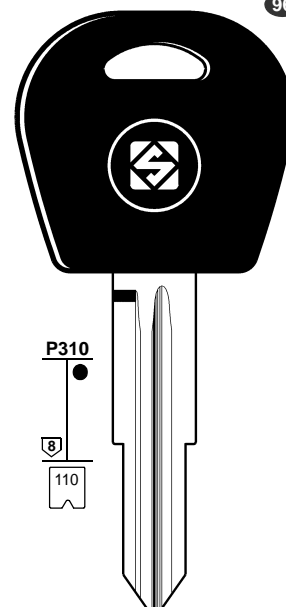

96

P310

110

DWO4RTE
J 1-1200

Key with Adapter / without Transponder chip
Chiave con Adattatore / senza Transponder chip
Schlüssel mit Adapter / ohne Transponder chip
Clé avec Adaptateur / sans Transpondeur chip
Llaves con Adaptador / sin Transponder chip
Chave com Adaptador / sem Transponder chip

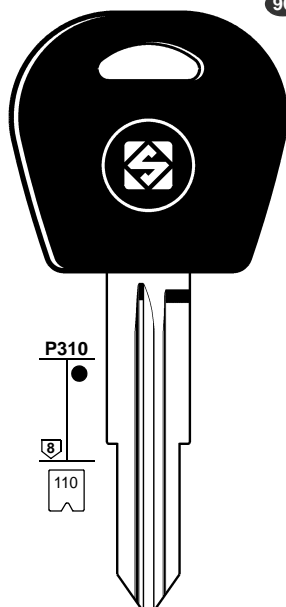

96

P310

110

DWO5TE
T 1-1200

Key with Adapter / without Transponder chip
Chiave con Adattatore / senza Transponder chip
Schlüssel mit Adapter / ohne Transponder chip
Clé avec Adaptateur / sans Transpondeur chip
Llaves con Adaptador / sin Transponder chip
Chave com Adaptador / sem Transponder chip

FOR: **HUF**

PER:

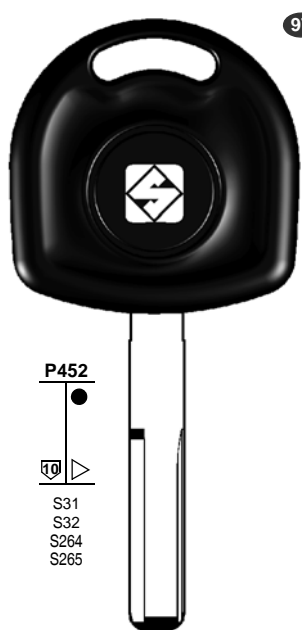

97

P452

S31
S32
S264
S265

HU43TE
H 1-3000
WH 1-3000
Y 1-3000
WY 1-3000

Key with Adapter / without Transponder chip
Chiave con Adattatore / senza Transponder chip
Schlüssel mit Adapter / ohne Transponder chip
Clé avec Adaptateur / sans Transpondeur chip
Llaves con Adaptador / sin Transponder chip
Chave com Adaptador / sem Transponder chip

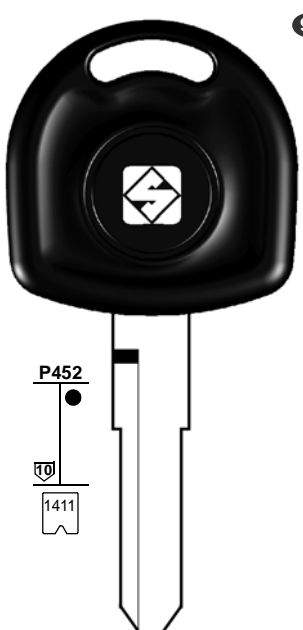

96

P452

1411

HU87RTE
.....
50001-51308

Key with Adapter / without Transponder chip
Chiave con Adattatore / senza Transponder chip
Schlüssel mit Adapter / ohne Transponder chip
Clé avec Adaptateur / sans Transpondeur chip
Llaves con Adaptador / sin Transponder chip
Chave com Adaptador / sem Transponder chip















01

COMMERCIAL GROUP
GRUPPO COMMERCIALE
PREISEGRUPPE
GROUPE COMMERCIAL
GRUPO COMMERCIAL
GRUPO COMERCIAL

www.silca.biz

Car Keys Guide / Guida Chiavi Auto / Marktführer für Autoschlüssel / Guide Clés pour Voitures
Guía Llaves para Coches / Guia Chaves para Carros

New Updates

1	2	2a	3	3a	3b	E1+E2		6	42+71	72	43 44a	12	15
						GTI COMPATIBLE							
CAR MAKE MODEL	FROM	TO	SILCA REF.	SILCA REF.	SILCA REF.	COPY	GEN.	TRANSP. TYPE	FAST COPY PLUS RW4 PLUS FAST COPY / RW4	FAST COPY PLUS RW4 PLUS	FAST COPY RW4	STP	
													

For more info on the uses of car keys, refer to the Silca Electronic Key Catalogue:



AUDI®

A4	2009		SMART KEY					PH / CR3	50				
A5	2008		SMART KEY					PH / CR3	50				
A6	2012		SMART KEY					PH / CR3	50				
A7	2011		SMART KEY					PH / CR3	50				
Q5	2009		SMART KEY					PH / CR3	50				

BMW®

SERIE 1	2011		SMART KEY					PH / CR3	47				
SERIE 2	2014		SMART KEY					PH / CR3	47				
SERIE 3	2011		SMART KEY					PH / CR3	47				
SERIE 3 GT	2013		SMART KEY					PH / CR3	47				
SERIE 4	2013		SMART KEY					PH / CR3	47				
SERIE 5	2010		SMART KEY					PH / CR3	47				
SERIE 5 GT	2010		SMART KEY					PH / CR3	47				
X6	2012		SMART KEY					PH / CR3	47				

CHEVROLET-DAEWOO®

AVEO	2006	2011	DWO4RT6	DWO4RTE	DWO4RFH*			MEG / CR	48-A				
AVEO	2006	2011		DWO4RTE	DWO4RFH*			MEG / CR	48-A	Y	Y		
CAPTIVA	2006		DWO5MH	DWO5TE	DWO5FH*	Y		PH / CR2	46	Y	P-BOX		
EPICA	2006		DWO5MH	DWO5TE	DWO5FH*	Y	Y	TEX / CR	60	Y	P-BOX		
EPICA	2008		DWO5MH	DWO5TE	DWO5FH*	Y		TEX / CR	XX	Y	P-BOX		
EVANDA	2003	2006	DWO5MH	DWO5TE	DWO5FH*	Y	Y	TEX / CR	60	Y	P-BOX		
KALOS	2002	2006		DWO4RTE	DWO4RFH*			MEG / CR	48-A	Y	Y		
LACETTI	2002	2004	DWO4RT6	DWO4RTE	DWO4RFH*			MEG / CR	48-A				
LACETTI	2002	2004		DWO4RTE	DWO4RFH*			MEG / CR	48-A	Y	Y		
LACETTI	2004	2009	DWO4RMH	DWO4RTE	DWO4RFH*	Y	Y	TEX / CR	60	Y	P-BOX		
LEGANZA	2000	2008		DWO5TE	DWO5FH*			MEG / CR	48-A	Y	Y		
NUBIRA	2000	2002	DWO4RT6	DWO4RTE	DWO4RFH*			MEG / CR	48-A				
NUBIRA	2000	2002		DWO4RTE	DWO4RFH*			MEG / CR	48-A	Y	Y		
NUBIRA SW	2004	2009	DWO4RMH	DWO4RTE	DWO4RFH*	Y	Y	TEX / CR	60	Y	P-BOX		
TACUMA	2000	2008		DWO4RTE	DWO4RFH*			MEG / CR	48-A	Y	Y		

CHEVROLET® USA











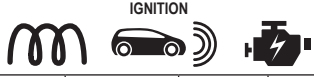





CAPTIVA SPORT	2012		DWO5MH	DWO5TE	DWO5FH*	Y		PH / CR2	46	Y	P-BOX		
---------------	------	--	--------	--------	---------	---	--	----------	----	---	-------	--	--

MAZDA®

CX-5	2012		SMART KEY					PH / CR3	47				
------	------	--	-----------	--	--	--	--	----------	----	--	--	--	--

* Blade for "Silca Flip key" plastic head

® are Registered Trademarks

















1	2	2a	3	3a	3b	E1+E2		6	42+71	72	43 44a	12	15
						GTI COMPATIBLE							
CAR MAKE MODEL	FROM	TO	SILCA REF.	SILCA REF.	SILCA REF.	COPY	GEN.	TRANSP. TYPE	FAST COPY PLUS RW4 PLUS FAST COPY / RW4	FAST COPY PLUS RW4 PLUS	FAST COPY RW4	STP	
													
For more info on the uses of car keys, refer to the Silca Electronic Key Catalogue: 													
MAZDA®													
MAZDA 3	2014		SMART KEY					PH / CR3	47				
MAZDA 6	2012		SMART KEY					PH / CR3	47				
OPEL-VAUXHALL®													
ANTARA	2007		DWO5MH	DWO5TE	DWO5FH*	Y		PH / CR2	46	Y	P-BOX		
SIGNUM	2003	2005	HU43MH	HU43TE	HU43FH*	Y		PH / CR2	46	Y	P-BOX		
VECTRA	2002	2005	HU43MH	HU43TE	HU43FH*	Y		PH / CR2	46	Y	P-BOX		
PONTIAC®													
G3	2010			DWO4RTE	DWO4RFH*			MEG / CR	48-A	Y	Y		
RENAULT®													
CLIO IV	2012		SMART KEY					PH / CR3	49				
RENAULT-DACIA®													
DUSTER	2013		ORIGINAL					PH / CR3	49				
LOGAN	2013		ORIGINAL					PH / CR3	49				
SANDERO	2013		ORIGINAL					PH / CR3	49				
SYMBOL III	2013		ORIGINAL					PH / CR3	49				
SATURN (GM)®													
VUE	2008	2010	DWO5MH	DWO5TE	DWO5FH*	Y		PH / CR2	46	Y	P-BOX		
SUBARU®													
G3X JUSTY	2004	2007	HU87RMH	HU87RTE	HU87RFH*	Y	Y	TEX / CR	65	Y	P-BOX		
SUZUKI®													
IGNIS	2000	2005	HU87RMH	HU87RTE	HU87RFH*	Y	Y	TEX / CR	65	Y	P-BOX		

* Blade for "Silca Flip key" plastic head

® are Registered Trademarks

Motorcycle Keys Guide / Guida Chiavi Moto / Marktführer für Motorräderschlüssel
 Guide Clés pour Motocyclettes / Guía Llaves para Motocicletas / Guia Chaves para Motocicletas

New Updates

1	2	2a	3	3a	3b	E1+E2		6	42+71	72	43 44a	12	15
						GTI COMPATIBLE		IGNITION 					
MOTORCYCLE MAKE MODEL	FROM	TO	SILCA REF.	SILCA REF.	SILCA REF.	COPY	GEN.	TRANSP. TYPE	FAST COPY PLUS RW4 PLUS FAST COPY / RW4	FAST COPY PLUS RW4 PLUS	FAST COPY RW4	STP	
													
For more info on the uses of motorcycle keys, refer to the Silca Electronic Key Catalogue: 													
BMW®													
C600 SPORT	2012		BW9MH	BW9TE	BW9FH*	Y		PH / CR2	46	Y	P-BOX		
C650 GT	2012		BW9MH	BW9TE	BW9FH*	Y		PH / CR2	46	Y	P-BOX		
F650	2008	2011	BW9MH	BW9TE	BW9FH*	Y		PH / CR2	46	Y	P-BOX		
F800	2006		BW9MH	BW9TE	BW9FH*	Y		PH / CR2	46	Y	P-BOX		
G650	2011		BW9MH	BW9TE	BW9FH*	Y		PH / CR2	46	Y	P-BOX		
K1200	2005	2008	BW9MH	BW9TE	BW9FH*	Y		PH / CR2	46	Y	P-BOX		
K1300	2009		BW9MH	BW9TE	BW9FH*	Y		PH / CR2	46	Y	P-BOX		
K1600	2011		BW9MH	BW9TE	BW9FH*	Y		PH / CR2	46	Y	P-BOX		
R1200	2005		BW9MH	BW9TE	BW9FH*	Y		PH / CR2	46	Y	P-BOX		



IMPORTANT NOTE:

See also the updated version of the "Vehicle Guide Legend"
 Vedi anche la versione aggiornata della "Legenda Guida Veicoli"
 Siehe auch die aktualisierte Version der "Fahrzeugschlüssel Erläuterung"
 Voir aussi la version mise à jour de la "Légende Guide Véhicules"
 Véase también la versión actualizada de la "Leyenda Guía para Vehículos"
 Veja também a versão atualizada da "Legenda Guia para Veículos"

* Blade for "Silca Flip key" plastic head

® are Registered Trademarks

SILCA EMPTY SHELLS - NEW REFERENCES

 Silca Empty Shells: **12 new keys references** to widen the existing range.



 Silca Empty Shells: **12 nouvelles références** clés qui complètent la gamme existante.

 Silca Empty Shells: **12 nuove referenze** chiavi che implementano la gamma già esistente.

 Silca Empty Shells: **12 nuevas referencias** llaves que completan la gama existente.



 Empty Shells: **12 Schlüssel Referenzen** die das bestehende Angebot zu implementieren.

 Silca Empty Shells: **12 novas referências** chaves que implementam a gama existente.

Brand	Part Number/Image	Application*/Utilization*	Models*				
			MODELS	YEAR FROM	YEAR TO	TRANSPONDER TYPE	TRP ID
CITROËN® (see also PEUGEOT®)	HU83ARS2N 	2 Buttons - Flip NO battery holder	DISPATCH	2007		PH-CR2	46
			JUMPY	2007		PH-CR2	46
CITROËN® (see also PEUGEOT®, LANCIA®)	HU83BRS8N 	3 Buttons - Flip NO battery holder	C4 PICASSO	2006		PH-CR2	46
			C5	2008		PH-CR2	46
CITROËN® (see also PEUGEOT®, LANCIA®)	HU83CRS7 	4 Buttons - Flip	C8	2006		PH-CR2	46





* The uses of the keys are purely indicative and may be subject to updates and revisions. / Gli utilizzi delle chiavi sono da considerarsi puramente indicativi e possono essere oggetto di aggiornamenti e revisioni. / Die Abbildung und technischen Daten der Schlüssel sind nicht bindend. Silca behält sich Änderungen am Produkt, die zur Verbesserung beitragen, vor. / Les usages des clés sont purement indicatifs; ils peuvent être mis à jour et revus. / Los usos de las llaves deben considerarse puramente indicativos y pueden ser objeto de actualizaciones y revisiones. / As utilizações das chaves devem ser consideradas puramente indicativas e podem ser objecto de actualizações e revisões.

© Registered Trade Marks / © Marchi Registrati / © Eingetragene Warenzeichen / © Sont des marques déposées / © Son marcas registradas / © Indicam marcas registadas

<p>CITROËN® (see also PEUGEOT®, LANCIA®)</p>	<p>HU83CRS7N</p> 	<p>4 Buttons - Flip NO battery holder</p>	<table border="1"> <thead> <tr> <th>MODELS</th> <th>YEAR FROM</th> <th>YEAR TO</th> <th>TRANSPONDER TYPE</th> <th>TRP ID</th> </tr> </thead> <tbody> <tr> <td>C8</td> <td>2006</td> <td></td> <td>PH-CR2</td> <td>46</td> </tr> </tbody> </table>	MODELS	YEAR FROM	YEAR TO	TRANSPONDER TYPE	TRP ID	C8	2006		PH-CR2	46																				
MODELS	YEAR FROM	YEAR TO	TRANSPONDER TYPE	TRP ID																													
C8	2006		PH-CR2	46																													
<p>CITROËN® (see also PEUGEOT®)</p>	<p>VA2ARS2N</p> 	<p>2 Buttons - Flip NO battery holder</p>	<table border="1"> <thead> <tr> <th>MODELS</th> <th>YEAR FROM</th> <th>YEAR TO</th> <th>TRANSPONDER TYPE</th> <th>TRP ID</th> </tr> </thead> <tbody> <tr> <td>BERLINGO</td> <td>2008</td> <td></td> <td>PH-CR2</td> <td>46</td> </tr> <tr> <td>C2</td> <td>2006</td> <td></td> <td>PH-CR2</td> <td>46</td> </tr> <tr> <td>C3</td> <td>2006</td> <td></td> <td>PH-CR2</td> <td>46</td> </tr> </tbody> </table>	MODELS	YEAR FROM	YEAR TO	TRANSPONDER TYPE	TRP ID	BERLINGO	2008		PH-CR2	46	C2	2006		PH-CR2	46	C3	2006		PH-CR2	46										
MODELS	YEAR FROM	YEAR TO	TRANSPONDER TYPE	TRP ID																													
BERLINGO	2008		PH-CR2	46																													
C2	2006		PH-CR2	46																													
C3	2006		PH-CR2	46																													
<p>CITROËN® (see also PEUGEOT®)</p>	<p>VA2BRS8N</p> 	<p>3 Buttons - Flip NO battery holder</p>	<table border="1"> <thead> <tr> <th>MODELS</th> <th>YEAR FROM</th> <th>YEAR TO</th> <th>TRANSPONDER TYPE</th> <th>TRP ID</th> </tr> </thead> <tbody> <tr> <td>C3 PICASSO</td> <td>2008</td> <td></td> <td>PH-CR2</td> <td>46</td> </tr> <tr> <td>C5</td> <td>2006</td> <td>2008</td> <td>PH-CR2</td> <td>46</td> </tr> <tr> <td>DS3</td> <td>2010</td> <td></td> <td>PH-CR2</td> <td>46</td> </tr> </tbody> </table>	MODELS	YEAR FROM	YEAR TO	TRANSPONDER TYPE	TRP ID	C3 PICASSO	2008		PH-CR2	46	C5	2006	2008	PH-CR2	46	DS3	2010		PH-CR2	46										
MODELS	YEAR FROM	YEAR TO	TRANSPONDER TYPE	TRP ID																													
C3 PICASSO	2008		PH-CR2	46																													
C5	2006	2008	PH-CR2	46																													
DS3	2010		PH-CR2	46																													
<p>FIAT® (see also LANCIA®)</p>	<p>SIP22RS8</p> 	<p>3 Buttons - Flip</p>	<table border="1"> <thead> <tr> <th>MODELS</th> <th>YEAR FROM</th> <th>YEAR TO</th> <th>TRANSPONDER TYPE</th> <th>TRP ID</th> </tr> </thead> <tbody> <tr> <td>BRAVO</td> <td>2006</td> <td>2008</td> <td>MEG-CR</td> <td>48</td> </tr> <tr> <td>DUCATO</td> <td>2002</td> <td>2005</td> <td>MEG-CR</td> <td>48</td> </tr> <tr> <td>IDEA</td> <td>2003</td> <td>2009</td> <td>MEG-CR</td> <td>48</td> </tr> <tr> <td>PUNTO</td> <td>2005</td> <td>2011</td> <td>MEG-CR</td> <td>48</td> </tr> <tr> <td>STILO</td> <td>2001</td> <td>2008</td> <td>MEG-CR</td> <td>48</td> </tr> </tbody> </table>	MODELS	YEAR FROM	YEAR TO	TRANSPONDER TYPE	TRP ID	BRAVO	2006	2008	MEG-CR	48	DUCATO	2002	2005	MEG-CR	48	IDEA	2003	2009	MEG-CR	48	PUNTO	2005	2011	MEG-CR	48	STILO	2001	2008	MEG-CR	48
MODELS	YEAR FROM	YEAR TO	TRANSPONDER TYPE	TRP ID																													
BRAVO	2006	2008	MEG-CR	48																													
DUCATO	2002	2005	MEG-CR	48																													
IDEA	2003	2009	MEG-CR	48																													
PUNTO	2005	2011	MEG-CR	48																													
STILO	2001	2008	MEG-CR	48																													





* The uses of the keys are purely indicative and may be subject to updates and revisions. / Gli utilizzi delle chiavi sono da considerarsi puramente indicativi e possono essere oggetto di aggiornamenti e revisioni. / Die Abbildung und technischen Daten der Schlüssel sind nicht bindend. Silca behält sich Änderungen am Produkt, die zur Verbesserung beitragen, vor. / Les usages des clés sont purement indicatifs; ils peuvent être mis à jour et revus. / Los usos de las llaves deben considerarse puramente indicativos y pueden ser objeto de actualizaciones y revisiones. / As utilizações das chaves devem ser consideradas puramente indicativas e podem ser objecto de actualizações e revisões.

® Registered Trade Marks / ® Marchi Registrati / ® Eingetragene Warenzeichen / ® Sont des marques déposées / ® Son marcas registradas / ® Indicam marcas registradas

<p>LANCIA® (see also CITROËN®, PEUGEOT®)</p>	<p>HU83BRS8N</p> 	<p>3 Buttons - Flip NO battery holder</p>	<table border="1"> <thead> <tr> <th>MODELS</th> <th>YEAR FROM</th> <th>YEAR TO</th> <th>TRANSPONDER TYPE</th> <th>TRP ID</th> </tr> </thead> <tbody> <tr> <td>PHEDRA</td> <td>2006</td> <td></td> <td>PH-CR2</td> <td>46</td> </tr> </tbody> </table>	MODELS	YEAR FROM	YEAR TO	TRANSPONDER TYPE	TRP ID	PHEDRA	2006		PH-CR2	46															
MODELS	YEAR FROM	YEAR TO	TRANSPONDER TYPE	TRP ID																								
PHEDRA	2006		PH-CR2	46																								
<p>LANCIA® (see also CITROËN®, PEUGEOT®)</p>	<p>HU83CRS7</p> 	<p>4 Buttons - Flip</p>	<table border="1"> <thead> <tr> <th>MODELS</th> <th>YEAR FROM</th> <th>YEAR TO</th> <th>TRANSPONDER TYPE</th> <th>TRP ID</th> </tr> </thead> <tbody> <tr> <td>PHEDRA</td> <td>2006</td> <td></td> <td>PH-CR2</td> <td>46</td> </tr> </tbody> </table>	MODELS	YEAR FROM	YEAR TO	TRANSPONDER TYPE	TRP ID	PHEDRA	2006		PH-CR2	46															
MODELS	YEAR FROM	YEAR TO	TRANSPONDER TYPE	TRP ID																								
PHEDRA	2006		PH-CR2	46																								
<p>LANCIA® (see also CITROËN®, PEUGEOT®)</p>	<p>HU83CRS7N</p> 	<p>4 Buttons - Flip NO battery holder</p>	<table border="1"> <thead> <tr> <th>MODELS</th> <th>YEAR FROM</th> <th>YEAR TO</th> <th>TRANSPONDER TYPE</th> <th>TRP ID</th> </tr> </thead> <tbody> <tr> <td>PHEDRA</td> <td>2006</td> <td></td> <td>PH-CR2</td> <td>46</td> </tr> </tbody> </table>	MODELS	YEAR FROM	YEAR TO	TRANSPONDER TYPE	TRP ID	PHEDRA	2006		PH-CR2	46															
MODELS	YEAR FROM	YEAR TO	TRANSPONDER TYPE	TRP ID																								
PHEDRA	2006		PH-CR2	46																								
<p>LANCIA® (see also FIAT®)</p>	<p>SIP22RS8</p> 	<p>3 Buttons - Flip</p>	<table border="1"> <thead> <tr> <th>MODELS</th> <th>YEAR FROM</th> <th>YEAR TO</th> <th>TRANSPONDER TYPE</th> <th>TRP ID</th> </tr> </thead> <tbody> <tr> <td>LYBRA</td> <td>2002</td> <td>2006</td> <td>MEG-CR</td> <td>48</td> </tr> <tr> <td>MUSA</td> <td>2004</td> <td>2009</td> <td>MEG-CR</td> <td>48</td> </tr> <tr> <td>THESIS</td> <td>2002</td> <td>2009</td> <td>MEG-CR</td> <td>48</td> </tr> <tr> <td>YPSILON</td> <td>2003</td> <td>2011</td> <td>MEG-CR</td> <td>48</td> </tr> </tbody> </table>	MODELS	YEAR FROM	YEAR TO	TRANSPONDER TYPE	TRP ID	LYBRA	2002	2006	MEG-CR	48	MUSA	2004	2009	MEG-CR	48	THESIS	2002	2009	MEG-CR	48	YPSILON	2003	2011	MEG-CR	48
MODELS	YEAR FROM	YEAR TO	TRANSPONDER TYPE	TRP ID																								
LYBRA	2002	2006	MEG-CR	48																								
MUSA	2004	2009	MEG-CR	48																								
THESIS	2002	2009	MEG-CR	48																								
YPSILON	2003	2011	MEG-CR	48																								

* The uses of the keys are purely indicative and may be subject to updates and revisions. / Gli utilizzi delle chiavi sono da considerarsi puramente indicativi e possono essere oggetto di aggiornamenti e revisioni. / Die Abbildung und technischen Daten der Schlüssel sind nicht bindend. Silca behält sich Änderungen am Produkt, die zur Verbesserung beitragen, vor. / Les usages des clés sont purement indicatifs; ils peuvent être mis à jour et revus. / Los usos de las llaves deben considerarse puramente indicativos y pueden ser objeto de actualizaciones y revisiones. / As utilizações das chaves devem ser consideradas puramente indicativas e podem ser objecto de actualizações e revisões.

© Registered Trade Marks / © Marchi Registrati / © Eingetragene Warenzeichen / © Sont des marques déposées / © Son marcas registradas / © Indicam marcas registadas

<p>PEUGEOT® (see also CITROËN®)</p>	<p>HU83ARS2N</p> 	<p>2 Buttons - Flip NO battery holder</p>	<table border="1"> <thead> <tr> <th>MODELS</th> <th>YEAR FROM</th> <th>YEAR TO</th> <th>TRANSPONDER TYPE</th> <th>TRP ID</th> </tr> </thead> <tbody> <tr> <td>207</td> <td>2006</td> <td></td> <td>PH-CR2</td> <td>46</td> </tr> <tr> <td>307</td> <td>2001</td> <td>2009</td> <td>PH-CR2</td> <td>46</td> </tr> <tr> <td>EXPERT</td> <td>2007</td> <td></td> <td>PH-CR2</td> <td>46</td> </tr> </tbody> </table>	MODELS	YEAR FROM	YEAR TO	TRANSPONDER TYPE	TRP ID	207	2006		PH-CR2	46	307	2001	2009	PH-CR2	46	EXPERT	2007		PH-CR2	46					
MODELS	YEAR FROM	YEAR TO	TRANSPONDER TYPE	TRP ID																								
207	2006		PH-CR2	46																								
307	2001	2009	PH-CR2	46																								
EXPERT	2007		PH-CR2	46																								
<p>PEUGEOT® (see also CITROËN®, LANCIA®)</p>	<p>HU83BRS8N</p> 	<p>3 Buttons - Flip NO battery holder</p>	<table border="1"> <thead> <tr> <th>MODELS</th> <th>YEAR FROM</th> <th>YEAR TO</th> <th>TRANSPONDER TYPE</th> <th>TRP ID</th> </tr> </thead> <tbody> <tr> <td>308</td> <td>2007</td> <td></td> <td>PH-CR2</td> <td>46</td> </tr> <tr> <td>807</td> <td>2006</td> <td></td> <td>PH-CR2</td> <td>46</td> </tr> <tr> <td>3008</td> <td>2009</td> <td></td> <td>PH-CR2</td> <td>46</td> </tr> <tr> <td>5008</td> <td>2009</td> <td></td> <td>PH-CR2</td> <td>46</td> </tr> </tbody> </table>	MODELS	YEAR FROM	YEAR TO	TRANSPONDER TYPE	TRP ID	308	2007		PH-CR2	46	807	2006		PH-CR2	46	3008	2009		PH-CR2	46	5008	2009		PH-CR2	46
MODELS	YEAR FROM	YEAR TO	TRANSPONDER TYPE	TRP ID																								
308	2007		PH-CR2	46																								
807	2006		PH-CR2	46																								
3008	2009		PH-CR2	46																								
5008	2009		PH-CR2	46																								
<p>PEUGEOT® (see also CITROËN®, LANCIA®)</p>	<p>HU83CRS7</p> 	<p>4 Buttons - Flip</p>	<table border="1"> <thead> <tr> <th>MODELS</th> <th>YEAR FROM</th> <th>YEAR TO</th> <th>TRANSPONDER TYPE</th> <th>TRP ID</th> </tr> </thead> <tbody> <tr> <td>807</td> <td>2006</td> <td></td> <td>PH-CR2</td> <td>46</td> </tr> </tbody> </table>	MODELS	YEAR FROM	YEAR TO	TRANSPONDER TYPE	TRP ID	807	2006		PH-CR2	46															
MODELS	YEAR FROM	YEAR TO	TRANSPONDER TYPE	TRP ID																								
807	2006		PH-CR2	46																								
<p>PEUGEOT® (see also CITROËN®, LANCIA®)</p>	<p>HU83CRS7N</p> 	<p>4 Buttons - Flip NO battery holder</p>	<table border="1"> <thead> <tr> <th>MODELS</th> <th>YEAR FROM</th> <th>YEAR TO</th> <th>TRANSPONDER TYPE</th> <th>TRP ID</th> </tr> </thead> <tbody> <tr> <td>807</td> <td>2006</td> <td></td> <td>PH-CR2</td> <td>46</td> </tr> </tbody> </table>	MODELS	YEAR FROM	YEAR TO	TRANSPONDER TYPE	TRP ID	807	2006		PH-CR2	46															
MODELS	YEAR FROM	YEAR TO	TRANSPONDER TYPE	TRP ID																								
807	2006		PH-CR2	46																								

* The uses of the keys are purely indicative and may be subject to updates and revisions. / Gli utilizzi delle chiavi sono da considerarsi puramente indicativi e possono essere oggetto di aggiornamenti e revisioni. / Die Abbildung und technischen Daten der Schlüssel sind nicht bindend. Silca behält sich Änderungen am Produkt, die zur Verbesserung beitragen, vor. / Les usages des clés sont purement indicatifs; ils peuvent être mis à jour et revus. / Los usos de las llaves deben considerarse puramente indicativos y pueden ser objeto de actualizaciones y revisiones. / As utilizações das chaves devem ser consideradas puramente indicativas e podem ser objecto de actualizações e revisões.

© Registered Trade Marks / © Marchi Registrati / © Eingetragene Warenzeichen / © Sont des marques déposées / © Son marcas registradas / © Indicam marcas registradas

PEUGEOT® <small>(see also CITROËN®)</small>	VA2ARS2N 	2 Buttons - Flip NO battery holder	<table border="1"> <thead> <tr> <th>MODELS</th> <th>YEAR FROM</th> <th>YEAR TO</th> <th>TRANSPONDER TYPE</th> <th>TRP ID</th> </tr> </thead> <tbody> <tr> <td>407</td> <td>2004</td> <td>2008</td> <td>PH-CR2</td> <td>46</td> </tr> </tbody> </table>	MODELS	YEAR FROM	YEAR TO	TRANSPONDER TYPE	TRP ID	407	2004	2008	PH-CR2	46
MODELS	YEAR FROM	YEAR TO	TRANSPONDER TYPE	TRP ID									
407	2004	2008	PH-CR2	46									
PEUGEOT® <small>(see also CITROËN®)</small>	VA2BRS8N 	3 Buttons - Flip NO battery holder	<table border="1"> <thead> <tr> <th>MODELS</th> <th>YEAR FROM</th> <th>YEAR TO</th> <th>TRANSPONDER TYPE</th> <th>TRP ID</th> </tr> </thead> <tbody> <tr> <td>407</td> <td>2008</td> <td>2011</td> <td>PH-CR2</td> <td>46</td> </tr> </tbody> </table>	MODELS	YEAR FROM	YEAR TO	TRANSPONDER TYPE	TRP ID	407	2008	2011	PH-CR2	46
MODELS	YEAR FROM	YEAR TO	TRANSPONDER TYPE	TRP ID									
407	2008	2011	PH-CR2	46									
PEUGEOT®	VA2CRS7 	4 Buttons - Flip	<table border="1"> <thead> <tr> <th>MODELS</th> <th>YEAR FROM</th> <th>YEAR TO</th> <th>TRANSPONDER TYPE</th> <th>TRP ID</th> </tr> </thead> <tbody> <tr> <td>1007</td> <td>2004</td> <td>2010</td> <td>PH-CR2</td> <td>46</td> </tr> </tbody> </table>	MODELS	YEAR FROM	YEAR TO	TRANSPONDER TYPE	TRP ID	1007	2004	2010	PH-CR2	46
MODELS	YEAR FROM	YEAR TO	TRANSPONDER TYPE	TRP ID									
1007	2004	2010	PH-CR2	46									
PEUGEOT®	VA2CRS7N 	4 Buttons - Flip NO battery holder	<table border="1"> <thead> <tr> <th>MODELS</th> <th>YEAR FROM</th> <th>YEAR TO</th> <th>TRANSPONDER TYPE</th> <th>TRP ID</th> </tr> </thead> <tbody> <tr> <td>1007</td> <td>2004</td> <td>2010</td> <td>PH-CR2</td> <td>46</td> </tr> </tbody> </table>	MODELS	YEAR FROM	YEAR TO	TRANSPONDER TYPE	TRP ID	1007	2004	2010	PH-CR2	46
MODELS	YEAR FROM	YEAR TO	TRANSPONDER TYPE	TRP ID									
1007	2004	2010	PH-CR2	46									

* The uses of the keys are purely indicative and may be subject to updates and revisions. / Gli utilizzi delle chiavi sono da considerarsi puramente indicativi e possono essere oggetto di aggiornamenti e revisioni. / Die Abbildung und technischen Daten der Schlüssel sind nicht bindend. Silca behält sich Änderungen am Produkt, die zur Verbesserung beitragen, vor. / Les usages des clés sont purement indicatifs; ils peuvent être mis à jour et revus. / Los usos de las llaves deben considerarse puramente indicativos y pueden ser objeto de actualizaciones y revisiones. / As utilizações das chaves devem ser consideradas puramente indicativas e podem ser objecto de actualizações e revisões.

® Registered Trade Marks / ® Marchi Registrati / ® Eingetragene Warenzeichen / ® Sont des marques déposées / ® Son marcas registradas / ® Indicam marcas registadas

RENAULT®	NE73ARS1 	1 Button	<table border="1"> <thead> <tr> <th>MODELS</th> <th>YEAR FROM</th> <th>YEAR TO</th> <th>TRANSPONDER TYPE</th> <th>TRP ID</th> </tr> </thead> <tbody> <tr> <td>CLIO</td> <td>1995</td> <td>1998</td> <td>PH</td> <td>33</td> </tr> <tr> <td>ESPACE</td> <td>1997</td> <td>2002</td> <td>PH</td> <td>33</td> </tr> <tr> <td>LAGUNA</td> <td>1995</td> <td>2000</td> <td>PH</td> <td>33</td> </tr> <tr> <td>MASTER</td> <td>1998</td> <td>2001</td> <td>PH</td> <td>33</td> </tr> <tr> <td>MEGANE</td> <td>1996</td> <td>1998</td> <td>PH</td> <td>33</td> </tr> <tr> <td>SAFRANE</td> <td>1995</td> <td>2001</td> <td>PH</td> <td>33</td> </tr> </tbody> </table>	MODELS	YEAR FROM	YEAR TO	TRANSPONDER TYPE	TRP ID	CLIO	1995	1998	PH	33	ESPACE	1997	2002	PH	33	LAGUNA	1995	2000	PH	33	MASTER	1998	2001	PH	33	MEGANE	1996	1998	PH	33	SAFRANE	1995	2001	PH	33
MODELS	YEAR FROM	YEAR TO	TRANSPONDER TYPE	TRP ID																																		
CLIO	1995	1998	PH	33																																		
ESPACE	1997	2002	PH	33																																		
LAGUNA	1995	2000	PH	33																																		
MASTER	1998	2001	PH	33																																		
MEGANE	1996	1998	PH	33																																		
SAFRANE	1995	2001	PH	33																																		
RENAULT®	NE73BRS1 	1 Button	<table border="1"> <thead> <tr> <th>MODELS</th> <th>YEAR FROM</th> <th>YEAR TO</th> <th>TRANSPONDER TYPE</th> <th>TRP ID</th> </tr> </thead> <tbody> <tr> <td>CLIO</td> <td></td> <td>1995</td> <td></td> <td></td> </tr> <tr> <td>LAGUNA</td> <td></td> <td>1995</td> <td></td> <td></td> </tr> <tr> <td>MEGANE</td> <td></td> <td>1995</td> <td></td> <td></td> </tr> </tbody> </table>	MODELS	YEAR FROM	YEAR TO	TRANSPONDER TYPE	TRP ID	CLIO		1995			LAGUNA		1995			MEGANE		1995																	
MODELS	YEAR FROM	YEAR TO	TRANSPONDER TYPE	TRP ID																																		
CLIO		1995																																				
LAGUNA		1995																																				
MEGANE		1995																																				
SUBARU®	TOY43CRS7N 	4 Buttons NO battery holder	<table border="1"> <thead> <tr> <th>MODELS</th> <th>YEAR FROM</th> <th>YEAR TO</th> <th>TRANSPONDER TYPE</th> <th>TRP ID</th> </tr> </thead> <tbody> <tr> <td>BRZ</td> <td>2012</td> <td></td> <td>TEX/MA</td> <td>6E</td> </tr> </tbody> </table>	MODELS	YEAR FROM	YEAR TO	TRANSPONDER TYPE	TRP ID	BRZ	2012		TEX/MA	6E																									
MODELS	YEAR FROM	YEAR TO	TRANSPONDER TYPE	TRP ID																																		
BRZ	2012		TEX/MA	6E																																		
TOYOTA®	TOY43CRS7N 	4 Buttons NO battery holder	<table border="1"> <thead> <tr> <th>MODELS</th> <th>YEAR FROM</th> <th>YEAR TO</th> <th>TRANSPONDER TYPE</th> <th>TRP ID</th> </tr> </thead> <tbody> <tr> <td>COROLLA</td> <td>2011</td> <td></td> <td>TEX/MA</td> <td>6E</td> </tr> <tr> <td>GT 86</td> <td>2012</td> <td></td> <td>TEX/MA</td> <td>6E</td> </tr> <tr> <td>VERSO-S</td> <td>2011</td> <td></td> <td>TEX/MA</td> <td>6E</td> </tr> <tr> <td>YARIS</td> <td>2011</td> <td></td> <td>TEX/MA</td> <td>6E</td> </tr> </tbody> </table>	MODELS	YEAR FROM	YEAR TO	TRANSPONDER TYPE	TRP ID	COROLLA	2011		TEX/MA	6E	GT 86	2012		TEX/MA	6E	VERSO-S	2011		TEX/MA	6E	YARIS	2011		TEX/MA	6E										
MODELS	YEAR FROM	YEAR TO	TRANSPONDER TYPE	TRP ID																																		
COROLLA	2011		TEX/MA	6E																																		
GT 86	2012		TEX/MA	6E																																		
VERSO-S	2011		TEX/MA	6E																																		
YARIS	2011		TEX/MA	6E																																		

* The uses of the keys are purely indicative and may be subject to updates and revisions. / Gli utilizzi delle chiavi sono da considerarsi puramente indicativi e possono essere oggetto di aggiornamenti e revisioni. / Die Abbildung und technischen Daten der Schlüssel sind nicht bindend. Silca behält sich Änderungen am Produkt, die zur Verbesserung beitragen, vor. / Les usages des clés sont purement indicatifs; ils peuvent être mis à jour et revus. / Los usos de las llaves deben considerarse puramente indicativos y pueden ser objeto de actualizaciones y revisiones. / As utilizações das chaves devem ser consideradas puramente indicativas e podem ser objecto de actualizações e revisões.

® Registered Trade Marks / ® Marchi Registrati / ® Eingetragene Warenzeichen / ® Sont des marques déposées / ® Son marcas registradas / ® Indicam marcas registradas



Silca is attending the 2014 ELF Convention From 22th to 25th May Come visit us!

ELF Convention 2014

Silca is attending the annual Congress of the European Locksmith Federation, which will be held in Florence (Italy), from 22th to 25th May 2014, at the Firenze Fiera Congress Center.

Come visit us at Stand 18/19, 2nd Floor, to discover our latest keys, ground-breaking key cutting machines and integrated automotive solutions.

ELF Convention 2014

Silca parteciperà al Congresso annuale della European Locksmith Federation, che si terrà a Firenze, dal 22 al 25 Maggio, presso il Centro Congressi di Firenze Fiera.

Vieni a visitare lo Stand 18/19, 2° Piano, per scoprire le ultime novità Silca: chiavi innovative, macchine duplicatrici all'avanguardia e soluzioni automotive integrate.

ELF Convention 2014

Silca wird am jährlich stattfindenden Kongress des Verbandes europäischer Schlosser (European Locksmith Federation), der vom 22. bis 25. Mai 2014 in dem Firenze Fiera Kongresszentrum in Florenz (Italien) veranstaltet wird, teilnehmen.

Besuchen Sie uns am Stand 18/19 im 2. Stock, um unsere neuesten Schlüssel und Schlüsselfräsmaschinen sowie integrierte Lösungen für Fahrzeugschlüssel zu entdecken.

ELF Convention 2014

Silca participera au Congrès annuel de la Fédération Européenne Serruriers (European Locksmith Federation), qui se tiendra à Florence (Italie), du 22 au 25 mai 2014, au Centre des Congrès de Firenze Fiera.

Venez nous rendre visite au Stand 18/19, 2^e Étage, à découvrir nos dernières clés, nos machines innovatives à tailler les clés et nos solutions automobile intégrées.

ELF Convention 2014

Silca asistirá al Congreso anual de la Federación Europea de Cerrajería (European Locksmith Federation), que tendrá lugar en Florencia (Italia), del 22 al 25 de Mayo de 2014, en el Centro de Congresos de Firenze Fiera.

Venga a visitarnos en el Stand 18/19, 2^a Planta, para descubrir nuestras últimas llaves, máquinas duplicadoras innovadoras y soluciones integradas para el automotivo.

ELF Convention 2014

Silca participará do congresso anual da Federação Europeia Serralheiros (European Locksmith Federation), que será realizada em Florença (Itália), de 22 a 25 Maio 2014, no Centro de Congressos de Firenze Fiera.

Venha visitar-nos no Estande 18/19, 2^o andar, para descobrir as nossas últimas chaves, máquinas duplicadoras inovadoras e soluções integradas para o setor automotivo.



More info on www.elf2014.com



THE CAR BOOK 4 IS NOW ONLINE

DISCOVER IT ON WWW.SILCA.BIZ

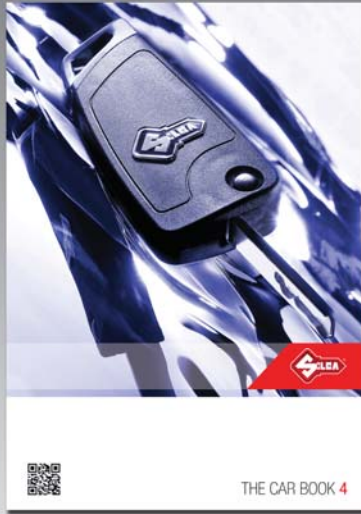

THE CAR BOOK 4 CATALOGUE

THE CAR BOOK 4



THE CAR BOOK 4

The new and updated issue of "The Car Book 4", the exclusive Silca catalogue dedicated to vehicle keys used on the car, motorbike and truck models currently on the market, is now available and entirely downloadable from our website www.silca.biz. Click here for more info.



THE CAR BOOK 4

È ora disponibile la nuova edizione, completamente aggiornata, del "The Car Book 4", l'esclusivo catalogo Silca dedicato alle chiavi dei veicoli attualmente presenti nel mercato. Il catalogo è interamente consultabile e scaricabile dal sito www.silca.biz. Per ulteriori informazioni clicca qui.



THE CAR BOOK 4

Die neue und aktualisierte Ausgabe von "The Car Book 4", dem exklusiven Silca Katalog für Fahrzeugschlüssel für die meistverkauften Fahrzeugmodelle auf dem Markt, ist ab sofort verfügbar. Sie können den gesamten Katalog von unserer Website www.silca.biz herunterladen. Klicken Sie hier für weitere Informationen.

ALWAYS UPDATED ONLINE

You can also keep pace with Silca's automotive innovation on the **Silca Electronic Key Catalogue** ekc.silca.biz, available online and on your smartphone.

The Silca electronic catalogue will be updated in real time with all the new keys making it the ideal assistant for all office activities, the management of stock references, automatic creation of orders, printing packing lists and much more.

SEMPRE AGGIORNATO ONLINE

Rimani al passo con l'innovazione Silca automotive attraverso il **Catalogo Elettronico Chiavi Silca** ekc.silca.biz, consultabile online e su smartphone.

Il catalogo elettronico Silca è aggiornato in tempo reale con tutte le ultime novità ed è l'assistente ideale per le attività di ufficio, per la gestione delle referenze a magazzino, per la creazione automatica di ordini, la stampa di bindelli e molto altro ancora.

IMMER ONLINE AKTUALISIERT

Durch den Elektronischen Schlüsselkatalog sind Sie stets über Silca's Lösungen für Fahrzeugschlüssel informiert. **Der Elektronische Schlüsselkatalog, der in Echtzeit aktualisiert wird, ist online und auf Ihrem Smartphone verfügbar.** Er ist das ideale Hilfsmittel für die Arbeit im Büro, die Verwaltung des Lagerbestands, die automatische Erstellung von Bestellungen, den Ausdruck von Verpackungsetiketten und vieles mehr.

Keep updated on ekc.silca.biz and www.silca.biz!



ELECTRONIC KEY CATALOGUE WEB AND MOBILE

THE CAR BOOK 4



THE CAR BOOK 4

La nouvelle édition, complètement mise à jour, du "The Car Book 4" - le catalogue exclusif Silca dédié aux clés transpondeur et non-transpondeur utilisées pour les modèles de véhicules actuellement sur le marché, est maintenant disponible et téléchargeable entièrement depuis notre site www.silca.biz. Cliquez ici pour savoir en plus.



THE CAR BOOK 4

La nueva edición, totalmente actualizada, del "The Car Book 4", el exclusivo catálogo Silca dedicado a las llaves transponder y non transponder de los vehículos actualmente en el mercado está ahora disponible. El catálogo está totalmente descargable desde el sitio www.silca.biz. Para más información clique aquí.



THE CAR BOOK 4

Já está disponível a nova edição, totalmente atualizada, do "The Car Book 4", o exclusivo catálogo Silca dedicado as chaves transponder e non transponder dos veículos atualmente no mercado. Você pode baixar todo o catálogo do site www.silca.biz. Para mais informações clique aqui.

TOUJOURS MIS À JOUR EN LIGNE

Vous pouvez également suivre l'innovation automobile de Silca sur le Catalogue Electronique Clés Silca ekc.silca.biz, disponible en ligne et sur votre smartphone.

Le catalogue électronique Silca, actualisé en temps réel avec toutes les dernières nouveautés, est l'assistant idéal des activités administratives comme la gestion des références en stock, l'impression des news, la création automatique des commandes et bien plus encore.

SIEMPRE ACTUALIZADO EN LÍNEA

Manténgase al día con la innovación automotiva Silca a través del Catálogo Electrónico Llaves Silca ekc.silca.biz, disponible en línea y en su smartphone.

El catálogo electrónico Silca, actualizado en tiempo real sobre todas las novedades, es el asistente ideal para las actividades de la oficina, gestionar las referencias en stock, crear automáticamente los pedidos, imprimir etiquetas y mucho más.

SEMPRE ATUALIZADO ONLINE

Mantenha-se atualizado com a inovação automotiva Silca através do Catálogo Eletrônico Chaves Silca ekc.silca.biz, disponível online e em seu smartphone.

O catálogo eletrônico Silca, atualizado em tempo real com todas as novidades, é o assistente ideal para o escritório, para a gestão das referências de estoque, para a criação automática de pedidos, imprimir etiquetas e muito mais.

Keep updated on ekc.silca.biz and www.silca.biz!



SILCA KEY PROGRAMS Update 1/2014



www.silca.biz

SILCA KEY PROGRAMS - Update 1/2014

New Silca Key Programs 1/2014 Update for all WEB and DVD subscribers available on the "News" section of Silca Key Programs. New items include:

- Added Dutch language
- Updated comparative list

SILCA KEY PROGRAMS - Aktualisierung 1/2014

Die neue Aktualisierung Silca Key Programs 1/2014 für alle WEB und DVD Abonnenten ist in der Sektion "Neuheiten" des Silca Key Programs verfügbar. Unter den Neuheiten:

- Hinzugefügt wurde die niederländische Sprache
- Die Vergleichsliste wird aktualisiert

SILCA KEY PROGRAMS - Actualización 1/2014

Nueva actualización Silca Key Programs 1/2014 para todos los abonados WEB y DVD disponible en la sección "Novedades" de Silca Key Programs. Entre las novedades:

- Añadido el idioma Holandés
- Actualización del comparativo

SILCA KEY PROGRAMS - Aggiornamento 1/2014

Nuovo Aggiornamento Silca Key Programs 1/2014 per tutti gli abbonati WEB e DVD consultabile nella sezione "Novità" di Silca Key Programs. Tra le novità:

- Aggiunta della lingua Olandese
- Aggiornamento dei comparativi

SILCA KEY PROGRAMS - Mise à jour 1/2014

Nouvelle mise à jour Silca Key Programs 1/2014 pour tous les abonnés WEB et DVD disponible dans la section "Nouveautés" de Silca Key Programs. Parmi les nouveautés:

- Ajout de la langue Hollandaise
- Mise à jour des comparatifs

SILCA KEY PROGRAMS - Atualização 1/2014

Nova atualização Silca Key Programs 1/2014 para todos os assinantes WEB e DVD disponível na seção "Novedades" de Silca Key Programs. Entre as novidades:

- Adicionado a língua holandesa
- Atualização dos comparativos

More info on www.silca.biz



Silca Key Programs

Update 1/2014

SKP Update Version 20.2.x.xx

NEW

SILCA CODE PROGRAM - UPDATES

5 new data cards



Unocode 199



Unocode 299/399



Unocode 399 Evo

Data update with 5 new cutting cards

New items include:

- Ruko® Triton Tip -> Head
- Ruko® Triton Head ->Tip
- Assa® Triton Tip -> Head
- Assa® Triton Head ->Tip
- Brisant® E

(Update the software on UC199, UC299, UC399 and UC399 EVO).

Datenaktualisierung mit 5 neuen Karten

Unter den Neuheiten:

- Ruko® Triton Tip -> Head
- Ruko® Triton Head ->Tip
- Assa® Triton Tip -> Head
- Assa® Triton Head ->Tip
- Brisant® E

(Aktualisierung der Software von UC199, UC299, UC399 und UC399 EVO).

Actualización datos con 5 fichas nuevas

Entre las novedades:

- Ruko® Triton Tip -> Head
- Ruko® Triton Head ->Tip
- Assa® Triton Tip -> Head
- Assa® Triton Head ->Tip
- Brisant® E

(Actualizar el software de UC199, UC299, UC399 y UC399 EVO).

Aggiornamento dati con 5 nuove schede

Tra le novità:

- Ruko® Triton Tip -> Head
- Ruko® Triton Head ->Tip
- Assa® Triton Tip -> Head
- Assa® Triton Head ->Tip
- Brisant® E

(Aggiornare il software di UC199, UC299, UC399 e UC399 EVO).

Mise à jour des données avec 5 fiches

Parmi les nouveautés:

- Ruko® Triton Tip -> Head
- Ruko® Triton Head ->Tip
- Assa® Triton Tip -> Head
- Assa® Triton Head ->Tip
- Brisant® E

(Mettre à jour le logiciel de UC199/UC299/399 et UC399 EVO).

Atualização dados com 5 fichas novas

Entre as novidades:

- Ruko® Triton Tip -> Head
- Ruko® Triton Head ->Tip
- Assa® Triton Tip -> Head
- Assa® Triton Head ->Tip
- Brisant® E

(Atualizar o software de UC199, UC299, UC399 e UC399 EVO).

NEW

SILCA VIPER PROGRAM - UPDATES

4 new series



Viper

Data update with 4 new series

New items include:

- Kia® Cadenza
- Kia® Soul
- Hyundai® Equus - Centennial
- Dodge® Sprinter

(Update the software on VIPER).

Datenaktualisierung mit 4 neuen Serien

Unter den Neuheiten:

- Kia® Cadenza
- Kia® Soul
- Hyundai® Equus - Centennial
- Dodge® Sprinter

(Aktualisierung der Software von VIPER).

Actualización datos con 4 nuevas series

Entre las novedades:

- Kia® Cadenza
- Kia® Soul
- Hyundai® Equus - Centennial
- Dodge® Sprinter

(Actualizar el software de VIPER).

Aggiornamento dati con 4 nuove serie

Tra le novità:

- Kia® Cadenza
- Kia® Soul
- Hyundai® Equus - Centennial
- Dodge® Sprinter

(Aggiornare il software di VIPER).

Mise à jour des données avec 4 séries

Parmi les nouveautés:

- Kia® Cadenza
- Kia® Soul
- Hyundai® Equus - Centennial
- Dodge® Sprinter

(Mettre à jour le logiciel de VIPER).

Atualização dados com 4 novas séries

Entre as novidades:

- Kia® Cadenza
- Kia® Soul
- Hyundai® Equus - Centennial
- Dodge® Sprinter

(Atualizar o software de VIPER).



NEW

SILCA TRIAX AND QUATTROCODE PROGRAM - UPDATES

17 new series



Triax-e.code



Triax Quattro



Quattrocode

Data update with 17 new series

New items include:

- Kia® Cadenza, Kia® Soul
- Hyundai® Equus - Centennial
- Dodge® Sprinter
- Titan® K5+, Titan® K66
- Iseo® R9 KD Gruppo Azzurro, Iseo® R9 Plus Gruppo Azzurro (Cantiere), Iseo® R9 Plus Gruppo Azzurro (Padronale)
- Brisant®
- Moia®
- Kaba® K6 (K6), Kaba® K8 green (K8G), Kaba® Gemini (K50), Kaba® K8S (K14), Kaba® ExperT pluS S 1.0a (K83A), Kaba® ExperT pluS S 1.0b (K83B)

(Update the software on TRIAX-e.code and TRIAX QUATTRO).

Aggiornamento dati con 17 nuove serie

Tra le novità:

- Kia® Cadenza, Kia® Soul
- Hyundai® Equus - Centennial
- Dodge® Sprinter
- Titan® K5+, Titan® K66
- Iseo® R9 KD Gruppo Azzurro, Iseo® R9 Plus Gruppo Azzurro (Cantiere), Iseo® R9 Plus Gruppo Azzurro (Padronale)
- Brisant®
- Moia®
- Kaba® K6 (K6), Kaba® K8 green (K8G), Kaba® Gemini (K50), Kaba® K8S (K14), Kaba® ExperT pluS S 1.0a (K83A), Kaba® ExperT pluS S 1.0b (K83B)

(Aggiornare il software di TRIAX-e.code e TRIAX QUATTRO).

Datenaktualisierung mit 17 neuen Serien

Unter den Neuheiten:

- Kia® Cadenza, Kia® Soul
- Hyundai® Equus - Centennial
- Dodge® Sprinter
- Titan® K5+, Titan® K66
- Iseo® R9 KD Gruppo Azzurro, Iseo® R9 Plus Gruppo Azzurro (Cantiere), Iseo® R9 Plus Gruppo Azzurro (Padronale)
- Brisant®
- Moia®
- Kaba® K6 (K6), Kaba® K8 green (K8G), Kaba® Gemini (K50), Kaba® K8S (K14), Kaba® ExperT pluS S 1.0a (K83A), Kaba® ExperT pluS S 1.0b (K83B)

(Aktualisierung der Software von: TRIAX-e.code und TRIAX QUATTRO).

Mise à jour des données avec 17 nouvelles séries

Parmi les nouveautés:

- Kia® Cadenza, Kia® Soul
- Hyundai® Equus - Centennial
- Dodge® Sprinter
- Titan® K5+, Titan® K66
- Iseo® R9 KD Gruppo Azzurro, Iseo® R9 Plus Gruppo Azzurro (Cantiere), Iseo® R9 Plus Gruppo Azzurro (Padronale)
- Brisant®
- Moia®
- Kaba® K6 (K6), Kaba® K8 green (K8G), Kaba® Gemini (K50), Kaba® K8S (K14), Kaba® ExperT pluS S 1.0a (K83A), Kaba® ExperT pluS S 1.0b (K83B)

(Mettre à jour le logiciel de TRIAX-e.code et TRIAX QUATTRO).

Actualización datos con 17 series nuevas

Entre las novedades:

- Kia® Cadenza, Kia® Soul
- Hyundai® Equus - Centennial
- Dodge® Sprinter
- Titan® K5+, Titan® K66
- Iseo® R9 KD Gruppo Azzurro, Iseo® R9 Plus Gruppo Azzurro (Cantiere), Iseo® R9 Plus Gruppo Azzurro (Padronale)
- Brisant®
- Moia®
- Kaba® K6 (K6), Kaba® K8 green (K8G), Kaba® Gemini (K50), Kaba® K8S (K14), Kaba® ExperT pluS S 1.0a (K83A), Kaba® ExperT pluS S 1.0b (K83B)

(Actualizar el software de TRIAX-e.code y TRIAX QUATTRO).

Atualização dados com 17 series novas

Entre as novidades:

- Kia® Cadenza, Kia® Soul
- Hyundai® Equus - Centennial
- Dodge® Sprinter
- Titan® K5+, Titan® K66
- Iseo® R9 KD Gruppo Azzurro, Iseo® R9 Plus Gruppo Azzurro (Cantiere), Iseo® R9 Plus Gruppo Azzurro (Padronale)
- Brisant®
- Moia®
- Kaba® K6 (K6), Kaba® K8 green (K8G), Kaba® Gemini (K50), Kaba® K8S (K14), Kaba® ExperT pluS S 1.0a (K83A), Kaba® ExperT pluS S 1.0b (K83B)

(Atualizar o software de TRIAX-e.code e TRIAX QUATTRO).



Silca Key Programs

Update 1/2014

SKP Update Version 20.2.x.xx

NEW

SILCA IDEA AND PRIMA LASER PROGRAM - UPDATES

4 new series



Idea



Prima Laser

Data update with 4 new cutting cards

New items include:

- Mobella® 55
- Mobella® 62
- Mobella® 6601
- Ross® Series 102

(Update the software on IDEA).

Datenaktualisierung mit 4 neuen Serien

Unter den Neuheiten:

- Mobella® 55
- Mobella® 62
- Mobella® 6601
- Ross® Series 102

(Aktualisierung der Software von IDEA).

Actualización datos con 4 series nuevas

Entre las novedades:

- Mobella® 55
- Mobella® 62
- Mobella® 6601
- Ross® Series 102

(Actualizar el software de IDEA).

Aggiornamento dati con 4 nuove serie

Tra le novità:

- Mobella® 55
- Mobella® 62
- Mobella® 6601
- Ross® Series 102

(Aggiornare il software di IDEA).

Mise à jour des données avec 4 séries

Parmi les nouveautés:

- Mobella® 55
- Mobella® 62
- Mobella® 6601
- Ross® Series 102

(Mettre à jour le logiciel de IDEA).

Atualização dados com 4 series novas

Entre as novidades:

- Mobella® 55
- Mobella® 62
- Mobella® 6601
- Ross® Series 102

(Atualizar o software de IDEA).

NEW

SILCA TRANSPONDER PROGRAM - UPDATES



RW4 Plus



Fast Copy Plus



RW4



Fast Copy

 Silca Transponder Program has been updated with **95 new vehicle applications**.

New software version 03.12.071 for all RW devices (RW4, RW4 PLUS, FAST COPY, FAST COPY PLUS) to be able to identify the new PH-CR3 ID47, ID49, ID50 transponder.

(Update the software on RW4, RW4 PLUS, FAST COPY and FAST COPY PLUS).

 Das Silca Transponder Program wurde mit **95 neuen Auto-Applikationen** aktualisiert.

Neue Softwareversion 03.12.071 für alle RW-Geräte (RW4, RW4 PLUS, FAST COPY, FAST COPY PLUS) sind jetzt in der Lage **die neue PH-CR3 ID47, ID49, ID50 Transponder zu identifizieren**.

(Aktualisierung der Software von RW4, RW4 PLUS, FAST COPY und FAST COPY PLUS).

 Se ha actualizado el Silca Transponder Program con **95 nuevas aplicaciones vehículo**. **Nueva versión de software 03.12.071** para todos los dispositivos RW (RW4, RW4 PLUS, FAST COPY, FAST COPY PLUS) para **identificar el nuevo transponder PH-CR3 ID47, ID49, ID50**.

(Actualizar el software de RW4, RW4 PLUS, FAST COPY y FAST COPY PLUS).

 Il Silca Transponder Program è stato aggiornato con **95 nuove applicazioni auto**.

Nuova versione Software 03.12.071 per tutti i dispositivi RW (RW4, RW4 PLUS, FAST COPY, FAST COPY PLUS) **per identificare il nuovo transponder PH-CR3 ID47, ID49, ID50**.

(Aggiornare il software di RW4, RW4 PLUS, FAST COPY e FAST COPY PLUS).

 Silca Transponder Program a été mis à jour avec **95 nouvelles applications auto**.

Nouvelle version Software 03.12.071 pour tous les dispositifs Transponder (RW4, RW4 PLUS, FAST COPY, FAST COPY PLUS) pour **identifier le nouveau transponder PH-CR3 ID47, ID49, ID50**.





(Mettre à jour le logiciel de RW4, RW4 PLUS, FAST COPY et FAST COPY PLUS).

 O Silca Transponder Program foi atualizado com **95 novas aplicações para automóvel**.

Nova versão de software 03.12.071 para todos os dispositivos RW (RW4, RW4 PLUS, FAST COPY, FAST COPY PLUS) que lhe permitirá **identificar novos transponder PH-CR3 ID47, ID49, ID50**.

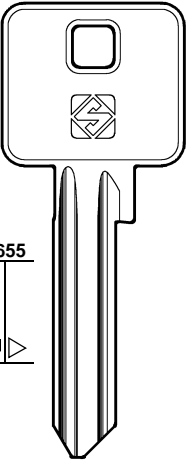
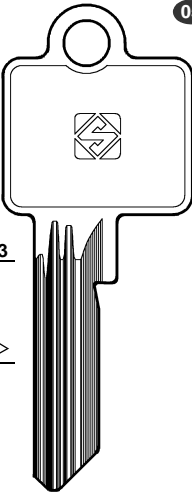
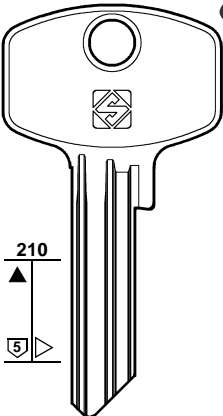
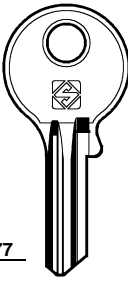
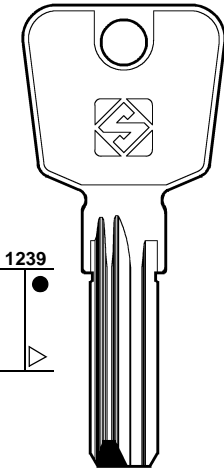
(Atualizar o software de RW4, RW4 PLUS, FAST COPY e FAST COPY PLUS).

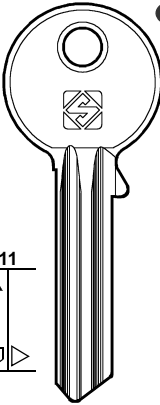
New Keys / Chiavi Nuove / Neue Schlüssel / Nouvelles Clés
Llaves Nuevas / Chaves Nuevas

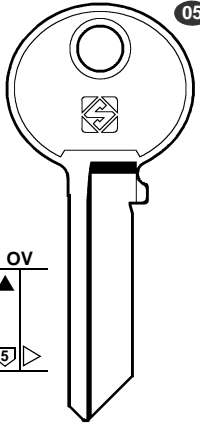
FOR: PER:	ABUS	BKS	DOM		FOR / PER
	 <p>1655</p> <p>AB98</p>	 <p>1423</p> <p>BK52 10 BK53 16</p>	 <p>210</p> <p>DM152</p>	 <p>277</p> <p>DM153</p>	ABUS (D) BKS (D) DOM (D) SÜDMETALL (D) TRELOCK (D) WILKA (D)
FOR: PER:	SÜDMETALL	TRELOCK	WILKA		
	 <p>1239</p> <p>SDT1R</p> 	 <p>11</p> <p>TRK9 TRK9R</p>  	 <p>OV</p> <p>WK62R</p>		01 COMMERCIAL GROUP GRUPPO COMMERCIALE PREISEGRUPPE GROUPE COMMERCIAL GRUPO COMMERCIAL GRUPO COMERCIAL www.silca.biz

FOR / PER
DAIHATSU (J)
HYUNDAI (ROK)
SSANGYONG (ROK)
TOYOTA (J)
TRW SIPEA (I)

FOR: **DAIHATSU**
PER:

96

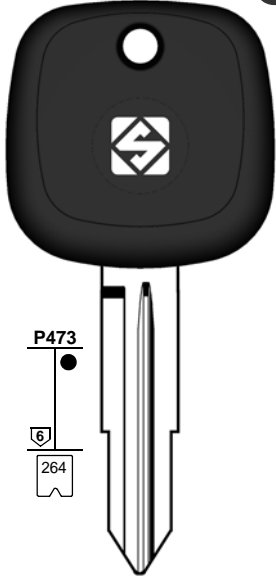

P473



264



DH5RTE
D 3001-4000



Key with Adapter / without Transponder chip
Chiave con Adattatore / senza Transponder chip
Schlüssel mit Adapter / ohne Transponder chip
Clé avec Adaptateur / sans Transpondeur chip
Llaves con Adaptador / sin Transponder chip
Chave com Adaptador / sem Transponder chip

FOR: **HYUNDAI**
PER:

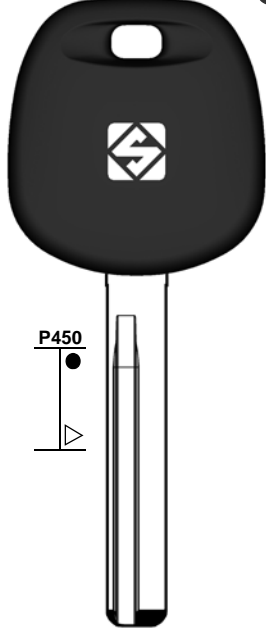
97

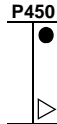

P450

HYN17BTE



HYN17RBTE

Key with Adapter / without Transponder chip
Chiave con Adattatore / senza Transponder chip
Schlüssel mit Adapter / ohne Transponder chip
Clé avec Adaptateur / sans Transpondeur chip
Llaves con Adaptador / sin Transponder chip
Chave com Adaptador / sem Transponder chip

FOR: **SSANGYONG**
PER:

96

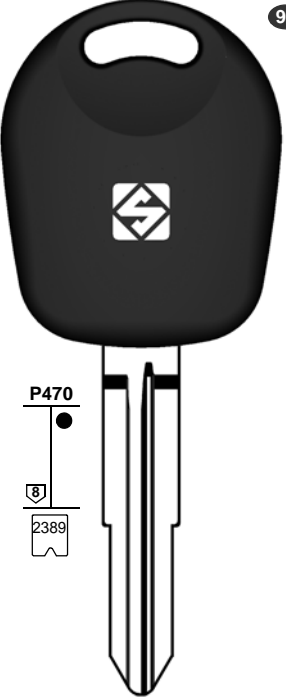

P470



2389



SSY3TE
SK 1-1000
KH 1-1000

Key with Adapter / without Transponder chip
Chiave con Adattatore / senza Transponder chip
Schlüssel mit Adapter / ohne Transponder chip
Clé avec Adaptateur / sans Transpondeur chip
Llaves con Adaptador / sin Transponder chip
Chave com Adaptador / sem Transponder chip

FOR: **TOYOTA**
PER:

97

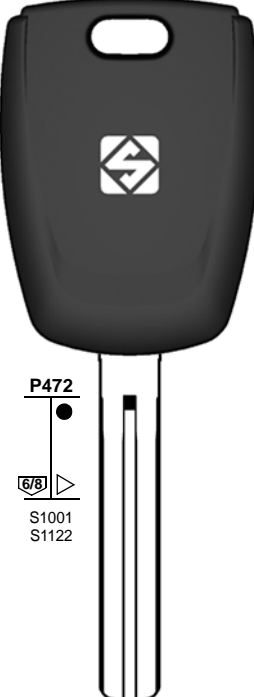

P472



S1001
S1122



TOY49TE
K 0001-2500
P 0001-2500

Key with Adapter / without Transponder chip
Chiave con Adattatore / senza Transponder chip
Schlüssel mit Adapter / ohne Transponder chip
Clé avec Adaptateur / sans Transpondeur chip
Llaves con Adaptador / sin Transponder chip
Chave com Adaptador / sem Transponder chip

FOR: **TRW SIPEA**
PER:

97

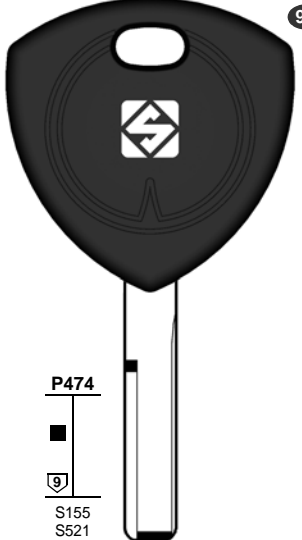

P474

















S155
S521



SIP16TE
. . . . 1-17735
LA 1-17735

Key with Adapter / without Transponder chip
Chiave con Adattatore / senza Transponder chip
Schlüssel mit Adapter / ohne Transponder chip
Clé avec Adaptateur / sans Transpondeur chip
Llaves con Adaptador / sin Transponder chip
Chave com Adaptador / sem Transponder chip

01
COMMERCIAL GROUP
GRUPPO COMMERCIALE
PREISEGRUPPE
GROUPE COMMERCIAL
GRUPO COMMERCIAL
GRUPO COMERCIAL
www.silca.biz

1	2	2a	3	3a	3b	E1+E2		6	42+71	72	43 44a	12	15
						GTI COMPATIBLE		IGNITION 					
CAR MAKE MODEL	FROM	TO	SILCA REF.	SILCA REF.	SILCA REF.	COPY	GEN.	TRANSP. TYPE	FAST COPY PLUS RW4 PLUS FAST COPY / RW4	FAST COPY PLUS RW4 PLUS	FAST COPY RW4	STP	
													

For more info on the uses of car keys, refer to the Silca Electronic Key Catalogue:



ALFA ROMEO®

166	2000	2004	SIP16MH	SIP16TE	SIP16FH*	Y		PH / CR2	46	Y	P-BOX		
-----	------	------	---------	---------	----------	---	--	----------	----	---	-------	--	--

DAIHATSU®

CUORE	1998	2006	DH5RMH	DH5RTE	DH5RFH*	Y	Y	TEXAS	4C	Y	P-BOX		
MOVE	1997	2002	DH5RMH	DH5RTE	DH5RFH*	Y	Y	TEXAS	4C	Y	P-BOX		

HYUNDAI®

ACCENT (AUS)	2012			HYN17BTE		Y		PH / CR2	46	Y	P-BOX		
I20	2008		TOY49MH	TOY49TE	TOY49FH*	Y	Y	PH / CR2	46	Y	P-BOX		
I30	2007	2011	TOY49MH	TOY49TE	TOY49FH*	Y	Y	PH / CR2	46	Y	P-BOX		
I40 (AUS)	2010		TOY49MH	TOY49TE	TOY49FH*	Y	Y	PH / CR2	46	Y	P-BOX		
I45	2009		TOY49MH	TOY49TE	TOY49FH*	Y	Y	PH / CR2	46	Y	P-BOX		
IX20	2010		TOY49MH	TOY49TE	TOY49FH*	Y	Y	PH / CR2	46	Y	P-BOX		
IX35	2010		TOY49MH	TOY49TE	TOY49FH*	Y	Y	PH / CR2	46	Y	P-BOX		
SANTA FE (AUS)	2013			HYN17RBTE		Y		PH / CR2	46	Y	P-BOX		
VELOSTER (AUS)	2012			HYN17BTE		Y		PH / CR2	46	Y	P-BOX		

KIA®

BORREGO	2009	2011	TOY49MH	TOY49TE	TOY49FH*	Y	Y	PH / CR2	46	Y	P-BOX		
MAGENTIS	2009	2011	TOY49MH	TOY49TE	TOY49FH*	Y	Y	PH / CR2	46	Y	P-BOX		
OPIRUS	2007	2010	TOY49MH	TOY49TE	TOY49FH*	Y	Y	PH / CR2	46	Y	P-BOX		
RIO	2010	2011	TOY49MH	TOY49TE	TOY49FH*	Y	Y	PH / CR2	46	Y	P-BOX		

SSANGYONG®

ACTYON	2007		SSY3MH	SSY3TE	SSY3FH*	Y	Y	TEX / CR	60	Y	P-BOX		
KYRON	2005		SSY3MH	SSY3TE	SSY3FH*	Y	Y	TEX / CR	60	Y	P-BOX		
REXTON	2006		SSY3MH	SSY3TE	SSY3FH*	Y	Y	TEX / CR	60	Y	P-BOX		



IMPORTANT NOTE:

See also the "Vehicle Guide Legend"
Vedi anche la "Legenda Guida Veicoli"
Siehe auch die "Fahrzeugschlüssel Erläuterung"
Voir aussi la "Légende Guide Véhicules"
Véase también la "Leyenda Guía para Vehículos"
Veja também a "Legenda Guia para Veículos"

SILCA EMPTY SHELLS - NEW REFERENCES

 Silca Empty Shells: **4 new keys references** to widen the existing range.

 Silca Empty Shells: **4 nouvelles références** clés qui complètent la gamme existante.

 Silca Empty Shells: **4 nuove referenze** chiavi che implementano la gamma già esistente.

 Silca Empty Shells: **4 nuevas referencias** llaves que completan la gama existente.

 Silca Empty Shells: **4 Schlüssel Referenzen** die das bestehende Angebot implementieren.

 Silca Empty Shells: **4 novas referências** chaves que implementam a gama existente.

Brand	Part Number/Image	Application*/Utilization*	Models*				
			MODELS	YEAR FROM	YEAR TO	TRANSPONDER TYPE	TRP ID
CITROËN® (see also PEUGEOT®)	VA2BRS2 	2 Buttons - Flip	BERLINGO	2008		PH-CR2	46
			C2	2006		PH-CR2	46
CITROËN® (see also PEUGEOT®)	VA2BRS8 	3 Buttons - Flip	C3 PICASSO	2008		PH-CR2	46
			C5	2006	2008	PH-CR2	46
LEXUS® (see also TOYOTA®)	TOYRS8 	Lexus®/Toyota® 3 Buttons - Spare part	Rubber Push Button Spare part for TOY40BRS8, TOY43BRS8, TOY48BRS8 references				

* The uses of the keys are purely indicative and may be subject to updates and revisions. / Gli utilizzi delle chiavi sono da considerarsi puramente indicativi e possono essere oggetto di aggiornamenti e revisioni. / Die Abbildung und technischen Daten der Schlüssel sind nicht bindend. Silca behält sich Änderungen am Produkt, die zur Verbesserung beitragen, vor. / Les usages des clés sont purement indicatifs; ils peuvent être mis à jour et revus. / Los usos de las llaves deben considerarse puramente indicativos y pueden ser objeto de actualizaciones y revisiones. / As utilizações das chaves devem ser consideradas puramente indicativas e podem ser objecto de actualizações e revisões.

© Registered Trademarks. / © Marchi Registrati. / © Eingetragene Marken. / © Marques Déposées. / © Marcas Registradas. / © Marcas Registradas.

<p>PEUGEOT® (see also CITROËN®)</p>	<p>VA2BRS2</p> 	<p>2 Buttons - Flip</p>	<table border="1"> <thead> <tr> <th>MODELS</th> <th>YEAR FROM</th> <th>YEAR TO</th> <th>TRANSPONDER TYPE</th> <th>TRP ID</th> </tr> </thead> <tbody> <tr> <td>407</td> <td>2004</td> <td>2008</td> <td>PH-CR2</td> <td>46</td> </tr> </tbody> </table>	MODELS	YEAR FROM	YEAR TO	TRANSPONDER TYPE	TRP ID	407	2004	2008	PH-CR2	46															
MODELS	YEAR FROM	YEAR TO	TRANSPONDER TYPE	TRP ID																								
407	2004	2008	PH-CR2	46																								
<p>PEUGEOT® (see also CITROËN®)</p>	<p>VA2BRS8</p> 	<p>3 Buttons - Flip</p>	<table border="1"> <thead> <tr> <th>MODELS</th> <th>YEAR FROM</th> <th>YEAR TO</th> <th>TRANSPONDER TYPE</th> <th>TRP ID</th> </tr> </thead> <tbody> <tr> <td>407</td> <td>2008</td> <td>2011</td> <td>PH-CR2</td> <td>46</td> </tr> </tbody> </table>	MODELS	YEAR FROM	YEAR TO	TRANSPONDER TYPE	TRP ID	407	2008	2011	PH-CR2	46															
MODELS	YEAR FROM	YEAR TO	TRANSPONDER TYPE	TRP ID																								
407	2008	2011	PH-CR2	46																								
<p>SEAT® (see also SKODA®, VOLKSWAGEN®)</p>	<p>HURSA8</p> 	<p>3 Buttons</p>	<table border="1"> <thead> <tr> <th>MODELS</th> <th>YEAR FROM</th> <th>YEAR TO</th> <th>TRANSPONDER TYPE</th> <th>TRP ID</th> </tr> </thead> <tbody> <tr> <td>ALTEA</td> <td>2004</td> <td>2008</td> <td>MEG-CR</td> <td>A3</td> </tr> <tr> <td>ALTEA XL</td> <td>2006</td> <td>2008</td> <td>MEG-CR</td> <td>A3</td> </tr> <tr> <td>LEON</td> <td>2005</td> <td>2008</td> <td>MEG-CR</td> <td>A3</td> </tr> <tr> <td>TOLEDO</td> <td>2005</td> <td>2008</td> <td>MEG-CR</td> <td>A3</td> </tr> </tbody> </table>	MODELS	YEAR FROM	YEAR TO	TRANSPONDER TYPE	TRP ID	ALTEA	2004	2008	MEG-CR	A3	ALTEA XL	2006	2008	MEG-CR	A3	LEON	2005	2008	MEG-CR	A3	TOLEDO	2005	2008	MEG-CR	A3
MODELS	YEAR FROM	YEAR TO	TRANSPONDER TYPE	TRP ID																								
ALTEA	2004	2008	MEG-CR	A3																								
ALTEA XL	2006	2008	MEG-CR	A3																								
LEON	2005	2008	MEG-CR	A3																								
TOLEDO	2005	2008	MEG-CR	A3																								
<p>SKODA® (see also SEAT®, VOLKSWAGEN®)</p>	<p>HURSA8</p> 	<p>3 Buttons</p>	<table border="1"> <thead> <tr> <th>MODELS</th> <th>YEAR FROM</th> <th>YEAR TO</th> <th>TRANSPONDER TYPE</th> <th>TRP ID</th> </tr> </thead> <tbody> <tr> <td>OCTAVIA</td> <td>2004</td> <td>2006</td> <td>MEG-CR</td> <td>A4</td> </tr> <tr> <td>ROOMSTER</td> <td>2006</td> <td>2008</td> <td>MEG-CR</td> <td>A4</td> </tr> <tr> <td>ROOMSTER SCOUT</td> <td>2007</td> <td>2008</td> <td>MEG-CR</td> <td>A4</td> </tr> </tbody> </table>	MODELS	YEAR FROM	YEAR TO	TRANSPONDER TYPE	TRP ID	OCTAVIA	2004	2006	MEG-CR	A4	ROOMSTER	2006	2008	MEG-CR	A4	ROOMSTER SCOUT	2007	2008	MEG-CR	A4					
MODELS	YEAR FROM	YEAR TO	TRANSPONDER TYPE	TRP ID																								
OCTAVIA	2004	2006	MEG-CR	A4																								
ROOMSTER	2006	2008	MEG-CR	A4																								
ROOMSTER SCOUT	2007	2008	MEG-CR	A4																								

* The uses of the keys are purely indicative and may be subject to updates and revisions. / Gli utilizzi delle chiavi sono da considerarsi puramente indicativi e possono essere oggetto di aggiornamenti e revisioni. / Die Abbildung und technischen Daten der Schlüssel sind nicht bindend. Silca behält sich Änderungen am Produkt, die zur Verbesserung beitragen, vor. / Les usages des clés sont purement indicatifs; ils peuvent être mis à jour et revus. / Los usos de las llaves deben considerarse puramente indicativos y pueden ser objeto de actualizaciones y revisiones. / As utilizações das chaves devem ser consideradas puramente indicativas e podem ser objecto de actualizações e revisões.

® Registered Trademarks. / ® Marchi Registrati. / ® Eingetragene Marken. / ® Marques Déposées. / ® Marcas Registradas. / ® Marcas Registradas.

<p>TOYOTA® (see also LEXUS®)</p>	<p>TOYRS8</p> 	<p>Lexus®/Toyota® 3 Buttons - Spare part</p>	<p>Rubber Push Button Spare part for TOY40BRS8, TOY43BRS8, TOY48BRS8 references</p>																																								
<p>VOLKSWAGEN® (see also SEAT®, SKODA®)</p>	<p>HURSA8</p> 	<p>3 Buttons</p>	<table border="1"> <thead> <tr> <th>MODELS</th> <th>YEAR FROM</th> <th>YEAR TO</th> <th>TRANSPONDER TYPE</th> <th>TRP ID</th> </tr> </thead> <tbody> <tr> <td>CROSS GOLF</td> <td>2006</td> <td>2007</td> <td>MEG-CR</td> <td>A1</td> </tr> <tr> <td>EOS</td> <td>2006</td> <td>2007</td> <td>MEG-CR</td> <td>A1</td> </tr> <tr> <td>GOLF</td> <td>2004</td> <td>2008</td> <td>MEG-CR</td> <td>A1</td> </tr> <tr> <td>INDIVIDUAL</td> <td>2004</td> <td>2008</td> <td>MEG-CR</td> <td>A1</td> </tr> <tr> <td>JETTA</td> <td>2004</td> <td>2007</td> <td>MEG-CR</td> <td>A1</td> </tr> <tr> <td>PASSAT</td> <td>2004</td> <td>2005</td> <td>MEG-CR</td> <td>A1</td> </tr> <tr> <td>TOURAN</td> <td>2003</td> <td>2007</td> <td>MEG-CR</td> <td>A1</td> </tr> </tbody> </table>	MODELS	YEAR FROM	YEAR TO	TRANSPONDER TYPE	TRP ID	CROSS GOLF	2006	2007	MEG-CR	A1	EOS	2006	2007	MEG-CR	A1	GOLF	2004	2008	MEG-CR	A1	INDIVIDUAL	2004	2008	MEG-CR	A1	JETTA	2004	2007	MEG-CR	A1	PASSAT	2004	2005	MEG-CR	A1	TOURAN	2003	2007	MEG-CR	A1
MODELS	YEAR FROM	YEAR TO	TRANSPONDER TYPE	TRP ID																																							
CROSS GOLF	2006	2007	MEG-CR	A1																																							
EOS	2006	2007	MEG-CR	A1																																							
GOLF	2004	2008	MEG-CR	A1																																							
INDIVIDUAL	2004	2008	MEG-CR	A1																																							
JETTA	2004	2007	MEG-CR	A1																																							
PASSAT	2004	2005	MEG-CR	A1																																							
TOURAN	2003	2007	MEG-CR	A1																																							

* The uses of the keys are purely indicative and may be subject to updates and revisions. / Gli utilizzi delle chiavi sono da considerarsi puramente indicativi e possono essere oggetto di aggiornamenti e revisioni. / Die Abbildung und technischen Daten der Schlüssel sind nicht bindend. Silca behält sich Änderungen am Produkt, die zur Verbesserung beitragen, vor. / Les usages des clés sont purement indicatifs; ils peuvent être mis à jour et revus. / Los usos de las llaves deben considerarse puramente indicativos y pueden ser objeto de actualizaciones y revisiones. / As utilizações das chaves devem ser consideradas puramente indicativas e podem ser objecto de actualizações e revisões.

© Registered Trademarks. / © Marchi Registrati. / © Eingetragene Marken. / © Marques Déposées. / © Marcas Registradas. / © Marcas Registradas.

Transponder T33

🇬🇧 Transponder T33

Boost your automotive keys service with Silca's new T33 rewritable glass transponder, that will allow you to copy Megamos® Crypto type transponders (ID48-A and ID48-K) for the most popular Chevrolet-Daewoo®, Kia® and Pontiac® vehicle models. T33 is a reliable CE-certified solution, guaranteed by Silca.

🇮🇹 Transponder T33

Amplia il tuo servizio chiavi automotive con il nuovo transponder riscrivibile in vetro Silca T33, che ti permetterà di copiare transponder di tipo Megamos® Crypto (ID48-A e ID48-K) per i modelli Chevrolet- Daewoo®, Kia® e Pontiac® più diffusi. T33 è una soluzione affidabile e di alta qualità certificata a marchio CE e garantita da Silca.

🇩🇪 Transponder T33

Erweitern Sie Ihren Autoschlüsseldienst mit dem neuen wiederbeschreibbaren Glas-Transponder Silca T33, der es Ihnen ermöglicht, Transponder des Typs Megamos® Crypto (ID48-A und ID48-K) für die wichtigsten Modelle von Chevrolet-Daewoo®, Kia® und Pontiac® zu kopieren. Mit dem T33 erhalten Sie eine zuverlässige Lösung von hoher Qualität, die durch das CE-Zeichen bestätigt und von Silca garantiert wird.

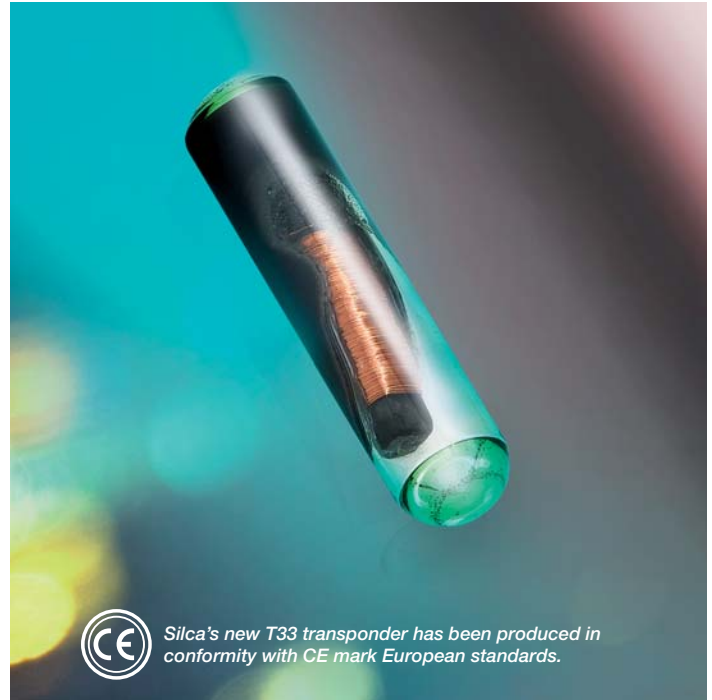

Silca's new T33 transponder has been produced in conformity with CE mark European standards.

🇫🇷 Transpondeur T33

Renforcez votre service de clés automobiles avec le nouveau transpondeur réinscriptible en verre T33 de Silca. Ce dispositif vous permettra de reproduire les transpondeurs de type Megamos® Crypto (ID48-A et ID48-K) pour la plupart des modèles de véhicules des marques Chevrolet-Daewoo®, Kia® et Pontiac®. Le transpondeur T33 est une solution fiable et de haute qualité certifiée par le marquage CE et garantie par Silca.

🇪🇸 Transponder T33

Aumente su negocio de llaves de automoción con el nuevo transponder regrabable de cristal T33 de Silca, que le permitirá copiar los transponders tipo Megamos® Crypto (ID48-A e ID48-K) para los modelos de coche Chevrolet-Daewoo®, Kia® y Pontiac® más populares. El T33 representa una solución fiable y de alta calidad, CE marca certificada y garantizada por Silca.

🇧🇷 Transponder T33

Amplie o seu serviço chaves automotive com o novo transponder re-escrivível de vidro Silca T33, que lhe permitirá copiar transponder tipo Megamos® Crypto (ID48-A e ID48-K) para os modelos Chevrolet-Daewoo®, Kia® e Pontiac® mais difundidos. T33 é uma solução de confiança e de alta qualidade certificada com marca CE e garantida pela Silca.

TRANSPONDER T33 - Uses

CAR MAKE	MODEL	YEAR		SILCA REFERENCE		
		FROM	TO	LOOK A-LIKE	FLIP	WITHOUT TRP
CHEVROLET- DAEWOO®	AVEO	2006	2011	DWO4RTE	DWO4RFH	DWO4RT6*
	KALOS	2002	2006	DWO4RTE	DWO4RFH	DWO4RT6*
	LANOS	2002	2004			
	LACETTI	2002	2004	DWO4RTE	DWO4RFH	DWO4RT6*
	LEGANZA	2000	2008	DWO5TE	DWO5FH	DWO5T6*
	MATIZ	2001	2005			DWO6BT6*
	MATIZ	2006				DWO4CT6*
	NUBIRA	2000	2002	DWO4RTE	DWO4RFH	DWO4RT6*
	NUBIRA	2002	2006			DWO4CT6*
TACUMA	2000	2008	DWO4RTE	DWO4RFH	DWO4RT6*	
KIA®	CARNIVAL	1999	2000	KIA3RTE	KIA3RFH	
	CLARUS	1998	2001	KIA3RTE	KIA3RFH	
	SEDONA	1999	2000	KIA3RTE	KIA3RFH	
	SHUMA	1998	2001	KIA3RTE	KIA3RFH	
	SPORTAGE	1999	2001	KIA3RTE	KIA3RFH	
	PRIDE	1999	2001	KIA3RTE	KIA3RFH	
PONTIAC®	G3	2006	2011	DWO4RTE	DWO4RFH	DWO4RT6*

* You can order these key references without transponder and apply the transponder T33 later on. / È possibile ordinare la referenza indicata nella versione senza transponder e successivamente applicarvi il transponder T33. / Es kann die auf der Schlüsselversion ohne Transponder angegebene Artikelnummer bestellt und der Transponder T33 nachträglich eingesetzt werden. / Vous pouvez commander ces références de clés sans transpondeur et rajouter le transpondeur T33 ultérieurement. / Puede solicitar estas referencias de llaves sin transponder e insertar el transponder T33 después. / É possível encomendar a referência indicada na versão da chave sem transponder e em seguida aplicar o transponder T33. Chevrolet-Daewoo®, Kia®, Megamos® and Pontiac® are Registered Trademarks. / Chevrolet-Daewoo®, Kia®, Megamos® e Pontiac® sono Marchi Registrati. / Chevrolet-Daewoo®, Kia®, Megamos® und Pontiac® sind eingetragene Marken. / Chevrolet-Daewoo®, Kia®, Megamos® et Pontiac® sont des Marques Déposées. / Chevrolet-Daewoo®, Kia®, Megamos® y Pontiac® son Marcas Registradas. / Chevrolet-Daewoo®, Kia®, Megamos® e Pontiac® são Marcas Registradas.



SILCA KEY PROGRAMS Web Update



www.silca.biz

SILCA KEY PROGRAMS - **WEB Update**

A new update of the SILCA KEY PROGRAMS software is available to all WEB subscribers. Check out the "News" section of Silca Key Programs on www.silca.biz to know more.

SILCA KEY PROGRAMS - **Aggiornamento WEB**

È disponibile un nuovo aggiornamento del software SILCA KEY PROGRAMS per tutti gli abbonati WEB. Consulta la sezione "Novità" di Silca Key Programs sul sito www.silca.biz per saperne di più.

SILCA KEY PROGRAMS - **Aktualisierung WEB**

Für alle WEB Abonnenten ist eine neue Aktualisierung von der Software SILCA KEY PROGRAMS verfügbar. Sehen Sie den Abschnitt "Neuheiten" von Silca Key Programs auf www.silca.biz, um weitere Informationen zu finden.

SILCA KEY PROGRAMS - **Mise à jour WEB**

Une nouvelle mise à jour du logiciel SILCA KEY PROGRAMS pour tous les abonnements WEB est disponible. Consultez la section "Nouveautés" de Silca Key Programs sur notre site www.silca.biz pour en savoir plus.

SILCA KEY PROGRAMS - **Actualización WEB**

Una nueva actualización del software SILCA KEY PROGRAMS para todos los abonados WEB está disponible. Visite la sección "Novedades" de Silca Key Programs en el sitio www.silca.biz para más informaciones.

SILCA KEY PROGRAMS - **Atualização WEB**

Nova atualização do software SILCA KEY PROGRAMS para todos o assinantes WEB está disponível. Consulte a seção "Novidades" de Silca Key Programs no site www.silca.biz para saber mais.

More info on www.silca.biz



ELF Convention 2014

UK A very successful convention in which Silca participated as an exhibitor and Silver Sponsor and that was the opportunity to celebrate the 30th anniversary of the European Locksmith Association.

IT Una convention di grande successo a cui Silca ha partecipato quale espositore e Silver Sponsor e che è stata l'occasione di festeggiare il trentennale dell'Associazione dei Locksmith Europei.

DE Ein erfolgreicher Kongress, an dem Silca als Aussteller und Silver Sponsor teilgenommen hat. Er war auch die Gelegenheit, den 30. Jahrestag des Verbandes europäischer Schlosser zu feiern.

FR Une convention très réussie à laquelle Silca a participé comme exposant et Silver Sponsor et qui a été l'occasion pour célébrer le trentième anniversaire de la Fédération Européenne Serruriers.

ES Una convención de gran éxito en la que Silca participó como expositor y Silver Sponsor y que fue la ocasión para celebrar el trigésimo aniversario de la Federación Europea de Cerrajeros.

PT Uma convenção muito bem sucedida em que Silca participou como expositor e Silver Sponsor e essa foi a oportunidade para celebrar o 30º aniversário da Federação Europeia Serralheiros.

Facts and Figures / Fatti e Cifre / Zahlen und Fakten / Faits et Chiffres / Datos y Cifras / Fatos e Números

24

represented locksmith associations / associazioni di settore rappresentate / vertrete Schlosserverbände / associations de serruriers représentées / asociaciones de cerrajeros representadas / associações de serralheiros representadas

1900

registered visitors, a third of whom foreigners / visitatori registrati, un terzo dei quali stranieri / registrierte Besucher, ein Drittel von ihnen Ausländer / visiteurs inscrits, dont un tiers étrangers / visitantes registrados, un tercio de ellos extranjeros / visitantes registrados, um terço deles estrangeiros

170

training classes participants / partecipanti ai corsi a pagamento / Teilnehmer an den Schulungen / participants aux cours de formation / participantes en los cursos de formación / participantes dos cursos de formação

45

visitors' countries of origin / paesi di provenienza dei visitatori / Herkunftsländer der Besucher / pays d'origine des visiteurs / países de origen de los visitantes / países de origem dos visitantes

40

exhibitors / espositori / Aussteller / exposants / expositores / expositores

30

years of activity of ELF / anni di attività dell'ELF / Jahre von ELF Aktivität / années d'activité de ELF / años de actividad del ELF / anos de atividade da ELF

















Full ELF Convention 2014 photogallery on www.silca.biz

New Keys / Chiavi Nuove / Neue Schlüssel / Nouvelles Clés
Llaves Nuevas / Chaves Nuevas

FOR: PER:	CORBIN	KEYA	LEHEMANN	FOR / PER
	<p>CB104R</p>	<p>KEY2</p>	<p>MLM9</p> <p>MLM</p>	CORBIN (I) KEYA (E) LEHEMANN (D) MLM MLM (D) + LEHEMANN HUF (D) HYUNDAI (ROK) TOYOTA (J)
FOR: PER:	HUF	HYUNDAI	TOYOTA	
	<p>HU92RTE 1-8100</p> <p>Key with Adapter / without Transponder chip Chiave con Adattatore / senza Transponder chip Schlüssel mit Adapter / ohne Transponder chip Clé avec Adaptateur / sans Transponder chip Llaves con Adaptador / sin Transponder chip Chave com Adaptador / sem Transponder chip</p>	<p>HYN12TE A 1-1000</p> <p>HYN15TE WA 1001-3040</p> <p>Key with Adapter / without Transponder chip Chiave con Adattatore / senza Transponder chip Schlüssel mit Adapter / ohne Transponder chip Clé avec Adaptateur / sans Transponder chip Llaves con Adaptador / sin Transponder chip Chave com Adaptador / sem Transponder chip</p>	<p>TOY48BTE 40000-49999</p> <p>Key with Adapter / without Transponder chip Chiave con Adattatore / senza Transponder chip Schlüssel mit Adapter / ohne Transponder chip Clé avec Adaptateur / sans Transponder chip Llaves con Adaptador / sin Transponder chip Chave com Adaptador / sem Transponder chip</p>	
				01 COMMERCIAL GROUP GRUPPO COMMERCIALE PREISEGRUPPE GROUPE COMMERCIAL GRUPO COMMERCIAL GRUPO COMERCIAL www.silca.biz

Car Keys Guide / Guida Chiavi Auto / Marktführer für Autoschlüssel / Guide Clés pour Voitures
 Guía Llaves para Coches / Guia Chaves para Carros

New Updates

1	2	2a	3	3a	3b	E1+E2		6	42+71	72	43 44a	12	15	
						GTI COMPATIBLE		IGNITION 						
CAR MAKE MODEL	FROM	TO	SILCA REF.	SILCA REF.	SILCA REF.	COPY	GEN.	TRANSP. TYPE	FAST COPY PLUS RW4 PLUS FAST COPY / RW4	FAST COPY PLUS RW4 PLUS	FAST COPY RW4	STP		
														

For more info on the uses of car keys, refer to the Silca Electronic Key Catalogue:

















BMW®													
SERIE 1	2004	2011	HU92RMH	HU92RTE		Y		PH / CR2	46	Y	P-BOX		
SERIE 3	2005	2011	HU92RMH	HU92RTE		Y		PH / CR2	46	Y	P-BOX		
SERIE 5	2003	2010	HU92RMH	HU92RTE		Y		PH / CR2	46	Y	P-BOX		
SERIE 6	2004	2011	HU92RMH	HU92RTE		Y		PH / CR2	46	Y	P-BOX		
SERIE 7	2002	2008	HU92RMH	HU92RTE		Y		PH / CR2	46	Y	P-BOX		
X5	2004	2011	HU92RMH	HU92RTE		Y		PH / CR2	46	Y	P-BOX		
Z4	2006	2011	HU92RMH	HU92RTE		Y		PH / CR2	46	Y	P-BOX		
HONDA®													
CIVIC	2006	2014	HON66MH	HON66TE	HON66FH*	Y	Y	PH / CR2	46	Y	P-BOX		
CIVIC	2006	2014	HON66T14					PH / CR2	46				
CIVIC	2014							PH / CR3	49-1C				
CR-V	2007	2014	HON66MH	HON66TE	HON66FH*	Y	Y	PH / CR2	46	Y	P-BOX		
CR-V	2007	2014	HON66T14					PH / CR2	46				
CR-V	2014							PH / CR3	49-1C				
HYUNDAI®													
STAREX	1998	2006	HYN12MH	HYN12TE	HYN12FH*	Y	Y	TEXAS	4C	Y	P-BOX		
KIA®													
RIO	2006	2009	HYN15MH	HYN15TE	HYN15FH*	Y	Y	PH / CR2	46	Y	P-BOX		
LAND ROVER®													
RANGE ROVER	2003	2005	HU92RMH	HU92RTE		Y		PH / CR2	46	Y	P-BOX		
LEXUS®													
ALTEZZA [J]	1999		TOY48MH	TOY48BTE	TOY48FH*	Y	Y	TEXAS	4C	Y	P-BOX		
ES300	2002	2003	TOY48MH	TOY48BTE	TOY48FH*	Y	Y	TEXAS	4C	Y	P-BOX		
ES330	2004	2007	TOY48MH	TOY48BTE	TOY48FH*	Y		TEX / CR	68	Y	P-BOX		
GS/LS/LX	1998		TOY48MH	TOY48BTE	TOY48FH*	Y	Y	TEXAS	4C	Y	P-BOX		
GS300	1998	2005	TOY48MH	TOY48BTE	TOY48FH*	Y	Y	TEXAS	4C	Y	P-BOX		
GS300	2005	2007	TOY48MH	TOY48BTE	TOY48FH*	Y		TEX / CR	68	Y	P-BOX		
GS300/400 [J]	1998		TOY48MH	TOY48BTE	TOY48FH*	Y	Y	TEXAS	4C	Y	P-BOX		
GS400	1998	2001	TOY48MH	TOY48BTE	TOY48FH*	Y	Y	TEXAS	4C	Y	P-BOX		
GS430	2001	2005	TOY48MH	TOY48BTE	TOY48FH*	Y	Y	TEXAS	4C	Y	P-BOX		
GS430	2005	2007	TOY48MH	TOY48BTE	TOY48FH*	Y		TEX / CR	68	Y	P-BOX		
GX470	2003	2007	TOY48MH	TOY48BTE	TOY48FH*	Y		TEX / CR	68	Y	P-BOX		
IS200	1999	2005	TOY48MH	TOY48BTE	TOY48FH*	Y	Y	TEXAS	4C	Y	P-BOX		

* Blade for "Silca Flip key" plastic head

® are Registered Trademarks

Car Keys Guide / Guida Chiavi Auto / Marktführer für Autoschlüssel / Guide Clés pour Voitures
 Guía Llaves para Coches / Guia Chaves para Carros

New Updates

1	2	2a	3	3a	3b	E1+E2		6	42+71	72	43 44a	12	15
						GTI COMPATIBLE		IGNITION 					
CAR MAKE MODEL	FROM	TO	SILCA REF.	SILCA REF.	SILCA REF.	COPY	GEN.	TRANSP. TYPE	FAST COPY PLUS RW4 PLUS FAST COPY / RW4	FAST COPY PLUS RW4 PLUS	FAST COPY RW4	STP	
													

For more info on the uses of car keys, refer to the Silca Electronic Key Catalogue:



LEXUS®													
IS200	1999	2005	TOY48MH	TOY48BTE	TOY48FH*	Y	Y	TEXAS	4C	Y	P-BOX		
IS300	2001	2005	TOY48MH	TOY48BTE	TOY48FH*	Y	Y	TEXAS	4C	Y	P-BOX		
LS200	1999		TOY48MH	TOY48BTE	TOY48FH*	Y	Y	TEXAS	4C	Y	P-BOX		
LS400	1999	2003	TOY48MH	TOY48BTE	TOY48FH*	Y	Y	TEXAS	4C	Y	P-BOX		
LS430	2001	2006	TOY48MH	TOY48BTE	TOY48FH*	Y		TEX / CR	68	Y	P-BOX		
LX470	2001	2002	TOY48MH	TOY48BTE	TOY48FH*	Y	Y	TEXAS	4C	Y	P-BOX		
LX470	2003	2008	TOY48MH	TOY48BTE	TOY48FH*	Y		TEX / CR	68	Y	P-BOX		
RX300	1999	2003	TOY48MH	TOY48BTE	TOY48FH*	Y	Y	TEXAS	4C	Y	P-BOX		
RX330	2004	2009	TOY48MH	TOY48BTE	TOY48FH*	Y		TEX / CR	68	Y	P-BOX		
RX350	2004	2011	TOY48MH	TOY48BTE	TOY48FH*	Y		TEX / CR	68	Y	P-BOX		
RX400H	2005	2009	TOY48MH	TOY48BTE	TOY48FH*	Y		TEX / CR	68	Y	P-BOX		
RX450H	2010		TOY48MH	TOY48BTE	TOY48FH*	Y		TEX / CR	68	Y	P-BOX		
SC430	2002	2010	TOY48MH	TOY48BTE	TOY48FH*	Y		TEX / CR	68	Y	P-BOX		
NISSAN®													
NOTE	2006	2012	NSN14MH	NSN14TE	NSN14FH*	Y		PH / CR2	46	Y	P-BOX		
NOTE	2006	2012	SMART KEY					TEX / CR	XX				
NOTE	2006	2012						PH / CR2	46				
NOTE	2013							PH / CR3	49-1E				
QASHQAI	2007	2013	NSN14MH	NSN14TE	NSN14FH*	Y		PH / CR2	46	Y	P-BOX		
QASHQAI	2007	2013	SMART KEY					TEX / CR	XX				
QASHQAI	2007	2013						PH / CR2	46				
QASHQAI	2013							PH / CR3	49-1E				
RENAULT®													
CLIO IV	2012		SMART KEY					PH / CR3	49-1E				
RENAULT-DACIA®													
DUSTER	2013							PH / CR3	49-1E				
LOGAN	2013							PH / CR3	49-1E				
SANDERO	2013							PH / CR3	49-1E				
SYMBOL III	2013							PH / CR3	49-1E				
TOYOTA®													
LAND CRUISER 100	2000	2002	TOY48MH	TOY48BTE	TOY48FH*	Y	Y	TEXAS	4C	Y	P-BOX		
LAND CRUISER 100 (AUS)	2003		TOY48MH	TOY48BTE	TOY48FH*	Y		TEX / CR	60	Y	P-BOX		

* Blade for "Silca Flip key" plastic head

® are Registered Trademarks

Car Keys Guide / Guida Chiavi Auto / Marktführer für Autoschlüssel / Guide Clés pour Voitures
 Guía Llaves para Coches / Guia Chaves para Carros

New Updates

1	2	2a	3	3a	3b	E1+E2		6	42+71	72	43 44a	12	15
						GTI COMPATIBLE		IGNITION 					
CAR MAKE MODEL	FROM	TO	SILCA REF.	SILCA REF.	SILCA REF.	COPY	GEN.	TRANSP. TYPE	FAST COPY PLUS RW4 PLUS FAST COPY / RW4	FAST COPY PLUS RW4 PLUS	FAST COPY RW4	STP	
For more info on the uses of car keys, refer to the Silca Electronic Key Catalogue:													
TOYOTA-JAPAN®													
ARISTO	1998	2005	TOY48MH	TOY48BTE	TOY48FH*	Y	Y	TEXAS	4C	Y	P-BOX		
BREVIS	2001	2007	TOY48MH	TOY48BTE	TOY48FH*	Y	Y	TEXAS	4C	Y	P-BOX		
CELSIOR	1998	2004	TOY48MH	TOY48BTE	TOY48FH*	Y	Y	TEXAS	4C	Y	P-BOX		
CROWN	1999	2005	TOY48MH	TOY48BTE	TOY48FH*	Y	Y	TEXAS	4C	Y	P-BOX		
LAND CRUISER PRADO	2000	2002	TOY48MH	TOY48BTE	TOY48FH*	Y	Y	TEXAS	4C	Y	P-BOX		
ORIGIN	2000		TOY48MH	TOY48BTE	TOY48FH*	Y	Y	TEXAS	4C	Y	P-BOX		
PROGRÈS NC300	1998	2006	TOY48MH	TOY48BTE	TOY48FH*	Y	Y	TEXAS	4C	Y	P-BOX		
WINDOM	2001	2004	TOY48MH	TOY48BTE	TOY48FH*	Y	Y	TEXAS	4C	Y	P-BOX		

Motorcycle Keys Guide / Guida Chiavi Moto / Marktführer für Motorraderschlüssel
 Guide Clés pour Motocyclettes / Guía Llaves para Motocicletas / Guia Chaves para Motocicletas

New Updates

1	2	2a	3	3a	3b	E1+E2		6	42+71	72	43 44a	12	15
						GTI COMPATIBLE		IGNITION 					
MOTORCYCLE MAKE MODEL	FROM	TO	SILCA REF.	SILCA REF.	SILCA REF.	COPY	GEN.	TRANSP. TYPE	FAST COPY PLUS RW4 PLUS FAST COPY / RW4	FAST COPY PLUS RW4 PLUS	FAST COPY RW4	STP	
For more info on the uses of motorcycle keys, refer to the Silca Electronic Key Catalogue:													
KAWASAKI®													
ER-6	2006	2011	KW16CP										
ER-6	2012		KW14MH		KW14FH*	Y		TEX / CR	72	Y	P-BOX		

IMPORTANT NOTE: See also the "Vehicle Guide Legend" / Vedi anche la "Legenda Guida Veicoli" / Siehe auch die "Fahrzeugschlüssel Erläuterung" / Voir aussi la "Légende Guide Véhicules" / Véase también la "Leyenda Guía para Vehículos" / Veja também a "Legenda Guia para Veículos"

* Blade for "Silca Flip key" plastic head

® are Registered Trademarks

SILCA EMPTY SHELLS - NEW REFERENCES

 Silca Empty Shells: **3 new keys references** to widen the existing range.

 Silca Empty Shells: **3 nouvelles références** clés qui complètent la gamme existante.

 Silca Empty Shells: **3 nuove referenze** chiavi che implementano la gamma già esistente.

 Silca Empty Shells: **3 nuevas referencias** llaves que completan la gama existente.

 Silca Empty Shells: **3 Schlüssel Referenzen** die das bestehende Angebot implementieren.

 Silca Empty Shells: **3 novas referências** chaves que implementam a gama existente.

Brand	Part Number/Image	Application*/Utilization*	Models*				
			MODELS	YEAR FROM	YEAR TO	TRANSPONDER TYPE	TRP ID
TOYOTA® <small>(see also TOYOTA® JAPAN, TOYOTA® USA)</small>	TOY41RBR8 	3 Buttons	ECHO	2008	2005	TEXAS	4C
			MR2	2006	2007	TEXAS	4C
			YARIS	2006	2005	TEXAS	4C
TOYOTA®	TOY47BR82 	2 Buttons	AVENSIS	1998	2000	TEXAS	4C
			AVENSIS	2000	2003	TEX / CR	60
			AVENSIS	2003	2006	TEX / CR	70
			CARINA	1996	2000	TEXAS	4C
			COROLLA	1999	2006	TEXAS	4C
			YARIS	1999	2005	TEXAS	4C
TOYOTA®	TOY47BR88 	3 Buttons	AVENSIS	1998	2000	TEXAS	4C
			AVENSIS	2000	2003	TEX / CR	60
			AVENSIS	2003	2006	TEX / CR	70
			CARINA	1996	2000	TEXAS	4C
			COROLLA	1999	2006	TEXAS	4C
			YARIS	1999	2005	TEXAS	4C

* The uses of the keys are purely indicative and may be subject to updates and revisions. / Gli utilizzi delle chiavi sono da considerarsi puramente indicativi e possono essere oggetto di aggiornamenti e revisioni. / Die Abbildung und technischen Daten der Schlüssel sind nicht bindend. Silca behält sich Änderungen am Produkt, die zur Verbesserung beitragen, vor. / Les usages des clés sont purement indicatifs; ils peuvent être mis à jour et revus. / Los usos de las llaves deben considerarse puramente indicativos y pueden ser objeto de actualizaciones y revisiones. / As utilizações das chaves devem ser consideradas puramente indicativas e podem ser objecto de actualizações e revisões.

© Registered Trademarks. / © Marchi Registrati. / © Eingetragene Marken. / © Marques Déposées. / © Marcas Registradas. / © Marcas Registradas.

<p>TOYOTA® JAPAN (see also TOYOTA® USA, TOYOTA®)</p>	<p>TOY41RBRS8</p> 	<p>3 Buttons</p>	<table border="1"> <thead> <tr> <th>MODELS</th> <th>YEAR FROM</th> <th>YEAR TO</th> <th>TRANSPONDER TYPE</th> <th>TRP ID</th> </tr> </thead> <tbody> <tr> <td>PLATZ</td> <td>1999</td> <td>2002</td> <td>TEXAS</td> <td>4C</td> </tr> </tbody> </table>	MODELS	YEAR FROM	YEAR TO	TRANSPONDER TYPE	TRP ID	PLATZ	1999	2002	TEXAS	4C
MODELS	YEAR FROM	YEAR TO	TRANSPONDER TYPE	TRP ID									
PLATZ	1999	2002	TEXAS	4C									
<p>TOYOTA® USA (see also TOYOTA® JAPAN, TOYOTA®)</p>	<p>TOY41RBRS8</p> 	<p>3 Buttons</p>	<table border="1"> <thead> <tr> <th>MODELS</th> <th>YEAR FROM</th> <th>YEAR TO</th> <th>TRANSPONDER TYPE</th> <th>TRP ID</th> </tr> </thead> <tbody> <tr> <td>MR2</td> <td>2001</td> <td>2005</td> <td>TEXAS</td> <td>4C</td> </tr> </tbody> </table>	MODELS	YEAR FROM	YEAR TO	TRANSPONDER TYPE	TRP ID	MR2	2001	2005	TEXAS	4C
MODELS	YEAR FROM	YEAR TO	TRANSPONDER TYPE	TRP ID									
MR2	2001	2005	TEXAS	4C									

* The uses of the keys are purely indicative and may be subject to updates and revisions. / Gli utilizzi delle chiavi sono da considerarsi puramente indicativi e possono essere oggetto di aggiornamenti e revisioni. / Die Abbildung und technischen Daten der Schlüssel sind nicht bindend. Silca behält sich Änderungen am Produkt, die zur Verbesserung beitragen, vor. / Les usages des clés sont purement indicatifs; ils peuvent être mis à jour et revus. / Los usos de las llaves deben considerarse puramente indicativos y pueden ser objeto de actualizaciones y revisiones. / As utilizações das chaves devem ser consideradas puramente indicativas e podem ser objecto de actualizações e revisões.

© Registered Trademarks. / © Marchi Registrati. / © Eingetragene Marken. / © Marques Déposées. / © Marcas Registradas. / © Marcas Registradas.



**THE UPDATED EMPTY-SHELLS
CATALOGUE IS COMING SOON**

STAY TUNED ON WWW.SILCA.BIZ



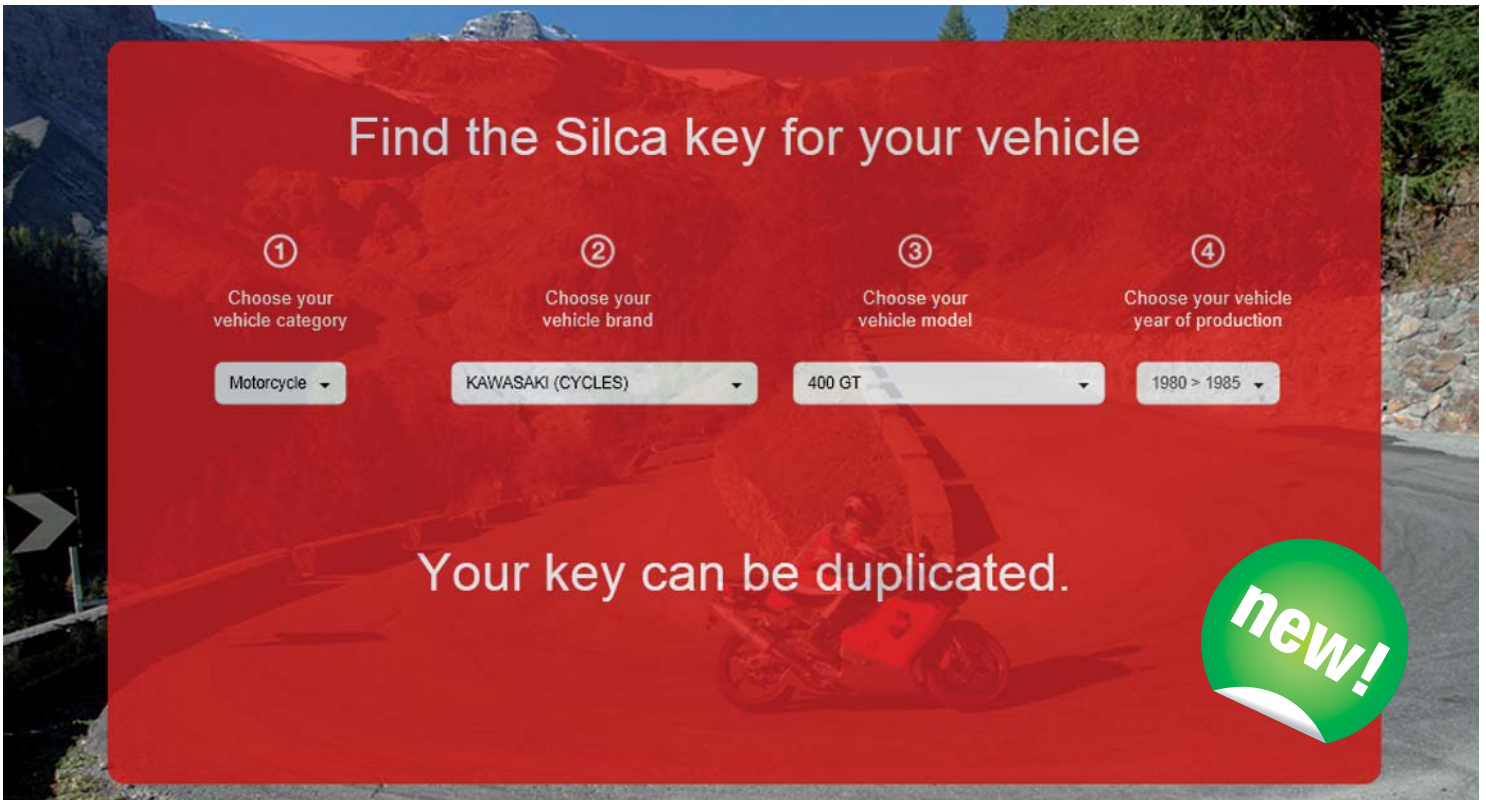

VEHICLE KEY FINDER

Silca's new app to assist your automotive keys service

🇬🇧 KICK START YOUR AUTOMOTIVE KEYS SERVICE WITH SILCA'S BRAND NEW APP

Silca has developed a brand new app to help you find out easily and rapidly if a vehicle key can be duplicated with Silca. You just have to enter vehicle type (car, motorcycle, truck), brand, model and year of fabrication and the application will tell you right away if Silca can provide you with a copy of the searched vehicle key or not.

The Silca Vehicle Key Finder is available also on smartphones: ekc.silca.biz/car-keys.

🇮🇹 METTI IN MOTO IL TUO SERVIZIO CHIAVI AUTOMOTIVE CON IL NUOVO APPLICATIVO SILCA

Silca ha sviluppato un nuovo applicativo che ti aiuterà a scoprire in modo semplice ed immediato se una chiave veicolo può essere duplicata con Silca. Selezionando semplicemente categoria del veicolo (auto, moto, camion), marca, modello e anno di produzione, l'applicazione è in grado di dire se Silca può fornirti la copia della chiave ricercata o meno.

Il Silca Vehicle Key Finder è disponibile anche su smartphone: ekc.silca.biz/car-keys.

🇩🇪 STARTEN SIE IHREN KFZ-SCHLÜSSEL-SERVICE MIT DEM SILCA AUTO TRANSPONDERSCHLÜSSEL-FINDER

Silca hat eine Lösung entwickelt, die Ihnen einfach und schnell hilft festzustellen, ob der Transponderschlüssel Ihres Fahrzeugs mit den Silca Transpondergeräten kopiert werden kann. Sie müssen nur Fahrzeugtyp (PKW, Motorrad, LKW), Marke, Modell und Baujahr auswählen und erfahren sofort, ob der Transponderschlüssel mit einem Silca Transpondergerät kopiert werden kann.

Der Silca Auto Transponderschlüssel-Finder ist auch mit einer für Smartphones optimierten Web-Oberfläche abrufbar: ekc.silca.biz/car-keys.



Discover it on www.silca.biz and ekc.silca.biz/car-keys

Find the Silca key for your vehicle

① Choose your vehicle category
Car

② Choose your vehicle brand
FORD USA

③ Choose your vehicle model
GT

④ Choose your vehicle year of production
2005 > 2006

Your key can be duplicated.
Your car immobilizer must be updated by a Silca specialist.



VEHICLE KEY FINDER

Silca's new app to assist your automotive keys service

■ DÉMARREZ VOTRE SERVICE CLÉS AUTOMOBILE AVEC LA NOUVELLE APP DE SILCA

Silca a développé une nouvelle application pour vous aider à découvrir facilement et rapidement si une clé de véhicule peut être reproduite avec Silca. En sélectionnant simplement la catégorie de véhicule (voiture, moto, camion), la marque, le modèle et l'année de production, l'application est capable de dire si Silca peut vous donner une copie de la clé recherchée ou pas.

Le Vehicle Key Finder de Silca est disponible aussi sur smartphones: ekc.silca.biz/car-keys.

■ ARRANQUE O SEU SERVIÇO DE CHAVES AUTOMOTIVE COM O NOVO APLICATIVO SILCA

Silca desenvolveu um novo aplicativo que irá ajudá-lo rápida e facilmente descobrir se uma chave para veículo pode ser duplicada com Silca. Simplesmente selecionando a categoria do veículo (carro, moto, caminhão), a marca, o modelo e o ano de produção, a aplicação é capaz de dizer se Silca pode dar-lhe uma cópia da chave procurada ou não.

O Silca Vehicle Key Finder também está disponível em seu smartphone: ekc.silca.biz/car-keys.

■ ARRANQUES TU SERVICIO LLAVES AUTOMOTIVE CON LA NUEVA APLICACIÓN DE SILCA

Silca ha desarrollado una nueva aplicación que te ayudará a averiguar rápidamente y fácilmente si una llave de vehículo se puede duplicar con Silca. Hay sólo que seleccionar la categoría del vehículo (coche, moto, camión), la marca, el modelo y el año de producción y la aplicación dirá si Silca puede proporcionarte una copia de la llave buscada.

El Silca Vehicle Key Finder está también disponible en smartphones: ekc.silca.biz/car-keys.



Discover it on www.silca.biz and ekc.silca.biz/car-keys

PER:
FOR: **SECUREMME (I)**

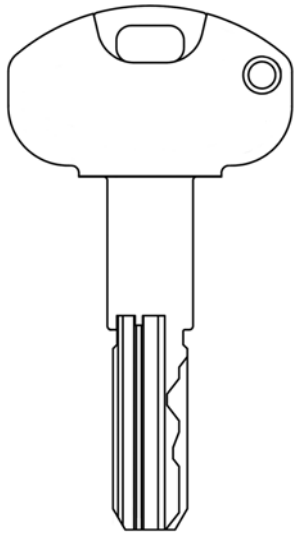

(K5)
6 pin



FUTURA



OPTIONAL



D744017ZB

18J Jaw
Ganascia 18J
18J Backe
Mâchoire 18J
Quijada 18J
Garra 18J

STANDARD



D943254ZR

02J Jaw
Ganascia 02J
02J Backe
Mâchoire 02J
Quijada 02J
Garra 02J

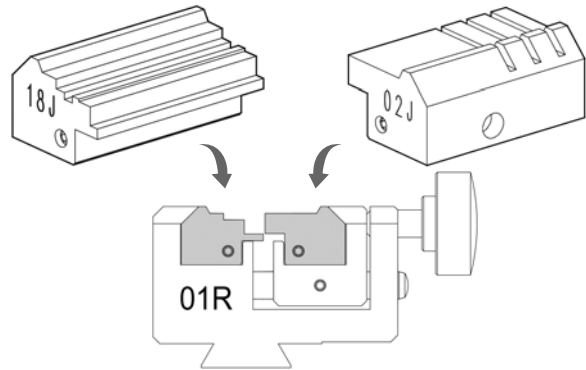

Delivery time AUGUST 2014
Disponibilità AGOSTO 2014
Lieferbar AUGUST 2014
Disponibilité AOÛT 2014
Disponibilidad AUGUSTO 2014
Disponibilidade AGOSTO 2014

OPTIONAL



D743673ZB

Cutter 02D
Fresa 02D
Fräser 02D
Fraise 02D
Fresa 02D
Fresa 02D

**System protected by a password issued by Silca on receipt of authorization.
Sistema protetto da password rilasciata da Silca a fronte di autorizzazione.
System geschützt durch von Silca geliefertes Passwort auf Genehmigung.
Système protégé par un password qui est émis par Silca sur autorisation.
Sistema protegido por password que expide Silca contra autorización.
Sistema protegido por uma password emitida por Silca contra a autorização.**

PER:
FOR:

AUDI (D)
FORD (D)
PORSCHE (D)
SEAT (E)
SKODA (CZ)
VOLKSWAGEN (D)

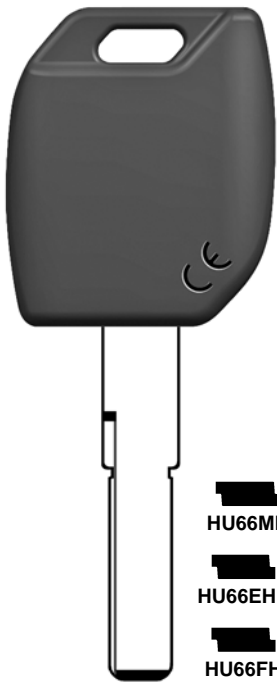

FUTURA

OPTIONAL



D743255ZB

03J Jaw
Ganascia 03J
03J Backe
Mâchoire 03J
Quijada 03J
Garra 03J

STANDARD



D943254ZR

02J Jaw
Ganascia 02J
02J Backe
Mâchoire 02J
Quijada 02J
Garra 02J

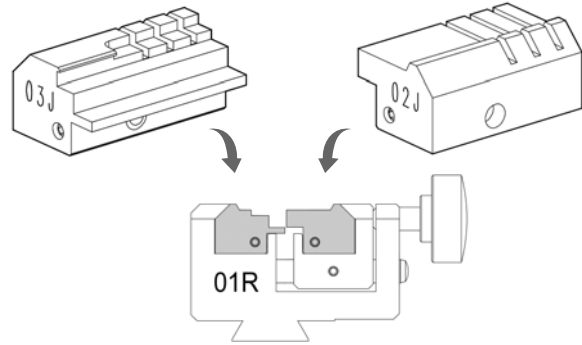

STANDARD



D742606ZB

Cutter 01L
Fresa 01L
Fräser 01L
Fraise 01L
Fresa 01L
Fresa 01L

OR



OPTIONAL



D744023ZB

19J Jaw
Ganascia 19J
19J Backe
Mâchoire 19J
Quijada 19J
Garra 19J

STANDARD



D943254ZR

02J Jaw
Ganascia 02J
02J Backe
Mâchoire 02J
Quijada 02J
Garra 02J

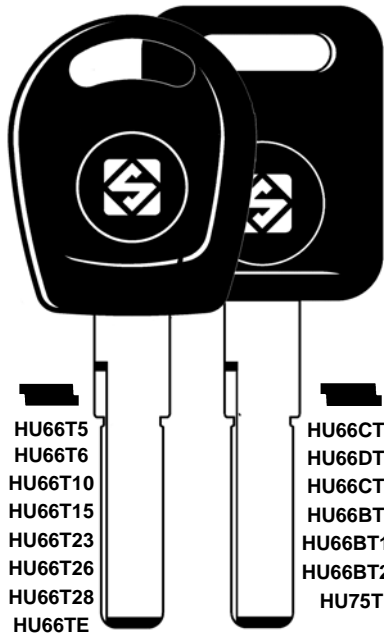

HU66P

HU66AT5
HU66AT6

HUF (D) - WITTE (D)

STANDARD



D742606ZB

Cutter 01L
Fresa 01L
Fräser 01L
Fraise 01L
Fresa 01L
Fresa 01L

Delivery time JULY 2014
Disponibilità LUGLIO 2014
Lieferbar JULI 2014
Disponibilité JUILLET 2014
Disponibilidad JULIO 2014
Disponibilidade JULHO 2014

PER:
FOR:

HUF (D)



FUTURA

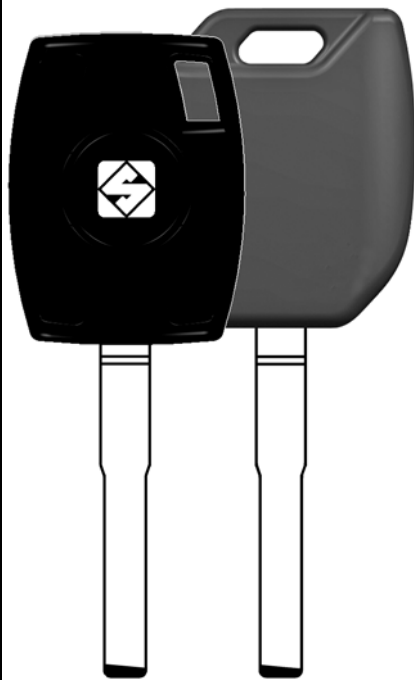

- HU101T17
- HU101T20
- HU101TE
- HU101MH
- HU101T
- HU101AP
- HU101EH
- HU101FH

OPTIONAL D743255ZB



- 03J Jaw
- Ganascia 03J
- 03J Backe
- Mâchoire 03J
- Quijada 03J
- Garra 03J



STANDARD D943254ZR



- 02J Jaw
- Ganascia 02J
- 02J Backe
- Mâchoire 02J
- Quijada 02J
- Garra 02J

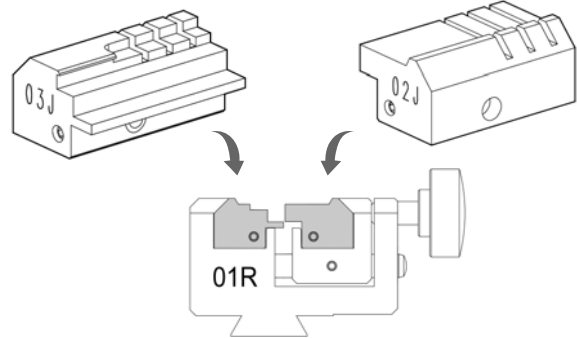

STANDARD



D742606ZB

- Cutter 01L
- Fresa 01L
- Fräser 01L
- Fraise 01L
- Fresa 01L
- Fresa 01L

OR



OPTIONAL D744023ZB



- 19J Jaw
- Ganascia 19J
- 19J Backe
- Mâchoire 19J
- Quijada 19J
- Garra 19J



STANDARD D943254ZR



- 02J Jaw
- Ganascia 02J
- 02J Backe
- Mâchoire 02J
- Quijada 02J
- Garra 02J

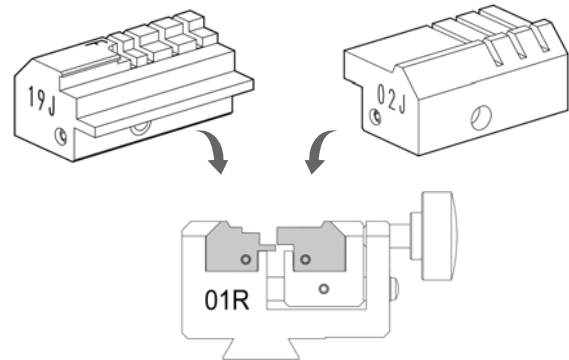

STANDARD



D742606ZB

- Cutter 01L
- Fresa 01L
- Fräser 01L
- Fraise 01L
- Fresa 01L
- Fresa 01L

Delivery time JULY 2014
 Disponibilità LUGLIO 2014
 Lieferbar JULI 2014
 Disponibilité JUILLET 2014
 Disponibilidad JULIO 2014
 Disponibilidade JULHO 2014

PER:
FOR:

FORD (D)

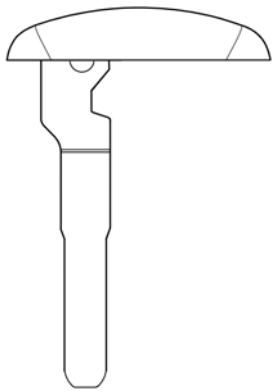

(Escape model)



FUTURA

OPTIONAL



D741485ZB

A34 adapter
Adattatore A34
Adapter A34
Adaptateur A34
Adaptador A34
Adaptador A34

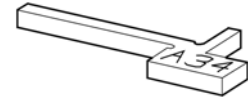

STANDARD



D943253ZR

01J Jaw
Ganascia 01J
01J Backe
Mâchoire 01J
Quijada 01J
Garra 01J



STANDARD



D943254ZR

02J Jaw
Ganascia 02J
02J Backe
Mâchoire 02J
Quijada 02J
Garra 02J

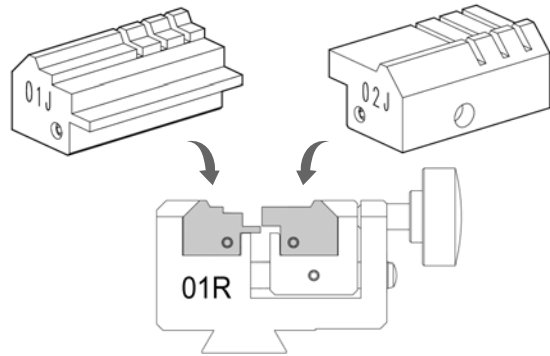

STANDARD



D742606ZB

Cutter 01L
Fresa 01L
Fräser 01L
Fraise 01L
Fresa 01L
Fresa 01L

OR



OPTIONAL



D744023ZB

19J Jaw
Ganascia 19J
19J Backe
Mâchoire 19J
Quijada 19J
Garra 19J



STANDARD



D943254ZR

02J Jaw
Ganascia 02J
02J Backe
Mâchoire 02J
Quijada 02J
Garra 02J

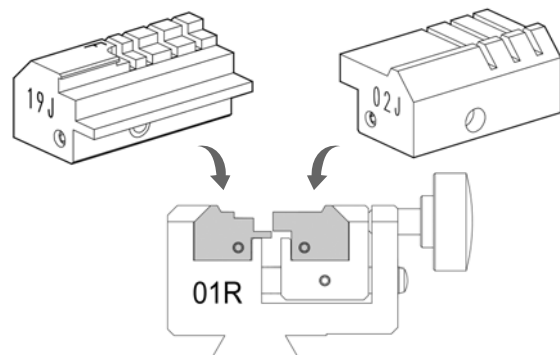

STANDARD





D742606ZB

Cutter 01L
Fresa 01L
Fräser 01L
Fraise 01L
Fresa 01L
Fresa 01L

Delivery time JULY 2014
Disponibilità LUGLIO 2014
Lieferbar JULI 2014
Disponibilité JUILLET 2014
Disponibilidad JULIO 2014
Disponibilidade JULHO 2014

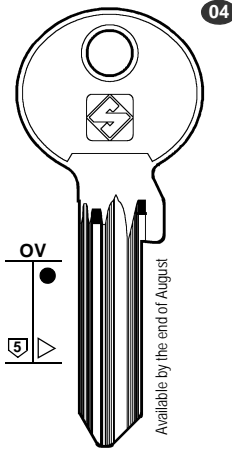
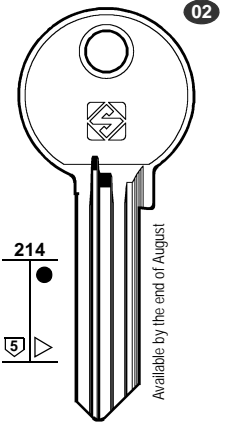
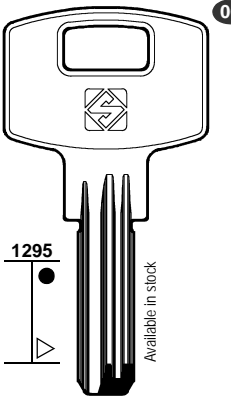
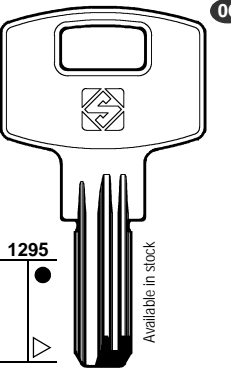
New Keys / Chiavi Nuove / Neue Schlüssel / Nouvelles Clés
Llaves Nuevas / Chaves Nuevas

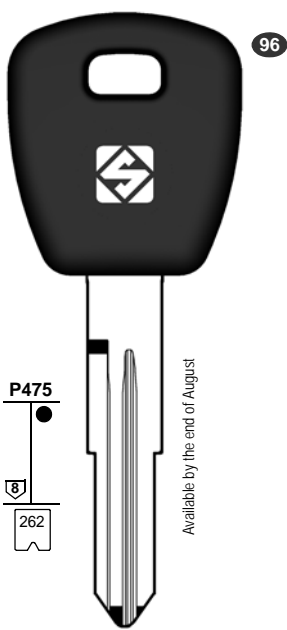
FOR: PER:	CISA	CORBIN	MASTER LOCK		FOR / PER
	 <p>04</p> <p>OV</p> <p>5</p> <p>Available by the end of August</p> <p>CS163X</p> <p>ABUS</p>	 <p>02</p> <p>214</p> <p>5</p> <p>Available by the end of August</p> <p>CB105R</p>	 <p>06</p> <p>1295</p> <p>5</p> <p>Available in stock</p> <p>MSL2</p>	 <p>06</p> <p>1295</p> <p>5</p> <p>Available in stock</p> <p>MSL3</p> 	<p>ABUS (I)</p> <p> CISA</p> <p>CISA (I)</p> <p>ABUS</p> <p>CORBIN (I)</p> <p>MASTER LOCK (RC)</p> <p>HONDA (J)</p>
FOR: PER:	HONDA				
	 <p>96</p> <p>P475</p> <p>5</p> <p>262</p> <p>Available by the end of August</p> <p>HON58RTE</p> <p>... 5001-8442</p> <p>Key with Adapter / without Transponder chip Chiave con Adattatore / senza Transponder chip Schlüssel mit Adapter / ohne Transponder chip Clé avec Adaptateur / sans Transpondeur chip Llaves con Adaptador / sin Transponder chip Chave com Adaptador / sem Transponder chip</p>				<p>01</p> <p>COMMERCIAL GROUP GRUPPO COMMERCIALE PREISEGRUPPE GROUPE COMMERCIAL GRUPO COMMERCIAL GRUPO COMERCIAL</p> <p>www.silca.biz</p>

Car Keys Guide / Guida Chiavi Auto / Marktführer für Autoschlüssel / Guide Clés pour Voitures
 Guía Llaves para Coches / Guia Chaves para Carros

New Updates

1	2	2a	3	3a	3b	E1+E2		6	42+71	72	43 44a	12	15
						GTI COMPATIBLE							
CAR MAKE MODEL	FROM	TO	SILCA REF.	SILCA REF.	SILCA REF.	COPY	GEN.	TRANSP. TYPE	FAST COPY PLUS RW4 PLUS FAST COPY / RW4	FAST COPY PLUS RW4 PLUS	FAST COPY RW4	STP	
For more info on the uses of car keys, refer to the Silca Electronic Key Catalogue:													
ACURA®													
RL	2005	2010	HON58RMH	HON58RTE	HON58RFH*	Y	Y	PH / CR2	46	Y	P-BOX		
TL	2004	2006	HON58RMH	HON58RTE	HON58RFH*	Y	Y	PH / CR2	46	Y	P-BOX		
TSX	2004	2007	HON58RMH	HON58RTE	HON58RFH*	Y	Y	PH / CR2	46	Y	P-BOX		

Motorcycle Keys Guide / Guida Chiavi Moto / Marktführer für Motorraderschlüssel
 Guide Clés pour Motocyclettes / Guía Llaves para Motocicletas / Guia Chaves para Motocicletas

New Updates

1	2	2a	3	3a	3b	E1+E2		6	42+71	72	43 44a	12	15
						GTI COMPATIBLE							
MOTORCYCLE MAKE MODEL	FROM	TO	SILCA REF.	SILCA REF.	SILCA REF.	COPY	GEN.	TRANSP. TYPE	FAST COPY PLUS RW4 PLUS FAST COPY / RW4	FAST COPY PLUS RW4 PLUS	FAST COPY RW4	STP	
For more info on the uses of motorcycle keys, refer to the Silca Electronic Key Catalogue:													
HONDA®													
GOLD WING	2001		HON58RMH	HON58RTE	HON58RFH*	Y	Y	PH / CR2	46	Y	P-BOX		



IMPORTANT NOTE:
 See also the "Vehicle Guide Legend"
 Vedi anche la "Legenda Guida Veicoli"
 Siehe auch die "Fahrzeugschlüssel Erläuterung"
 Voir aussi la "Légende Guide Véhicules"
 Véase también la "Leyenda Guía para Vehículos"
 Veja também a "Legenda Guia para Veículos"

* Blade for "Silca Flip key" plastic head

® are Registered Trademarks

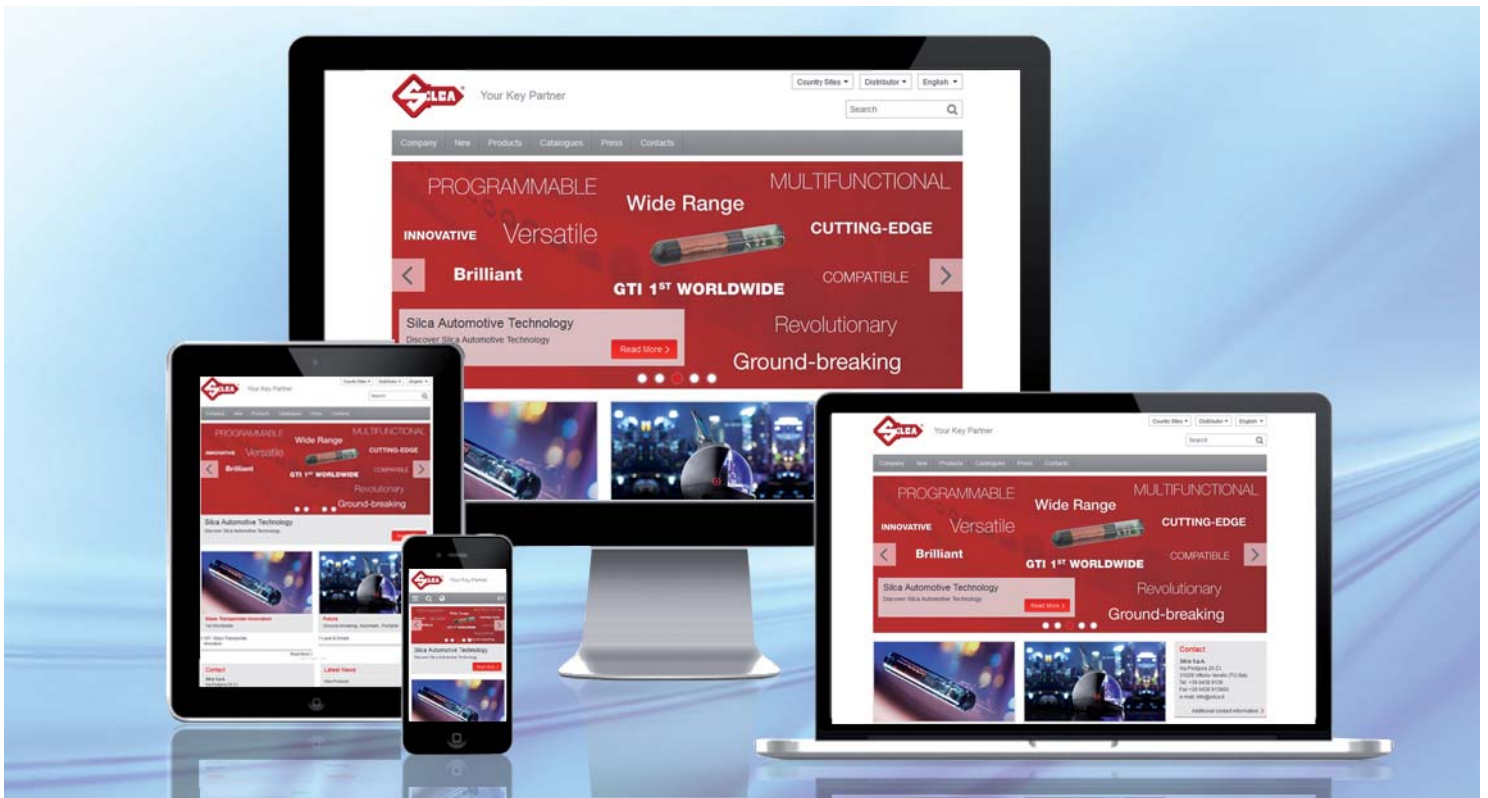

OPTIMIZED DESIGN ON ALL SILCA'S WEBSITES

SILCA'S WEBSITES HAVE BECOME RESPONSIVE

Silca's websites have now been optimized for tablets and smartphones to facilitate your navigation from any device.

The layout of the web pages changes according to the support you are using to improve your experience, while the overall look has become fresher and more orderly. Enjoy Silca's responsive websites now!

SILCAS WEBSITEN SIND RESPONSIVE GEWORDEN

Silcas Webseiten wurden für Tablets und Smartphones optimiert, um Ihr Navigation von jedem Gerät zu erleichtern.

Der grafische Aufbau der Website erfolgt anhand der Anforderungen des jeweiligen Gerätes, mit dem die Site betrachtet wird, um Ihre Benutzererfahrung zu verbessern, während das gesamte Layout ist frischer und ordentlicher geworden. Genießen Sie sofort die neuen Silca Webseiten!

LOS SITIOS SILCA SE VOLVIERON ADAPTABLES

Los sitios Silca se han optimizado para tabletas y teléfonos inteligentes para facilitar el uso con cualquier dispositivo.

El diseño de las páginas varía en función del medio utilizado, mientras que el diseño general se ha hecho más fresco y ordenado. Comience a navegar en los nuevos sitios Silca ahora!

I SITI SILCA SONO DIVENTATI RESPONSIVI

I siti Silca sono stati ottimizzati per tablet e smartphone così da facilitarne la fruizione da qualsiasi dispositivo.

Il layout delle pagine cambia secondo il supporto utilizzato per migliorarne l'esperienza d'uso, mentre l'impaginazione complessiva è stata resa più fresca e ordinata. Inizia a navigare nei nuovi siti Silca ora!

LES SITES SILCA SONT DEVENUS ADAPTATIFS

Les sites de Silca ont été optimisés pour tablettes et smartphones au fin d'en faciliter la consultation par n'importe quel appareil.

La mise en page des contenus diffère selon le support utilisé pour améliorer votre utilisation, tandis que le dessin d'ensemble a été rendu plus dynamique et ordonné. Commencez à naviguer dans les nouveaux sites Silca tout de suite!

OS SITES SILCA TORNARAM-SE RESPONSIVOS

Os sites de Silca foram otimizados para tablets e smartphones para facilitar a utilização com qualquer dispositivo.

O layout das páginas varia de acordo com o meio usado para melhorar a experiência do usuário, enquanto a paginação geral tornou-se mais fresca e arrumado. Comece a navegar os novos sites Silca agora!



THE UPDATED EMPTY SHELLS CATALOGUE IS NOW ONLINE



DISCOVER THE ENTIRE RANGE ON WWW.SILCA.BIZ AND EKC.SILCA.BIZ

EMPTY SHELLS CATALOGUE

🇬🇧 NEW EMPTY SHELLS CATALOGUE

- **Pocket size:** the July release of the Empty Shells Catalogue is in A5 format (148 x 210 mm) and is easier to consult and more practical to carry.
- **The entire Empty Shells range at hand:** all the 57 references and the relative vehicle applications are now easily accessible.
- **Always updated on EKC Web and Mobile:** the Empty Shells range has been integrated in the Silca Electronic Key Catalogue to facilitate its consultation both from your computer and from your smartphone.

🇩🇪 NEUER AUTOSCHLÜSSEL LEER-GEHÄUSE KATALOG

- **Taschenformat:** die Juli-Ausgabe des Autoschlüssel Leergehäusekatalogs ist im A5-Format (148x210mm), so dass er leichter durchzusehen und einfacher zu tragen ist.
- **Die gesamte Autoschlüssel Leergehäuse Palette auf der Hand:** alle 57 Referenzen und die relativen Fahrzeuganwendungen sind jetzt leicht zugänglich in diesem kompakten Katalog.
- **Immer im EKC Web und Mobile aktualisiert:** die Autoschlüssel Leergehäuse wurden in dem Silca Elektronischen Schlüsselkatalog integriert, um ihre Konsultation von Ihrem Computer und von Ihrem Smartphone zu erleichtern.

🇪🇸 NUEVO CÁLOGO EMPTY SHELLS

- **Formato de bolsillo:** la edición de julio del Catálogo de las Carcasas de Vehículo Silca es de tamaño A5 (148 x 210 mm), más fácil de consultar y más cómoda de llevar.
- **Toda la gama de Carcasas de Vehículo a la mano:** todas las 57 referencias con sus aplicaciones vehículo ahora fácilmente accesibles en este catálogo muy compacto.
- **Siempre actualizado en EKC Web y Móvil:** las Carcasas de Vehículo Silca se han integrado en el Catálogo Electrónico Llaves Silca para facilitar la consulta de la gama también a través de computadoras y teléfonos inteligentes.

🇮🇹 NUOVO CATALOGO EMPTY SHELLS

- **Formato tascabile:** l'uscita di Luglio del catalogo Empty Shells è in formato A5 (148 x 210 mm) per essere più facile da consultare e più pratica da portare.
- **L'intera gamma Empty Shells a portata di mano:** tutte le 57 referenze con le relative applicazioni veicolo saranno ora facilmente accessibili in questo catalogo formato compact.
- **Sempre aggiornato su EKC Web e Mobile:** la gamma Empty Shells è stata integrata nel Catalogo Elettronico Chiavi Silca per facilitarne la consultazione anche tramite computer e smartphone.

🇫🇷 NOUVEAU CATALOGUE EMPTY SHELLS

- **Format de poche:** l'édition de Juillet du Catalogue Empty Shells est en format A5 (148 x 210 mm) pour être plus facile à feuilleter et plus pratique à transporter.
- **Toute la gamme des Empty Shells à portée de main:** les 57 références avec leurs applications véhicule vont être facilement accessibles dans ce catalogue très compact.
- **Toujours à jour sur EKC Web et Mobile:** la gamme des Empty Shells a été intégrée dans le Catalogue Électronique Clés Silca pour en faciliter la consultation aussi par ordinateur et smartphone.

🇵🇹 NOVO CÁLOGO EMPTY SHELLS

- **Formato de bolso:** a edição de julho de Catálogo Empty Shells é de tamanho A5 (148 x 210 mm) para ser mais fácil de consultar e mais prática de chegar.
- **A gama inteira de Empty Shells à mão:** todas as 57 referências com suas aplicações veículo agora facilmente acessíveis neste catálogo muito compacto.
- **Sempre atualizado em EKC Web e Mobile:** a série Empty Shells foi integrada no Catálogo Electrónico Chaves Silca para facilitar a consulta da gama também através de computadores e de smartphones.



The Silca Empty Shells range will be continuously updated

ESSEN AND CHINA INTERNATIONAL SECURITY TRADE SHOWS

Silca is going to attend world's most important security exhibitions all around the world



UK Silca is going to attend the 2014 editions of Security Essen, the world's leading fair for security and fire prevention, and China International Hardware Show, Asia's top trade expo for the hardware and DIY sectors.

Come visit us and discover all the new products introduced this year on these prestigious occasions: state-of-the-art key cutting machines, ground-breaking automotive solutions and a brand new range of products dedicated to home, commercial and industrial safety and security.

IT Silca parteciperà alle edizioni 2014 di Security Essen, fiera di riferimento a livello mondiale sulla sicurezza e sulla protezione antincendio, e al China International Hardware Show, principale appuntamento espositivo in Asia per i settori ferramenta e bricolage.

Molte le novità che Silca introdurrà quest'anno: vieni a scoprire le innovative macchine duplicatrici, le soluzioni automotive all'avanguardia e i nuovi prodotti dedicati alla sicurezza residenziale, aziendale e commerciale presentati da Silca in queste prestigiose occasioni.

DE Silca wird an der Security Essen 2014, der weltweiten Messe für Sicherheit und Brandschutz, und an der China International Hardware Show 2014, der Top-Handelsmesse in Asien für die Eisenwaren und Heimwerken Branchen, teilnehmen.

Entdecken Sie die viele Neuheiten, die Silca bei diesen renommierten Veranstaltungen vorstellen wird: hochmoderne Schlüsselfräsmaschinen, bahnbrechende Lösungen für Fahrzeugschlüssel und eine neue Palette von Produkten für die Wohn-, Gewerbe- und Industriesicherheit.

FR Silca participera aux éditions 2014 de Security Essen, le salon mondial pour la sécurité et la prévention des incendies, et de China International Hardware Show, la foire plus importante de l'Asie pour les secteurs de la quincaillerie et du bricolage.

Venez découvrir les nombreuses nouveautés que Silca présentera cette année à ces prestigieux événements: des innovantes machines à tailler les clés, des solutions pour l'automobile d'avant-garde et des nouveaux produits pour la sécurité résidentielle, commerciale et corporative.

ES Silca participará en las ediciones 2014 de Security Essen, la feria mundial para la seguridad y la prevención contra incendios, y de China International Hardware Show, la principal feria de Asia para los sectores de ferretería y bricolaje.

Descubra las numerosas novedades que Silca expondrá este año en estas prestigiosas ocasiones: máquinas duplicadoras innovadoras, soluciones automotivo de vanguardia y nuevos productos para la seguridad residencial, corporativa y comercial.

PT Silca participará nas edições 2014 de Security Essen, feira mundial para a segurança ea prevenção de incêndios, e de China International Hardware Show, a mais importante feira da Ásia para os setores de ferragem e bricolagem.

Venha descobrir as muitas novidades que Silca apresentará este ano nestas ocasiões de prestígio: máquinas duplicadoras inovadoras, soluções automotivo de vanguardia e uma gama de novos produtos para a segurança residencial, empresarial e comercial.

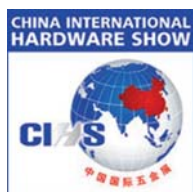

China International Hardware Show

Date: 18.09.2014 - 20.09.2014
Venue: Shanghai New International Expo Center
Booth: E3C46-E3C48
City: Shanghai, China
More info: www.hardwareshow-china.com







Security Essen

Date: 23.09.2014 - 26.09.2014
Venue: Essen Fair
Booth: Hall 12, Stand 208
City: Essen, Germany
More info: www.security-essen.de

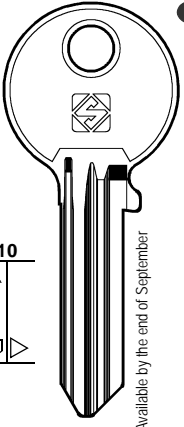
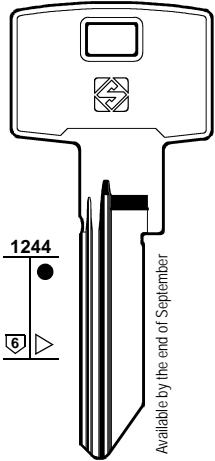
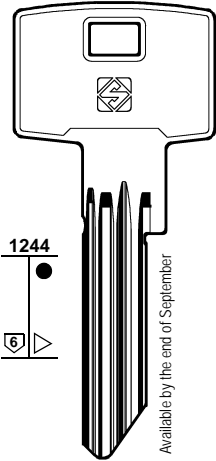

SAVE THE DATE!

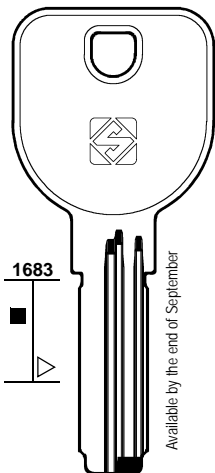
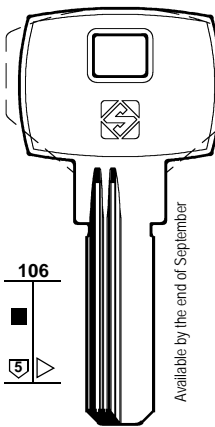
New Keys / Chiavi Nuove / Neue Schlüssel / Nouvelles Clés
Llaves Nuevas / Chaves Nuevas

FOR: PER:	CISA	PFAFFENHAIN	FOR / PER
	<div style="display: flex; justify-content: space-around;"> <div style="text-align: center;">  <p>02</p> <p>Available by the end of September</p> <p>10</p> <p>5</p> <p>CS162</p> <p>ABUS</p> </div> <div style="text-align: center;">  <p>05</p> <p>1244</p> <p>6</p> <p>Available by the end of September</p> <p>PHF26</p> </div> <div style="text-align: center;">  <p>05</p> <p>1244</p> <p>6</p> <p>Available by the end of September</p> <p>PHF26R</p> </div> <div style="text-align: center;">  <p>PHF27</p> </div> <div style="text-align: center;">  <p>PHF27R</p> </div> </div>	<p>ABUS (I) CISA</p> <p>CISA (I) ABUS</p> <p>PFAFFENHAIN (D)</p> <p>VACHETTE (F)</p>	
<p>FOR: PER:</p>	<h2>VACHETTE</h2>		<div style="text-align: center;">  <p>06</p> <p>1683</p> <p>5</p> <p>Available by the end of September</p> <p>VAC152</p> </div> <div style="text-align: center;">  <p>06</p> <p>106</p> <p>5</p> <p>Available by the end of September</p> <p>VAC153R</p> </div> <div style="text-align: center; margin-top: 20px;">  </div>

01
COMMERCIAL GROUP
GRUPPO COMMERCIALE
PREISEGRUPPE
GROUPE COMMERCIAL
GRUPO COMMERCIAL
GRUPO COMERCIAL

www.silca.biz

FOR / PER
HUF (D)
NEIMAN (D) (F)
PROTON (MAL)

FOR: HUF
PER:

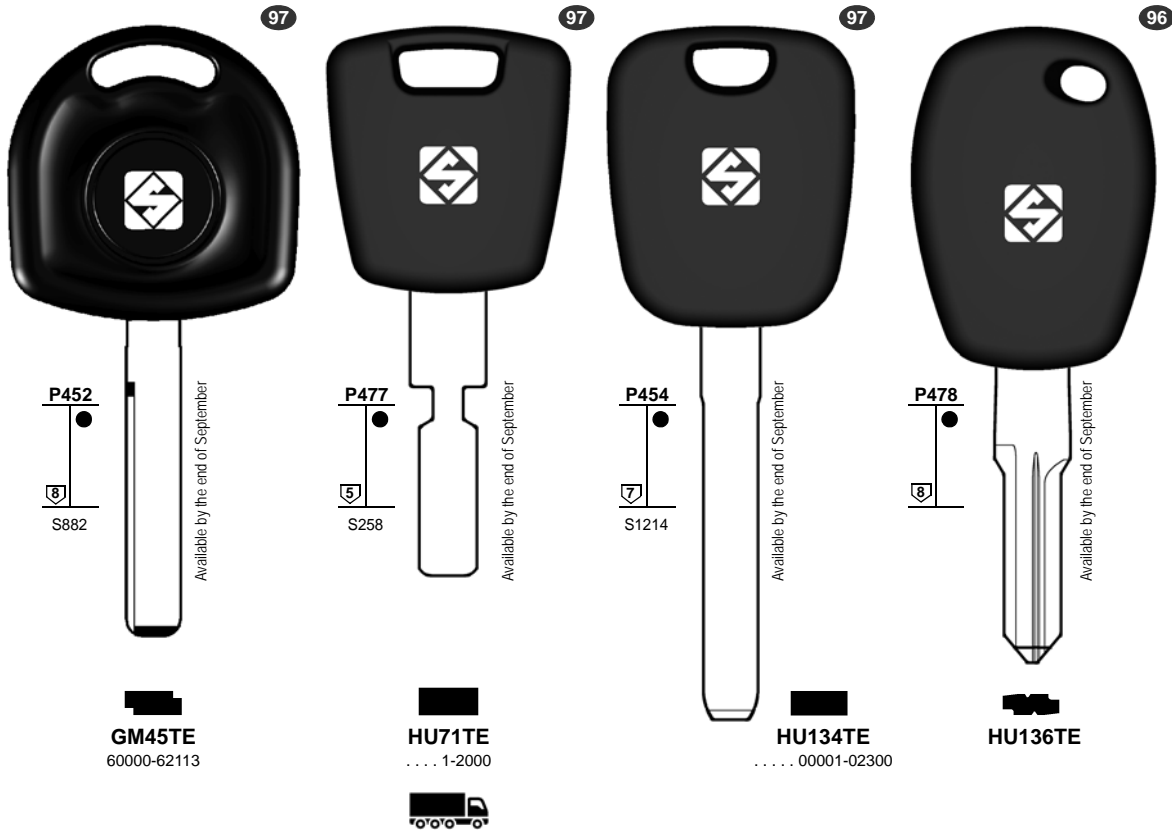

GM45TE
60000-62113

HU71TE
... 1-2000

HU134TE
... 00001-02300

HU136TE

Key with Adapter / without Transponder chip
Chiave con Adattatore / senza Transponder chip
 Schlüssel mit Adapter / ohne Transponder chip
Clé avec Adaptateur / sans Transpondeur chip
 Llaves con Adaptador / sin Transponder chip
Chave com Adaptador / sem Transponder chip

Key with Adapter / without Transponder chip
Chiave con Adattatore / senza Transponder chip
 Schlüssel mit Adapter / ohne Transponder chip
Clé avec Adaptateur / sans Transpondeur chip
 Llaves con Adaptador / sin Transponder chip
Chave com Adaptador / sem Transponder chip

FOR: NEIMAN
PER:

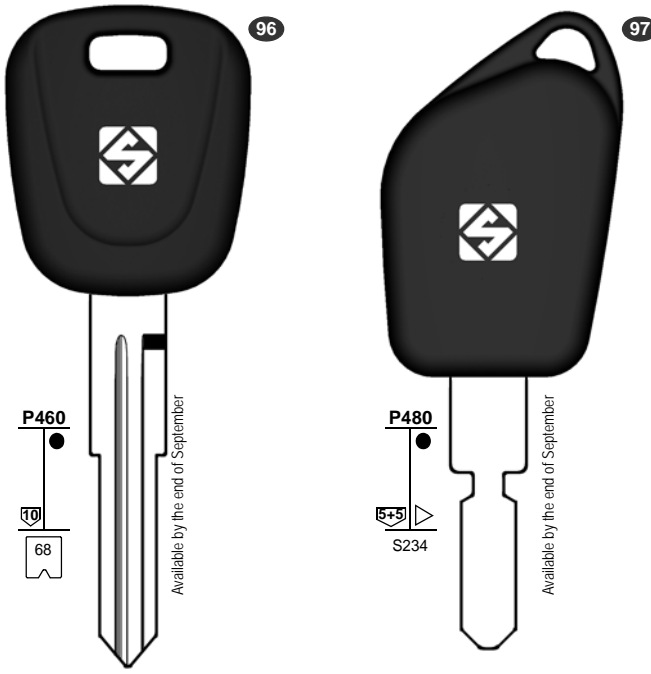

NE75TE
L ... 9001-10000

NE78TE
... 0123456789ABCDEF

Key with Adapter / without Transponder chip
Chiave con Adattatore / senza Transponder chip
 Schlüssel mit Adapter / ohne Transponder chip
Clé avec Adaptateur / sans Transpondeur chip
 Llaves Adaptador / sin Transponder chip
Chave com Adaptador / sem Transponder chip

FOR: PROTON
PER:

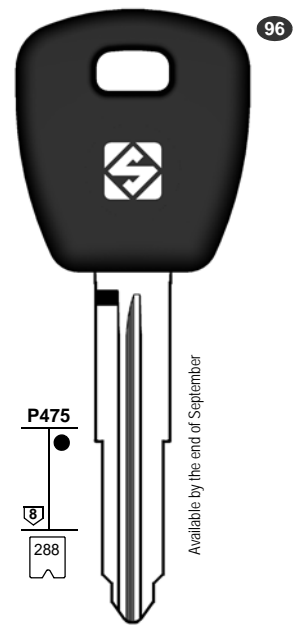

PO1RTE
... 30010-32009

Key with Adapter / without Transponder chip
Chiave con Adattatore / senza Transponder chip
 Schlüssel mit Adapter / ohne Transponder chip
Clé avec Adaptateur / sans Transpondeur chip
 Llaves con Adaptador / sin Transponder chip
Chave com Adaptador / sem Transponder chip

01
 COMMERCIAL GROUP
 GRUPPO COMMERCIALE
 PREISEGRUPPE
 GROUPE COMMERCIAL
 GRUPO COMMERCIAL
 GRUPO COMERCIAL

www.silca.biz

FOR:
PER:

SUBARU

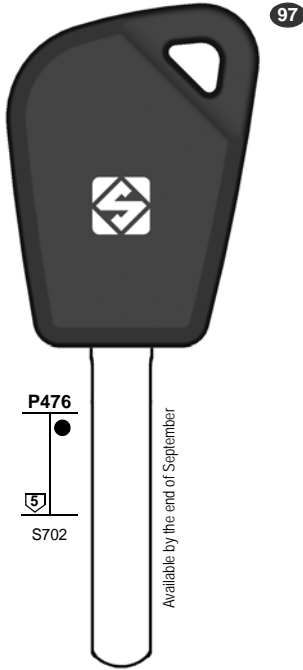

DAT17TE
T 1-3000

Key with Adapter / without Transponder chip
Chiave con Adattatore / senza Transponder chip
 Schlüssel mit Adapter / ohne Transponder chip
Clé avec Adaptateur / sans Transpondeur chip
 Llaves con Adaptador / sin Transponder chip
Chave com Adaptador / sem Transponder chip

SUZUKI

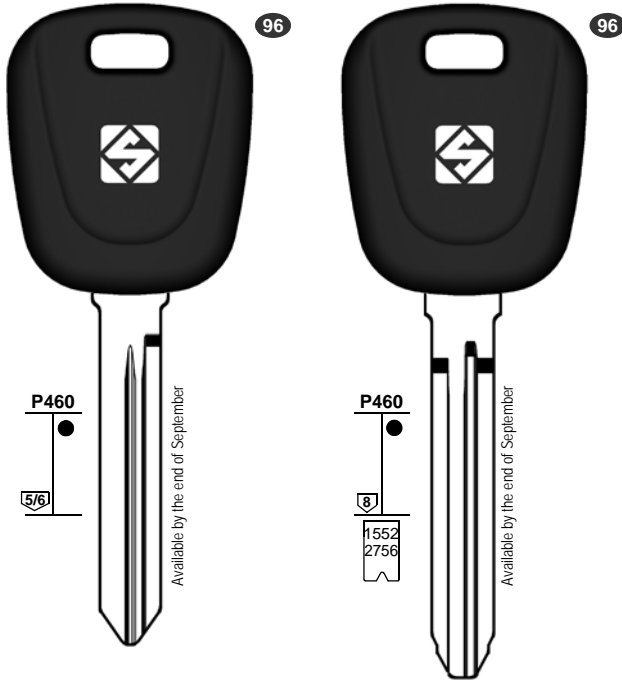

SZ18TE

SZ18RTE

SZ22TE

. 25001-26200

Key with Adapter / without Transponder chip
Chiave con Adattatore / senza Transponder chip
 Schlüssel mit Adapter / ohne Transponder chip
Clé avec Adaptateur / sans Transpondeur chip
 Llaves con Adaptador / sin Transponder chip
Chave com Adaptador / sem Transponder chip

FOR / PER

SUBARU (J)

SUZUKI (IND) (J)

TATA (IND)

TOYOTA (J)

FOR:
PER:

TATA

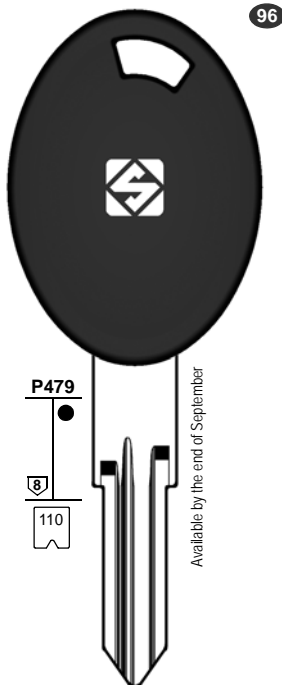

TAT1TE
S 1-5200

Key with Adapter / without Transponder chip
Chiave con Adattatore / senza Transponder chip
 Schlüssel mit Adapter / ohne Transponder chip
Clé avec Adaptateur / sans Transpondeur chip
 Llaves con Adaptador / sin Transponder chip
Chave com Adaptador / sem Transponder chip

TOYOTA

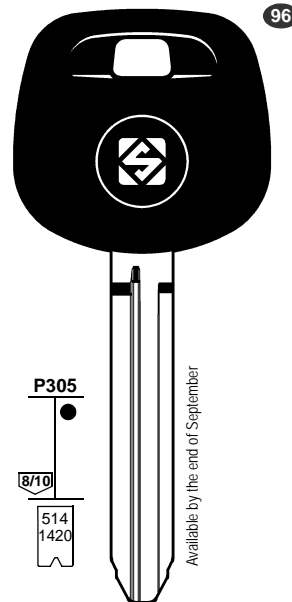

















TOY43RATE
. 10001-15000
. 70000-75928

Key with Adapter / without Transponder chip
Chiave con Adattatore / senza Transponder chip
 Schlüssel mit Adapter / ohne Transponder chip
Clé avec Adaptateur / sans Transpondeur chip
 Llaves con Adaptador / sin Transponder chip
Chave com Adaptador / sem Transponder chip

01

COMMERCIAL GROUP
 GRUPPO COMMERCIALE
 PREISGRUPPE
 GROUPE COMMERCIAL
 GRUPO COMMERCIAL
 GRUPO COMERCIAL

www.silca.biz

















1	2	2a	3	3a	3b	E1+E2		6	42+71	72	43 44a	12	15
						GTI COMPATIBLE							
CAR MAKE MODEL	FROM	TO	SILCA REF.	SILCA REF.	SILCA REF.	COPY	GEN.	TRANSP. TYPE	FAST COPY PLUS RW4 PLUS FAST COPY / RW4	FAST COPY PLUS RW4 PLUS	FAST COPY RW4	STP	
													
For more info on the uses of car keys, refer to the Silca Electronic Key Catalogue: 													
CHEVROLET® USA													
CAPRICE PPV	2011	2013	GM45MH	GM45TE	GM45FH*	Y		PH / CR2	46	Y	P-BOX		
CITROËN®													
C4 PICASSO	2006	2013	HU83BRS8					PH / CR2	46				
C5	2008		HU83BRS8					PH / CR2	46				
C6	2005	2012	HU83ARS2					PH / CR2	46				
C8	2006		HU83BRS8					PH / CR2	46				
JUMPY	2007		HU83ARS2					PH / CR2	46				
HOLDEN®													
COLORADO	2008		TOY43RMH	TOY43RATE	TOY43RFH*	Y	Y	PH / CR2	46	Y	P-BOX		
COMMODORE VE	2006		GM45MH	GM45TE	GM45FH*	Y		PH / CR2	46	Y	P-BOX		
HONDA®													
CITY	2014							PH / CR3	49-1C				
ISUZU®													
D-MAX	2007		TOY43RMH	TOY43RATE	TOY43RFH*	Y	Y	PH / CR2	46	Y	P-BOX		
KIA®													
VENGA	2010		HU134MH	HU134TE	HU134FH*	Y	Y	PH / CR2	46	Y	P-BOX		
LANCIA®													
PHEDRA	2006	2010	HU83BRS8					PH / CR2	46				
LAND ROVER®													
FREELANDER	2003	2006	NE75MH	NE75TE	NE75FH*	Y		PH / CR2	46	Y	P-BOX		
MARUTI SUZUKI®													
800	2007	2010	SZ18MH	SZ18TE	SZ18FH*	Y	Y	TEX / CR	65	Y	P-BOX		
ESTEEM	2007		SZ18RMH	SZ18RTE	SZ18RFH*	Y	Y	TEX / CR	65	Y	P-BOX		
OMNI	2007	2010	SZ18RMH	SZ18RTE	SZ18RFH*	Y	Y	TEX / CR	65	Y	P-BOX		
MASERATI®													
COUPE	2003	2007	SIP16MH	SIP16TE	SIP16FH*	Y		PH / CR2	46	Y	P-BOX		
PEUGEOT®													
207	2006		HU83ARS2					PH / CR2	46				
307	2001	2009	HU83ARS2					PH / CR2	46				
308	2007	2013	HU83BRS8					PH / CR2	46				
406	2002	2004	NE78MH	NE78TE		Y	Y	PH / CR2	46	Y	P-BOX		
607	2004	2010	NE78MH	NE78TE		Y	Y	PH / CR2	46	Y	P-BOX		
807	2006	2014	HU83BRS8					PH / CR2	46				

* Blade for "Silca Flip key" plastic head

® are Registered Trademarks

Car Keys Guide / Guida Chiavi Auto / Marktführer für Autoschlüssel / Guide Clés pour Voitures
Guía Llaves para Coches / Guia Chaves para Carros

New Updates

















1	2	2a	3	3a	3b	E1+E2		6	42+71	72	43 44a	12	15
						GTI COMPATIBLE		IGNITION 					
CAR MAKE MODEL	FROM	TO	SILCA REF.	SILCA REF.	SILCA REF.	COPY	GEN.	TRANSP. TYPE	FAST COPY PLUS RW4 PLUS FAST COPY / RW4	FAST COPY PLUS RW4 PLUS	FAST COPY RW4	STP	
													
For more info on the uses of car keys, refer to the Silca Electronic Key Catalogue: 													
PEUGEOT®													
3008	2009		HU83ARS2					PH / CR2	46				
3008	2009		HU83ARS2N					PH / CR2	46				
3008	2009		HU83BRS8					PH / CR2	46				
5008	2009		HU83BRS8					PH / CR2	46				
EXPERT	2007		HU83ARS2					PH / CR2	46				
PONTIAC®													
G8	2008	2009	GM45MH	GM45TE	GM45FH*	Y		PH / CR2	46	Y	P-BOX		
PROTON®													
415	1996	1998	PO1RMH	PO1RTE	PO1RFH*	Y	Y	TEXAS	4C	Y	P-BOX		
416	1996	1998	PO1RMH	PO1RTE	PO1RFH*	Y	Y	TEXAS	4C	Y	P-BOX		
RENAULT®-DACIA®													
DOKKER	2012		HU136MH	HU136TE	HU136FH*	Y		PH / CR2	46	Y	P-BOX		
LODGY	2012		HU136MH	HU136TE	HU136FH*	Y		PH / CR2	46	Y	P-BOX		
SANDERO	2010	2013	HU136MH	HU136TE	HU136FH*	Y		PH / CR2	46	Y	P-BOX		
SUBARU®													
B9 TRIBECA	2007		DAT17MH	DAT17TE	DAT17FH*	Y	Y	TEX / CR	62	Y	P-BOX		
FORESTER	2008		DAT17MH	DAT17TE	DAT17FH*	Y	Y	TEX / CR	62	Y	P-BOX		
IMPREZA	2007		DAT17MH	DAT17TE	DAT17FH*	Y	Y	TEX / CR	62	Y	P-BOX		
LEGACY	2004		DAT17MH	DAT17TE	DAT17FH*	Y	Y	TEX / CR	60	Y	P-BOX		
LEGACY	2005		DAT17MH	DAT17TE	DAT17FH*	Y	Y	TEX / CR	62	Y	P-BOX		
OUTBACK	2003		DAT17MH	DAT17TE	DAT17FH*	Y	Y	TEX / CR	60	Y	P-BOX		
OUTBACK	2005		DAT17MH	DAT17TE	DAT17FH*	Y	Y	TEX / CR	62	Y	P-BOX		
SUZUKI®													
GRAND VITARA	2006	2008	SZ22MH	SZ22TE	SZ22FH*	Y		PH / CR2	46	Y	P-BOX		
LIANA	2001	2005	SZ22MH	SZ22TE	SZ22FH*	Y	Y	TEX / CR	65	Y	P-BOX		
LIANA	2006	2007	SZ22MH	SZ22TE	SZ22FH*	Y	Y	TEX / CR	66	Y	P-BOX		
SWIFT	2005		SZ22MH	SZ22TE	SZ22FH*	Y	Y	TEX / CR	66	Y	P-BOX		
TATA®													
ARIA	2010		TAT1MH	TAT1TE	TAT1FH*	Y	Y	PH / CR2	46	Y	P-BOX		
INDICA	2008		TAT1MH	TAT1TE	TAT1FH*	Y	Y	PH / CR2	46	Y	P-BOX		
INDIGO	2008		TAT1MH	TAT1TE	TAT1FH*	Y	Y	PH / CR2	46	Y	P-BOX		
MANZA	2009		TAT1MH	TAT1TE	TAT1FH*	Y	Y	PH / CR2	46	Y	P-BOX		

* Blade for "Silca Flip key" plastic head

® are Registered Trademarks

Motorcycle Keys Guide / Guida Chiavi Moto / Marktführer für Motorräderschlüssel
 Guide Clés pour Motocyclettes / Guía Llaves para Motocicletas / Guia Chaves para Motocicletas

New Updates

1	2	2a	3	3a	3b	E1+E2		6	42+71	72	43 44a	12	15
						GTI COMPATIBLE							
MOTORCYCLE MAKE MODEL	FROM	TO	SILCA REF.	SILCA REF.	SILCA REF.	COPY	GEN.	TRANSP. TYPE	FAST COPY PLUS RW4 PLUS FAST COPY / RW4	FAST COPY PLUS RW4 PLUS	FAST COPY RW4	STP	
													
For more info on the uses of motorcycle keys, refer to the Silca Electronic Key Catalogue: 													
SCANIA®													
164	2004		HU71MH	HU71TE	HU71FH*	Y		TEX / CR	60	Y	P-BOX		
R-SERIES	2005		HU71MH	HU71TE	HU71FH*	Y		TEX / CR	60	Y	P-BOX		



IMPORTANT NOTE:

See also the "Vehicle Guide Legend"
 Vedi anche la "Legenda Guida Veicoli"
 Siehe auch die "Fahrzeugschlüssel Erläuterung"
 Voir aussi la "Légende Guide Véhicules"
 Véase también la "Leyenda Guía para Vehículos"
 Veja também a "Legenda Guia para Veículos"

* Blade for "Silca Flip key" plastic head

® are Registered Trademarks

SILCA EMPTY SHELLS - NEW REFERENCES

 Silca Empty Shells: **2 new keys references** to widen the existing range.



 Silca Empty Shells: **2 nouvelles références** clés qui complètent la gamme existante.

 Silca Empty Shells: **2 nuove referenze** chiavi che implementano la gamma già esistente.

 Silca Empty Shells: **2 nuevas referencias** llaves que completan la gama existente.

 Silca Empty Shells: **2 Schlüssel Referenzen** die das bestehende Angebot implementieren.

 Silca Empty Shells: **2 novas referências** chaves que implementam a gama existente.

Brand	Reference/Image	Specification	Vehicle Models*																																																																
			MODELS	YEAR FROM	YEAR TO	TRANSPONDER TYPE	TRP ID																																																												
CITROËN® PEUGEOT®	HU83ARS2  Available by the end of September	2 Buttons - Flip	<table border="1"> <thead> <tr> <th>MODELS</th> <th>YEAR FROM</th> <th>YEAR TO</th> <th>TRANSPONDER TYPE</th> <th>TRP ID</th> </tr> </thead> <tbody> <tr> <td colspan="5">CITROËN®</td> </tr> <tr> <td>C6</td> <td>2005</td> <td>2012</td> <td>PH/CR2</td> <td>46</td> </tr> <tr> <td>JUMPY</td> <td>2007</td> <td></td> <td>PH/CR2</td> <td>46</td> </tr> <tr> <td colspan="5">PEUGEOT®</td> </tr> <tr> <td>207</td> <td>2006</td> <td></td> <td>PH/CR2</td> <td>46</td> </tr> <tr> <td>307</td> <td>2001</td> <td>2009</td> <td>PH/CR2</td> <td>46</td> </tr> <tr> <td>3008</td> <td>2009</td> <td></td> <td>PH/CR2</td> <td>46</td> </tr> <tr> <td>EXPERT</td> <td>2007</td> <td></td> <td>PH/CR2</td> <td>46</td> </tr> </tbody> </table>					MODELS	YEAR FROM	YEAR TO	TRANSPONDER TYPE	TRP ID	CITROËN®					C6	2005	2012	PH/CR2	46	JUMPY	2007		PH/CR2	46	PEUGEOT®					207	2006		PH/CR2	46	307	2001	2009	PH/CR2	46	3008	2009		PH/CR2	46	EXPERT	2007		PH/CR2	46															
			MODELS	YEAR FROM	YEAR TO	TRANSPONDER TYPE	TRP ID																																																												
CITROËN®																																																																			
C6	2005	2012	PH/CR2	46																																																															
JUMPY	2007		PH/CR2	46																																																															
PEUGEOT®																																																																			
207	2006		PH/CR2	46																																																															
307	2001	2009	PH/CR2	46																																																															
3008	2009		PH/CR2	46																																																															
EXPERT	2007		PH/CR2	46																																																															
CITROËN® LANCIA® PEUGEOT®	HU83BRS8  Available by the end of September	3 Buttons - Flip	<table border="1"> <thead> <tr> <th>MODELS</th> <th>YEAR FROM</th> <th>YEAR TO</th> <th>TRANSPONDER TYPE</th> <th>TRP ID</th> </tr> </thead> <tbody> <tr> <td colspan="5">CITROËN®</td> </tr> <tr> <td>C4 PICASSO</td> <td>2006</td> <td>2013</td> <td>PH/CR2</td> <td>46</td> </tr> <tr> <td>C5</td> <td>2008</td> <td></td> <td>PH/CR2</td> <td>46</td> </tr> <tr> <td>C8</td> <td>2006</td> <td></td> <td>PH/CR2</td> <td>46</td> </tr> <tr> <td colspan="5">LANCIA®</td> </tr> <tr> <td>PHEDRA</td> <td>2006</td> <td>2010</td> <td>PH/CR2</td> <td>46</td> </tr> <tr> <td colspan="5">PEUGEOT®</td> </tr> <tr> <td>308</td> <td>2007</td> <td>2013</td> <td>PH/CR2</td> <td>46</td> </tr> <tr> <td>807</td> <td>2006</td> <td>2014</td> <td>PH/CR2</td> <td>46</td> </tr> <tr> <td>3008</td> <td>2009</td> <td></td> <td>PH/CR2</td> <td>46</td> </tr> <tr> <td>5008</td> <td>2009</td> <td></td> <td>PH/CR2</td> <td>46</td> </tr> </tbody> </table>					MODELS	YEAR FROM	YEAR TO	TRANSPONDER TYPE	TRP ID	CITROËN®					C4 PICASSO	2006	2013	PH/CR2	46	C5	2008		PH/CR2	46	C8	2006		PH/CR2	46	LANCIA®					PHEDRA	2006	2010	PH/CR2	46	PEUGEOT®					308	2007	2013	PH/CR2	46	807	2006	2014	PH/CR2	46	3008	2009		PH/CR2	46	5008	2009		PH/CR2	46
			MODELS	YEAR FROM	YEAR TO	TRANSPONDER TYPE	TRP ID																																																												
CITROËN®																																																																			
C4 PICASSO	2006	2013	PH/CR2	46																																																															
C5	2008		PH/CR2	46																																																															
C8	2006		PH/CR2	46																																																															
LANCIA®																																																																			
PHEDRA	2006	2010	PH/CR2	46																																																															
PEUGEOT®																																																																			
308	2007	2013	PH/CR2	46																																																															
807	2006	2014	PH/CR2	46																																																															
3008	2009		PH/CR2	46																																																															
5008	2009		PH/CR2	46																																																															

* The uses of the keys are purely indicative and may be subject to updates and revisions. / Gli utilizzi delle chiavi sono da considerarsi puramente indicativi e possono essere oggetto di aggiornamenti e revisioni. / Die Abbildung und technischen Daten der Schlüssel sind nicht bindend. Silca behält sich Änderungen am Produkt, die zur Verbesserung beitragen, vor. / Les usages des clés sont purement indicatifs; ils peuvent être mis à jour et revus. / Los usos de las llaves deben considerarse puramente indicativos y pueden ser objeto de actualizaciones y revisiones. / As utilizações das chaves devem ser consideradas puramente indicativas e podem ser objecto de actualizações e revisões.





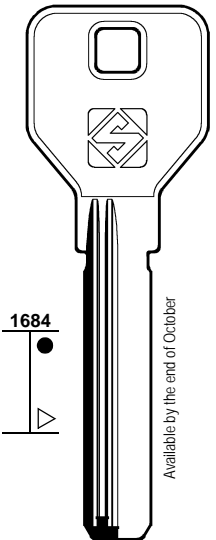
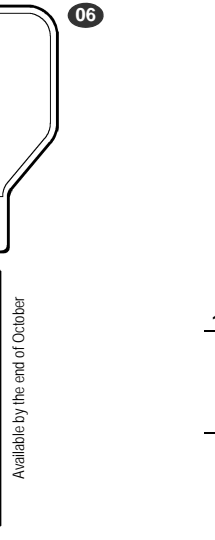
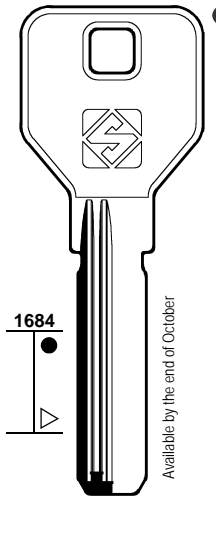
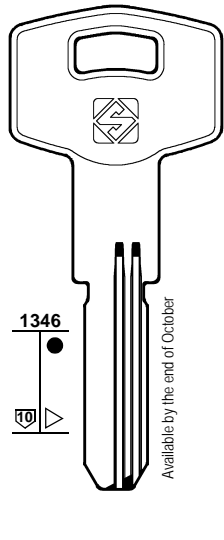
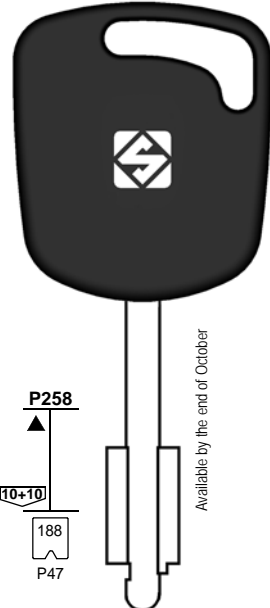
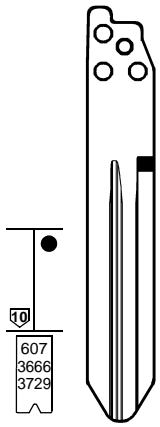
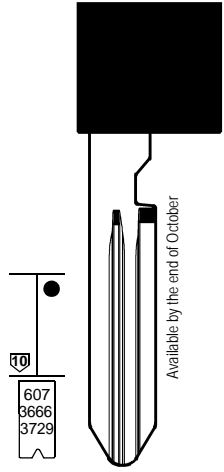











© Registered Trademarks. / © Marchi Registrati. / © Eingetragene Marken. / © Marques Déposées. / © Marcas Registradas. / © Marcas Registradas.

New Keys / Chiavi Nuove / Neue Schlüssel / Nouvelles Clés
Llaves Nuevas / Chaves Nuevas

FOR: PER:		CINA	KALE	FOR / PER
		 <p>1684 Available by the end of October</p> <p>RC8R</p>  <p>1684 Available by the end of October</p> <p>RC9R</p>  <p>1684 Available by the end of October</p> <p>RC10R</p> <p>BAODEAN MASTER LOCK - MSM</p> <p>BAODEAN - HOOPLY MASTER LOCK - MSM</p>	 <p>1346 Available by the end of October</p> <p>KLE11</p> <p>HOOPLY MASTER LOCK - MSM</p>	<p>BAODEAN (PRC) + CINA</p> <p>CINA (RC) BAODEN HOOPLY MASTER LOCK MSM</p> <p>HOOPLY (PRC) + CINA</p> <p>KALE (TR)</p> <p>MASTER LOCK (RC) + CINA</p> <p>MSM (PRC) + CINA</p>
		<p>FORD</p>  <p>P258 10+10 188 P47 Available by the end of October</p> <p>FO19TE C..... 12345</p>	<p>NISSAN</p>  <p>100 10 607 3666 3729 Available by the end of October</p> <p>NSN14TA 1-22185</p>  <p>100 10 607 3666 3729 Available by the end of October</p> <p>NSN14TBP 1-22185</p>	
				<p>FORD (EU)</p> <p>NISSAN (J)</p>
				<p>01 COMMERCIAL GROUP GRUPPO COMMERCIALE PREISEGRUPPE GROUPE COMMERCIAL GRUPO COMMERCIAL GRUPO COMERCIAL</p> <p>www.silca.biz</p>

Car Keys Guide / Guida Chiavi Auto / Marktführer für Autoschlüssel / Guide Clés pour Voitures
 Guía Llaves para Coches / Guia Chaves para Carros

New Updates

1	2	2a	3	3a	3b	E1+E2		6	42+71	72	43 44a	12	15
						GTI COMPATIBLE		IGNITION 					
CAR MAKE MODEL	FROM	TO	SILCA REF.	SILCA REF.	SILCA REF.	COPY	GEN.	TRANSP. TYPE	FAST COPY PLUS RW4 PLUS FAST COPY / RW4	FAST COPY PLUS RW4 PLUS	FAST COPY RW4	STP	
													
For more info on the uses of car keys, refer to the Silca Electronic Key Catalogue: 													
LDV®													
CONVOY	1998	2000	FO19MH	FO19TE	FO19FH*	Y	Y	TEXAS	4C	Y	P-BOX		
CUB	1998	2000	FO19MH	FO19TE	FO19FH*	Y	Y	TEXAS	4C	Y	P-BOX		
NISSAN®													
VARIOUS MODELS			NSN14TA										
VARIOUS MODELS			NSN14BP										



IMPORTANT NOTE:

See also the "Vehicle Guide Legend"
 Vedi anche la "Legenda Guida Veicoli"
 Siehe auch die "Fahrzeugschlüssel Erläuterung"
 Voir aussi la "Légende Guide Véhicules"
 Véase también la "Leyenda Guía para Vehículos"
 Veja também a "Legenda Guia para Veículos"

* Blade for "Silca Flip Key" plastic head

® are Registered Trademarks

Security Essen / Essen Fair, Germany

23-26 September 2014

Silca attended the 40th edition of the Security Essen fair, the world's leading exhibition for security and fire prevention, introducing innovative product solutions. These were the highlights.



AIR₄ RESIDENTIAL REMOTES

Silca's new line of residential remotes Air₄, suitable for barriers, garage doors and automated gates, was launched, garnering great interest from Silca customers and the attendees of the fair.

Able to store four different remotes in one device, Air₄ covers the most extensive range of remotes on the European market. Ergonomic, long-lasting and functional, it is set to meet the needs of both Silca partners and final customers. The first will benefit from its simple programming procedures, while the latter will appreciate its smart design, anatomical shape and splash-proof technology.

More info on www.silca.biz



News and photogallery on www.silca.biz

Security Essen / Essen Fair, Germany

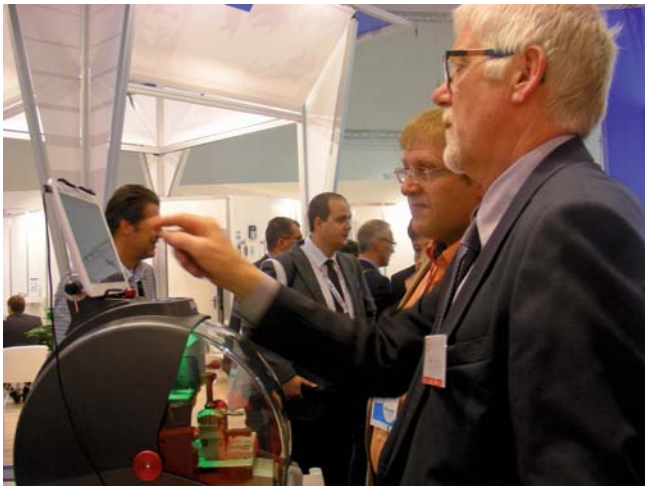

All the machines and devices exhibited at the stand were tried out first hand by customers and visitors interested in seeing how they work.

FUTURA AND FUTURA ONE

Futura keeps drawing the attention of specialists operating in the key cutting business. The unrivalled success of the latest tablet-integrated electronic key cutting machine from Silca at the Essen Security fair, where it played a leading role, is testament to that.

Building up on the successful launch of Futura less than a year ago, Silca presented as world premiere Futura One. Due to make its debut at the beginning of 2015, the new electronic machine is characterized by a single cutting station for laser and dimple keys: a customized solution to meet the needs of demanding and money-savvy customers.

PROFESSIONAL REVIEW OF FUTURA

“ Ilico has introduced the Silca branded “Futura” to their collection of fine key machines. Its innovative design and advanced electronics place it at the forefront of new key machine design. [...] capable of producing edge cut, laser cut, dimple, cruciform, tubular and Tibbe style keys, it is 12 machines (6 duplicators and 6 code cutters) in one amazingly small footprint. A first of its kind. ”

Robert Sieveking - The National Locksmith, Oct. 2014

PROTECH PLUS

ProTech Plus, the new highly performing semi-industrial machine for cutting, engraving and sorting different types of keys, ensures increased performances by 30% compared with the previous model, ProTech, guaranteeing the same flexibility and precision of results (up to +/- 0.03 mm tolerances). Silca has also engineered a special model of ProTech to cut Abloy® keys, the first worldwide semi-industrial cutting machine for this type of systems.



News and photogallery on www.silca.biz



SILCA KEY PROGRAMS WEB UPDATE



SILCA KEY PROGRAMS Web Update

www.silca.biz

SILCA KEY PROGRAMS - WEB Update

A new update of the SILCA KEY PROGRAMS software is available to all WEB subscribers. Check out the "News" section of Silca Key Programs on www.silca.biz to know more.

SILCA KEY PROGRAMS - Aggiornamento WEB

È disponibile un nuovo aggiornamento del software SILCA KEY PROGRAMS per tutti gli abbonati WEB. Consulta la sezione "Novità" di Silca Key Programs sul sito www.silca.biz per saperne di più.

SILCA KEY PROGRAMS - Aktualisierung WEB

Für alle WEB Abonnenten ist eine neue Aktualisierung von der Software SILCA KEY PROGRAMS verfügbar. Sehen Sie den Abschnitt "Neuheiten" von Silca Key Programs auf www.silca.biz, um weitere Informationen zu finden.

SILCA KEY PROGRAMS - Mise à jour WEB

Une nouvelle mise à jour du logiciel SILCA KEY PROGRAMS pour tous les abonnements WEB est disponible. Consultez la section "Nouveautés" de Silca Key Programs sur notre site www.silca.biz pour en savoir plus.

SILCA KEY PROGRAMS - Actualización WEB

Una nueva actualización del software SILCA KEY PROGRAMS para todos los abonados WEB está disponible. Visite la sección "Novedades" de Silca Key Programs en el sitio www.silca.biz para más informaciones.

SILCA KEY PROGRAMS - Atualização WEB

Nova atualização do software SILCA KEY PROGRAMS para todos o assinantes WEB está disponível. Consulte a seção "Novidades" de Silca Key Programs no site www.silca.biz para saber mais.

More info on www.silca.biz

NEW

FUTURA PROGRAMS - UPDATES

Futura Version 2.3.0

new series



Futura

Data update with new series / Aggiornamento dati con nuove serie
Datenaktualisierung mit neuen Serien / Mise à jour des données avec nouvelle
séries / Actualización datos con nuevas series / Atualização dados com novas séries

New items include/Tra le novità/Unter den Neuheiten/Parmi les nouveautés
Entre las novedades/Entre as novidades:

- Abus® (NW52;NW72)
- AGB® (5000)
- Ankerslot® (Infinity / Multi)
- Avocet® (Avocet ABS)
- Bajaj® (India Market)
- Basi® (CX6 Left)
- Corbin® (Evolution)
- Ces® (Ces WSM (5+5+6)
- Dom® (Dom® IX Emergency- Dom® IX Hochrippe (5+5+5)
- Gera® (WS; WSG; 2000 Plus)
- Gerda® (WKM3; WKM1)
- Guard® (Profile G11-G12-G13- G14-G17- EPS/P EP83)
- Esety® (Omega®)
- Hero Honda® (India Market)
- Hugo® (GR 2.55)
- Iseo® (CSR R9 Country N; Plus N)
- Kaba® (Kaba K6 (K6)- Kaba® K8 green (K8G) (4+4+4)- Kaba® K8S (K14)
- Kaba® (Titan; 8S-14 Mixed)
- Keso® (2000S;4000S)
- Lince® (C4;C2)
- Lob® (Lob Nefryt (5P)
- Mahindra® (India Market)
- Mauer® (MLS)
- Miwa® (Miwa® UR- Miwa® U9)
- Mottura® (Mottura C28 (5+4+4)-Mottura C30-C31 (5+4)
- Mul.T.Lock® (Mul.T.Lock® Interactive (115)- (115) MK- (206)- (215)-
(225)- (262)- (264)- Mul-T-Lock MT5
- Pfaffenhain® (Pfaffenhain® Wavy line)
- Tesa®
- Titan® (K66)
- Viro®
- Yale®

Check out the **"Futura"** page on the Silca site to know more.
Consulta il sito Silca alla **pagina "Futura"** per saperne di più.
Sehen Sie den **Seite "Futura"** auf Silca Website, um weitere Informationen zu finden.
Consultez la **page "Futura"** sur notre site Silca pour en savoir plus.
Visite la **página "Futura"** en el sitio Silca para más informaciones.
Consulte a **página "Futura"** no site Silca para saber mais.

New Keys / Chiavi Nuove / Neue Schlüssel / Nouvelles Clés
Llaves Nuevas / Chaves Nuevas

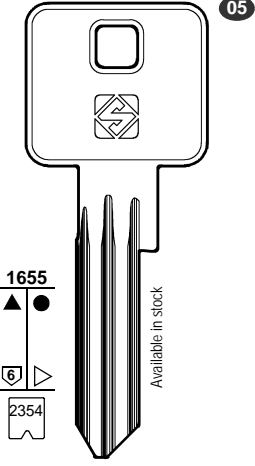
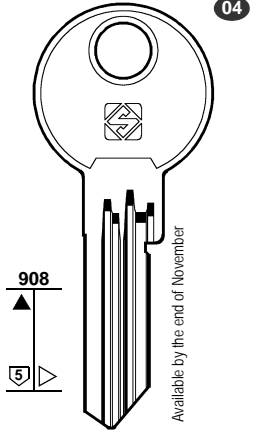
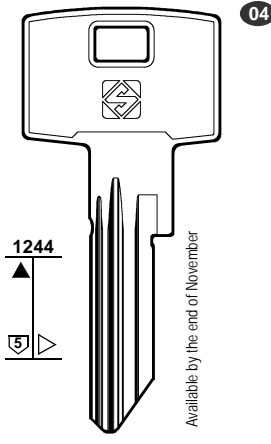
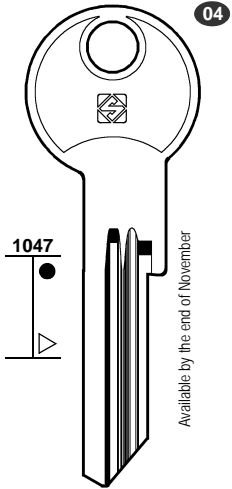
FOR: PER:	ABUS	FOR / PER	
	 <p>1655 ▲ ● 5 ▷ 2354</p> <p>Available in stock</p> <p>AB89 E60</p>	ABUS (D)	
	 <p>908 ▲ 5 ▷</p> <p>Available by the end of November</p> <p>BAB26R-18</p>	BAB (D)	
		PFAFFENHAIN (D)	
		YALE (GB)	
FOR: PER:	PFAFFENHAIN	YALE	
	 <p>1244 ▲ 5 ▷</p> <p>Available by the end of November</p> <p>PHF29 PHF28R</p>	 <p>1047 ● ▷</p> <p>Available by the end of November</p> <p>YA98R</p>	<p>01 COMMERCIAL GROUP GRUPPO COMMERCIALE PREISEGRUPPE GROUPE COMMERCIAL GRUPO COMMERCIAL GRUPO COMERCIAL</p> <p>www.silca.biz</p>

SILCA EMPTY SHELLS - NEW REFERENCES

 Silca Empty Shells: **9 new keys references** to widen the existing range.



 Silca Empty Shells: **9 nouvelles références** clés qui complètent la gamme existante.

 Silca Empty Shells: **9 nuove referenze** chiavi che implementano la gamma già esistente.

 Silca Empty Shells: **9 nuevas referencias** llaves que completan la gama existente.

 Silca Empty Shells: **9 Schlüssel Referenzen** die das bestehende Angebot implementieren.

 Silca Empty Shells: **9 novas referências** chaves que implementam a gama existente.

Brand	References/Image	Specifications	Vehicle Models*																																			
AUDI®	<p>HURSB2</p>  <p>Available in Stock</p>	2 Buttons	<table border="1"> <thead> <tr> <th>MODELS</th> <th>YEAR FROM</th> <th>YEAR TO</th> <th>TRANSPONDER TYPE</th> <th>TRP ID</th> </tr> </thead> <tbody> <tr> <td>A3</td> <td>1997</td> <td>2000</td> <td>MEG / CR</td> <td>48</td> </tr> <tr> <td>A4</td> <td>1995</td> <td>2001</td> <td>MEG / CR</td> <td>48</td> </tr> <tr> <td>A6</td> <td>1997</td> <td>2001</td> <td>MEG / CR</td> <td>48</td> </tr> </tbody> </table>	MODELS	YEAR FROM	YEAR TO	TRANSPONDER TYPE	TRP ID	A3	1997	2000	MEG / CR	48	A4	1995	2001	MEG / CR	48	A6	1997	2001	MEG / CR	48															
MODELS	YEAR FROM	YEAR TO	TRANSPONDER TYPE	TRP ID																																		
A3	1997	2000	MEG / CR	48																																		
A4	1995	2001	MEG / CR	48																																		
A6	1997	2001	MEG / CR	48																																		
AUDI®	<p>HURSB8</p>  <p>Available in Stock</p>	3 Buttons	<table border="1"> <thead> <tr> <th>MODELS</th> <th>YEAR FROM</th> <th>YEAR TO</th> <th>TRANSPONDER TYPE</th> <th>TRP ID</th> </tr> </thead> <tbody> <tr> <td>A2</td> <td>2000</td> <td>2005</td> <td>MEG / CR</td> <td>48</td> </tr> <tr> <td>A3</td> <td>1997</td> <td>2003</td> <td>MEG / CR</td> <td>48</td> </tr> <tr> <td>A4</td> <td>1999</td> <td>2005</td> <td>MEG / CR</td> <td>48</td> </tr> <tr> <td>A6</td> <td>1997</td> <td>2005</td> <td>MEG / CR</td> <td>48</td> </tr> <tr> <td>A8</td> <td>1994</td> <td>2003</td> <td>MEG / CR</td> <td>48</td> </tr> <tr> <td>TT</td> <td>1999</td> <td>2006</td> <td>MEG / CR</td> <td>48</td> </tr> </tbody> </table>	MODELS	YEAR FROM	YEAR TO	TRANSPONDER TYPE	TRP ID	A2	2000	2005	MEG / CR	48	A3	1997	2003	MEG / CR	48	A4	1999	2005	MEG / CR	48	A6	1997	2005	MEG / CR	48	A8	1994	2003	MEG / CR	48	TT	1999	2006	MEG / CR	48
MODELS	YEAR FROM	YEAR TO	TRANSPONDER TYPE	TRP ID																																		
A2	2000	2005	MEG / CR	48																																		
A3	1997	2003	MEG / CR	48																																		
A4	1999	2005	MEG / CR	48																																		
A6	1997	2005	MEG / CR	48																																		
A8	1994	2003	MEG / CR	48																																		
TT	1999	2006	MEG / CR	48																																		
FIAT®	<p>GT15RARS1</p>  <p>Available in Stock</p>	1 Button	<table border="1"> <thead> <tr> <th>MODELS</th> <th>YEAR FROM</th> <th>YEAR TO</th> <th>TRANSPONDER TYPE</th> <th>TRP ID</th> </tr> </thead> <tbody> <tr> <td>MULTIPLA</td> <td>1998</td> <td>2010</td> <td>MEG / CR</td> <td>48</td> </tr> <tr> <td>PALIO</td> <td>2002</td> <td></td> <td>MEG / CR</td> <td>48</td> </tr> <tr> <td>PUNTO</td> <td>1999</td> <td>2005</td> <td>MEG / CR</td> <td>48</td> </tr> <tr> <td>SEICENTO</td> <td>2000</td> <td>2010</td> <td>MEG / CR</td> <td>48</td> </tr> <tr> <td>SIENA</td> <td>2002</td> <td></td> <td>MEG / CR</td> <td>48</td> </tr> </tbody> </table>	MODELS	YEAR FROM	YEAR TO	TRANSPONDER TYPE	TRP ID	MULTIPLA	1998	2010	MEG / CR	48	PALIO	2002		MEG / CR	48	PUNTO	1999	2005	MEG / CR	48	SEICENTO	2000	2010	MEG / CR	48	SIENA	2002		MEG / CR	48					
MODELS	YEAR FROM	YEAR TO	TRANSPONDER TYPE	TRP ID																																		
MULTIPLA	1998	2010	MEG / CR	48																																		
PALIO	2002		MEG / CR	48																																		
PUNTO	1999	2005	MEG / CR	48																																		
SEICENTO	2000	2010	MEG / CR	48																																		
SIENA	2002		MEG / CR	48																																		





* The uses of the keys are purely indicative and may be subject to updates and revisions. / Gli utilizzi delle chiavi sono da considerarsi puramente indicativi e possono essere oggetto di aggiornamenti e revisioni. / Die Abbildung und technischen Daten der Schlüssel sind nicht bindend. Silca behält sich Änderungen am Produkt, die zur Verbesserung beitragen, vor. / Les usages des clés sont purement indicatifs; ils peuvent être mis à jour et revus. / Los usos de las llaves deben considerarse puramente indicativos y pueden ser objeto de actualizaciones y revisiones. / As utilizações das chaves devem ser consideradas puramente indicativas e podem ser objecto de actualizações e revisões.

© Registered Trademarks. / © Marchi Registrati. / © Eingetragene Marken. / © Marques Déposées. / © Marcas Registradas. / © Marcas Registradas.

Brand	References/Image	Specifications	Vehicle Models*																														
FIAT®	<p>SIP22ARS1</p>  <p>Available in Stock</p>	1 Button	<table border="1"> <thead> <tr> <th>MODELS</th> <th>YEAR FROM</th> <th>YEAR TO</th> <th>TRANSPONDER TYPE</th> <th>TRP ID</th> </tr> </thead> <tbody> <tr> <td>DOBLO'</td> <td>2000</td> <td>2006</td> <td>MEG / CR</td> <td>48</td> </tr> <tr> <td>DUCATO</td> <td>2002</td> <td>2005</td> <td>MEG / CR</td> <td>48</td> </tr> <tr> <td>IDEA</td> <td>2003</td> <td>2009</td> <td>MEG / CR</td> <td>48</td> </tr> <tr> <td>PUNTO</td> <td>2006</td> <td>2011</td> <td>MEG / CR</td> <td>48</td> </tr> <tr> <td>STILO</td> <td>2001</td> <td>2008</td> <td>MEG / CR</td> <td>48</td> </tr> </tbody> </table>	MODELS	YEAR FROM	YEAR TO	TRANSPONDER TYPE	TRP ID	DOBLO'	2000	2006	MEG / CR	48	DUCATO	2002	2005	MEG / CR	48	IDEA	2003	2009	MEG / CR	48	PUNTO	2006	2011	MEG / CR	48	STILO	2001	2008	MEG / CR	48
MODELS	YEAR FROM	YEAR TO	TRANSPONDER TYPE	TRP ID																													
DOBLO'	2000	2006	MEG / CR	48																													
DUCATO	2002	2005	MEG / CR	48																													
IDEA	2003	2009	MEG / CR	48																													
PUNTO	2006	2011	MEG / CR	48																													
STILO	2001	2008	MEG / CR	48																													
PEUGEOT®	<p>NE78ARS2N</p>  <p>Available in Stock</p>	2 Buttons - Flip NO battery holder	<table border="1"> <thead> <tr> <th>MODELS</th> <th>YEAR FROM</th> <th>YEAR TO</th> <th>TRANSPONDER TYPE</th> <th>TRP ID</th> </tr> </thead> <tbody> <tr> <td>406</td> <td>2002</td> <td>2004</td> <td>PH / CR2</td> <td>46</td> </tr> <tr> <td>607</td> <td>2004</td> <td>2010</td> <td>PH / CR2</td> <td>46</td> </tr> </tbody> </table>	MODELS	YEAR FROM	YEAR TO	TRANSPONDER TYPE	TRP ID	406	2002	2004	PH / CR2	46	607	2004	2010	PH / CR2	46															
MODELS	YEAR FROM	YEAR TO	TRANSPONDER TYPE	TRP ID																													
406	2002	2004	PH / CR2	46																													
607	2004	2010	PH / CR2	46																													
PEUGEOT®	<p>NE78BRS8</p>  <p>Available in Stock</p>	3 Buttons - Flip	<table border="1"> <thead> <tr> <th>MODELS</th> <th>YEAR FROM</th> <th>YEAR TO</th> <th>TRANSPONDER TYPE</th> <th>TRP ID</th> </tr> </thead> <tbody> <tr> <td>406</td> <td>2002</td> <td>2004</td> <td>PH / CR2</td> <td>46</td> </tr> <tr> <td>607</td> <td>2004</td> <td>2010</td> <td>PH / CR2</td> <td>46</td> </tr> </tbody> </table>	MODELS	YEAR FROM	YEAR TO	TRANSPONDER TYPE	TRP ID	406	2002	2004	PH / CR2	46	607	2004	2010	PH / CR2	46															
MODELS	YEAR FROM	YEAR TO	TRANSPONDER TYPE	TRP ID																													
406	2002	2004	PH / CR2	46																													
607	2004	2010	PH / CR2	46																													
PEUGEOT®	<p>NE78BRS8N</p>  <p>Available in Stock</p>	3 Buttons - Flip NO battery holder	<table border="1"> <thead> <tr> <th>MODELS</th> <th>YEAR FROM</th> <th>YEAR TO</th> <th>TRANSPONDER TYPE</th> <th>TRP ID</th> </tr> </thead> <tbody> <tr> <td>406</td> <td>2002</td> <td>2004</td> <td>PH / CR2</td> <td>46</td> </tr> <tr> <td>607</td> <td>2004</td> <td>2010</td> <td>PH / CR2</td> <td>46</td> </tr> </tbody> </table>	MODELS	YEAR FROM	YEAR TO	TRANSPONDER TYPE	TRP ID	406	2002	2004	PH / CR2	46	607	2004	2010	PH / CR2	46															
MODELS	YEAR FROM	YEAR TO	TRANSPONDER TYPE	TRP ID																													
406	2002	2004	PH / CR2	46																													
607	2004	2010	PH / CR2	46																													

* The uses of the keys are purely indicative and may be subject to updates and revisions. / Gli utilizzi delle chiavi sono da considerarsi puramente indicativi e possono essere oggetto di aggiornamenti e revisioni. / Die Abbildung und technischen Daten der Schlüssel sind nicht bindend. Silca behält sich Änderungen am Produkt, die zur Verbesserung beitragen, vor. / Les usages des clés sont purement indicatifs; ils peuvent être mis à jour et revus. / Los usos de las llaves deben considerarse puramente indicativos y pueden ser objeto de actualizaciones y revisiones. / As utilizações das chaves devem ser consideradas puramente indicativas e podem ser objecto de actualizações e revisões.

© Registered Trademarks. / © Marchi Registrati. / © Eingetragene Marken. / © Marques Déposées. / © Marcas Registradas. / © Marcas Registradas.

Brand	References/Image	Specifications	Vehicle Models*																																								
RENAULT®	<p>VAC102ARS1</p>  <p>Available in Stock</p>	1 Button	<table border="1"> <thead> <tr> <th>MODELS</th> <th>YEAR FROM</th> <th>YEAR TO</th> <th>TRANSPONDER TYPE</th> <th>TRP ID</th> </tr> </thead> <tbody> <tr> <td>CLIO</td> <td>1995</td> <td>2001</td> <td>PH</td> <td>33</td> </tr> <tr> <td>KANGOO</td> <td>1998</td> <td>2001</td> <td>PH</td> <td>33</td> </tr> <tr> <td>LAGUNA</td> <td>1995</td> <td>2000</td> <td>PH</td> <td>33</td> </tr> <tr> <td>SAFRANE</td> <td>1995</td> <td>2001</td> <td>PH</td> <td>33</td> </tr> </tbody> </table>	MODELS	YEAR FROM	YEAR TO	TRANSPONDER TYPE	TRP ID	CLIO	1995	2001	PH	33	KANGOO	1998	2001	PH	33	LAGUNA	1995	2000	PH	33	SAFRANE	1995	2001	PH	33															
MODELS	YEAR FROM	YEAR TO	TRANSPONDER TYPE	TRP ID																																							
CLIO	1995	2001	PH	33																																							
KANGOO	1998	2001	PH	33																																							
LAGUNA	1995	2000	PH	33																																							
SAFRANE	1995	2001	PH	33																																							
SEAT® See also: SKODA® VOLKSWAGEN®	<p>HURSA2</p>  <p>Available in Stock</p>	2 Buttons	<table border="1"> <thead> <tr> <th>MODELS</th> <th>YEAR FROM</th> <th>YEAR TO</th> <th>TRANSPONDER TYPE</th> <th>TRP ID</th> </tr> </thead> <tbody> <tr> <td>ALTEA</td> <td>2004</td> <td>2008</td> <td>MEG / CR</td> <td>A3</td> </tr> <tr> <td>ALTEA XL</td> <td>2006</td> <td>2008</td> <td>MEG / CR</td> <td>A3</td> </tr> <tr> <td>LEON</td> <td>2005</td> <td>2008</td> <td>MEG / CR</td> <td>A3</td> </tr> <tr> <td>TOLEDO</td> <td>2005</td> <td>2008</td> <td>MEG / CR</td> <td>A3</td> </tr> </tbody> </table>	MODELS	YEAR FROM	YEAR TO	TRANSPONDER TYPE	TRP ID	ALTEA	2004	2008	MEG / CR	A3	ALTEA XL	2006	2008	MEG / CR	A3	LEON	2005	2008	MEG / CR	A3	TOLEDO	2005	2008	MEG / CR	A3															
MODELS	YEAR FROM	YEAR TO	TRANSPONDER TYPE	TRP ID																																							
ALTEA	2004	2008	MEG / CR	A3																																							
ALTEA XL	2006	2008	MEG / CR	A3																																							
LEON	2005	2008	MEG / CR	A3																																							
TOLEDO	2005	2008	MEG / CR	A3																																							
SKODA® See also: SEAT® VOLKSWAGEN®	<p>HURSA2</p>  <p>Available in Stock</p>	2 Buttons	<table border="1"> <thead> <tr> <th>MODELS</th> <th>YEAR FROM</th> <th>YEAR TO</th> <th>TRANSPONDER TYPE</th> <th>TRP ID</th> </tr> </thead> <tbody> <tr> <td>OCTAVIA</td> <td>2004</td> <td>2006</td> <td>MEG / CR</td> <td>A4</td> </tr> <tr> <td>ROOMSTER</td> <td>2006</td> <td>2008</td> <td>MEG / CR</td> <td>A4</td> </tr> <tr> <td>ROOMSTER SCOUT</td> <td>2007</td> <td>2008</td> <td>MEG / CR</td> <td>A4</td> </tr> </tbody> </table>	MODELS	YEAR FROM	YEAR TO	TRANSPONDER TYPE	TRP ID	OCTAVIA	2004	2006	MEG / CR	A4	ROOMSTER	2006	2008	MEG / CR	A4	ROOMSTER SCOUT	2007	2008	MEG / CR	A4																				
MODELS	YEAR FROM	YEAR TO	TRANSPONDER TYPE	TRP ID																																							
OCTAVIA	2004	2006	MEG / CR	A4																																							
ROOMSTER	2006	2008	MEG / CR	A4																																							
ROOMSTER SCOUT	2007	2008	MEG / CR	A4																																							
VOLKSWAGEN® See also: SEAT® SKODA®	<p>HURSA2</p>  <p>Available in Stock</p>	2 Buttons	<table border="1"> <thead> <tr> <th>MODELS</th> <th>YEAR FROM</th> <th>YEAR TO</th> <th>TRANSPONDER TYPE</th> <th>TRP ID</th> </tr> </thead> <tbody> <tr> <td>CROSS GOLF</td> <td>2006</td> <td>2007</td> <td>MEG / CR</td> <td>A1</td> </tr> <tr> <td>EOS</td> <td>2006</td> <td>2007</td> <td>MEG / CR</td> <td>A1</td> </tr> <tr> <td>GOLF</td> <td>2004</td> <td>2008</td> <td>MEG / CR</td> <td>A1</td> </tr> <tr> <td>INDIVIDUAL</td> <td>2004</td> <td>2008</td> <td>MEG / CR</td> <td>A1</td> </tr> <tr> <td>JETTA</td> <td>2004</td> <td>2007</td> <td>MEG / CR</td> <td>A1</td> </tr> <tr> <td>PASSAT</td> <td>2004</td> <td>2005</td> <td>MEG / CR</td> <td>A1</td> </tr> <tr> <td>TOURAN</td> <td>2003</td> <td>2007</td> <td>MEG / CR</td> <td>A1</td> </tr> </tbody> </table>	MODELS	YEAR FROM	YEAR TO	TRANSPONDER TYPE	TRP ID	CROSS GOLF	2006	2007	MEG / CR	A1	EOS	2006	2007	MEG / CR	A1	GOLF	2004	2008	MEG / CR	A1	INDIVIDUAL	2004	2008	MEG / CR	A1	JETTA	2004	2007	MEG / CR	A1	PASSAT	2004	2005	MEG / CR	A1	TOURAN	2003	2007	MEG / CR	A1
MODELS	YEAR FROM	YEAR TO	TRANSPONDER TYPE	TRP ID																																							
CROSS GOLF	2006	2007	MEG / CR	A1																																							
EOS	2006	2007	MEG / CR	A1																																							
GOLF	2004	2008	MEG / CR	A1																																							
INDIVIDUAL	2004	2008	MEG / CR	A1																																							
JETTA	2004	2007	MEG / CR	A1																																							
PASSAT	2004	2005	MEG / CR	A1																																							
TOURAN	2003	2007	MEG / CR	A1																																							

* The uses of the keys are purely indicative and may be subject to updates and revisions. / Gli utilizzi delle chiavi sono da considerarsi puramente indicativi e possono essere oggetto di aggiornamenti e revisioni. / Die Abbildung und technischen Daten der Schlüssel sind nicht bindend. Silca behält sich Änderungen am Produkt, die zur Verbesserung beitragen, vor. / Les usages des clés sont purement indicatifs; ils peuvent être mis à jour et revus. / Los usos de las llaves deben considerarse puramente indicativos y pueden ser objeto de actualizaciones y revisiones. / As utilizações das chaves devem ser consideradas puramente indicativas e podem ser objecto de actualizações e revisões.

® Registered Trademarks. / ® Marchi Registrati. / ® Eingetragene Marken. / ® Marques Déposées. / ® Marcas Registradas. / ® Marcas Registradas.

NEW

FUTURA PROGRAMS - UPDATES

Futura Version 2.4.3

new series



Futura

Data update with new series / Aggiornamento dati con nuove serie
Datenaktualisierung mit neuen Serien / Mise à jour des données avec nouvelle séries / Actualización datos con nuevas series / Atualização dados com novas séries

New items include/Tra le novità/Unter den Neuheiten/Parmi les nouveautés
Entre las novedades/Entre as novidades:

- Atra® New Power (7W-2P)
- Bajaj® (Indian Market)
- Best® (A3)
- Hero® Honda® (Indian Market)
- Mahindra® (Indian Market)
- Russwin® (A old Class - 981 Class - 752 Class)
- Yamaha® (Indian Market)

FUTURA APP INSTALLATION



After you updated the Futura machine's software (vers. 2.4.3) is necessary to download and install the "Futura App" and the customized "Silca Keyboard".

Proceed as follows:

- 1) Make the Wi-Fi Tablet-Futura connection.
- 2) Open the **browser Chrome** and enter the following addresses:
to download the App Futura: **192.168.0.1/Silca.apk**
to download the keyboard: **192.168.0.1/SilcaKeyboard.apk**
- 3) Both Applications that were just downloaded should be found in "Downloads" application. Tap on them to install.

Check out the "**Futura**" page on the Silca site to know more.
Consulta il sito Silca alla **pagina "Futura"** per saperne di più.
Sehen Sie den **Seite "Futura"** auf Silca Website, um weitere Informationen zu finden.
Consultez la **page "Futura"** sur notre site Silca pour en savoir plus.
Visite la **página "Futura"** en el sitio Silca para más informaciones.
Consulte a **página "Futura"** no site Silca para saber mais.

FOR:
PER:

ABUS (D)

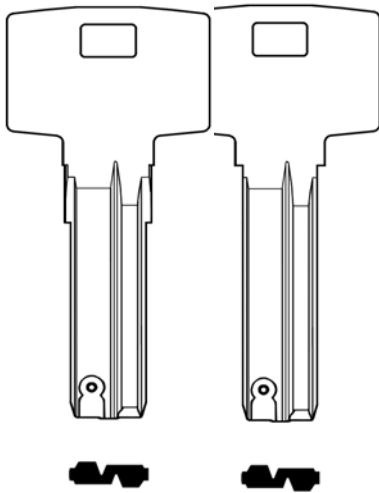

Bravus

(1000 - 2000 - 3000 - 4000)

System protected by a password issued by Silca on receipt of authorization.

Sistema protetto da password rilasciata da Silca a fronte di autorizzazione.

System geschützt durch von Silca geliefertes Password auf Genehmigung.

Système protégé par un password qui est émis par Silca sur autorisation.

Sistema protegido por password que expide Silca contra autorización.

Sistema protegido por uma password emitida por Silca contra a autorização.



FUTURA

OPTIONAL



D744315ZB

29J Jaw
Ganascia 29J
29J Backe
Mâchoire 29J
Quijada 29J
Garra 29J



OPTIONAL



D744317ZB

30J Jaw
Ganascia 30J
30J Backe
Mâchoire 30J
Quijada 30J
Garra 30J

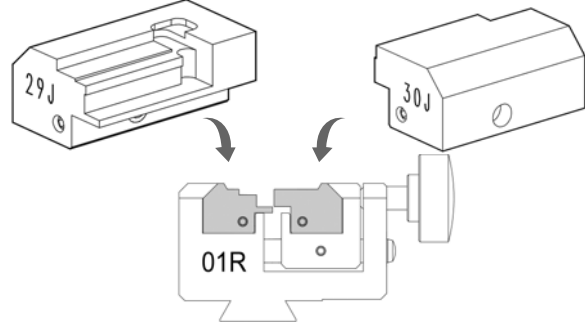

Delivery time DECEMBER 2014
Disponibilità DICEMBRE 2014
Lieferbar DEZEMBER 2014
Disponibilité DECEMBRE 2014
Disponibilidad DICIEMBRE 2014
Disponibilidade DEZEMBRO 2014

1000 - 2000 - 3000 systems

OPTIONAL



D744355ZB

Cutter 07D
Fresa 07D
Fräser 07D
Fraise 07D
Fresa 07D
Fresa 07D



4000 system

OPTIONAL



D744355ZB

Cutter 07D
Fresa 07D
Fräser 07D
Fraise 07D
Fresa 07D
Fresa 07D

OPTIONAL



D743672ZB

Cutter 03L
Fresa 03L
Fräser 03L
Fraise 03L
Fresa 03L
Fresa 03L

FOR:
PER:

ASSA (S)

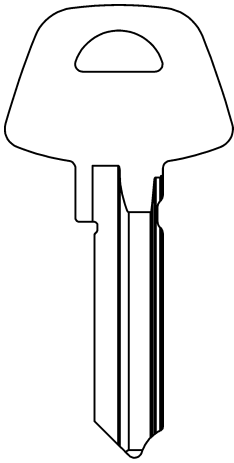

(D-12)

System protected by a password issued by Silca on receipt of authorization.

Sistema protetto da password rilasciata da Silca a fronte di autorizzazione.

System geschützt durch von Silca geliefertes Passwort auf Genehmigung.

Système protégé par un password qui est émis par Silca sur autorisation.

Sistema protegido por password que expide Silca contra autorización.

Sistema protegido por uma password emitida por Silca contra a autorização.



FUTURA

OPTIONAL



D744283ZB

20J Jaw
Ganascia 20J
20J Backe
Mâchoire 20J
Quijada 20J
Garra 20J



OPTIONAL



D744284ZB

21J Jaw
Ganascia 21J
21J Backe
Mâchoire 21J
Quijada 21J
Garra 21J

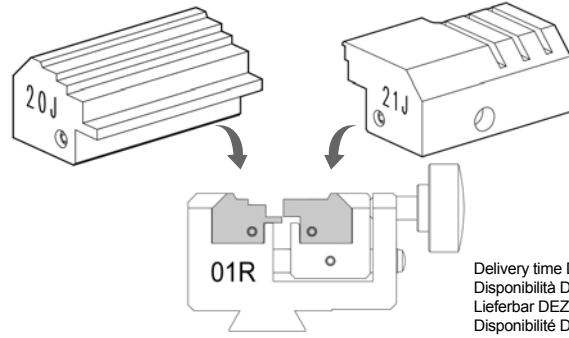

Delivery time DECEMBER 2014
Disponibilità DICEMBRE 2014
Lieferbar DEZEMBER 2014
Disponibilité DECEMBRE 2014
Disponibilidad DICIEMBRE 2014
Disponibilidade DEZEMBRO 2014

OPTIONAL



D743745ZB

Cutter 04L
Fresa 04L
Fräser 04L
Fraise 04L
Fresa 04L

OPTIONAL



D743271ZB

02V clamp for ASSA type keys
Morsetto 02V per chiavi tipo ASSA
Spannbacke 02V für ASSA Schlüsseltyp
Etau 02V pour clés type ASSA
Mordaza 02V para llaves de tipo ASSA
Mordente 02V para chaves do tipo ASSA

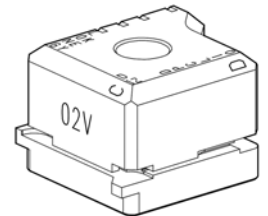

FOR:
PER:

DOM (D)

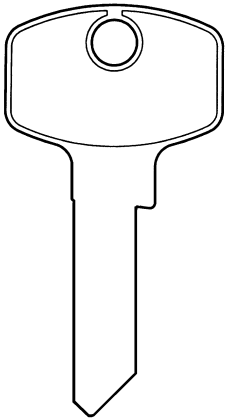

(Prof. 145)
SIGMA

System protected by a password issued by Silca on receipt of authorization.

Sistema protetto da password rilasciata da Silca a fronte di autorizzazione.

System geschützt durch von Silca geliefertes Passwort auf Genehmigung.

Système protégé par un password qui est émis par Silca sur autorisation.

Sistema protegido por password que expide Silca contra autorización.

Sistema protegido por uma password emitida por Silca contra a autorização.



FUTURA

OPTIONAL



D744319ZB

31J Jaw
Ganascia 31J
31J Backe
Mâchoire 31J
Quijada 31J
Garra 31J



OPTIONAL



D744321ZB

32J Jaw
Ganascia 32J
32J Backe
Mâchoire 32J
Quijada 32J
Garra 32J

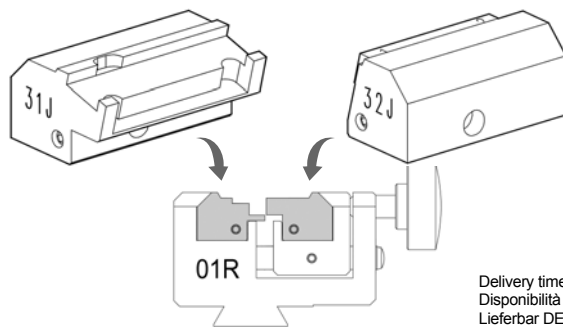

Delivery time DECEMBER 2014
Disponibilità DICEMBRE 2014
Lieferbar DEZEMBER 2014
Disponibilité DECEMBRE 2014
Disponibilidad DICIEMBRE 2014
Disponibilidade DEZEMBRO 2014

OPTIONAL



D744354ZB

Cutter 05D
Fresa 05D
Fräser 05D
Fraise 05D
Fresa 05D



FOR:
PER:

DOM (D)

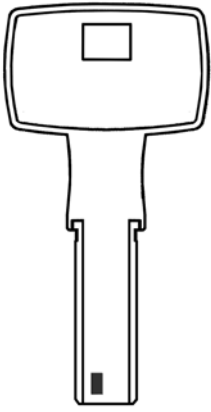

(IXSATS)

System protected by a password issued by Silca on receipt of authorization.

Sistema protetto da password rilasciata da Silca a fronte di autorizzazione.

System geschützt durch von Silca geliefertes Passwort auf Genehmigung.

Système protégé par un password qui est émis par Silca sur autorisation.

Sistema protegido por password que expide Silca contra autorización.

Sistema protegido por uma password emitida por Silca contra a autorização.



QUATTROCODE

OPTIONAL

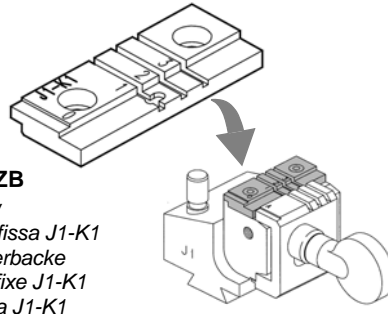

D744470ZB

J1-K1 Jaw
Ganascia fissa J1-K1
J1-K1 Fixerbacke
Mâchoire fixe J1-K1
Quijada fija J1-K1
Garra fixa J1-K1



Delivery time DECEMBER 2014
Disponibilità DICEMBRE 2014
Lieferbar DEZEMBER 2014
Disponibilit  DECEMBRE 2014
Disponibilidad DICIEMBRE 2014
Disponibilidade DEZEMBRO 2014

OPTIONAL



D738415ZB

Cutter W153
Fresa W153
Fr ser W153
Fraise W153
Fresa W153
Fresa W153

OPTIONAL



D709116ZB

Cutter H104
Fresa H104
Fr ser H104
Fraise H104
Fresa H104
Fresa H104

D709241ZB

Cutter W104
Fresa W104
Fr ser W104
Fraise W104
Fresa W104
Fresa W104



TRIAX QUATTRO
TRIAX-E.CODE

OPTIONAL

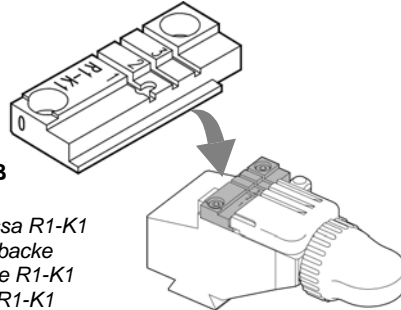

D744468ZB

R1-K1 Jaw
Ganascia fissa R1-K1
R1-K1 Fixerbacke
M choire fixe R1-K1
Quijada fija R1-K1
Garra fixa R1-K1



Delivery time DECEMBER 2014
Disponibilit  DICEMBRE 2014
Lieferbar DEZEMBER 2014
Disponibilit  DECEMBRE 2014
Disponibilidad DICIEMBRE 2014
Disponibilidade DEZEMBRO 2014

OPTIONAL



D738415ZB

Cutter W153
Fresa W153
Fr ser W153
Fraise W153
Fresa W153
Fresa W153

OPTIONAL

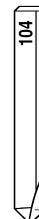

D709116ZB

Cutter H104
Fresa H104
Fr ser H104
Fraise H104
Fresa H104
Fresa H104

D709241ZB

Cutter W104
Fresa W104
Fr ser W104
Fraise W104
Fresa W104
Fresa W104

FOR:
PER:

KABA (CH)

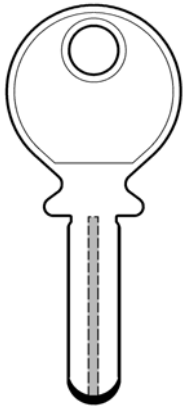

maTrix
(K59)



FUTURA

OPTIONAL



D744295ZB

33J Jaw
Ganascia 33J
33J Backe
Mâchoire 33J
Quijada 33J
Garra 33J



OPTIONAL



D744296ZB

34J Jaw
Ganascia 34J
34J Backe
Mâchoire 34J
Quijada 34J
Garra 34J

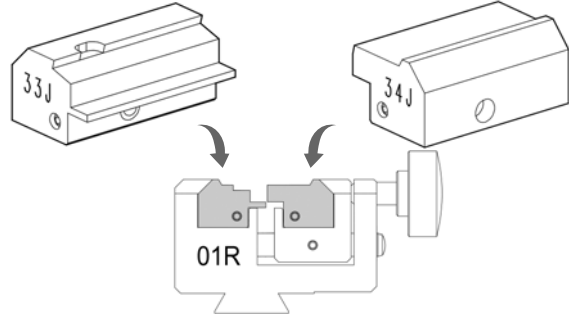

STANDARD



D742867ZB

Cutter 01D
Fresa 01D
Fräser 01D
Fraise 01D
Fresa 01D
Fresa 01D

FOR:
PER:

KESO (CH)

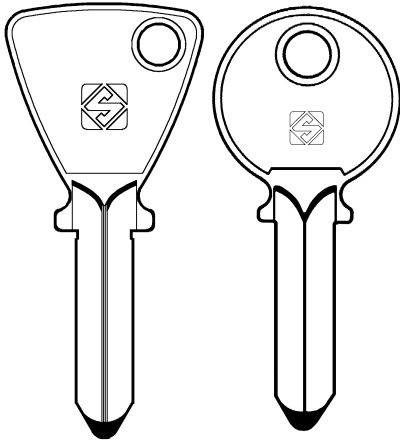

KE1



KE2

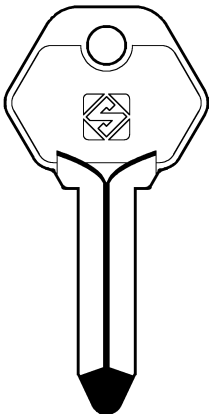

KE4

(1000 System)



FUTURA

OPTIONAL



D744291ZB

26J Jaw
Ganascia 26J
26J Backe
Mâchoire 26J
Quijada 26J
Garra 26J



OPTIONAL



D744292ZB

27J Jaw
Ganascia 27J
27J Backe
Mâchoire 27J
Quijada 27J
Garra 27J

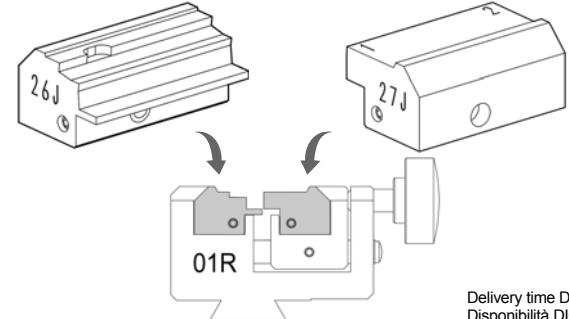

STANDARD



D742867ZB

Cutter 01D
Fresa 01D
Fräser 01D
Fraise 01D
Fresa 01D
Fresa 01D

OPTIONAL



D743674ZB

Cutter 03D
Fresa 03D
Fräser 03D
Fraise 03D
Fresa 03D
Fresa 03D

Delivery time DECEMBER 2014
Disponibilità DICEMBRE 2014
Lieferbar DEZEMBER 2014
Disponibilit  DECEMBRE 2014
Disponibilidad DICIEMBRE 2014
Disponibilidade DEZEMBRO 2014

FOR:
PER:

MAGNUM (GB)

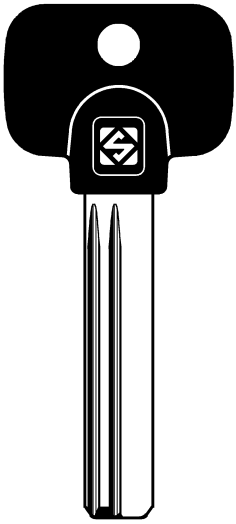

MGN1RP

Magnum Superior
(5+4) (4+3) (3+2)

Magnum Superior +
(5+4) (4+3) (3+2)



FUTURA

OPTIONAL D744363ZB



35J Jaw
Ganascia 35J
35J Backe
Mâchoire 35J
Quijada 35J
Garra 35J

OPTIONAL D744365ZB



36J Jaw
Ganascia 36J
36J Backe
Mâchoire 36J
Quijada 36J
Garra 36J

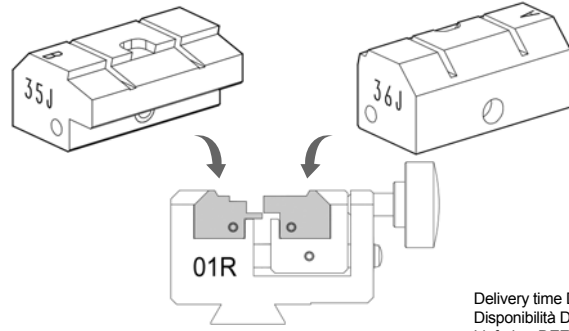

Delivery time DECEMBER 2014
Disponibilit  DICEMBRE 2014
Lieferbar DEZEMBER 2014
Disponibilit  DECEMBRE 2014
Disponibilidad DICIEMBRE 2014
Disponibilidade DEZEMBRO 2014

OPTIONAL



D743673ZB

Cutter 02D
Fresa 02D
Fr ser 02D
Fraise 02D
Fresa 02D
Fresa 02D

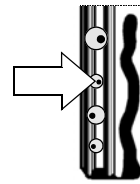

STANDARD D943253ZR



01J Jaw
Ganascia 01J
01J Backe
M choire 01J
Quijada 01J
Garra 01J

STANDARD D943254ZR



02J Jaw
Ganascia 02J
02J Backe
M choire 02J
Quijada 02J
Garra 02J

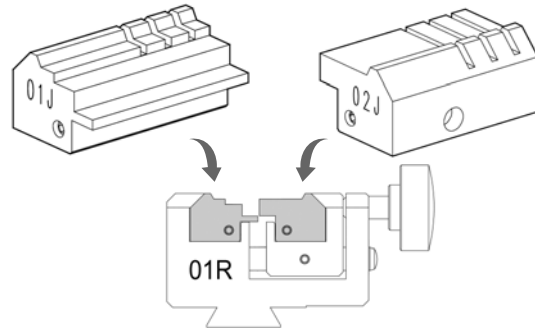

OPTIONAL



D743745ZB

Cutter 04L
Fresa 04L
Fr ser 04L
Fraise 04L
Fresa 04L
Fresa 04L

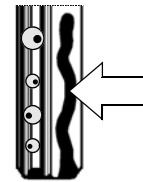

FOR: **PFAFFENHAIN (D)**
 PER:

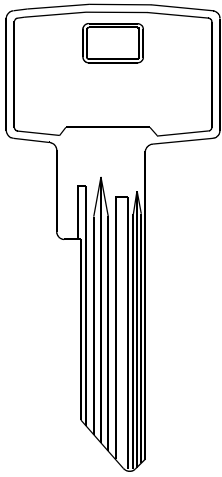

(K14)



FUTURA

OPTIONAL



D744309ZB

24J Jaw
 Ganascia 24J
 24J Backe
 Mâchoire 24J
 Quijada 24J
 Garra 24J



OPTIONAL



D744311ZB

25J Jaw
 Ganascia 25J
 25J Backe
 Mâchoire 25J
 Quijada 25J
 Garra 25J

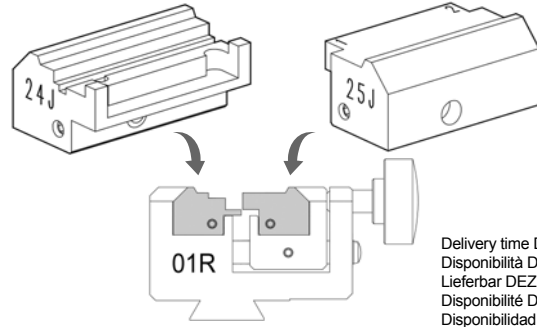

Delivery time DECEMBER 2014
 Disponibilit  DICEMBRE 2014
 Lieferbar DEZEMBER 2014
 Disponibilit  DECEMBRE 2014
 Disponibilidad DICIEMBRE 2014
 Disponibilidade DEZEMBRO 2014

STANDARD



D742867ZB

Cutter 01D
 Fresa 01D
 Fr ser 01D
 Fraise 01D
 Fresa 01D
 Fresa 01D

STANDARD



D942846ZR

01V clamp
 Morsetto 01V
 Spannbacke 01V
 Etau 01V
 Mordaza 01V
 Mordente 01V

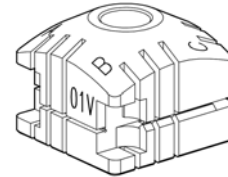

FOR: **PFAFFENHAIN (D)**
 PER:

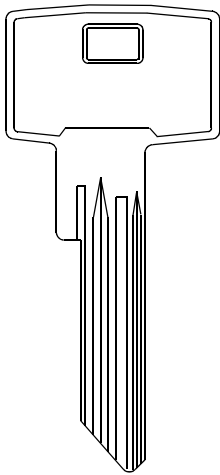

(KV14 - XY14)

(KV14 - XV14)



FUTURA

OPTIONAL



D744313ZB

28J Jaw
 Ganascia 28J
 28J Backe
 Mâchoire 28J
 Quijada 28J
 Garra 28J



OPTIONAL



D744311ZB

25J Jaw
 Ganascia 25J
 25J Backe
 Mâchoire 25J
 Quijada 25J
 Garra 25J

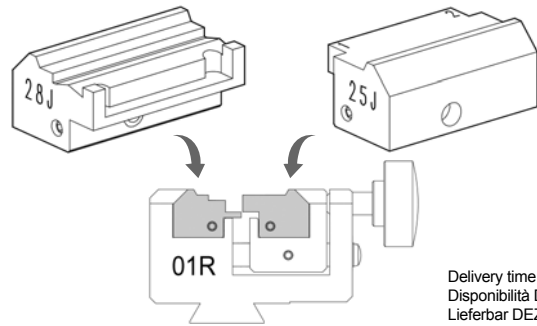

Delivery time DECEMBER 2014
 Disponibilit  DICEMBRE 2014
 Lieferbar DEZEMBER 2014
 Disponibilit  DECEMBRE 2014
 Disponibilidad DICIEMBRE 2014
 Disponibilidade DEZEMBRO 2014

STANDARD



D742867ZB

Cutter 01D
 Fresa 01D
 Fr ser 01D
 Fraise 01D
 Fresa 01D
 Fresa 01D

OPTIONAL



D744373ZB

Clamp 04V
 Morsetto 04V
 Spannbacke 04V
 Etau 04V
 Mordaza 04V
 Mordente 04V

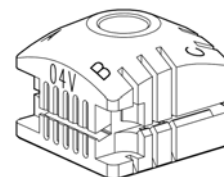

Delivery time DECEMBER 2014
 Disponibilit  DICEMBRE 2014
 Lieferbar DEZEMBER 2014
 Disponibilit  DECEMBRE 2014
 Disponibilidad DICIEMBRE 2014
 Disponibilidade DEZEMBRO 2014

FOR: **VACHETTE (F)**
PER:

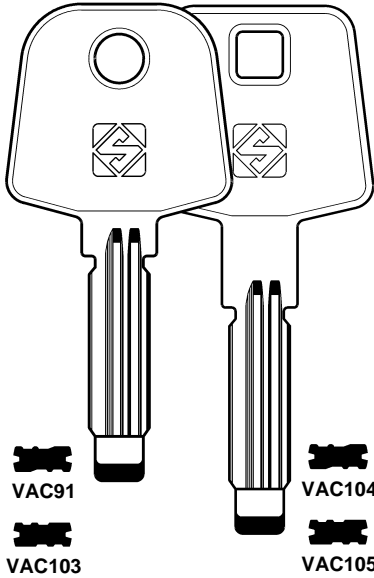

(VACHETTE RADIAL)



FUTURA

OPTIONAL



D744287ZB

22J Jaw
Ganascia 22J
22J Backe
Mâchoire 22J
Quijada 22J
Garra 22J



OPTIONAL



D744288ZB

23J Jaw
Ganascia 23J
23J Backe
Mâchoire 23J
Quijada 23J
Garra 23J

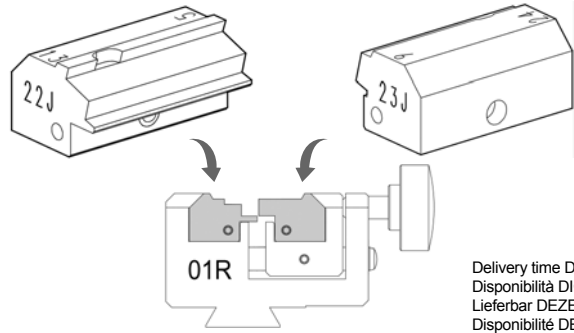

Delivery time DECEMBER 2014
Disponibilità DICEMBRE 2014
Lieferbar DEZEMBER 2014
Disponibilit  DECEMBRE 2014
Disponibilidad DICIEMBRE 2014
Disponibilidade DEZEMBRO 2014

OPTIONAL



D743674ZB

Cutter 03D
Fresa 03D
Fr ser 03D
Fraise 03D
Fresa 03D
Fresa 03D

FOR: **WINKHAUS (D)**
PER:

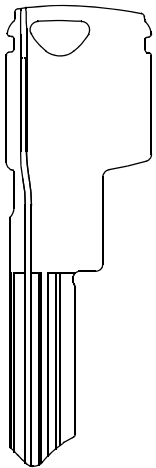

(RPE - RPS)



FUTURA

OPTIONAL



D744309ZB

24J Jaw
Ganascia 24J
24J Backe
M choire 24J
Quijada 24J
Garra 24J



OPTIONAL



D744311ZB

25J Jaw
Ganascia 25J
25J Backe
M choire 25J
Quijada 25J
Garra 25J

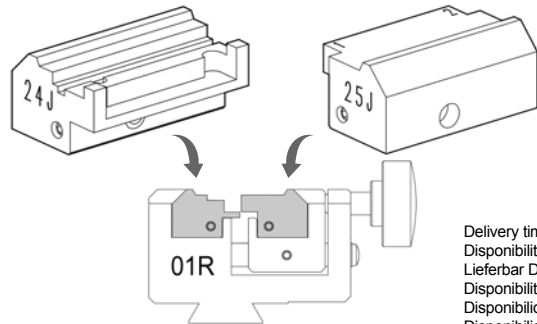

Delivery time DECEMBER 2014
Disponibilit  DICEMBRE 2014
Lieferbar DEZEMBER 2014
Disponibilit  DECEMBRE 2014
Disponibilidad DICIEMBRE 2014
Disponibilidade DEZEMBRO 2014

OPTIONAL



D744353ZB

Cutter 06D
Fresa 06D
Fr ser 06D
Fraise 06D
Fresa 06D
Fresa 06D



OPTIONAL



D744369ZB

Clamp 03V
Morsetto 03V
Spannbacke 03V
Etau 03V
Mordaza 03V
Mordente 03V

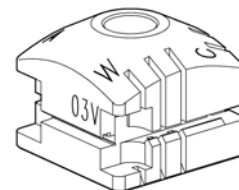

Delivery time DECEMBER 2014
Disponibilit  DICEMBRE 2014
Lieferbar DEZEMBER 2014
Disponibilit  DECEMBRE 2014
Disponibilidad DICIEMBRE 2014
Disponibilidade DEZEMBRO 2014

System protected by a password issued by Silca on receipt of authorization.

Sistema protetto da password rilasciata da Silca a fronte di autorizzazione.

System gesch tzt durch von Silca geliefertes Password auf Genehmigung.

Syst me prot g  par un password qui est  mis par Silca sur autorisation.

Sistema protegido por password que expide Silca contra autorizaci n.

Sistema protegido por uma password emitida por Silca contra a autoriza o.

2015

Happy New Year Счастливого Нового Года
 Felice Anno Nuovo Ευτυχισμένο Το Νέο Έτος
 Guten Rutch Ins Neue Jahr Gott Nitt Ar
 Bonne Année Hyvaa Joulua
 Feliz Año Nuevo Godt Nytt Ar
 Feliz Ano Novo 新年快乐
 Gelukkig Nieuw Jaar عدي عس عدي دج قنس



JANUARY 2014

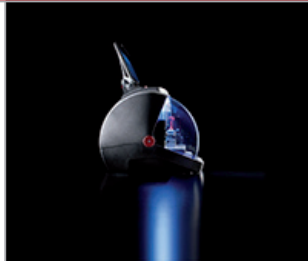

FEBRUARY 2014



MARCH 2014



APRIL 2014



MAY 2014



JUNE 2014



JULY 2014



AUGUST 2014



SEPTEMBER 2014



OCTOBER 2014



NOVEMBER 2014



DECEMBER 2014

DECEMBER NEWS

- New Cylinder Keys
- Empty Shells: 8 new references
- The Simpsons™ - 25th Anniversary Collection
- Art Keys Best Sellers Collection
- MySilca App
- EKC: Comparative Function
- Silca Key Programs: Update 2/2014
- New KCM Optionals



New Keys / Chiavi Nuove / Neue Schlüssel / Nouvelles Clés
Llaves Nuevas / Chaves Novas

FOR: **MLM**
PER:

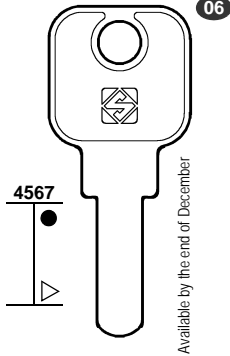

06

4567

Available by the end of December

MLM15



FOR: **RONIS**
PER:

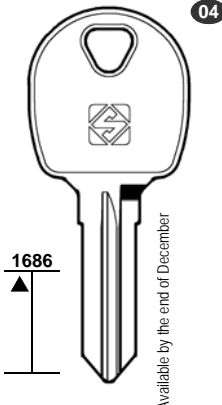

04

1686

Available by the end of December

RO84

FOR / PER

MLM (D)

RONIS (F)

01

COMMERCIAL GROUP
GRUPPO COMMERCIALE
PREISEGRUPPE
GROUPE COMMERCIAL
GRUPO COMMERCIAL
GRUPO COMERCIAL

www.silca.biz

SILCA EMPTY SHELLS - NEW REFERENCES

 Silca Empty Shells: **8 new keys references** to widen the existing range.

 Silca Empty Shells: **8 nouvelles références** clés qui complètent la gamme existante.

 Silca Empty Shells: **8 nuove referenze** chiavi che implementano la gamma già esistente.

 Silca Empty Shells: **8 nuevas referencias** llaves que completan la gama existente.





 Silca Empty Shells: **8 Schlüssel Referenzen** die das bestehende Angebot implementieren.

 Silca Empty Shells: **8 novas referências** chaves que implementam a gama existente.

Brand	References/Image	Specifications	Vehicle Models*																									
BMW®	<p>HU58RS2N</p>  <p>Available in Stock</p>	2 Buttons NO battery holder	<table border="1"> <thead> <tr> <th>MODELS</th> <th>YEAR FROM</th> <th>YEAR TO</th> <th>TRANSPONDER TYPE</th> <th>TRP ID</th> </tr> </thead> <tbody> <tr> <td>SERIE 3</td> <td>1995</td> <td>2001</td> <td>PH</td> <td>33</td> </tr> <tr> <td>SERIE 5</td> <td>1996</td> <td>2003</td> <td>PH</td> <td>33</td> </tr> <tr> <td>SERIE 7</td> <td>1994</td> <td>2001</td> <td>PH</td> <td>33</td> </tr> <tr> <td>Z3</td> <td>1995</td> <td>2002</td> <td>PH</td> <td>33</td> </tr> </tbody> </table>	MODELS	YEAR FROM	YEAR TO	TRANSPONDER TYPE	TRP ID	SERIE 3	1995	2001	PH	33	SERIE 5	1996	2003	PH	33	SERIE 7	1994	2001	PH	33	Z3	1995	2002	PH	33
MODELS	YEAR FROM	YEAR TO	TRANSPONDER TYPE	TRP ID																								
SERIE 3	1995	2001	PH	33																								
SERIE 5	1996	2003	PH	33																								
SERIE 7	1994	2001	PH	33																								
Z3	1995	2002	PH	33																								
BMW®	<p>HU58RS8N</p>  <p>Available in Stock</p>	3 Buttons NO battery holder	<table border="1"> <thead> <tr> <th>MODELS</th> <th>YEAR FROM</th> <th>YEAR TO</th> <th>TRANSPONDER TYPE</th> <th>TRP ID</th> </tr> </thead> <tbody> <tr> <td>SERIE 3</td> <td>1995</td> <td>2001</td> <td>PH</td> <td>33</td> </tr> <tr> <td>SERIE 5</td> <td>1996</td> <td>2003</td> <td>PH</td> <td>33</td> </tr> <tr> <td>SERIE 7</td> <td>1994</td> <td>2001</td> <td>PH</td> <td>33</td> </tr> </tbody> </table>	MODELS	YEAR FROM	YEAR TO	TRANSPONDER TYPE	TRP ID	SERIE 3	1995	2001	PH	33	SERIE 5	1996	2003	PH	33	SERIE 7	1994	2001	PH	33					
MODELS	YEAR FROM	YEAR TO	TRANSPONDER TYPE	TRP ID																								
SERIE 3	1995	2001	PH	33																								
SERIE 5	1996	2003	PH	33																								
SERIE 7	1994	2001	PH	33																								
BMW®	<p>HU92RRS2N</p>  <p>Available in Stock</p>	2 Buttons NO battery holder	<table border="1"> <thead> <tr> <th>MODELS</th> <th>YEAR FROM</th> <th>YEAR TO</th> <th>TRANSPONDER TYPE</th> <th>TRP ID</th> </tr> </thead> <tbody> <tr> <td>SERIE 3</td> <td>1995</td> <td>2001</td> <td>PH</td> <td>33</td> </tr> <tr> <td>SERIE 5</td> <td>1996</td> <td>2003</td> <td>PH</td> <td>33</td> </tr> <tr> <td>SERIE 7</td> <td>1994</td> <td>2001</td> <td>PH</td> <td>33</td> </tr> <tr> <td>Z3</td> <td>1995</td> <td>2002</td> <td>PH</td> <td>33</td> </tr> </tbody> </table>	MODELS	YEAR FROM	YEAR TO	TRANSPONDER TYPE	TRP ID	SERIE 3	1995	2001	PH	33	SERIE 5	1996	2003	PH	33	SERIE 7	1994	2001	PH	33	Z3	1995	2002	PH	33
MODELS	YEAR FROM	YEAR TO	TRANSPONDER TYPE	TRP ID																								
SERIE 3	1995	2001	PH	33																								
SERIE 5	1996	2003	PH	33																								
SERIE 7	1994	2001	PH	33																								
Z3	1995	2002	PH	33																								

* The uses of the keys are purely indicative and may be subject to updates and revisions. / Gli utilizzi delle chiavi sono da considerarsi puramente indicativi e possono essere oggetto di aggiornamenti e revisioni. / Die Abbildung und technischen Daten der Schlüssel sind nicht bindend. Silca behält sich Änderungen am Produkt, die zur Verbesserung beitragen, vor. / Les usages des clés sont purement indicatifs; ils peuvent être mis à jour et revus. / Los usos de las llaves deben considerarse puramente indicativos y pueden ser objeto de actualizaciones y revisiones. / As utilizações das chaves devem ser consideradas puramente indicativas e podem ser objecto de actualizações e revisões.

© Registered Trademarks. / © Marchi Registrati. / © Eingetragene Marken. / © Marques Déposées. / © Marcas Registradas. / © Marcas Registradas.

Brand	References/Image	Specifications	Vehicle Models*																									
BMW®	<p>HU92RRS8N</p>  <p>Available in Stock</p>	3 Buttons NO battery holder	<table border="1"> <thead> <tr> <th>MODELS</th> <th>YEAR FROM</th> <th>YEAR TO</th> <th>TRANSPONDER TYPE</th> <th>TRP ID</th> </tr> </thead> <tbody> <tr> <td>SERIE 3</td> <td>1995</td> <td>2001</td> <td>PH</td> <td>33</td> </tr> <tr> <td>SERIE 5</td> <td>1996</td> <td>2003</td> <td>PH</td> <td>33</td> </tr> <tr> <td>SERIE 7</td> <td>1994</td> <td>2001</td> <td>PH</td> <td>33</td> </tr> </tbody> </table>	MODELS	YEAR FROM	YEAR TO	TRANSPONDER TYPE	TRP ID	SERIE 3	1995	2001	PH	33	SERIE 5	1996	2003	PH	33	SERIE 7	1994	2001	PH	33					
MODELS	YEAR FROM	YEAR TO	TRANSPONDER TYPE	TRP ID																								
SERIE 3	1995	2001	PH	33																								
SERIE 5	1996	2003	PH	33																								
SERIE 7	1994	2001	PH	33																								
CITROËN®	<p>SX9ARS2</p>  <p>Available in Stock</p>	2 Buttons	<table border="1"> <thead> <tr> <th>MODELS</th> <th>YEAR FROM</th> <th>YEAR TO</th> <th>TRANSPONDER TYPE</th> <th>TRP ID</th> </tr> </thead> <tbody> <tr> <td>BERLINGO</td> <td>1998</td> <td>2001</td> <td>PH</td> <td>33</td> </tr> <tr> <td>EVASION</td> <td>1992</td> <td>2002</td> <td>PH</td> <td>33</td> </tr> <tr> <td>SAXO</td> <td>1998</td> <td>2000</td> <td>PH</td> <td>33</td> </tr> <tr> <td>XSARA</td> <td>1998</td> <td>2001</td> <td>PH</td> <td>33</td> </tr> </tbody> </table>	MODELS	YEAR FROM	YEAR TO	TRANSPONDER TYPE	TRP ID	BERLINGO	1998	2001	PH	33	EVASION	1992	2002	PH	33	SAXO	1998	2000	PH	33	XSARA	1998	2001	PH	33
MODELS	YEAR FROM	YEAR TO	TRANSPONDER TYPE	TRP ID																								
BERLINGO	1998	2001	PH	33																								
EVASION	1992	2002	PH	33																								
SAXO	1998	2000	PH	33																								
XSARA	1998	2001	PH	33																								
CITROËN®	<p>SXRSA2</p>  <p>Available in Stock</p>	2 Buttons	<table border="1"> <thead> <tr> <th>MODELS</th> <th>YEAR FROM</th> <th>YEAR TO</th> <th>TRANSPONDER TYPE</th> <th>TRP ID</th> </tr> </thead> <tbody> <tr> <td>BERLINGO</td> <td>1998</td> <td>2001</td> <td>PH</td> <td>33</td> </tr> <tr> <td>EVASION</td> <td>1998</td> <td>2002</td> <td>PH</td> <td>33</td> </tr> <tr> <td>SAXO</td> <td>1998</td> <td>2000</td> <td>PH</td> <td>33</td> </tr> <tr> <td>XSARA</td> <td>1998</td> <td>2001</td> <td>PH</td> <td>33</td> </tr> </tbody> </table>	MODELS	YEAR FROM	YEAR TO	TRANSPONDER TYPE	TRP ID	BERLINGO	1998	2001	PH	33	EVASION	1998	2002	PH	33	SAXO	1998	2000	PH	33	XSARA	1998	2001	PH	33
MODELS	YEAR FROM	YEAR TO	TRANSPONDER TYPE	TRP ID																								
BERLINGO	1998	2001	PH	33																								
EVASION	1998	2002	PH	33																								
SAXO	1998	2000	PH	33																								
XSARA	1998	2001	PH	33																								
PEUGEOT®	<p>NE78RS2N</p>  <p>Available in Stock</p>	2 Buttons NO battery holder	<table border="1"> <thead> <tr> <th>MODELS</th> <th>YEAR FROM</th> <th>YEAR TO</th> <th>TRANSPONDER TYPE</th> <th>TRP ID</th> </tr> </thead> <tbody> <tr> <td>406</td> <td>2002</td> <td>2004</td> <td>PH / CR2</td> <td>46</td> </tr> <tr> <td>607</td> <td>2004</td> <td>2010</td> <td>PH / CR2</td> <td>46</td> </tr> </tbody> </table>	MODELS	YEAR FROM	YEAR TO	TRANSPONDER TYPE	TRP ID	406	2002	2004	PH / CR2	46	607	2004	2010	PH / CR2	46										
MODELS	YEAR FROM	YEAR TO	TRANSPONDER TYPE	TRP ID																								
406	2002	2004	PH / CR2	46																								
607	2004	2010	PH / CR2	46																								

* The uses of the keys are purely indicative and may be subject to updates and revisions. / Gli utilizzi delle chiavi sono da considerarsi puramente indicativi e possono essere oggetto di aggiornamenti e revisioni. / Die Abbildung und technischen Daten der Schlüssel sind nicht bindend. Silca behält sich Änderungen am Produkt, die zur Verbesserung beitragen, vor. / Les usages des clés sont purement indicatifs; ils peuvent être mis à jour et revus. / Los usos de las llaves deben considerarse puramente indicativos y pueden ser objeto de actualizaciones y revisiones. / As utilizações das chaves devem ser consideradas puramente indicativas e podem ser objecto de actualizações e revisões.

© Registered Trademarks. / © Marchi Registrati. / © Eingetragene Marken. / © Marques Déposées. / © Marcas Registradas. / © Marcas Registradas.



Brand	References/Image	Specifications	Vehicle Models*																									
RENAULT®	<p>VAC102B1N</p>  <p>Available in Stock</p>	1 Button NO battery holder	<table border="1"> <thead> <tr> <th>MODELS</th> <th>YEAR FROM</th> <th>YEAR TO</th> <th>TRANSPONDER TYPE</th> <th>TRP ID</th> </tr> </thead> <tbody> <tr> <td>CLIO</td> <td>1995</td> <td>2001</td> <td>PH</td> <td>33</td> </tr> <tr> <td>KANGOO</td> <td>1998</td> <td>2001</td> <td>PH</td> <td>33</td> </tr> <tr> <td>LAGUNA</td> <td>1995</td> <td>2000</td> <td>PH</td> <td>33</td> </tr> <tr> <td>SAFRANE</td> <td>1995</td> <td>2001</td> <td>PH</td> <td>33</td> </tr> </tbody> </table>	MODELS	YEAR FROM	YEAR TO	TRANSPONDER TYPE	TRP ID	CLIO	1995	2001	PH	33	KANGOO	1998	2001	PH	33	LAGUNA	1995	2000	PH	33	SAFRANE	1995	2001	PH	33
MODELS	YEAR FROM	YEAR TO	TRANSPONDER TYPE	TRP ID																								
CLIO	1995	2001	PH	33																								
KANGOO	1998	2001	PH	33																								
LAGUNA	1995	2000	PH	33																								
SAFRANE	1995	2001	PH	33																								

* The uses of the keys are purely indicative and may be subject to updates and revisions. / Gli utilizzi delle chiavi sono da considerarsi puramente indicativi e possono essere oggetto di aggiornamenti e revisioni. / Die Abbildung und technischen Daten der Schlüssel sind nicht bindend. Silca behält sich Änderungen am Produkt, die zur Verbesserung beitragen, vor. / Les usages des clés sont purement indicatifs; ils peuvent être mis à jour et revus. / Los usos de las llaves deben considerarse puramente indicativos y pueden ser objeto de actualizaciones y revisiones. / As utilizações das chaves devem ser consideradas puramente indicativas e podem ser objecto de actualizações e revisões.

© Registered Trademarks. / © Marchi Registrati. / © Eingetragene Marken. / © Marques Déposées. / © Marcas Registradas. / © Marcas Registradas.

EMPTY KEY SHELLS RANGE

Discover Silca Empty Shells range visiting www.silca.biz and ekc.silca.biz.

Scopri tutta la gamma chiavi Silca Empty Shells collegandoti a www.silca.biz e ekc.silca.biz.

Entdecken sie die Schlüsselpalette Silca Empty Shells auf unseren Websites www.silca.biz und ekc.silca.biz.

Découvrez la notre gamme de clés Silca Empty Shells directement sur notre site www.silca.biz et ekc.silca.biz.

Descubra la gama completa de las llaves Silca Empty Shells visitando www.silca.biz y ekc.silca.biz.

Descubra toda a gama de chaves Silca Empty Shells através dos sitios www.silca.biz e ekc.silca.biz.





The Simpsons™ - 25th Anniversary Collection

THE SIMPSONS™ 25TH ANNIVERSARY COLLECTION

Celebrate with Silca Art Keys the 25th anniversary of the most outrageous family on TV and discover the ten new colourful subjects featuring the most beloved characters from the acclaimed, award-winning animated series. The Simpsons™ keys are a Silca exclusive!

COLLEZIONE THE SIMPSONS™ 25° ANNIVERSARIO

Festeggia con le chiavi Silca Art Keys il 25° anniversario della famiglia più esilarante della TV: The Simpsons™ e scopri i dieci coloratissimi temi con i personaggi più amati dell'acclamata e pluripremiata serie cartoon. Le chiavi The Simpsons™ sono un'esclusiva Silca!

THE SIMPSONS™ JUBILÄUMSEDITION 25 JAHRE

Feiern Sie mit den Silca Art Keys den 25. Jahrestag der lustigsten TV-Familie. Entdecken Sie die zehn neue, bunte Motive der beliebtesten Charaktere aus der gefeierten, preisgekrönten Zeichentrickserie. The Simpsons™ Kollektion gibt es ausschließlich bei Silca!

COLLECTION THE SIMPSONS™ 25ÈME ANNIVERSAIRE

Fêtez avec les clés Silca Art Keys le 25ème anniversaire de la famille plus comique de la télévision et découvrez les dix nouvelles fantaisies colorées avec les personnages les plus aimés et acclamés de ce dessin animé. Les clés The Simpsons™ sont une exclusivité Silca!

COLECCIÓN THE SIMPSONS™ 25° ANIVERSARIO

Celebre con las llaves Silca Art Keys el 25° aniversario de la familia más cómica de la TV y descubre los diez temas de colores vivaces con los personajes más amados de la célebre y multipremiada serie animada. ¡Las llaves The Simpsons™ son una exclusiva Silca!

COLEÇÃO THE SIMPSONS™ 25° ANIVERSÁRIO

Comemore com as chaves Silca Art Keys o 25° aniversário da família mais hilariante da TV e descubra os dez padrões muito coloridos, com as personagens mais amadas da famosa e pluri-galardoada série cartoon. As chaves The Simpsons™ são um exclusivo Silca!



RANGE / GAMMA / PALETTE / GAMME / GAMA

The Simpsons™ - 25th Anniversary Collection is available for the following key references: UL050DC, ASS44, FB13RXL, FB15RXL, FB19RXL, FB20RXL, FB21RL, FB22RL, FB25RL, FB28RL, TE2X, VAC2.

PACKAGING / CONFEZIONE / VERPACKUNG / CONDITIONNEMENT / PAQUETE / EMBALAGEM

Single package. Available in boxes of 10 pieces of the same subject with 2 window stickers inside.
 Confezione singola. Disponibile in scatole da 10 pezzi dello stesso soggetto con all'interno 2 adesivi vetrina.
 Einzeln verpackt. Erhältlich in Kartons zu 10 Stück je Motiv mit 2 Fensteraufklebern.
 Conditionnement individuel. Disponible en boîte de 10 pièces du même sujet avec 2 stickers pour vitrines.
 Paquete de una sola pieza. Disponible en cajas de 10 unidades del mismo sujeto con 2 adhesivos para escaparates.
 Embalagem individual. Disponível em caixas de 10 unidades do mesmo padrão com 2 adesivos para colocar na montra.



THE SIMPSONS™ TM & © 2014 Twentieth Century Fox Film Corporation. All Rights Reserved

More info on all Silca websites



BEST SELLERS 2015 new catalogue and poster

🇬🇧 BEST SELLERS 2015

The "Best Sellers 2015" catalogue, including the most successful subjects of the Art Keys series Nature, Mountain, Puppies, Tropical, Diamond and The Simpsons™, is now available and downloadable from all Silca websites. With these must-have collections your keys offer is truly unique.

🇮🇹 BEST SELLERS 2015

Il catalogo "Best Sellers 2015", che comprende i soggetti più apprezzati delle serie Art Keys Nature, Mountain, Puppies, Tropical, Diamond e The Simpsons™, è ora disponibile su tutti i siti Silca. Rendi unica la tua proposta chiavi con queste imperdibili collezioni.

🇩🇪 BEST SELLERS 2015

Der Katalog "Best Sellers 2015" mit den beliebtesten Motiven der Serie Art Keys Nature, Mountain, Puppies, Tropical, Diamond und The Simpsons™ ist auf allen Silca-Webseiten zum Herunterladen verfügbar. Machen Sie Ihren Schlüsselbund einzigartig mit diesen außergewöhnlichen Kollektionen.

🇫🇷 BEST SELLERS 2015

Le catalogue "Best Sellers 2015" comprenant les thèmes les plus appréciés de la série Art Keys Nature, Mountain, Puppies, Tropical, Diamond et The Simpsons™ est disponible et téléchargeable sur tous les sites Silca. Rendez unique votre proposition clés avec ces collections incontournables.

🇪🇸 BEST SELLERS 2015

El catálogo "Best Sellers 2015", con los sujetos más apreciados de las series Art Keys Nature, Mountain, Puppies, Tropical, Diamond y The Simpsons™, está ahora disponible para descargarlo desde todos los sitios web de Silca. Con estas colecciones imperdibles su propuesta de llaves será única.

🇵🇹 BEST SELLERS 2015

O catálogo "Best Sellers 2015", que abrange os padrões mais apreciados da série Art Keys Nature, Mountain, Puppies, Tropical, Diamond e The Simpsons™, está agora à disposição e pode ser descarregado de todos os sites da Silca. Torne única a sua proposta de chaves com essas coleções imperdíveis.

ART KEYS BEST SELLERS 2015

You can use it as a catalogue (17,5 x 25 cm) or you can unfold it and transform it into a poster (50 x 70 cm). / Puoi utilizzarlo come catalogo (17,5 x 25 cm) oppure aprirlo e trasformarlo in un poster (50 x 70 cm). / Verwenden Sie ihn als Katalog (17,5 x 25 cm) oder öffnen Sie ihn als Poster (50 x 70 cm). / A consulter comme catalogue (17,5 x 25 cm) ou encore à ouvrir et à transformer en poster (50 x 70 cm). / Tiene la opción de consultarlo como un catálogo (17,5 x 25 cm) o bien abrirlo y transformarlo en un póster (50 x 70 cm). / Pode consultá-lo como catálogo (17,5 x 25 cm) ou abri-lo e transformá-lo num cartaz (50 x 70 cm).

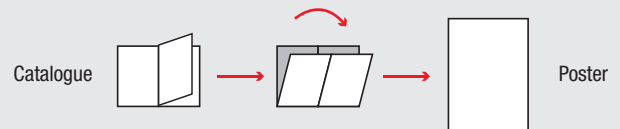

[Click here to download the catalogue](#)

More info on all Silca websites



ON DEMAND 2015 new catalogue

ON DEMAND 2015

The "On Demand" catalogue, including the references that can be ordered from the entire Art Keys range, is now available and downloadable from all Silca websites. Collections included are: Fashion, Fantasy, Flags, Sport, Puppies, Nature, Mountain, Tropical, Diamond and The Simpsons™.

ON DEMAND 2015

Il catalogo "On Demand", che comprende tutte le referenze ordinabili all'interno dell'intera gamma Art Keys, è ora disponibile su tutti i siti Silca. Le collezioni comprese sono: Fashion, Fantasy, Flags, Sport, Puppies, Nature, Mountain, Tropical, Diamond e The Simpsons™.

ON DEMAND 2015

Der Katalog "On Demand" mit allen erhältlichen Artikeln des Art Keys-Vorschlags ist nun auf allen Silca-Webseiten zum Herunterladen verfügbar. Er umfasst die Kollektionen: Fashion, Fantasy, Flags, Sport, Puppies, Nature, Mountain, Tropical, Diamond und The Simpsons™.

ON DEMAND 2015

Le catalogue "On Demand" comprenant toutes les références pouvant être commandées au sein de la gamme Art Keys est maintenant disponible et téléchargeable sur tous les sites Silca. Il inclut les collections: Fashion, Fantasy, Flags, Sport, Puppies, Nature, Mountain, Tropical, Diamond et The Simpsons™.

ON DEMAND 2015

El catálogo "On Demand", con todas las referencias de la gama completa de Art Keys, está ahora disponible y descargable desde todos los sitios web de Silca. Las colecciones incluidas son: Fashion, Fantasy, Flags, Sport, Puppies, Nature, Mountain, Tropical, Diamond y The Simpsons™.

ON DEMAND 2015

O catálogo "On Demand", que abrange todas as referências que podem ser encomendadas dentro da inteira gama Art Keys, está agora à disposição e pode ser descarregado de todos os sites da Silca. As coleções incluídas são: Fashion, Fantasy, Flags, Sport, Puppies, Nature, Mountain, Tropical, Diamond e The Simpsons™.

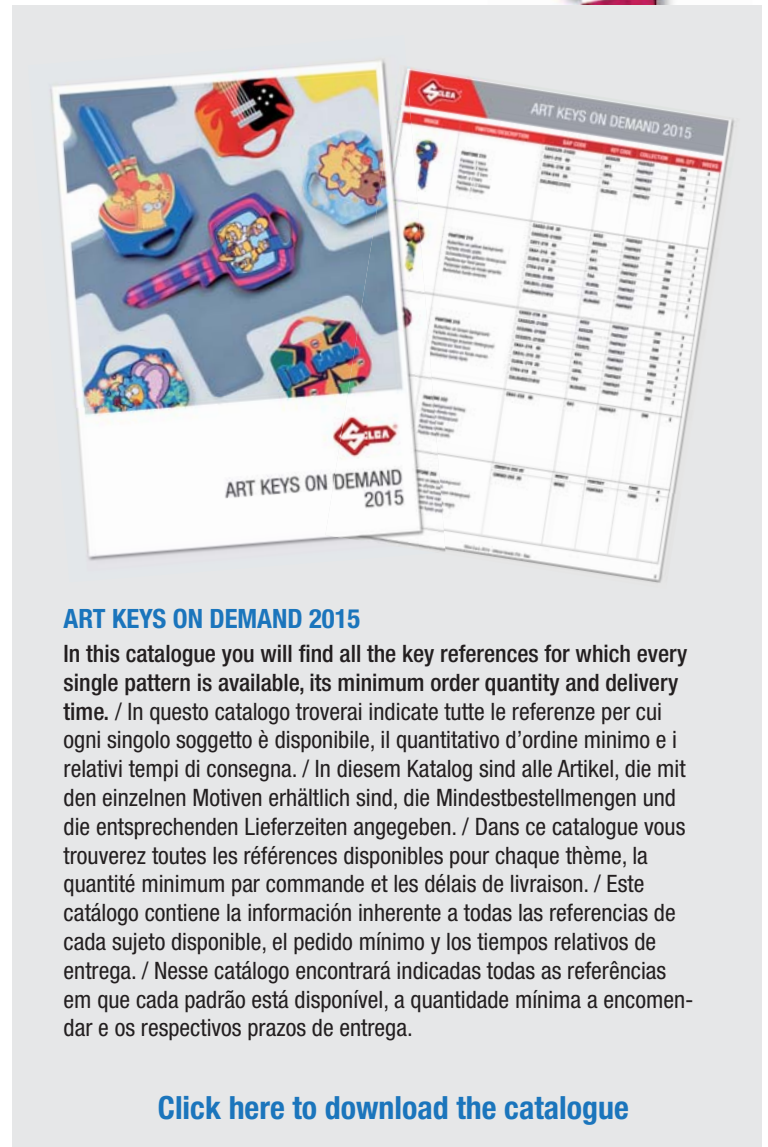

ART KEYS ON DEMAND 2015

In this catalogue you will find all the key references for which every single pattern is available, its minimum order quantity and delivery time. / In questo catalogo troverai indicate tutte le referenze per cui ogni singolo soggetto è disponibile, il quantitativo d'ordine minimo e i relativi tempi di consegna. / In diesem Katalog sind alle Artikel, die mit den einzelnen Motiven erhältlich sind, die Mindestbestellmengen und die entsprechenden Lieferzeiten angegeben. / Dans ce catalogue vous trouverez toutes les références disponibles pour chaque thème, la quantité minimum par commande et les délais de livraison. / Este catálogo contiene la información inherente a todas las referencias de cada sujeto disponible, el pedido mínimo y los tiempos relativos de entrega. / Nesse catálogo encontrará indicadas todas as referências em que cada padrão está disponível, a quantidade mínima a encomendar e os respectivos prazos de entrega.

[Click here to download the catalogue](#)

More info on all Silca websites

MySilca App. Your World at a Fingertip

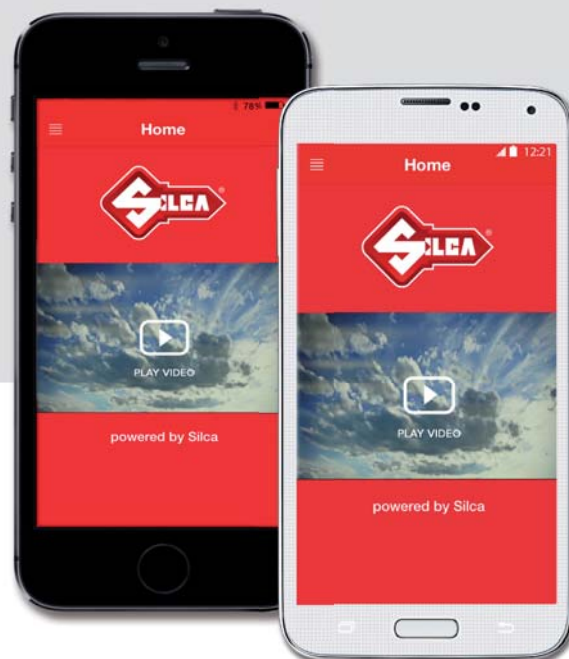

MySilca Comprehensive Products overview

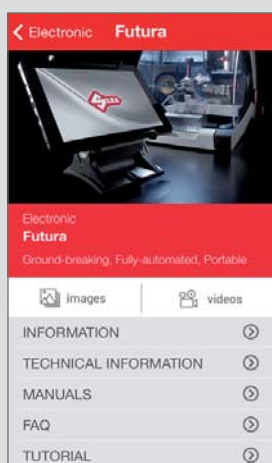

Products

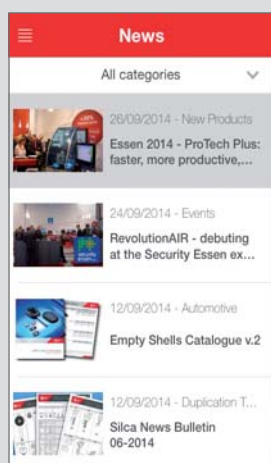

News



Tutorial Video

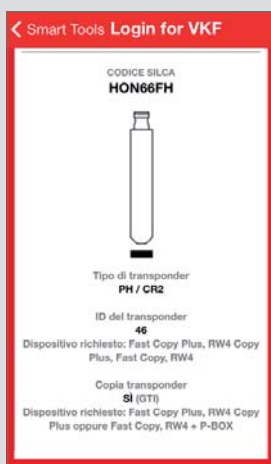

Smart Tools

🇬🇧 MySilca App

With the new app from Silca, you can keep the entire expertise and experience of your Key Partner at hand, anytime, anywhere. Plenty exclusive contents will be easily accessible from your smart phone to provide you updates and support in your daily activities.

- ✔ Available for **iOs and Android**.
- ✔ Downloadable from **Google Play or App Store for free**.
- ✔ **Push notifications alert** you in real time that updates and new products have been released.
- ✔ Overview of the **top-notch products** with comprehensive and easy to consult contents: leaflets, manuals, video tutorials, FAQs.
- ✔ Smart tools: the **Electronic Key Catalogue** and the **Vehicle Key Finder** have been integrated in the app to grant you prompt access to the most extensive key database in the world and guide you through the duplication of vehicle keys.
- ✔ **Multilingual**: available in English, Italian, German, French, Spanish, Portuguese and Dutch.

🇮🇹 MySilca App

Con la nuova app di Silca tutta l'informazione e l'esperienza del tuo Partner Chiave sarà a portata di mano, sempre e dovunque. Numerosi i contenuti esclusivi accessibili direttamente dal tuo smartphone per fornirti aggiornamenti e supporto quotidiano alla tua attività.

- ✔ Disponibile per i sistemi **iOs e Android**.
- ✔ Scaricabile gratuitamente da **Google Play o App Store**.
- ✔ Tutti gli aggiornamenti e i nuovi prodotti Silca segnalati in tempo reale **con notifiche push**.
- ✔ **Panoramica dei prodotti di punta** con contenuti esaustivi e facilmente consultabili: schede prodotto, manuali, video tutorial, FAQ.
- ✔ Smart tools: il **Catalogo Elettronico Chiavi** e il **Vehicle Key Finder** sono integrati nell'app per permetterti di accedere con immediatezza al database chiavi più completo al mondo e guidarti nella duplicazione delle chiavi veicolo.
- ✔ **Multilingua**: disponibile in inglese, italiano, tedesco, francese, spagnolo, portoghese e olandese.

More info on all Silca web sites



MySilca App, Your World at a Fingertip

MySilca App

Mit der neuen App der Silca haben Sie alle Informationen und die Erfahrung Ihres Key Partners immer und überall dabei. Aktuelle Informationen und Support für Ihre alltägliche Arbeit durch direkten Zugriff über Ihren Smartphone auf exklusive Inhalte.

- ✔ Für **iOs** und **Android-Systeme** erhältlich
- ✔ Kostenloser Download von **Google Play** oder **App Store**.
- ✔ Alle Updates und neue Silca-Produkte mit **Push-Benachrichtigungen** in Echtzeit gemeldet.
- ✔ **Überblick über die Spitzenprodukte** mit ausführlichem Inhalt, leicht zugänglich: Datenblätter, Handbücher, Tutorfilme, FAQ.
- ✔ Smart tools: der **Elektronische Schlüsselkatalog** und der **Vehicle Key Finder** sind in der App integriert, damit Sie sofort auf die weltweit größte Schlüssel-Datenbank zugreifen können und bei der Duplikation der Fahrzeugschlüssel geführt werden können.
- ✔ **Mehrsprachig:** in Englisch, Italienisch, Deutsch, Französisch, Spanisch, Portugiesisch und Niederländisch verfügbar.

MySilca App

Con la nueva app de Silca tendrá toda la información y la experiencia de Silca, su Socio Llave, siempre al alcance y en todas partes. Numerosos contenidos exclusivos accesibles desde su smartphone para proporcionarle actualizaciones y convertirse en un apoyo diario de su actividad.

- ✔ Disponible para los sistemas **iOs y Android**.
- ✔ Descargas gratis en **Google Play o App Store**.
- ✔ Avisos en tiempo real de todas las actualizaciones y los nuevos productos Silca mediante **notificaciones push**.
- ✔ **Panorámica de los productos punteros** con contenidos exhaustivos y fáciles de consultar: fichas de productos, manuales, vídeo tutorial, preguntas frecuentes.
- ✔ Smart tools: el **Catálogo Electrónico Llaves** y el **Vehicle Key Finder** están integrados en la app para acceder inmediatamente a la base de datos de llaves más completa del mundo y guiarle en la duplicación de las llaves de vehículos.
- ✔ **Multilingüe:** disponible en inglés, italiano, alemán, francés, español, portugués y holandés.

MySilca App

Grâce à la nouvelle app Silca, toutes les informations et l'expérience de votre Partenaire Clés sera à portée de la main toujours et partout. De nombreux contenus exclusifs sont accessibles directement sur votre Smartphone pour vous fournir les mises à jour et les soutiens quotidiens de votre travail.

- ✔ Disponible pour les systèmes **iOs et Android**.
- ✔ Téléchargeables gratuitement sur **Google Play ou App Store**.
- ✔ Toutes les mises à jour et les nouveaux produits Silca communiqués en temps réel **via des avis push**.
- ✔ **Aperçu des produits de pointe** aux contenus exhaustifs et facilement consultables: fiches produit, manuels, vidéos tutorielles, FAQ.
- ✔ Smart tools: notre **Catalogue Électronique Clés** et **Vehicle Key Finder** sont intégrés dans l'app pour vous permettre d'accéder immédiatement au data base clés le plus complet du monde et vous guider dans la reproduction de clés pour véhicules.
- ✔ **Multilingue:** disponible en anglais, italien, allemand, français, espagnol, portugais et néerlandais.

MySilca App

Com a nova aplicação da Silca todas as informações e a experiência do seu Parceiro Chave estarão ao alcance da mão, sempre e em qualquer lugar. Os conteúdos a que pode ter acesso directamente do seu smartphone são muitos, para fornecer actualizações e suporte no dia a dia da sua actividade.

- ✔ Disponível para os sistemas **iOs e Android**.
- ✔ Download gratuito de **Google Play ou App Store**.
- ✔ Todas as actualizações e os novos produtos Silca são assinalados em tempo real **com notificações push**.
- ✔ **Panorâmica dos produtos em destaque** com conteúdos exhaustivos e de fácil consulta: fichas produto, manuais, vídeos tutoriais, FAQ.
- ✔ Smart tools: o **Catálogo Electrónico Chaves** e o **Vehicle Key Finder** são integrados na aplicação para lhe permitir acesso imediato à base de dados mais completa do mundo e para o assistir na duplicação das chaves para veículo.
- ✔ **Multilingua:** disponível em inglês, italiano, alemão, francês, espanhol, português e holandês.

Download MySilca from

Scarica MySilca da / Download MySilca von / Télécharger MySilca de /
Descargue MySilca de / Descarregar MySilca de



More info on all Silca web sites

ELECTRONIC KEY CATALOGUE Comparative Key Update



🇬🇧 UPDATED COMPARATIVE REFERENCES

The comparative references of the Silca Electronic Key Catalogue have been updated. With EKC you can easily get the Silca reference corresponding to a key by another brand and search through the most extensive key database in the world.

🇮🇹 AGGIORNAMENTO CODICI COMPARATIVI

I codici comparativi del Catalogo Elettronico Chiavi sono stati aggiornati. Con EKC puoi facilmente accedere alla referenza Silca corrispondente alla chiave di un altro marchio ed effettuare ricerche all'interno del database chiavi più esteso al mondo.

🇩🇪 AKTUALISIERUNG VERGLEICHS-ARTIKELNR.

Die Aktualisierung der Vergleichs-Artikelnummer des Elektronischen Schlüsselkatalogs ist verfügbar. Mit EKC haben Sie leichten Zugriff auf die Silca-Artikelreferenz, die dem Schlüssel eines Mitbewerbers entspricht und können in der umfassendsten Datenbank der Welt nachsuchen.

🇫🇷 MISE À JOUR CODES COMPARATIFS

Les références comparatives du Catalogue Electronique Clés ont été mises à jour. Grâce à EKC, vous pourrez facilement accéder à la référence Silca correspondant à la clé d'une autre marque et lancer une recherche au sein du data base clés le plus vaste du monde.

🇪🇸 ACTUALIZACIÓN CÓDIGOS COMPARATIVOS

Los códigos comparativos del Catálogo Electrónico Llaves se han actualizado. EKC le permite acceder fácilmente a la referencia Silca correspondiente a la llave de otra marca y efectuar búsquedas en la base de datos de llaves más grande del mundo.

🇵🇹 ATUALIZAÇÃO CÓDIGOS COMPARATIVOS

Os códigos comparativos do Catálogo Electrónico Chaves foram atualizados. Com EKC pode ter acesso facilmente à referência Silca que corresponde à chave de uma outra marca e efectuar pesquisas na base de dados mais rica no mundo.

Customized key tags print out

🇬🇧 CUSTOMIZED KEY TAGS

With Silca EKC you can print out customized key tags by selecting the print options of your interest, such as comparative references, vehicle makes, prices or other personal information of your choice.

🇩🇪 INDIVIDUALISIERTEN LEITKARTEN

Mit Silca EKC können Sie Ihre Leitkarten durch die gewünschten Druckoptionen wie Vergleichs-Artikelnummer, Fahrzeugmarke, Preis oder weitere persönliche Anmerkungen individuell gestalten.

🇪🇸 ETIQUETAS PERSONALIZADAS

Silca EKC le permite personalizar sus etiquetas mediante la selección de las opciones de imprimir de su interés: códigos comparativos, marcas del vehículo, precio y otras anotaciones personales de su elección.

🇮🇹 BINDELLI PERSONALIZZATI

Con Silca EKC puoi personalizzare i tuoi bindelli selezionando le opzioni di stampa di tuo interesse, come codici comparativi, marche veicolo, prezzo e altre annotazioni personali a tua scelta.

🇫🇷 ÉTIQUETTES PERSONALISÉES

Avec Silca EKC, vous pourrez personnaliser les étiquettes de vos crochets en sélectionnant les options d'impression vous agréant comme les codes comparatifs, les marques véhicule, les prix et autres remarques personnelles à votre gré.

🇵🇹 ETIQUETAS PERSONALIZADAS

Com Silca EKC pode personalizar as suas etiquetas seleccionando as opções de impressão que lhe interessam, como códigos comparativos, marcas de veículo, preço ou outras anotações pessoais preferidas.

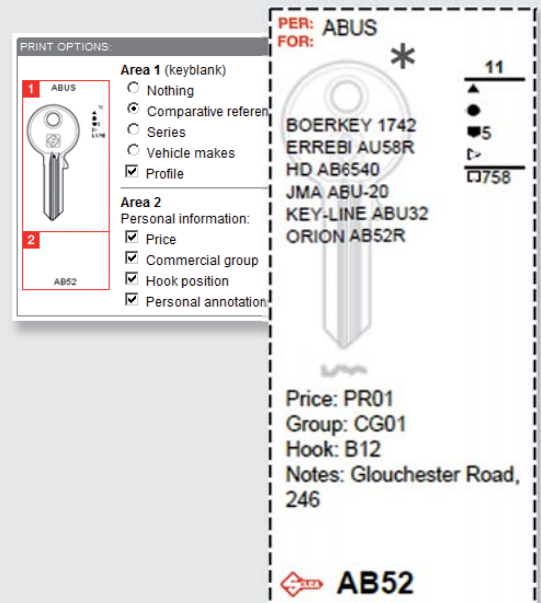

Register on ekc.silca.biz. It's free!



SILCA KEY PROGRAMS UPDATE 2/2014



SILCA KEY PROGRAMS Update 2/2014

www.silca.biz

SILCA KEY PROGRAMS - Update 2/2014

New Silca Key Programs 2/2014 Update for all WEB and DVD subscribers available on the "News" section of Silca Key Programs. Discover all the updates for Silca Code Program, Silca Triax and Quattrocode Program, Silca Viper Program and Futura.

SILCA KEY PROGRAMS - Aktualisierung 2/2014

Die **neue Aktualisierung Silca Key Programs 2/2014** für alle WEB und DVD Abonnenten ist in der Sektion "Neuheiten" des Silca Key Programs verfügbar. Entdecken Sie die Aktualisierungen für Silca Code Program, Silca Triax und Quattrocode Program, Silca Viper Program und Futura.

SILCA KEY PROGRAMS - Actualización 2/2014

Nueva actualización Silca Key Programs 2/2014 para todos los abonados WEB y DVD disponible en la sección "Novedades" de Silca Key Programs. Descubra todas las actualizaciones para Silca Code Program, Silca Triax y Quattrocode Program, Silca Viper Program y Futura.

SILCA KEY PROGRAMS - Aggiornamento 2/2014

Nuovo Aggiornamento Silca Key Programs 2/2014 per tutti gli abbonati WEB e DVD consultabile nella sezione "Novità" di Silca Key Programs. Scopri tutti gli aggiornamenti per Silca Code Program, Silca Triax e Quattrocode Program, Silca Viper Program e Futura.

SILCA KEY PROGRAMS - Mise à jour 2/2014

Nouvelle mise à jour Silca Key Programs 2/2014 pour tous les abonnés WEB et DVD disponible dans la section "Nouveautés" de Silca Key Programs. Découvrez toutes les mises à jour pour Silca Code Program, Silca Triax et Quattrocode Program, Silca Viper Program et Futura.

SILCA KEY PROGRAMS - Atualização 2/2014

Nova atualização Silca Key Programs 2/2014 para todos o assinantes WEB e DVD disponível na seção "Novedades" de Silca Key Programs. Descubra todas as atualizações para Silca Code Program, Silca Triax e Quattrocode Program, Silca Viper Program e Futura.

More info on all Silca websites



SILCA CODE PROGRAM - UPDATES

70 new data cards



Unocode 199



Unocode 299/399



Unocode 399 Evo

Silca has introduced a new cutting method known as NORMAL EASY for standard car and door keys. This method can be selected on many data cards instead of the Normal, Flat or Laser method to reduce cutting vertices and make the key slide more smoothly in the cylinder. On key cutting machines select cutting method X. In Silca Key Programs select the NORMAL EASY cutting method.

Silca hat die neue Fräsmethode NORMAL EASY für Standardschlüssel für Fahrzeuge und Türen eingeführt. Diese Methode kann auf sehr vielen Datenkarten anstelle der Methode Normal, Flach oder Laser ausgewählt werden, damit die Frässpitzen verringert werden und die Schlüssel leichter in den Zylinder gleiten. In den Schlüsselfräsmaschinen die Fräsmethode X auswählen. In Silca Key Programs die Fräsmethode NORMAL EASY auswählen.

Silca ha introducido un nuevo método de corte para llaves estándares vehículo y puerta llamado NORMAL EASY. Este método puede seleccionarse en muchísimas fichas en lugar del método Normal, Plano o Láser para reducir los vértices de cifrado y para que la llave deslice mejor en el cilindro. En las duplicadoras seleccionar el método de corte X. En el Silca Key Programs seleccionar el método de corte NORMAL EASY.

Silca ha introdotto un nuovo metodo di taglio per chiavi standard auto e porta denominato NORMAL EASY. Questo metodo può essere selezionato in moltissime schede al posto del metodo Normale, Piano o Laser per ridurre i vertici di cifratura e rendere la chiave più scorrevole nel cilindro. Nelle duplicatrici selezionare metodo di taglio: X. Nel Silca Key Programs selezionare metodo di taglio NORMAL EASY.

Silca a ajouté une nouvelle méthode de taillage appelée NORMAL EASY pour les clés standard auto et de porte. Cette méthode peut être sélectionnée dans plusieurs cartes en plus des méthodes Normal, Plate et Laser pour réduire les pointes de tailles et faire la clé. Sur la machine à tailler les clés sélectionné la méthode de taille: X. Dans le Silca Key Program sélectionné la méthode de taille NORMAL EASY.

A Silca introduziu um novo método de corte para chaves standard para automóvel e porta denominado NORMAL EASY. Este método pode ser selecionado em muitas fichas em lugar do método Normal, Plano ou Laser para reduzir os vértices de corte e fazer com que a chave deslize melhor no cilindro. Nas máquinas duplicadoras seleccionar o método de corte: X. No Silca Key Programs seleccionar o método de corte NORMAL EASY.



Data update with 70 new data cards / Aggiornamento dati con 70 nuove schede / Datenaktualisierung mit 70 neuen Karten / Mise à jour des données avec 70 fiches / Actualización datos con 70 fichas nuevas / Atualização dados com 70 fichas novas

New items include / Tra le novità / Unter den Neuheiten / Parmi les nouveautés / Entre las novedades / Entre as novidades:

- | | | |
|-------------------------------|----------------------------------|------------------------------------|
| - ABUS® - Abus NW52 | - GUARD® - Profile G11 | - KABA® - Kaba Peaks A4 (0.140") |
| - ABUS® - Abus NW72 | - GUARD® - Profile G12 | - RUKO® - Triton - 501 |
| - ASSA® - Neptun | - GUARD® - Profile G13 | - RUSSWIN® - Russwin 981 Class |
| - ASSA_TRI® - Triton 5900 | - GUARD® - Profile G14 | - RUSSWIN® - Russwin 752-Old |
| - BASI® - Ap pro | - GUARD® - Profile G17 | - RUSSWIN® - Russwin 852 Class-Old |
| - Best® - System: A3 | - HUGO® - GR 2.55 | - STAHLEX® - Starry |
| - CES® - CES PSM-UDM | - KABA® - Kaba Peaks A2 (0.150") | - TRIO-VING® - Triton |
| - FEDERAL® - HS3 | - KABA® - Kaba Peaks A2 (0.140") | |
| - GUARD® - Profile EPS/P EP83 | - KABA® - Kaba Peaks A4 (0.150") | |

Update the software on UC199, UC299, UC399 and UC399 EVO. / Aggiornare il software di UC199, UC299, UC399 e UC399 EVO. / Aktualisierung der Software von UC199, UC299, UC399 und UC399 EVO. / Mettre à jour le logiciel de UC199, UC299, UC399 et UC399 EVO. / Actualizar el software de UC199, UC299, UC399 y UC399 EVO. / Atualizar o software de UC199, UC299, UC399 e UC399 EVO.



Silca Key Programs

Update 2/2014

SKP Update Version 20.4.x.xx

NEW

SILCA TRIAX - QUATTROCODE PROGRAM - UPDATES

31 new series



Triax-e.code

Triax Quattro



Quattrocode

Data update with 31 new series / Aggiornamento dati con 31 nuove serie / Datenaktualisierung mit 31 neuen Serien / Mise à jour des données avec 31 séries / Actualización datos con 31 nuevas series / Atualização dados com 31 novas séries

New items include / Tra le novità / Unter den Neuheiten / Parmi les nouveautés / Entre las novedades / Entre as novidades:

- ABUS® Bravus 3000 - Tip stop
- ATRA® New Power (7W-2P) - Padronale
- ATRA® New Power (7W-2P) - No Padronale
- CISA® AP3 PP solo attive
- DOM® IXSATS (Precoded)
- DOM® IXSATS (Prof. 169)
- DOM® IXSATS (Prof. 170)
- DOM® IXSATS (Prof. 171)
- DOM® IXSATS (Prof. 172)
- GARDESA® Tiger-Lion
- ISEO® R9 Country cantiere
- ISEO® R9 Country padronale
- KABA® ExperT S 1.2a - Swedish market
- M&C® Color Modulair (3+3)
- M&C® Color Modulair (3+3) (2T-3W)
- MAUER® ML+
- RB-LOCKS® Lockxis
- TOYOTA® Emergency key

Update the software on TRIAX-e.code and TRIAX QUATTRO. / Aggiornare il software di TRIAX-e.code e TRIAX QUATTRO. / Aktualisierung der Software von TRIAX-e.code und TRIAX QUATTRO. / Mettre à jour le logiciel de TRIAX-e.code et TRIAX QUATTRO. / Actualizar el software de TRIAX-e.code y TRIAX QUATTRO. / Atualizar o software de TRIAX-e.code e TRIAX QUATTRO.

NEW

SILCA VIPER PROGRAM - UPDATES

2 new series



Viper

Data update with 2 new series / Aggiornamento dati con 2 nuove serie / Datenaktualisierung mit 2 neuen Serien / Mise à jour des données avec 2 séries / Actualización datos con 31 nuevas series / Atualização dados com 2 novas séries

New items include / Tra le novità / Unter den Neuheiten / Parmi les nouveautés / Entre las novedades / Entre as novidades:

- TOYOTA® Emergency key
- TOYOTA® Valeo (2T - 8W)

Update the software on VIPER. / Aggiornare il software di VIPER. / Aktualisierung der Software von TVIPER. / Mettre à jour le logiciel de VIPER. / Actualizar el software de VIPER. / Atualizar o software de VIPER.

NEW

FUTURA PROGRAM - UPDATES

new software version



Futura

The Futura software has been updated to version 2.5.0. / Il software di Futura è stato aggiornato alla versione 2.5.0. / Die Futura-Software wurde auf Version 2.5.0 aktualisiert. / Le logiciel Futura a été mis à jour à la version 2.5.0. / El software Futura ha sido actualizado a la versión 2.5.0. / O software Futura foi atualizado para a versão 2.5.0.

Check out the "Futura" page on the Silca site to know more.
 Consulta il sito Silca alla pagina "Futura" per saperne di più.
 Sehen Sie die Seite "Futura" auf Silca Website, um weitere Informationen zu finden.
 Consultez la page "Futura" sur notre site Silca pour en savoir plus.
 Visite la página "Futura" en el sitio Silca para más informaciones.
 Consulte a página "Futura" no site Silca para saber mais.

FOR:
PER: **ABUS (D)**

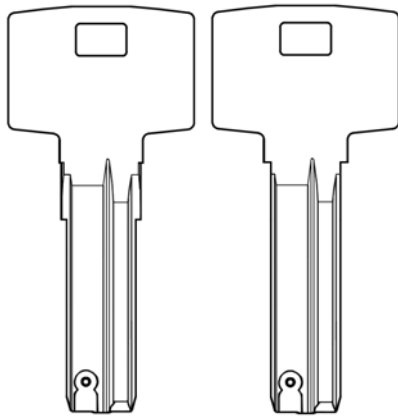

"OLD" "NEW" *

Bravus

(1000 - 2000 - 3000 - 4000)

System protected by a password issued by Silca on receipt of authorization.

Sistema protetto da password rilasciata da Silca a fronte di autorizzazione.

System geschützt durch von Silca geliefertes Password auf Genehmigung.

Système protégé par un password qui est émis par Silca sur autorisation.

Sistema protegido por password que expide Silca contra autorización.

Sistema protegido por uma password emitida por Silca contra a autorização.



**TRIAX QUATTRO
TRIAX-E.CODE**

OPTIONAL



R109 > December 2014

D742701ZB

- R109 clamp
- Morsetto R109
- Spannbacke R109
- Etau R109
- Mordaza R109
- Mordente R109

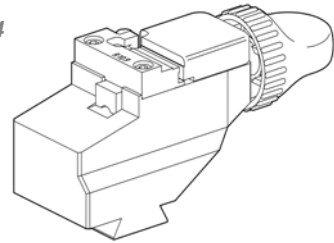

(* for R109 < December 2014

D942702ZR

- R109 jaws set
- Set ganasce per R109
- Backensatz für R109
- Ens.mâchoires pour R109
- Set quijadas para R109
- Garras para R109

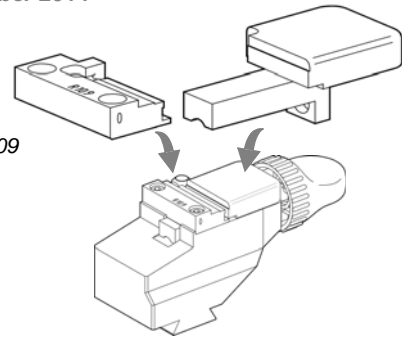

OPTIONAL

1000 - 2000 - 3000 systems

D710776ZB

- Cutter W205
- Fresa W205
- Fräser W205
- Fraise W205
- Fresa W205
- Fresa W205



4000 system

D710776ZB

- Cutter W205
- Fresa W205
- Fräser W205
- Fraise W205
- Fresa W205
- Fresa W205



D742700ZB

- Cutter W317
- Fresa W317
- Fräser W317
- Fraise W317
- Fresa W317
- Fresa W317

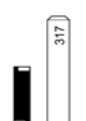

FOR:
PER: **TOYOTA (J)**

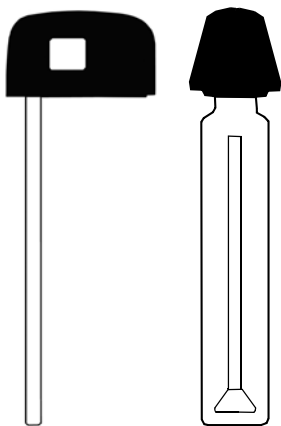

(Emergency key)

LEXUS



VIPER

OPTIONAL

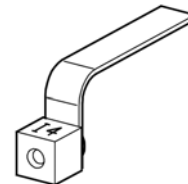

D744515ZB

- Adapter I4 for TOYOTA LEXUS keys (Emergency key)
- Adattatore I4 per chiavi TOYOTA LEXUS (Emergency key)
- Adapter I4 für TOYOTA LEXUS Schlüssel (Emergency key)
- Adaptateur I4 pour clés TOYOTA LEXUS (Emergency key)
- Adaptador I4 para llaves TOYOTA LEXUS (Emergency key)
- Adaptador I4 para chaves TOYOTA LEXUS (Emergency key)

SW Viper 1.2.024 DB 15.00

Starting from SKP Software version 20.4.0.54
Dalla versione Software SKP 20.4.0.54
Ab SKP Software Version 20.4.0.54
À partir du software SKP version 20.4.0.54
Desde software SKP versión 20.4.0.54
A partir da versão software SKP 20.4.0.54

Delivery time JANUARY 2015
Disponibilità GENNAIO 2015
Lieferbar JANUAR 2015
Disponibilité JANVIER 2015
Disponibilidad ENERO 2015
Disponibilidade JANEIRO 2015