



108 Catalogue Update



Update to 108 keys catalogue:

Key catalogue for household and commercial flat,
cruciform, lift and mail box keys

Aggiornamento al catalogo chiavi 108:

Chiavi piatte per serrature a cilindro,
chiavi a croce, chiavi per ascensori e casellari postali

Aktualisierung des Schlüssellkataloges 108:

Flach-und Kreuzbartschlüssel,
Fachkasten-und Liftschlüssel Katalog

Mise à jour du catalogue clés 108:

Catalogue clés plates pour cylindres,
clés cruciformes, clés pour ascenseurs et casiers

Actualización del catálogo llaves 108:

Catálogo llaves planas para cilindro, llaves en cruz,
llaves para casillas y ascensores

Atualização do catálogo chaves 108:

Catálogo das chaves planas para fechaduras de cilindro,
chaves tetra, chaves para elevadores e caixas de correio

Upgrade sleutelcatalogus 108:

Catalogus voor huissleutels, cilindersleutels, kruisvormige sleutels en
sleutels voor liften en brievenbussen

108 Catalogue Update

108 Catalogue Update



Silca Library	IV
Glossary	VI
Key identification	VIII
Uses	IX
Technical information	X
Serie Distinzione heads	XIII

Cylinder lock keys	1
General index	25



Datenarchiv Silca	IV
Terminologie	VI
Schlüsselidentifikation	VIII
Verwendungen	IX
Technische Auskünfte	X
Schlüsselköpfe der Serie "Distinzione"	XIII

Zylinderschlüssel	1
Generalverzeichnis	25



Libreria Silca	IV
Terminologia	VI
Identificazione chiave	VIII
Utilizzi	IX
Informazioni tecniche	X
Teste Serie Distinzione	XIII

Chiavi piatte per serrature a cilindro	1
Indice generale	25



Bibliothèque Silca	IV
Terminologie	VI
Identification clé	VIII
Utilisations	IX
Informations techniques	X
Têtes série Distinction	XIII

Clés plates pour serrures a cylindre	1
Index général	25



Librería Silca	IV
Terminología	VI
Identificación de la llave	VIII
Utilizaciones	IX
Informaciones técnicas	X
Cabezas Serie Distinzione	XIII

Llaves planas para cerraduras a cilindro	1
Índice general	25



Silca Bibliotheek	IV
Terminologie	VI
Sleutelidentificatie	VIII
Toepassingen	IX
Technische informatie	X
Koppen Serie Distinzione	XIII

Cilinderslotsleutels	1
Allgemene Index	25



Livraria Silca	IV
Terminologia	VI
Identificação de uma chave	VIII
Utilizações	IX
Informações técnicas	X
Cabeças Serie Distinzione	XIII

Chaves planas para fechaduras de cilindro	1
Índice geral	25

108 Catalogue Update



108 CATALOGUE

MONTHLY SILCA NEWS BULLETINS

108 CATALOGUE UPDATE



SILCA LIBRARY

The new Catalogue 108 Update completes and updates the range of flat keys for cylinder locks, cruciform keys, lift and mailbox keys presented in the 108 Catalogue.

This catalogue includes all the new keys launched by Silca since October 2013 and a range of key references that, due to popular request, has been reinstated. These keys are easily identifiable thanks to the specific symbol used.

To keep up-to-date with Silca latest news don't miss the Silca News Bulletins, published on a monthly basis and downloadable from the Catalogue section of www.silca.biz.

All our new products are always accessible online via smartphone and tablet through a number of useful applications, such as MySilca App, Silca EKC (Electronic Key Catalogue) and Vehicle Key Finder Pro.



LIBRERIA SILCA

Il nuovo Catalogo 108 Update completa e aggiorna la gamma di chiavi piatte per serrature a cilindro, chiavi a croce, per ascensori e casellari postali già presente nel Catalogo 108.

In questo catalogo sono raccolte tutte le nuove chiavi Silca lanciate a partire da ottobre 2013 e, a grande richiesta del mercato, è stata ripristinata e riattivata una gamma di referenze, facilmente identificabili grazie alla simbologia utilizzata.

Per essere sempre aggiornato con le ultime novità Silca non perdere i Bollettini Silca News, pubblicati mensilmente e scaricabili dal sito www.silca.biz nella sezione Cataloghi.

Tutte le nostre novità di prodotto sono sempre accessibili online tramite smartphone e tablet grazie agli applicativi MySilca App, Silca EKC (Catalogo Elettronico Chiavi) e Vehicle Key Finder Pro.



DATENARCHIV SILCA

Der neue Katalog 108 Update vervollständigt und aktualisiert das Sortiment der Flachschlüssel für Zylinderschlösser, der Kreuzbartschlüssel, der Fachkasten- und Liftschlüssel des Katalogs 108.

Dieser Katalog umfasst alle neuen Schlüssel, die Silca ab Oktober 2013 auf den Markt gebracht hat und aufgrund der großen Nachfrage sind auch wieder Referenzschlüssel aktiviert und eingeführt worden, die dank der verwendeten Zeichen, leicht erkennbar sind.

Verpassen Sie die Neuheiten von Silca nicht, bleiben Sie immer auf den neusten Stand mit den monatlich veröffentlichten Silca News, die Sie auf der Webseite www.silca.biz im Bereich Kataloge herunterladen können.

Mit MySilca, Silca EKC (Elektronischer Schlüsselkatalog) und Vehicle Key Finder Pro haben Sie über Ihren Smartphone oder Tablet immer Zugriff online auf unsere Produktneuheiten.



BIBLIOTHÈQUE SILCA

Notre nouveau Catalogue 108 Update complète et met à jour la gamme de clés plates pour serrures à cylindre, clés croix, pour ascenseurs et boîtes aux lettres répertoriée dans notre Catalogue 108.

Nous recueillons dans ce catalogue toutes les nouvelles clés Silca lancées à partir d'octobre 2013 et, sur demande pressante du marché, nous avons restauré et remis en service une gamme d'articles facilement identifiables grâce au symbole utilisé.

Pour être toujours à jour avec les dernières nouveautés Silca, ne ratez pas nos Bulletins Silca News mensuels que vous pourrez télécharger sur notre site www.silca.biz dans la section Catalogues.

Toutes les nouveautés sur nos produits sont toujours accessibles en ligne via smartphone et tablette grâce aux applications MySilca App, Silca EKC (Catalogue Électronique Clés) et Vehicle Key Finder Pro.



SILCA ELECTRONIC KEY CATALOGUE

SILCA WEB SITES

MYSILCA APP

VEHICLE KEY FINDER PRO



LIBRERÍA SILCA

El nuevo Catálogo 108 Update completa y actualiza la gama de llaves planas para cerraduras de cilindro, llaves en cruz, para ascensores y casilleros postales, contenida en el Catálogo 108.

Este catálogo contiene todas las llaves nuevas de Silca, lanzadas a partir del mes de octubre de 2013 y, por una gran demanda del mercado, se ha restablecido y reactivado una gama de referencias, fácilmente identificables mediante los símbolos usados.

Para estar siempre al día sobre las últimas novedades Silca no se pierda los Boletines Silca News, publicados mensualmente y disponibles para la descarga en la web www.silca.biz en la sección Catálogos.

Todas nuestras novedades de producto están siempre accesibles online usando un smartphone o una tableta mediante las aplicaciones MySilca App, Silca EKC (Catálogo electrónico llaves) y Vehicle Key Finder Pro.



SILCA BIBLIOTHEEK

De nieuwe Catalogus 108 Update vervolledigt en updatet het gamma vlakke sleutels voor cilindersloten en kruisbaardsleutels voor liften en brievenbussen aanwezig in de Catalogus 108.

Deze catalogus vermeldt alle nieuwe Silca sleutels die gelanceerd werden vanaf oktober 2013. Op uitdrukkelijk verzoek van de markt werden een aantal artikels, makkelijk identificeerbaar via de gebruikte symbolen, terug ingevoerd.

Raadpleeg onze "Silca News" nieuwsbrief, maandelijks gepubliceerd en downloadbaar op onze site www.silca.biz in de sectie Catalogi, om steeds op de hoogte te zijn van de allernieuwste Silca trends.

Je kan steeds met je smartphone of tablet alle nieuwigheden over onze producten online raadplegen dankzij de app's MySilca, Silca EKC (Elektronische Sleutelcatalogus) en Vehicle Key Finder Pro.



LIVRARIA SILCA

O novo Catálogo 108 Update completa e actualiza a gama de chaves planas para fechaduras de cilindro, chaves tetra, para elevadores e caixas de correio já presente no Catálogo 108.

Neste catálogo estão reunidas todas as chaves Silca novas lançadas a partir de outubro de 2013 e, pelo grande pedido do mercado, foi restabelecida e reactivada uma gama de referências, que pode ser facilmente identificada graças aos símbolos utilizados.

Para estar sempre actualizado com as últimas novidades Silca, não perca os Boletins Silca News, que são publicados mensalmente e que podem ser descarregados do site www.silca.biz na secção Catálogos.

É possível ver sempre online todos os nossos produtos novidade através de smartphone e tablet graças às aplicações MySilca App, Silca EKC (Catálogo Electrónico Chaves) e Vehicle Key Finder Pro.

Silca Library

108 Catalogue Update

GLOSSARY - TERMINOLOGIA - TERMINOLOGIE - TERMINOLOGIE - TERMINOLOGIA - TERMINOLOGIA - TERMINOLOGIE

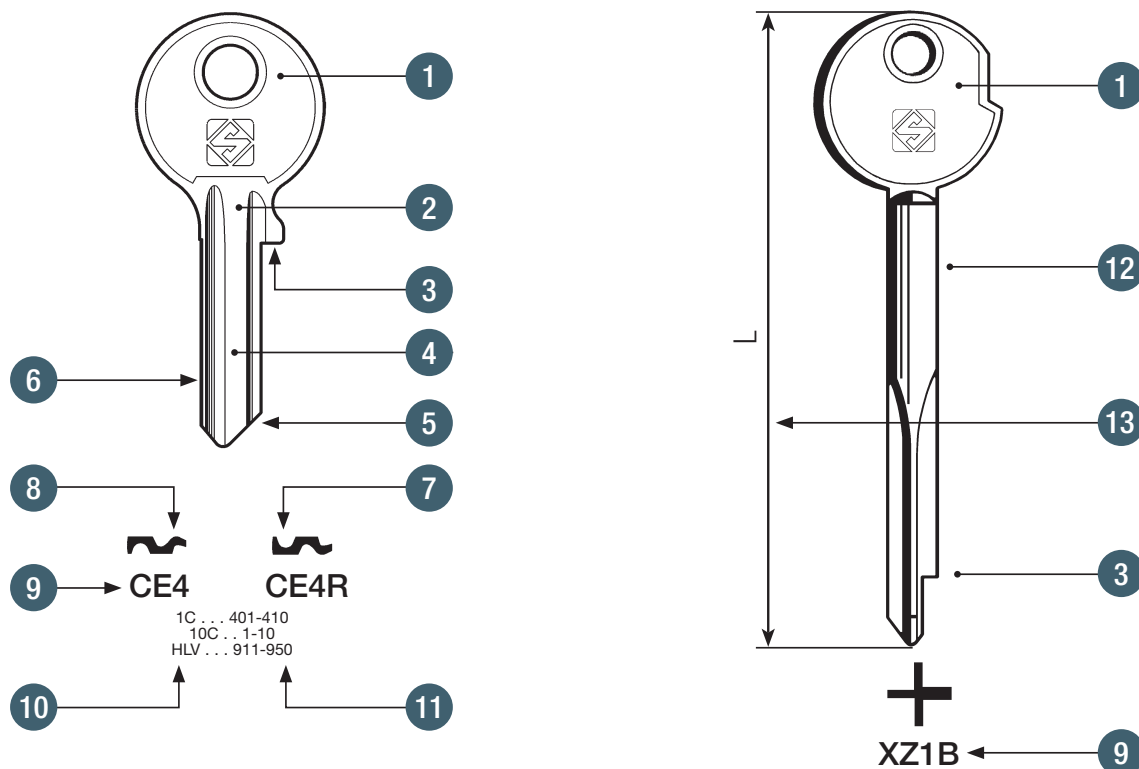

1	Head	Testa	Kopf	Tête	Cabeza	Cabeça	Kop
2	Neck	Collo	Hals	Cou	Cuello	Colo	Hals
3	Shoulder	Fermo	Anschlag	Arrêt	Tope	Encosto	Aanslag
4	Blade (stem)	Canna	Stange	Canon	Caña	Cana	Steel
5	Tip	Punta	Spitze	Pointe	Punta	Ponta	Punt
6	Back	Dorso	Rücken	Dos	Dorso	Dorso	Rug
7	Left hand profile	Profilo sinistro	Linkes Profil	Profil gauche	Perfil izquierdo	Perfil esquerdo	Links Profil
8	Right hand profile	Profilo destro	Rechtes Profil	Profil droit	Perfil derecho	Perfil direito	Rechts Profil
9	Silca item	Art. Silca	Silca-Artikel	Article Silca	Artículo Silca	Artigo Silca	Silca Artikel
10	Original profile	Profilo originale	Originalprofil	Profil original	Perfil original	Perfil original	Origineel profiel
11	Code	Serie	Serie	Code	Serie	Códigos	Code
12	Stem	Gambo	Halm	Canon	Pala	Haste	Kanon
13	Length	Lunghezza	Nötige Länge	Longueur	Longitud	Comprimento	Lengte

GLOSSARY - TERMINOLOGIA - TERMINOLOGIE - TERMINOLOGIE - TERMINOLOGIA - TERMINOLOGIA - TERMINOLOGIE

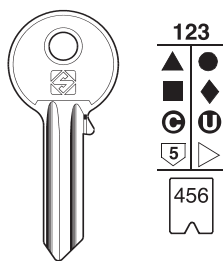

Information including material type is shown alongside each key.
 A fianco di ogni chiave sono specificate alcune caratteristiche tecniche e varianti disponibili.
 Neben jedem Schlüssel sind einige technische Daten und mögliche Varianten angegeben.
 A côté de chaque clé sont indiqués les caractéristiques techniques et matériaux disponibles.
 Al lado de cada llave se especifican datos técnicos y variantes disponibles.
 Ao lado de cada chave estão indicadas algumas características técnicas e as variantes disponíveis.
 Naast elke sleutel worden een aantal technische gegevens en mogelijke varianten weergegeven.

	Standard production material:	Materiale di normale produzione:	Material von normaler Produktion:	Matériel standard:	Material de producción corriente	Matéria-prima standard:	Standaard productiemateriaal:
	Steel	Acciaio	Stahl	Acier	Acero	Aço	Staal
	Brass	Ottone	Messing	Laiton	Latón	Latão	Messing
	Nickel silver	Alpacca	Neusilber	Maillechort	Alpaca	Alpaca	Nieuwzilver
	Iron	Ferro	Eisen	Fer	Hierro	Ferro	IJzer
123	Head-shape code adjacent to each key for easy identification of customized coining	Codice testa per facilitare la scelta di conii personalizzati	Kopf-Code, um die Auswahl der Prägungen zu erleichtern	Code de la tête pour faciliter le choix des frappes personnalisées	Código de la cabeza para facilitar la elección de acuñaciones personalizados	Código da cabeça para facilitar a escolha dos cunhos, no caso dos pedidos de chaves personalizadas	Code van de kop om de identificatie van de muntslag op maat te vergemakkelijken
	Available in SILCA COLOR/SLIM COLOR	Disponibile in SILCA COLOR/SLIM COLOR	Lieferbar in SILCA COLOR/SLIM COLOR	Disponibile en SILCA COLOR/SLIM COLOR	Disponibile en SILCA COLOR/SLIM COLOR	Disponível em SILCA COLOR/SLIM COLOR	Beschikbaar in SILCA COLOR/SLIM COLOR
	Available in ULTRALITE	Disponibile in ULTRALITE	Lieferbar in ULTRALITE	Disponibile en ULTRALITE	Disponibile en ULTRALITE	Disponível em ULTRALITE	Beschikbaar in ULTRALITE
	Available in SILKY	Disponibile in SILKY	Lieferbar in SILKY	Disponibile en SILKY	Disponibile en SILKY	Disponível em SILKY	Beschikbaar in SILKY
	No. of big pins	Nr. spine grandi	Nr. grosse Dornen	Nr. grands pistons	Nr. de agujas grandes	Nr. de pivos grandes	Aantal grote pinnen
	No. of small pins	Nr. spine piccole	Nr. kleinen Dornen	Nr. petits pistons	Nr. de agujas pequeñas	Nr. de pivos pequenos	Aantal kleine pinnen
	Back milled profile	Profilo dorsato	Rückengefrästes Profil	Profil à chiffrage dorsal	Perfil lomeado	Perfil boleado no dorso	Ruggefreed profiel
	Card Number for cutting by code on Silca electronic machines for flat keys.	Numero scheda per riproduzione a codice con macchine elettroniche Silca per chiavi piatte.	Kartenummer für die Kopierung nach Code auf Silca Elektronische Schlüsselkopiermaschine für Flachschlüssel.	Numéro de fiche pour la reproduction à code sur machines électroniques Silca pour clés plates.	Número de la ficha para la reproducción en base a código con duplicadoras electrónicas Silca para llaves planas.	Número de ficha técnica para a duplicação pelo código nas máquinas eletrônicas Silca (chaves planas).	Kaartnummer voor het frezen met code met de Silca elektronische machines voor cilindersleutels.
S56	Silca Serial Number for cutting by code on Silca electronic machines for dimple and laser keys.	Silca Serial Number per riproduzione a codice su duplicatrici elettroniche Silca per chiavi punzonate e laser.	Silca Serial Number für die Kopierung nach Code auf Silca Elektronische Schlüsselkopiermaschine für Bohrmulden Schlüssel und Bahnen-Schlüssel.	Silca Serial Number pour la reproduction à code sur machines électroniques Silca pour clés a points et clés avec taille de type laser.	Silca Serial Number para la reproducción en base a código con duplicadoras electrónicas Silca para llaves de seguridad y llaves de regatas.	Silca Serial Number para a duplicação pelo código nas máquinas eletrônicas Silca (chaves de pontos e tipo laser).	Silca serienummer voor het frezen met de Silca elektronische machines voor puntgeboorde en baangefreesde sleutels.

108 Catalogue Update

KEY IDENTIFICATION - IDENTIFICAZIONE CHIAVE - SCHLÜSSELIDENTIFIKATION - IDENTIFICATION CLÉ - IDENTIFICACIÓN DE LA LLAVE - IDENTIFICAÇÃO DE UMA CHAVE - SLEUTELIDENTIFICATIE

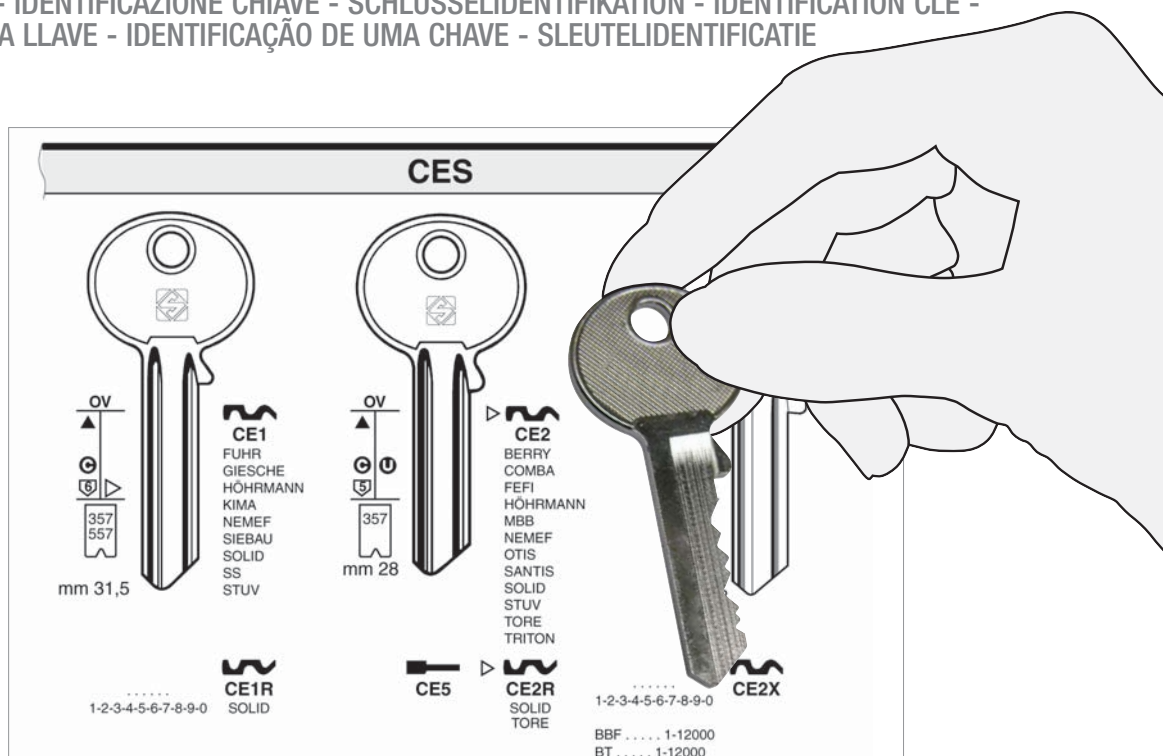

Keys are drawn to a 1:1 scale

Identification of a key may be made by laying the sample on the drawing, paying particular attention to the blade and to the profile. Alternative head shapes are indicated by images around the standard head.



I disegni delle chiavi sono in scala 1:1

I profili (sezione della canna) sono visti dalla testa. Per la ricerca basta sovrapporre la chiave campione al disegno esaminando particolarmente la canna (gambo) e la sezione (profilo).

Teste originali diverse sono rappresentate con linea tratteggiata.



Die Zeichnungen der Schlüssel sind in Skala 1:1

Die Profile (Schnitt der Stange) werden vom Kopf abgesehen. Für die Suche genügt es den Musterschlüssel mit der angegebenen Zeichnung zu vergleichen, aber wir empfehlen, besonders die Stange und das Profil zu überprüfen.

Verschiedene Originalköpfe sind durch gestrichelte Linien dargestellt.



Les dessins des clés sont à échelle 1:1

Les profils (section du canon) sont vus de la tête. Pour la recherche il suffira de superposer la clé échantillon au dessin en examinant tout particulièrement le canon (tige) et la section (profil).

Têtes originales différentes sont représentées par des lignes en tirets.



Los dibujos de las llaves son en escala 1:1

Los perfiles (sección de la caña) son vistos de la cabeza. Para la búsqueda basta sobreponer la llave de muestra al dibujo, examinando con particular atención la caña y la sección. Las cabezas originales diferentes están representadas con una línea punteada.



Os desenhos das chaves estão em escala 1:1

Os perfis (secção da cana) são vistos da cabeça. Para uma pesquisa eficiente, basta sobrepor a chave original por cima do desenho e examinar atentamente a cana da chave e o perfil. Cabeças originais diferentes estão representadas com uma linha tracejada.



Sleutels zijn getekend op schaal 1:1

De sleutel kan geïdentificeerd worden door deze op de tekening te leggen met bijzondere aandacht voor de steel en het profiel.

Alternatieve kopvormen worden aangegeven door de tekeningen rond de standaardkop.

USES - UTILIZZI - VERWENDUNGEN - UTILISATION - UTILIZACIONES - UTILIZAÇÕES - TOEPASSINGEN



	Security cylinders	Cilindri di sicurezza	Sicherheitszylinder	Cylindres de sécurité	Cilindros de seguridad	Cilindros de segurança	Veiligheidscilinders
	Electric board	Quadri elettrici	Schalttafel	Tableaux électriques	Cajas eléctricas	Quadros elétricos	Schakelpanelen
	Cash register locks	Registratori di cassa	Registriermaschine	Caisse enregistreuse	Registradoras de caja	Caixas registradoras	Kassasloten
	Furniture locks	Cilindri per mobili	Möbelzylinder	Cylindres pour meubles	Cilindros para muebles	Cilindros para mobiliário	Sloten van meubels
	Steering column locks	Bloccasterzo	Lenkschlösser	Blocage volant	Bloqueo para direcció	Bloqueios da direcção	Stuursloten
	Padlocks	Lucchetti	Vorhangschlösser	Cadenas	Candados	Cadeados	Hangsloten
	Shutter locks	Serrature per serranda	Falltürschlösser	Serrures pour stores métalliques	Cerraduras para cortinas metálicas	Fechaduras para grades de enrola	Sloten voor poorten
	Phone locks	Bloccatelefono	Telefonschlösser	Blocage du téléphone	Bloqueo para teléfonos	Bloqueios de telefone	Telefoonsleutels
	Glass door locks	Bloccacristalli	Glasschiebetürschlösser	Blocage porte en verre	Bloqueos para cristales	Trava dos vidros	Sloten voor glazen deuren
	Locomotives	Locomotive	Lokomotive	Locomotive	Locomotora	Locomotivas	Locomotieven
	Electric locks	Serrature elettriche	Elektrische Schlösser	Serrures électriques	Cerraduras eléctricas	Fechaduras elétricas	Elektrische sloten
	Briefcases	Valigette	Köfferchen	Mallettes	Maletines	Maletas	Aktetassen
	Safes	Cassette di sicurezza	Sicherheitsfach	Coffres-forts	Caja de seguridad	Cofres	Brandkasten
	Lifts	Ascensori	Aufzüge	Ascenseurs	Ascensores	Elevadores	Liften
	Juke box / Flipper	Juke box / Flipper	Juke box / Spielautomaten	Juke box / Flipper	Juke box / Flipper	Juke box / Flipper	Jukeboxen / Flipperkasten
	Reinstated key	Chiave ripristinata	Wiedereingeführter Schlüssel	Clé restaurée	Llave restablecida	Chave restabelecida	Terug ingevoerde sleutel
	Mail boxes	Casellari postali / Cassette per lettere	Fachkasten	Boîtes postales / Boîtes aux lettres	Casillas postales / Buzones	Caixas de correio	Brievbusen
	Antitheft devices for motor-cycles	Antifurto per ciclomotori / motociclette	Diebstahlschutz für Motorfahrrad und Motorräder	Antivolts pour cyclomoteurs / motocyclettes	Antihurto para ciclomotores y motocicletas	Anti-roubo para scooters e motocicletas	Anti-diefstal apparatuur voor motorfietsen
	Bicycle	Bicicletta	Fahrrad	Vélo	Bicicleta	Bicicleta	Fietsen

108 Catalogue Update

TECHNICAL INFORMATION - INFORMAZIONI TECNICHE - TECHNISCHE AUSKÜNFTEN - INFORMATIONS TECHNIQUES - INFORMACIONES TÉCNICAS - INFORMAÇÕES TÉCNICAS - TECHNISCHE INFORMATIE



2

PER / FOR

ABLOY (S)

ABT (I)

VIRO (135)

ABUS (D)

BRICARD
CISA
GEGE
JPM
OTHMER
TOP

+ CISA (31-32-33)

+ GUERVILLE
RIQUIER (63)

PER:
FOR:

ABLOY

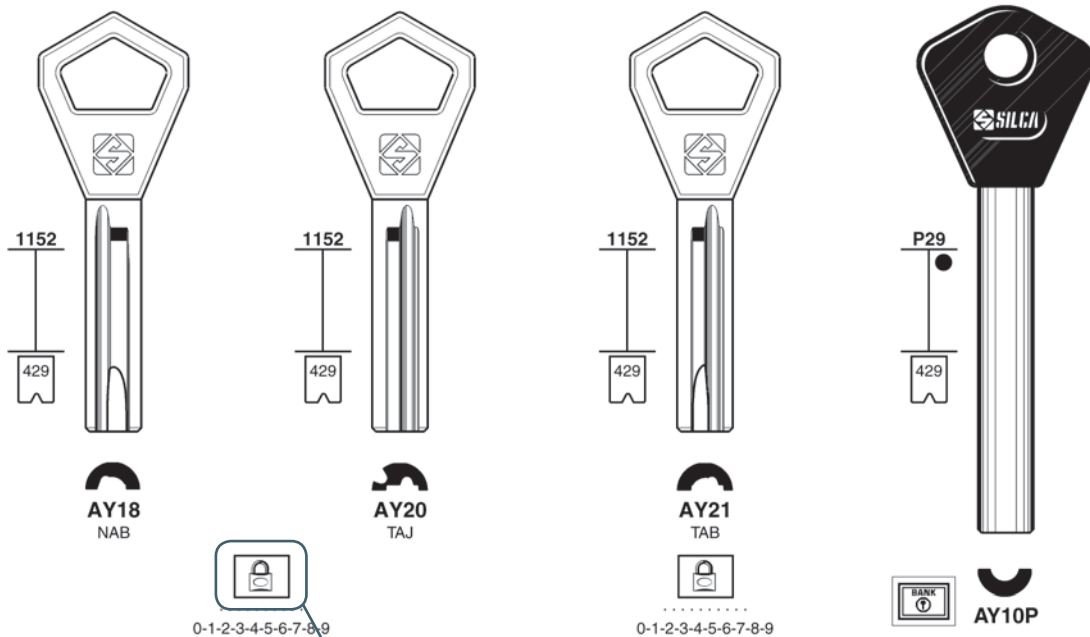

PER:
FOR:

ABUS



Use (page IX)

Utilizzo (pag. IX)

Verwendung (Seite IX)

Utilisation (page IX)

Uso (pág. IX)

Utilização (pág. IX)

Toepassing (pagina IX)

TECHNICAL INFORMATION - INFORMAZIONI TECNICHE - TECHNISCHE AUSKÜNFTEN - INFORMATIONS TECHNIQUES - INFORMACIONES TÉCNICAS - INFORMAÇÕES TÉCNICAS - INFORMAZIONI TECNICHE

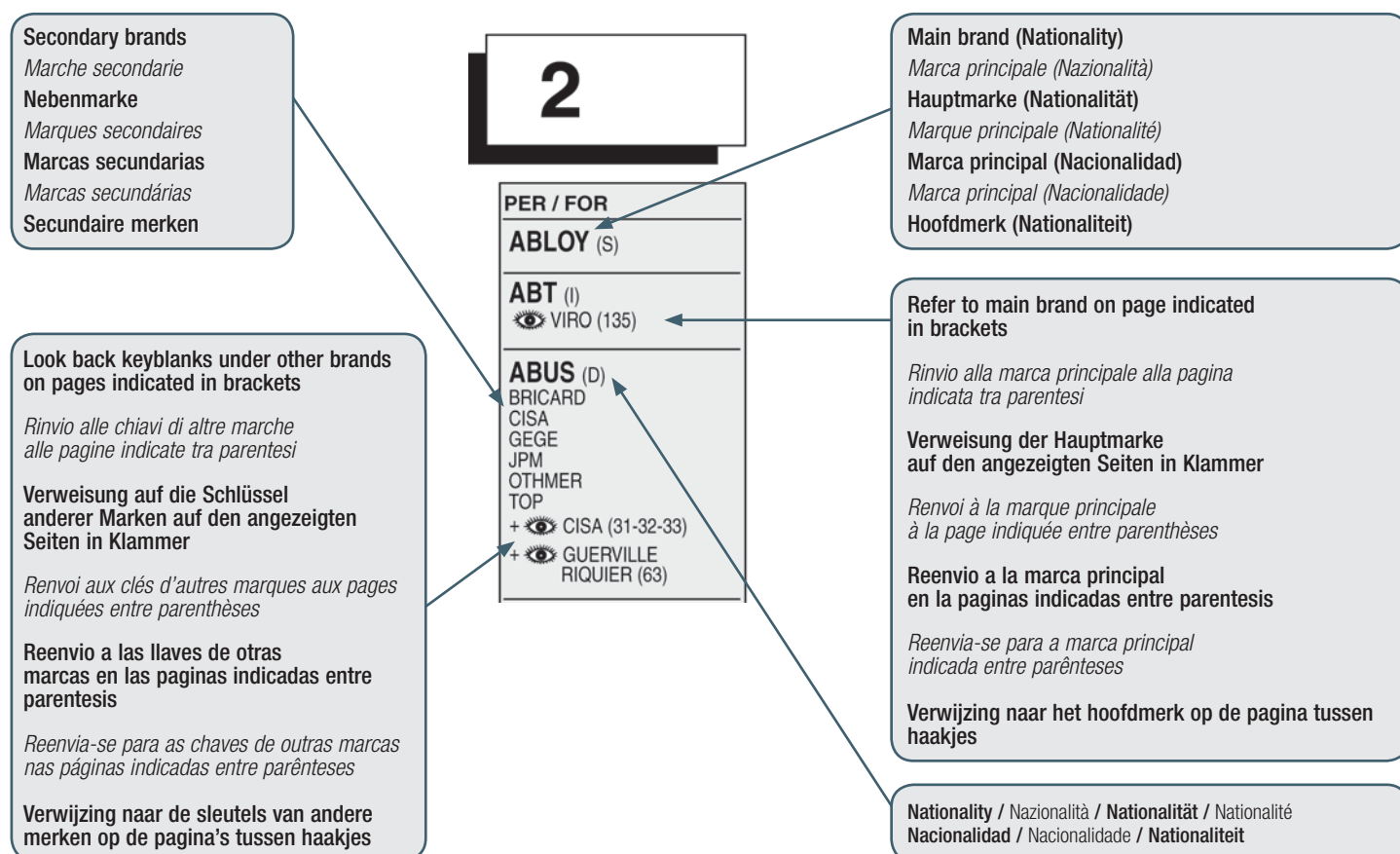

NATIONALITY / NAZIONALITÀ / NATIONALITÄT / NATIONALITÉ / NACIONALIDAD / NACIONALIDADE / NATIONALITEIT

AT	Austria	DE	Germany	IL	Israel	RS	Serbia
AU	Australia	DK	Denmark	IN	India	RU	Russia
AZ	Azerbaijan	DZ	Algeria	IT	Italy	SA	Saudi Arabia
BE	Belgium	EE	Estonia	JP	Japan	SE	Sweden
BG	Bulgaria	EG	Egypt	LT	Lithuania	SI	Slovenia
BR	Brazil	ES	Spain	LV	Latvia	TN	Tunisia
BY	Belarus	FI	Finland	ZM	Zambia	TR	Turchia
CA	Canada	FR	France	MD	Republic of Moldova	TW	Taiwan
CH	Switzerland	GB	Great Britain	NG	Federal Rep. of Nigeria	UA	Ukraine
CL	Chile	GR	Greece	NL	The Netherlands	US	United States of America
CN	China	HK	Hong-Kong	NO	Norway	VE	Venezuela
CO	Colombia	HR	Croatia	PL	Poland	ZA	Republic of South Africa
CZ	Czech Republic	HU	Hungary	PT	Portugal		
DZ	Algeria	IE	Ireland	RO	Romania		

108 Catalogue Update



SLIM COLOR

22 SM1	29 OC074	31 PF092 PF092S PF2	33 PF1	54 CA2 R041 R08	60 VAC2	168 UNI3	182 YA1	369 TE2
423 MER8	599 AGB1R	745 RU14	1182 BD9R	1219 CS115	1557 MER1	1604 KE1	1605 KE3	1606 KE9
A CB6 CS204 CS206 FM090 FM1 IE6 JM2R MTA1R UL050 UL051 VI080 VI082 WA1R WA2R	L UL050SL UL051SL UL052SL UL053SL UL054SL UL055SL UL058SL YT15 YT16	N CB85 CC1 CS7 IE3 UL058 VI084 VI086	OV RU1 VAC151	Y YA226 YA31 YA6				

SLIM COLOR DIMPLE KEYS - SLIM COLOR CHIAVI PUNZONATE - SLIM COLOR BOHRMULDENSCHLÜSSEL - SLIM COLOR CLÉS À POINTS - SLIM COLOR LLAVES DE SEGURIDAD - SLIM COLOR CHAVES DE PONTOS - SLIM COLOR PUNTGEBOORDE SLEUTELS

1130 IE15	1219 CS62	1275 AGB5 AGB8	1434 CB97	1456 CS146
------------------	------------------	--------------------------	------------------	-------------------

108 Catalogue Update



COLOR

1	16	54	60	168	182	301	305	438
BE200	DX1	CA2	VAC3	UNI3	CEN1R	SH3	KA1	LW4
		EV10X1			YA1E			
		EV3R						
		EV69X						
		GE1X						
		GE7RX						
		GE8R						
717	745	A	FA	L	N	Y	OV	OV
BD6	RU14	AG2R	BAI1	UL050L	CC1	YA226	AB1X	DM3X
BD6R		AG3		UL050XL	UL058	YA31	BK1X	KF1
		UL050		UL051L			BK3-12	RU1
		UL051		UL052L			BK3-3	T01X
		UL054					BK3-4	T029X
		VAC29					BK3-7	UL050X
		VI080					BK3-8	WK1X
							CE1	ZE1
							CE2	ZE1RX
							CE2X	ZE1X
							DM3	ZE2

108 Catalogue Update



SERIE DISTINZIONE HEADS

For the most common keys Silca has created a series of 18 different exclusive heads called the "Serie Distinzione" to offer a wide range of possibilities to customize your keys. Choose your favourite heads: on the following pages you can find all available items with 18 types of heads from the "Serie Distinzione".



TESTE SERIE DISTINZIONE

Per le chiavi più comuni Silca ha creato una serie di 18 esclusive teste diverse chiamate "Serie Distinzione" per offrire una notevole possibilità di scelta per personalizzare le vostre chiavi. Scegliete le teste che vi piacciono: nelle pagine seguenti troverete tutti gli articoli disponibili con i 18 tipi di teste della "Serie Distinzione".



SCHLÜSSELKÖPFE DER SERIE "DISTINZIONE"

Für die gängigsten Schlüssel hat Silca eine Serie mit 18 verschiedenen Köpfen mit dem Namen "Distinzione" geschaffen, um Ihnen eine beachtliche Auswahl zur Personalisierung Ihrer Schlüssel zur Verfügung zu stellen. Wählen Sie die Köpfe, die Ihnen am besten gefallen. Auf den folgenden Seiten finden Sie alle Artikel, die über die 18 Kopfarten der "Serie Distinzione" verfügen.



TÊTES SÉRIE DISTINCTION

Pour les clés les plus communes, Silca a créé une série de 18 têtes exclusives sous la dénomination «Série Distinction» afin de fournir un vaste choix permettant de personnaliser vos clés. Sélectionnez les têtes qui vous plaisent: les pages suivantes proposent tous les éléments disponibles avec les 18 types de têtes de la «Série Distinction».



CABEZAS SERIE DISTINZIONE

Para las llaves más comunes, Silca ha creado una serie de 18 cabezas diferentes y exclusivas, llamada "Serie Distinzione", que ofrece una amplia variedad de opciones para personalizar las llaves. Elija las cabezas que más le gusten: en las páginas siguientes encontrará todos los artículos disponibles con los 18 tipos de cabeza de la "Serie Distinzione".



CABEÇAS SERIE DISTINZIONE

Para as chaves mais comuns, a Silca criou uma série de 18 cabeças exclusivas diferentes denominadas "Serie Distinzione", oferecendo assim uma maior possibilidade de escolha para personalizar as suas chaves. Escolha o tipo de cabeça preferido: nas páginas seguintes você vai encontrar todos os artigos disponíveis com os 18 tipos de cabeças da "Serie Distinzione".



KOPPEN SERIE DISTINZIONE

Voor de meest voorkomende sleutels heeft Silca een reeks van 18 verschillende en exclusieve koppen ontwikkeld, genaamd "Serie Distinzione" om zo een brede waaier aan mogelijkheden te bieden die bij uw sleutels passen. Kies uw favoriete kop: op de volgende pagina's vindt u de beschikbare items met 18 soorten koppen van de "Serie Distinzione".



SERIE DISTINZIONE HEADS - TESTE SERIE DISTINZIONE - SCHLÜSSELKÖPFE DER SERIE "DISTINZIONE" - TÊTES SÉRIE DISTINCTION - CABEZAS SERIE DISTINZIONE - CABEÇAS SERIE DISTINZIONE - KOPPEN SERIE DISTINZIONE

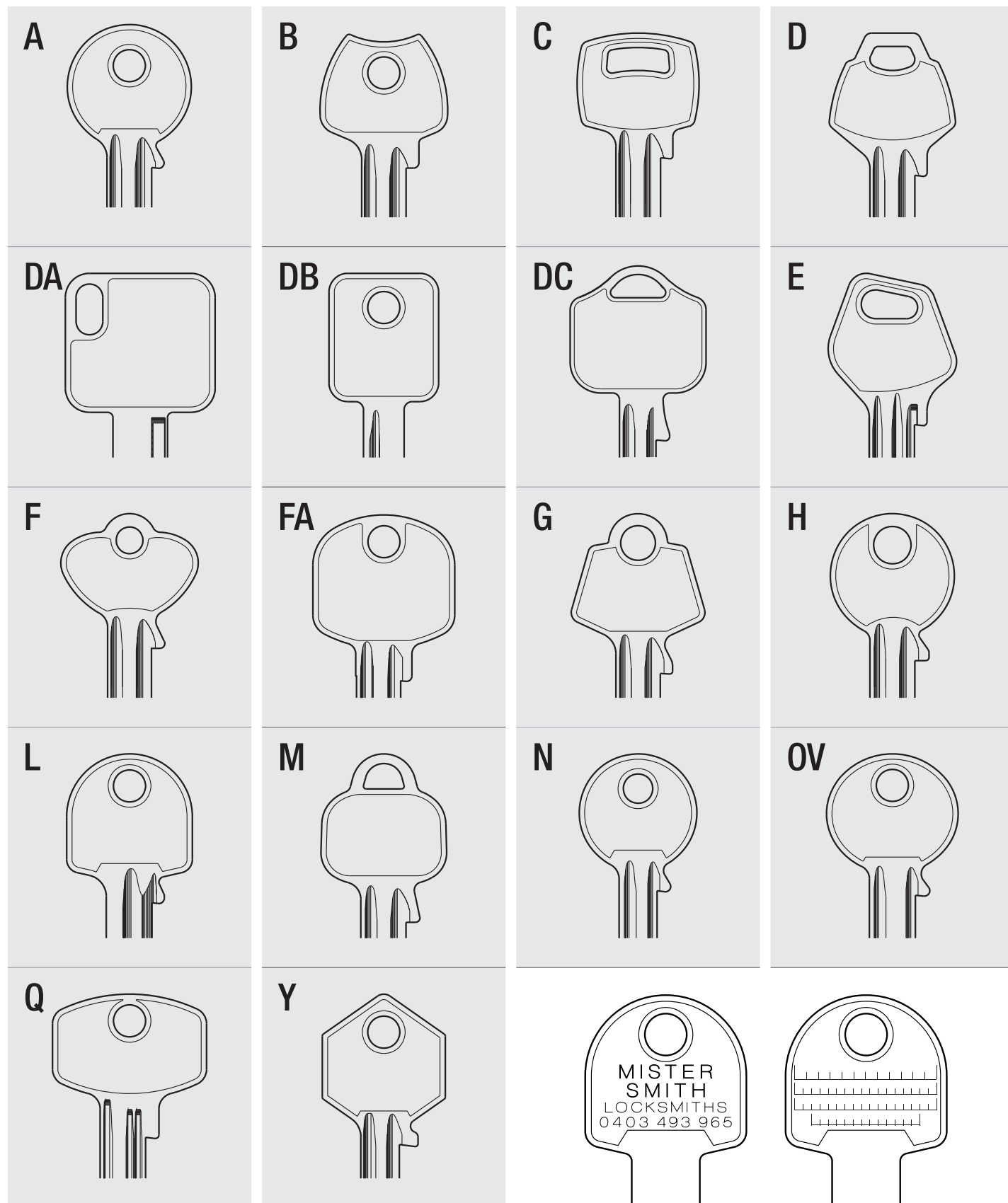

108 Catalogue Update

A

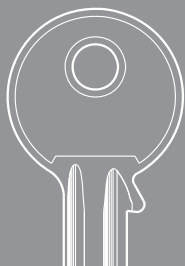

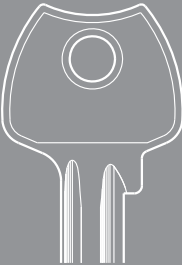
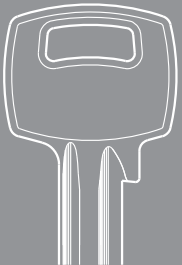

AA1	CB20	FAM1	IE8	LP20R	OA2R	SE7R	UL048	WA6R
AA1R	CB5	FAM1R	IE8R	LP5	OA3R	SI1R	UL049	WE1
AA5	CB6	FAM2R	IL1	LP5R	OL4	SIL1R	UL050	WE14
AA5R	CB78R	FB26	IL1R	LP7	OL5	SN3R	UL051	WE15
AA6	CB83	FB26R	ILS1	LP7R	OL5R	SN4R	UL052	WE16
AA6R	CC1	FEB1	JOW8	LT2	OL6	SO4	UL053	WE16R
AAA1	CEE1	FEB1R	JS1	MG1	OV1	SO7	UL054	WE1R
AB14	CLS242	FEB2	JS1R	MG1R	OV1R	SO8R	UL055	WE2
AB14R	CLS3	FEB2R	JW1	MG2	OV2	SQ4R	UL058	WE2R
AB54	COR1	FF1	JW11	MG2R	OV2R	SS12	UL059	WE5
AG2	CS121	FF1R	JW12	MG3	PC1	STA1	UL062	WE5R
AG2R	CS15R	FF2	JW13	MI1	PC10	STA1R	UL063	WE7
AG3	CS204	FF7	JW1R	MI1R	PC10R	STA2	UM2	WE7R
AG3R	CS205	FF7R	JW2	MI2	PC14	STA2R	UNI3	WMS1
AG4	CS206	FF8	JW2R	MI2R	PC18R	STA3	VAC29	WMS2
AG4R	CS207	FF8R	JW3	MI5	PC19R	STA3R	VI080	WR1
AG7	CS33	FF9	JW4R	MI5R	PC1R	SVN2	VI081	WR2
AG7R	CS33R	FF9R	JW5	MIG1	PC20	TAR4	VI082	YA1
AGB1R	CS38A	FH10R	JW6	MIG2	PC4	TAR4R	VI083	YA226
AKR9R	CS4R	FH13	JW7R	MN1	PC4R	TAR5	VI086	YA31
ALM1	CS68	FH15	JW8	MN2	PF092	TAR5R	VI1	YA31R
ALM1R	CS7	FH18	JW9	MN2R	PF092S	TG1	VI10	YA6
AMC1R	CS70	FH8R	KAK1	MN3	PF18	TL11	VI10R	YAR1
AMC2R	CT1	FM090	KEI1R	MN3R	PF2	TL11R	VI11	YT15
AMC3	CT1R	FM2	KK1	MN4R	PF210	TL13	VI12	ZA2R
AZ2	CT2	GD2	KLE3R	MN7	PF211	TN16	VI13	ZI1
AZ2R	CT2R	G01R	KLE3RX	MN7R	PF2S	TN16X	VI1R	ZI1R
AZ4	CVL1	G02R	KLE3X	MON1	PF7	TN2	VI2	ZI2R
BAI5R	CVL1R	GS7	KLE5RX	MON1R	PF7S	TN39	VI23	ZI4
BAL7	CVL3	GSS1	KLE5X	MP228	PF8	TO26	VI2R	ZI4R
BD2	CVL3R	HDL3	KLE6RX	MP229	PF8R	TP1	VI6	ZI5
BD2R	CVL4	HDL3R	KLE6X	MP230	PG1	TP1R	VI9	ZI5R
BE200	DEA2	HE1	KLE7RX	MP231	PG1R	TP2	VI9R	
BE201	DM32	HE1R	KLE7X	MSF1	PT2	TP2R	VL2	
BE202	DO1R	HE3R	KM1	MTA1R	RIQ9	TR2	VL2R	
BI110	EA1	IB1	KM1R	MTA3R	RIQ9R	TRM2	VL3	
BM1	ECM1	ICS1	LD4	MTA4	RM1A	TS1	VL3R	
BM2	ECM1R	ICS1R	LD4R	MTK5	RM1RA	TS2	WA1	
BR1	EL1	ICS2	LD5R	MTK5R	RM2A	TU1	WA1R	
BS1	ER2	ICS2R	LN1	NF1	RM2RA	UAP2	WA2	
CA10	ER3R	ICS3	LP13	NF1R	RZA3	UL046	WA2R	
CA10R	EVO1	IE6	LP13R	OA2	SE7	UL047	WA6	

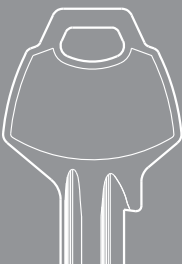
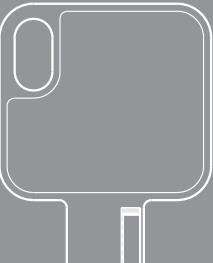
B 	CS204	IE2R	UL053	C 	ADT1	EL1	UL053
	CS205	MG1R	WA1		CS204	IB1	VI080
	CS206	UL050	WA1R		CS205	UL050	VI082
	CS207	UL051			CS206	UL051	WA1R
	EL1	UL052			CS207	UL052	WA2R

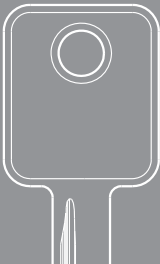
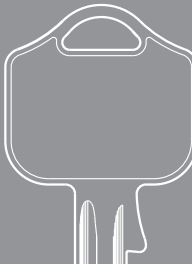

D 	CS204	EL1	UL051	DA 	AB1	CS206	T030R
	CS205	JL2	UL052		BK1	CS207	UL050
	CS206	JL2R	UL053		BK1R	MTA3R	
	CS207	UL050					

DB 	AB3	BUR2R	HW1	DC 	LW4	UL050	UL054
	AB3R	CE4	JU1		MIW14	UL051	
	BA2	CE7	RB2				
	BA2R	CS7	YA8				
	BUR1	DM10	YA8R				
	BUR1R	DM8					
	BUR2	HN1					

E 	AB91	FM1	JL5	VL5	F 	CS204	UL050
	BK26	FM6	PC13	VL5R		CS205	UL051
	CB6	FM7	UL050	WA1		CS206	UL052
	CS204	IB1	UL051	WA1R		EL1	
	CS205	JL3	UL052	WST1			
	CS206	JL3R	UL053	WTR1R			
	CS207	JL4	VI080				
	EL1	JL4R	VL2R				

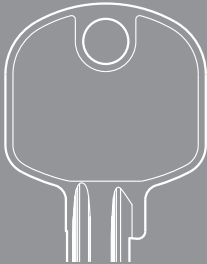
108 Catalogue Update

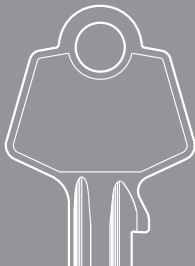
FA 	AB1	AB47R	BK1X	CS24	GR3	LT2	TN19R	UL050X	YA1
	AB10	BAI1	CA2	DM119	IB1	R024	TN23	UL051	YT15
	AB10R	BD3	CE2	DM14	IB1R	R08	TO1	VAC151X	ZE1
	AB1R	BD3R	CE2X	DM3	IE6	SI1R	TO1X	VAC2X	ZE1R
	AB1RX	BD4R	CS13	DM3X	JM1	STL1R	TOP1R	VAC48X	ZE1X
	AB1X	BD9R	CS206	EV10	JM2R	TE2	TOP1RX	WK1	
	AB22	BK1	CS207	EV10X	LH42X	TE8X	UL050	WK1X	

G 	CB6	PF2	H 	CS206	FF3	MN9R	WA7
	CS204	UL050		CS207	FF3R	UL050	WA7R
	CS205	UL051		DS5R	MN8	UL051	
	CS206	UL052		FF10	MN8R	UL052	
	CS207	UL053		FF10R	MN9	UL053	
	EL1						

L 	AB1	BAB14	CS205	EL1	FF2	LC2R	PF2	TN16X	UL052X
	AB1R	BES1	CS205X	EV10	FH31	LP21	PF212	TN2	UL053
	AB1X	BK1	CS206	EV10X	GE1	LP5	PF2S	TO1	UL053SL
	AB36	BK1X	CS206X	EV3	GE106	LP5X	RW8R	TO1X	UL053X
	AB36R	BK5-16	CS207	EV4	GE106X	LT2	SAR17	TO30RX	UL054
	AB54	BK5-6	CS207X	EV69X	HUT1	LT2X	SAR17R	TOP1R	UL054SL
	AB63	CB25R	CVL1	EZ2R	IB1	LT4	SAR3	TOP1RX	UL054X
	AE2R	CB6	CVL1R	FAC7	IE12	LT4X	SAR3R	TY1	UL055
	AG3	CB6X	CVL3	FB13R	IE2	LW4	SH10	UC1	UL055X
	AG3R	CE2	CVL3R	FB13RX	IE6	LW4R	SH11	UC1R	UL058SL
	AGB1R	CE20	CYS1	FB15RX	ILC2	LW5	SH3	UL050	UL062
	AGB2R	CE20X	DM119	FB19R	JOW10	MC12	SH5	UL050SL	UL063
	ASEC2	CE2X	DM119X	FB20RX	JS2	MC2	SH7	UL050X	UNI3
	AW5	CE41X	DM14	FB21R	KF1	MC2R	SH9	UL051	VAC2
	AW7	CS13X	DM3	FB22R	KS1	MER8	SL1	UL051SL	VAR3
	AZ2	CS143X	DM3X	FB25R	LC11	MS2	TE2	UL051X	VI080
	AZ2R	CS204	DX1	FB28R	LC11R	PF092	TE2X	UL052	VI081
	BAB13X	CS204X	EG1	FDR2	LC2	PF092S	TE6	UL052SL	VI082

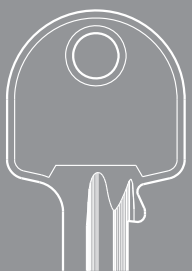
L 	VL2R	WE1	WK1	YA1	YA226X	YA6	ZE1	ZE1X	
	WA1	WE2R	WK1X	YA1E	YA31	YA6X	ZE12X	ZE39RX	
	WA1R	WE1	WMS1	YA1X	YA31X	YT15	ZE1R		
	WA2R	WEI2	WS3	YA226	YA5	YT16	ZE1RX		

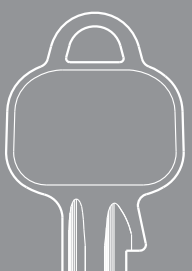
M 	AE1R	CS206	IB1	MIL2	UL051	UL053	VI082	YA226	
	CS204	CS207	KS1	UL050	UL052	VI080	YA1E		

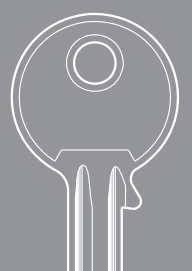
N 	BD17	CB3	FF18	IE3R	MTY2	RGM1R	UL057	WE3	ZI3R
	BSI1	CB85	GL3	JB1	NE34	RX1	UL058	WE3R	
	BSI1R	CC1	GL3R	JL1	OB1	STA8	UL059	WK3	
	BSI2R	CC1R	GL4	JOW4R	OC074	STA8R	UL060	YD4	
	BSI4	CEN2	GL4R	JU1	PA2	TAR3	UL061	YD4R	
	BSI4R	CEN2R	IE1	JU1R	PA2R	TAR3R	VI084	YT13	
	CA1	CS7	IE1R	MN5	PF070	TAR8	VI085	YT13R	
	CA9	FF14	IE28R	MN5R	PF9	TRE2	VI086	YT7	
	CB15	FF17	IE3	MTY1	RGM1	UL056	VI087	YT7R	

OV 	AB1	AB33	AB70X	ASS186	BK1	BK27	BK3-3	BK5-1	BK5-16
	AB10	AB4	AB79RX	AZ5	BK13	BK2R	BK3-4	BK5-10	BK5-17
	AB10R	AB5	AB8	BAB31	BK1R	BK3-1	BK3-5	BK5-11	BK5-18
	AB1R	AB55X	AB8R	BAI23	BK1X	BK3-10	BK3-6	BK5-12	BK5-19
	AB1RX	AB6	AL1	BAL1	BK21R	BK3-11	BK3-7	BK5-13	BK5-2
	AB1X	AB68X	AL1R	BAL1R	BK22R	BK3-12	BK3-8	BK5-14	BK5-20
	AB21R	AB69X	ARE1	BG1	BK23R	BK3-2	BK3-9	BK5-15	BK5-21

108 Catalogue Update

OV



BK5-22	BK6-3	CO1	EV69X	JOW12RX	LYG6	STU1	T054-7	T09RY1
BK5-23	BK6-30	CO1R	FAM6	JOW12X	LYH	SV3	T054-8	T09RY10
BK5-24	BK6-31	COR1	FB35R	JOW1R	LYH6	SV3R	T06	T09RY11
BK5-25	BK6-32	CS13X	FH16R	KF1	LYK	SV7	T07	T09RY12
BK5-26	BK6-33	CS206	FH30	KFA	LYK6	TN16X	T075R	T09RY13
BK5-27	BK6-34	CS206X	FS1	KFB	LYP5B	TN42	T081R	T09RY14
BK5-28	BK6-35	CS207	FS1R	KFC	LYP6A	TN42R	T082R	T09RY15
BK5-29	BK6-4	CS31R	FV1	KFD	LYP6D	T01	T08RX1	T09RY16
BK5-3	BK6-5	CS52X	GD8	KFE	MEG2	T0108X	T08RX10	T09RY17
BK5-30	BK6-6	DF3	GD8R	KFF	MIL1	T015	T08RX11	T09RY18
BK5-31	BK6-7	DF3R	GE1	KFG	ORA2	T016	T08RX12	T09RY2
BK5-32	BK6-8	DM105R	GOD4R	KFH	RG1	T017	T08RX13	T09RY3
BK5-33	BK6-9	DM11	GR1R	KFI	RO8	T01X	T08RX14	T09RY4
BK5-34	BK7R-1	DM119	GR9-5	KFJ	RU1	T02	T08RX15	T09RY5
BK5-35	BK7R-10	DM119X	GR9-7	KFK	RU10R	T025R	T08RX16	T09RY6
BK5-4	BK7R-2	DM123-1	GR9-8	KFL	RU11R	T028R	T08RX17	T09RY7
BK5-5	BK7R-3	DM123-	GR9-9	KFM	RU12	T029X	T08RX18	T09RY8
BK5-6	BK7R-4	10	GR9R-1	KFN	RU13	T03	T08RX2	T09RY9
BK5-7	BK7R-5	DM123-2	GR9R-3	KFO	RU16	T030	T08RX3	T09Y1
BK5-8	BK7R-6	DM123-3	GV7	KFR	RU19	T030R	T08RX4	T09Y10
BK5-9	BK7R-7	DM123-4	GVA	KFS	RU1R	T030RX	T08RX5	T09Y11
BK6-1	BK7R-8	DM123-6	GVA6	KFU	RU2	T030X	T08RX6	T09Y12
BK6-10	BK7R-9	DM123-7	GYB	KFW	RU20	T031R	T08RX7	T09Y13
BK6-11	BLA1	DM123-8	GYB6	KFX	RU21	T034	T08RX8	T09Y14
BK6-12	BLA2	DM123-9	GYC	LC11R	RU22R	T039R	T08RX9	T09Y15
BK6-13	BLA3	DM25	GYC6	LH4	RU23R	T04	T08X1	T09Y16
BK6-14	BRT1	DM28	GVD	LH42	RU28	T05	T08X10	T09Y17
BK6-15	BVA1	DM3	GVD6	LP21	RU2R	T054-1	T08X11	T09Y18
BK6-16	BVA1R	DM35R	GVE6	LP5	RU3	T054-13	T08X12	T09Y2
BK6-17	BY1	DM3X	GYF	LW24	RU3R	T054-14	T08X13	T09Y3
BK6-18	C1	DM48	GYF6	LYA	RU4R	T054-16	T08X14	T09Y4
BK6-19	C1R	DM7	GYG	LYA6	RU5	T054-17	T08X15	T09Y5
BK6-2	CB6	DO6	GYG6	LYB	RU5R	T054-18	T08X16	T09Y6
BK6-20	CB6X	EM11	GYH	LYB6	RU6	T054-19	T08X17	T09Y7
BK6-21	CE1	ER1	GYH6	LYC	RU7	T054-2	T08X18	T09Y8
BK6-22	CE17WPS	ERT1	GYK	LYC6	RU8R	T054-20	T08X2	T09Y9
BK6-23	CE1R	ET1	GYK6	LYD	RU9R	T054-21	T08X3	TOP1RX
BK6-24	CE2	ET1R	GYP5A	LYD6	SAN1	T054-23	T08X4	TR15
BK6-25	CE20	ET2R	GYP5B	LYE	SAN1R	T054-24	T08X5	TU2
BK6-26	CE2R	EV10	GYP5D	LYE6	SEI10	T054-3	T08X6	UL050
BK6-27	CE2X	EV10X	GYP6B	LYF	SHW1	T054-4	T08X7	UL050X
BK6-28	CE41X	EV2	HT2	LYF6	ST1	T054-5	T08X8	UL051
BK6-29	CE5	EV3	JOW1	LYG	STL1RX	T054-6	T08X9	UL051X

OV



UNI28	VYF	WK15	WK2R	WK44R	WSD1	YYA	YYK	ZE1X
UP1	VYF6	WK16	WK30	WK45R	WSD1R	YYA6	YYK6	ZE2
VAC151	VYG	WK17R	WK31	WK45X	YA1	YYB	YYP6A	ZE34
VAC30	VYG6	WK18	WK32	WK46	YA27R	YYB6	YYP6B	ZE34R
VAC30R	VYH	WK19	WK33	WK47R	YA31	YYC	YYP6D	ZE34RX
VG1	VYH6	WK1X	WK34	WK48	YA5	YYC6	ZE1	ZE34X
VYA	VYK	WK2	WK35	WK5	YA67	YYD	ZE10	ZE39
VYA6	VYK6	WK20	WK36	WK52R	YA70	YYD6	ZE10R	ZE39RX
VYB	VYP6B	WK21	WK37	WK53R	YA70R	YYE	ZE12	ZE39X
VYB6	VYP6D	WK22	WK38	WK54R	YA71	YYE6	ZE12X	ZE40X
VYC	WK1	WK25	WK39	WK56R	YA71R	YYF	ZE13	
VYC6	WK10	WK25R	WK4	WK6	YA72	YYF6	ZE13R	
VYD	WK11	WK26	WK40	WK6R	YA72R	YYG	ZE15	
VYD6	WK12	WK27	WK41R	WK7	YA84	YYG6	ZE16	
VYE	WK13	WK28	WK42R	WK71X	YA84R	YYH	ZE1R	
VYE6	WK14	WK29	WK43R	WK9	YA9	YYH6	ZE1RX	

Q

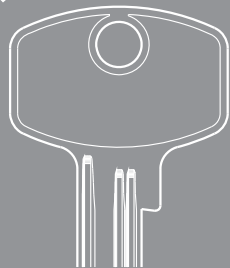

AB1	DM12-13	DM12-00	DM12-29	DM12-6	DM29	DM65-12	DM65-32	DM65R-19
AB1R	DM12-14	DM12-1	DM12-3	DM12-7	DM29R	DM65-13	DM65-33	DM65R-31
BK1	DM12-15	DM12-10	DM12-30	DM12-8	DM3	DM65-14	DM65-34	DM65R-32
CA11	DM12-16	DM12-11	DM12-31	DM12-9	DM33R	DM65-15	DM65-35	DM65R-34
CA2	DM12-17	DM12-12	DM12-32	DM12R-00	DM40	DM65-16	DM65-36	DM65R-35
CA8	AB1	DM12-13	DM12-33	DM12R-12	DM40R	DM65-17	DM65-4	DM65R-36
CB6	AB1R	DM12-14	DM12-34	DM12R-13	DM42	DM65-18	DM65-40	DM66
CE2	BK1	DM12-15	DM12-35	DM12R-16	DM42R	DM65-19	DM65-41	DM66R
CS206	CA11	DM12-16	DM12-36	DM12R-19	DM43	DM65-2	DM65-42	DM67
DM103	CA2	DM12-17	DM12-37	DM12R-31	DM43R	DM65-20	DM65-43	DM67R
DM108	CA8	DM12-18	DM12-38	DM12R-32	DM44	DM65-21	DM65-44	DM68
DM108R	CB6	DM12-19	DM12-39	DM12R-34	DM44R	DM65-22	DM65-45	DM68R
DM109	CE2	DM12-2	DM12-4	DM12R-35	DM45	DM65-23	DM65-46	DM69
DM109R	CS206	DM12-20	DM12-40	DM12R-36	DM46R	DM65-24	DM65-5	DM69R
DM115	DM103	DM12-21	DM12-41	DM14	DM47	DM65-25	DM65-6	DM70
DM115R	DM108	DM12-22	DM12-42	DM141R	DM47R	DM65-26	DM65-7	DM70R
DM119	DM108R	DM12-23	DM12-43	DM150	DM50	DM65-27	DM65-8	DM71
DM12-00	DM109	DM12-24	DM12-44	DM18	DM60	DM65-28	DM65-9	DM71R
DM12-1	DM109R	DM12-25	DM12-45	DM18R	DM65-00	DM65-29	DM65R-00	DM72
DM12-10	DM115	DM12-26	DM12-46	DM20	DM65-1	DM65-3	DM65R-12	DM72R
DM12-11	DM115R	DM12-27	DM12-47	DM26	DM65-10	DM65-30	DM65R-13	DM73
DM12-12	DM119	DM12-28	DM12-5	DM26R	DM65-11	DM65-31	DM65R-16	DM73R

108 Catalogue Update

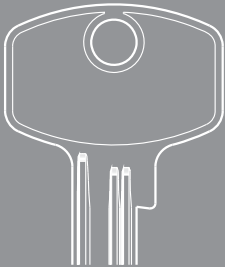
Q 	DM74	DM78	DM82	DM85R	DM89	DM93R	LT2	UL051	ZE1R
	DM74R	DM78R	DM82R	DM86	DM90	DM94R	RIQ1R	VAC2	
	DM75	DM79	DM83	DM86R	DM91	DM95	R08	VI080	
	DM75R	DM79R	DM83R	DM87	DM91R	DM95R	TE2	VI15R	
	DM76	DM80	DM84	DM87R	DM92	DM97R	TO1	VI16R	
	DM77	DM81	DM84R	DM88	DM92R	IB1	TOP1R	WK1	
	DM77R	DM81R	DM85	DM88R	DM93	LEA1	UL050	YA1	

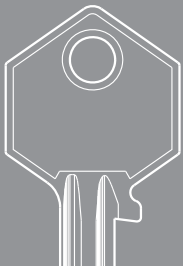
Y 	EL1	UL051	YA227	YA42	YA46	YA50	YA54	YA58	YA61
	JH1	UL054	YA31	YA43	YA47	YA51	YA55	YA59	YA62
	PC11	VAL1	YA31R	YA44	YA48	YA52	YA56	YA6	YA63
	UL050	YA226	YA41	YA45	YA49	YA53	YA57	YA60	YA6R



Keys
Chiavi
Schlüssel
Clés
Llaves
Chaves
Sleutels

PER:
FOR: **3M**

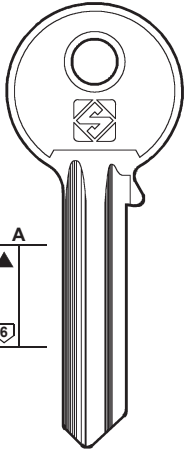

TRM3

ABUS

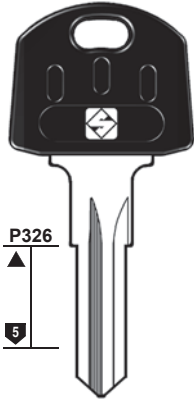

AB58AP

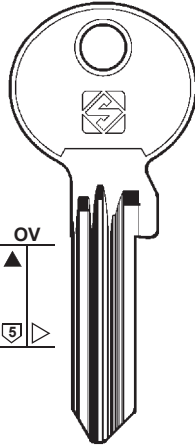

AB88X

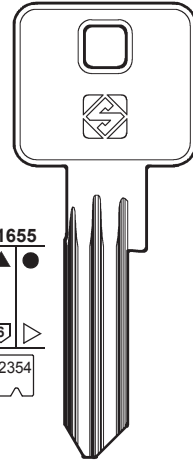

AB89
E60
..... 00001-30000

AB95
E60
..... 1234567
E20/E30
..... 00001-30000



BUFFO



3

PER / FOR

3M (CN)

ABUS (DE)
BUFFO
+ CISA (7)

AGB (IT)

AGE (JP)

ALA (IT)

ALPHA (IT)

ANCHOR (SE)
ANKERSLOT

ANKERSLOT (NL)
+ ANCHOR (3)

PER:
FOR: **ABUS**

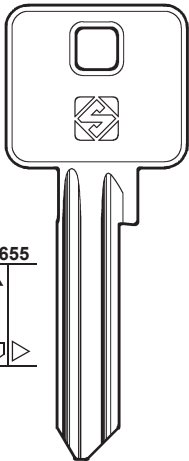

AB98

AGB

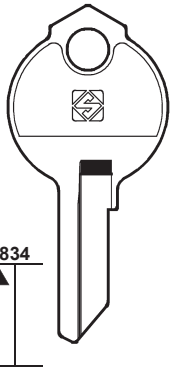

AB100 **AB100R**

AGE

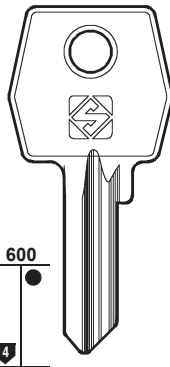

AGB4R

AGE

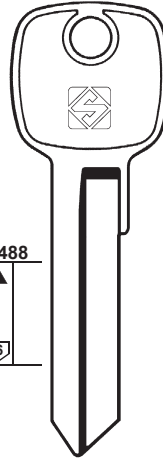

AGE4R

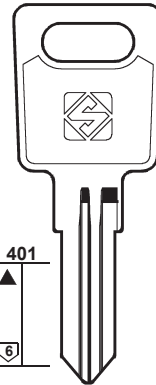

AGE6

PER:
FOR: **ALA**

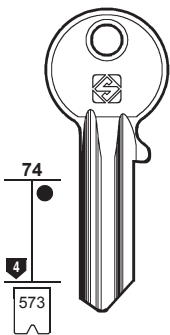

AA3R
.....
1-2-3-4-5-6-7



mm 30

ALPHA

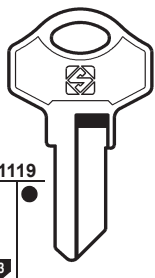

ALP13R

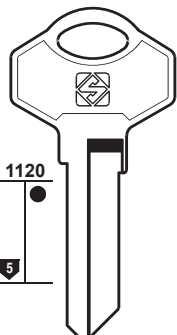

ALP15R

ANCHOR

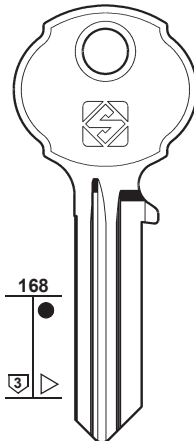

ACR2

ANKERSLOT

ANKERSLOT

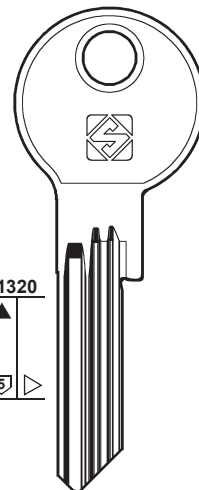

AKR16R

Reinstated key
Chiave ripristinata
Wiedereingeführter Schlüssel
Clé restaurée
Llave restablecida
Chave restabelecida
Terug ingevoerde sleutel



4

PER / FOR

AQUILA (IT)

ARROW (US)

ASSA (SE)

ASTRA (AU)

AUDOLI (IT)

AZBE (ES)

BAB (DE)

BALLY (IT)

+ ZANI (6)

BASSI (IT)

+ GEVY (24)

BECCARINI (IT)

BELL (TW)

PER: AQUILA
FOR:

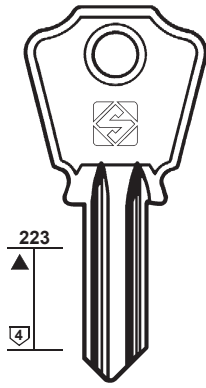

PER: ARROW
FOR:

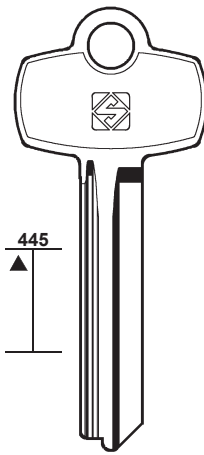

PER: ASSA
FOR:

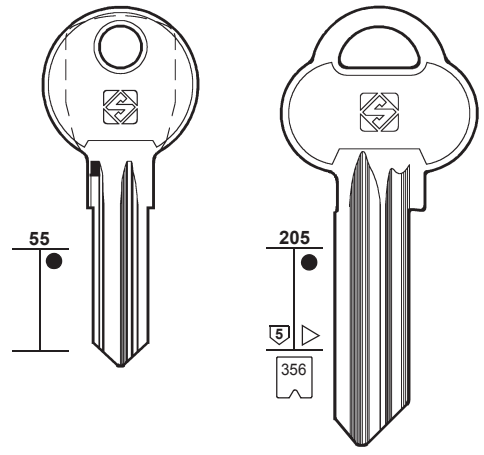

PER: ASTRA
FOR:

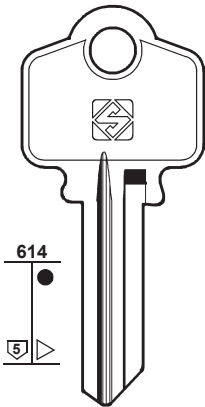

..... 12345678

PER: AUDOLI
FOR:

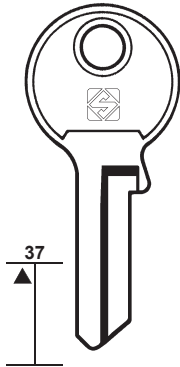

PER: AZBE
FOR:

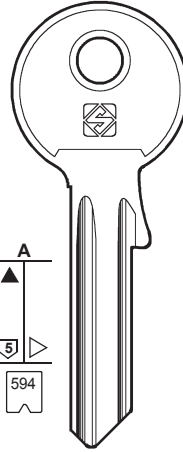

A..... 12345678

PER: BAB
FOR:

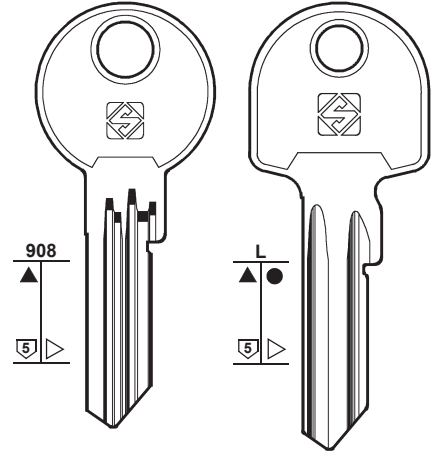

PER: BASSI
FOR:

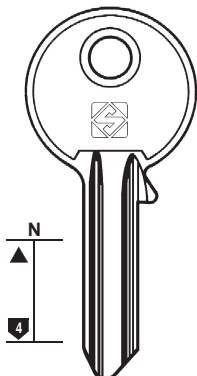

PER: BECCARINI
FOR:

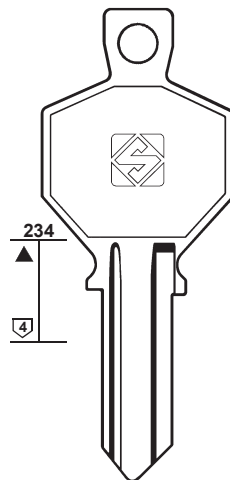

PER: BELL
FOR:

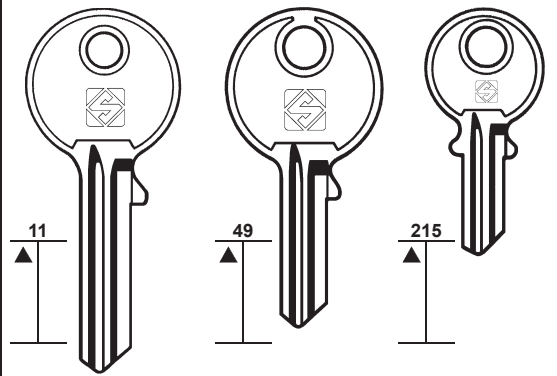

Reinstated key
Chiave ripristinata
Wiedereingeführter Schlüssel
Clé restaurée
Llave restablecida
Chave restabelecida
Terug ingevoerde sleutel

PER:
FOR:

BELLEVILLE

BERTO

BEST

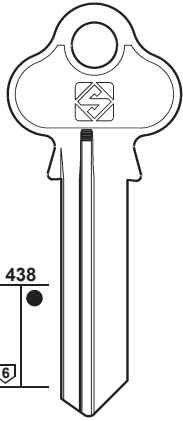
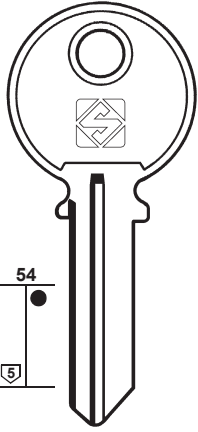

BLV1R

BLV2R

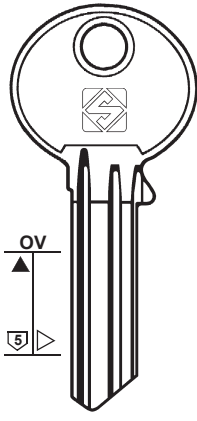

BRT2

BRT3

BRT4

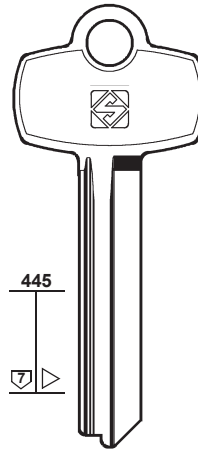

BES16
Q

BES17
R

FALCON



5

PER / FOR

BELLEVILLE (US)

BERTO (CH)

BEST (US)
FALCON

BKS (DE)

BOADEAN (CN)
 CINA (7)

BRISANT (GB)

BRUMME (DE)
 ZEISS IKON (24)

BUFFO (GR)
 ABUS (3)

BULLDOG (GB)

BURG (DE)

PER:
FOR:

BKS

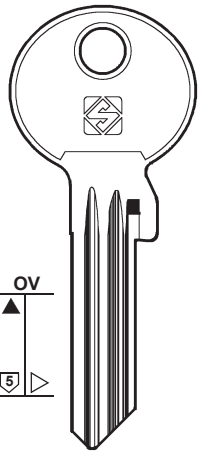

BK48R

BK49R

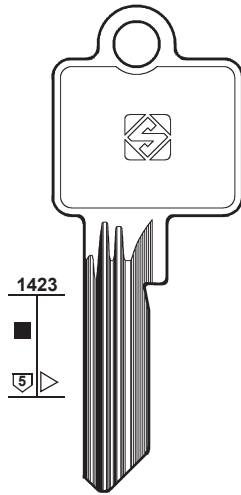

BK52
10

BK53
16

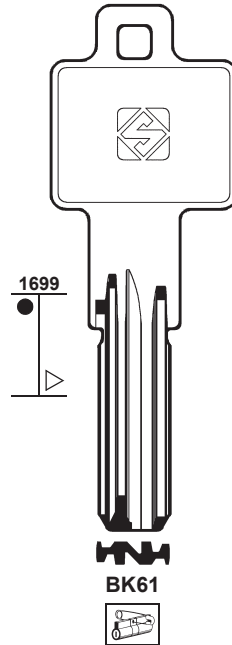

BK61

PER:
FOR:

BRISANT

BULLDOG

BURG

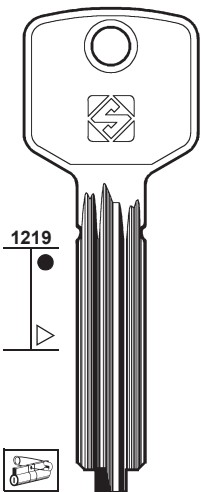

BRS1R

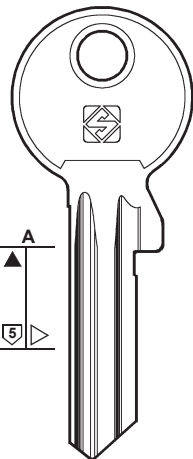

BRS2

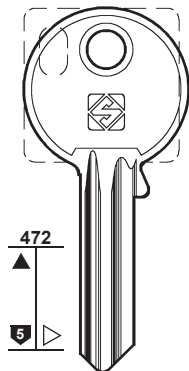

BLG2

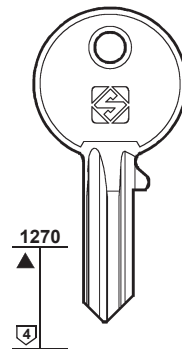

BUR25

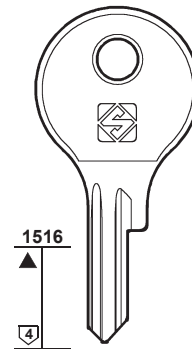

BUR35

Reinstated key
Chiave ripristinata
Wiedereingeführter Schlüssel
Clé restaurée
Llave restablecida
Chave restabelecida
Terug ingevoerde sleutel



6

PER / FOR

BURG (DE)

CARL F (GB)

C.A.R.S. (IT)

O.M.A. (16)

CASMA (IT)

P.C. (CORTELLEZZI) (16)

CES (DE)

PER:
FOR:

BURG

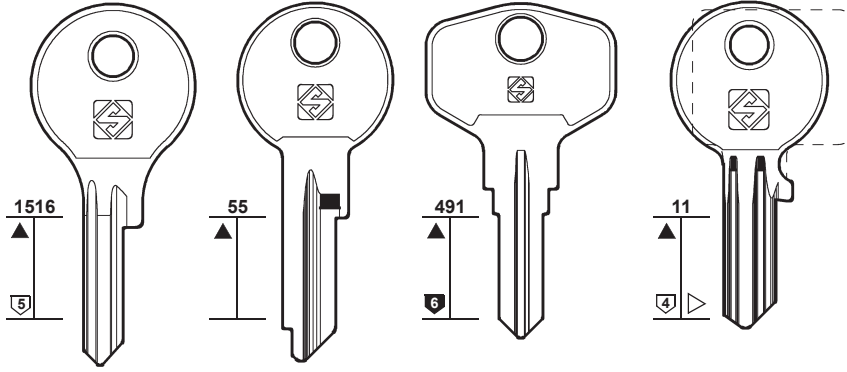

BUR36

BUR60R

BUR61R

BUR62

CARL F

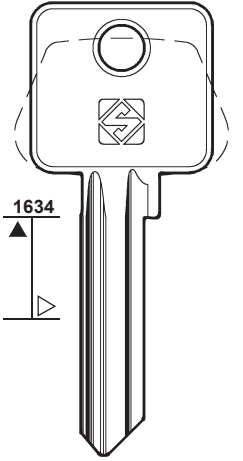

CLF1

PER:
FOR:

CES

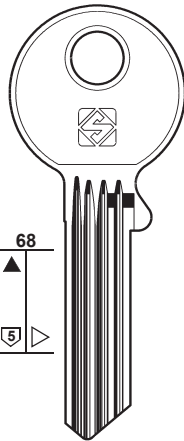

CE17W23

CE17W30

CE17W37

CE17X23

CE17X30

CE17X37

CE17W24

CE17W31

CE17W38

CE17X24

CE17X31

CE17X38

CE17W25

CE17W32

CE17W39

CE17X25

CE17X32

CE17X39

CE17W26

CE17W33

CE17W40

CE17X26

CE17X33

CE17X40

CE17W27

CE17W34

CE17W41

CE17X27

CE17X34

CE17X41

CE17W28

CE17W35

CE17W42

CE17X28

CE17X35

CE17X42

CE17W29

CE17W36

CE17X29

CE17X36

PER:
FOR:

CES

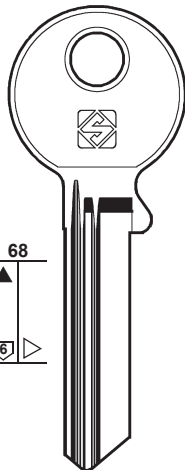

CE38W23

CE38W28

CE38W33

CE38W38

CE38W24

CE38W29

CE38W34

CE38W39

CE38W25

CE38W30

CE38W35

CE38W40

CE38W26

CE38W31

CE38W36

CE38W41

CE38W27

CE38W32

CE38W37

CE38W42

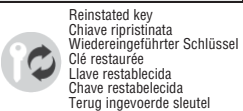

Reinstated key
Chiave ripristinata
Wiedereingeführter Schlüssel
Clé restaurée
Llave restablecida
Chave restabelecida
Terug ingevoerde sleutel

PER: CES CIL LIL CILA-GENTILI
FOR:

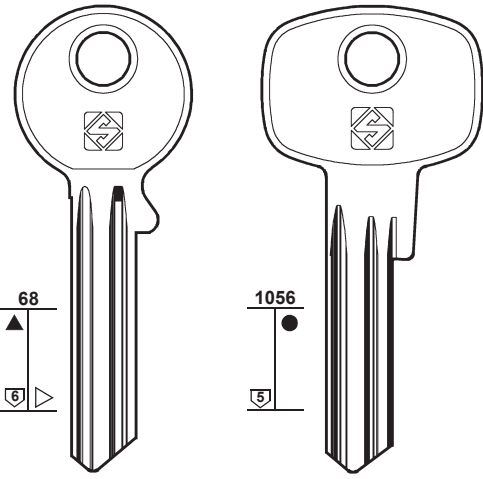

CE149

CE150

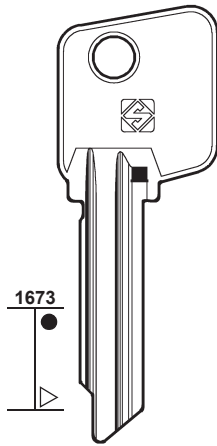

CL1

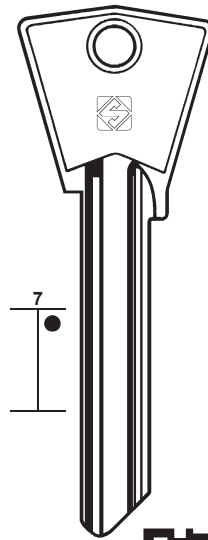

CIL4



7

PER / FOR

CES (DE)

CIL LIL (IL)

CILA-GENTILI (IT)

CINA (CN)

BAODEAN
HOOPLY
MASTER LOCK
MSM

CISA (IT)

ABUS

PER: CINA CISA
FOR:

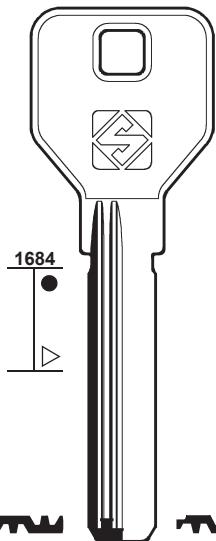

RC8R

RC9R

BAODEAN
MASTER LOCK - MSM

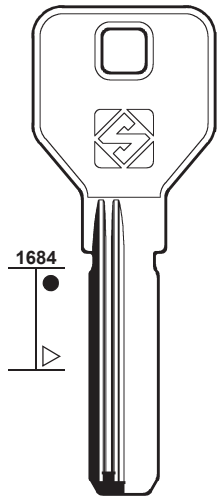

RC10R

BAODEAN - HOOPLY
MASTER LOCK - MSM

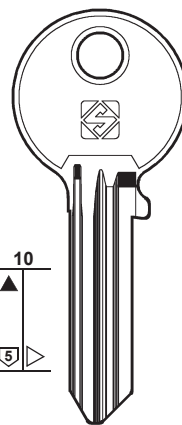

CS162

ABUS

PER: CISA
FOR:

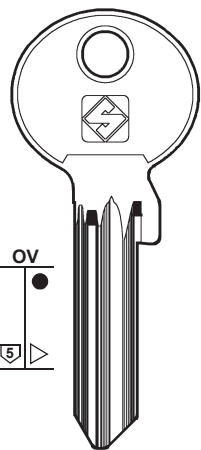

CS163X

ABUS

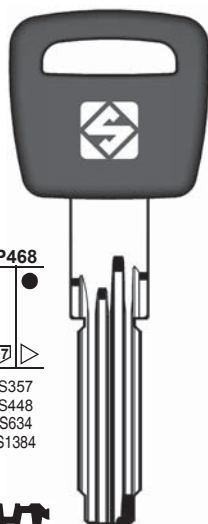

CS62AP

..... 900001-944826
..... (XN008710) 1-11808
..... (XN005710) 1-38832

CS155AP

CS154AP

CS139AP

CS116AP

CS70AP

CS159AP

CS158AP

CS157AP

CS156AP



Reinstated key
Chiave ripristinata
Wiedereingeführter Schlüssel
Clé restaurée
Chiave restablecida
Terug ingevoerde sleutel



8

PER / FOR

CORBIN (IT)

COUILLET (FR)

DEXTER (IT)

PER:
FOR:

CORBIN

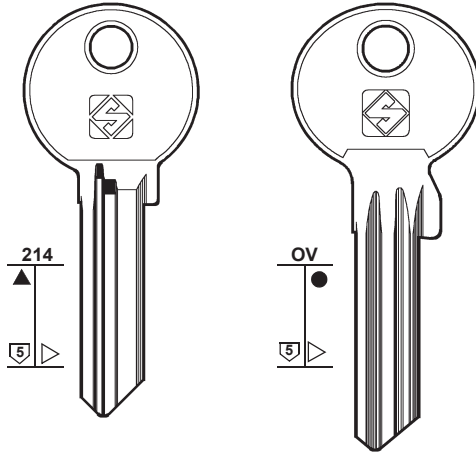

- CB103R
- CB105R
- CB104R
- CB106

COUILLET

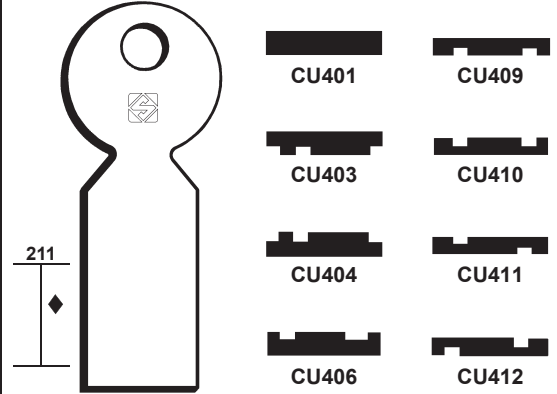

- CU401
- CU409
- CU403
- CU410
- CU404
- CU411
- CU406
- CU412
- CU407
- CU408

All references displayed

PER:
FOR:

DEXTER

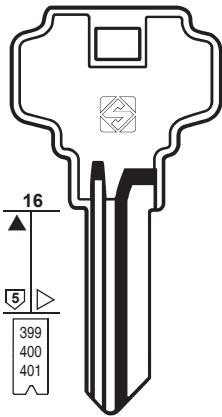

All references displayed

- 0-1-2-3-4-5-6-7
- 0-1-2-3-4-5-6-7
- 0-1-2-3-4-5-6-7-8-9
- T 0-1-2-3-4-5-6-7-8-9

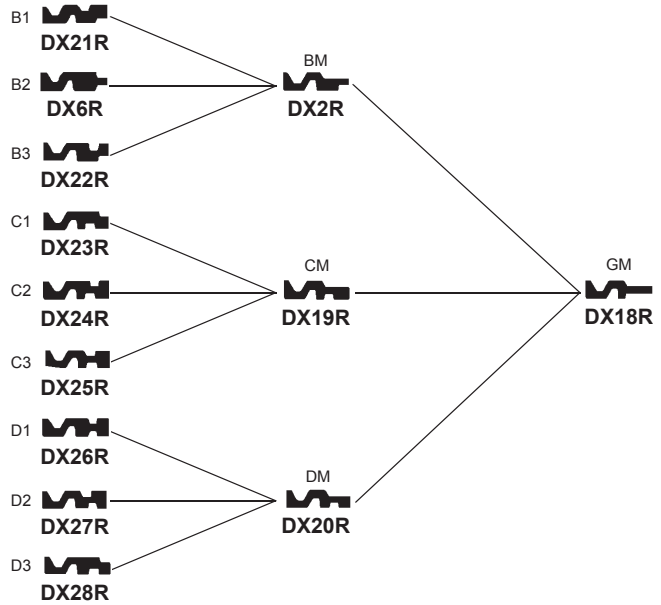

PER:
FOR:

DEXTER

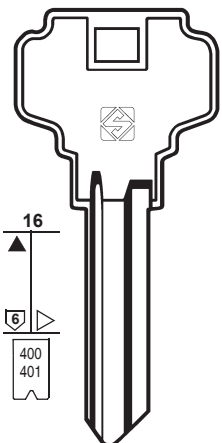

All references displayed

- 0-1-2-3-4-5-6-7
- 0-1-2-3-4-5-6-7-8-9
- T 0-1-2-3-4-5-6-7-8-9

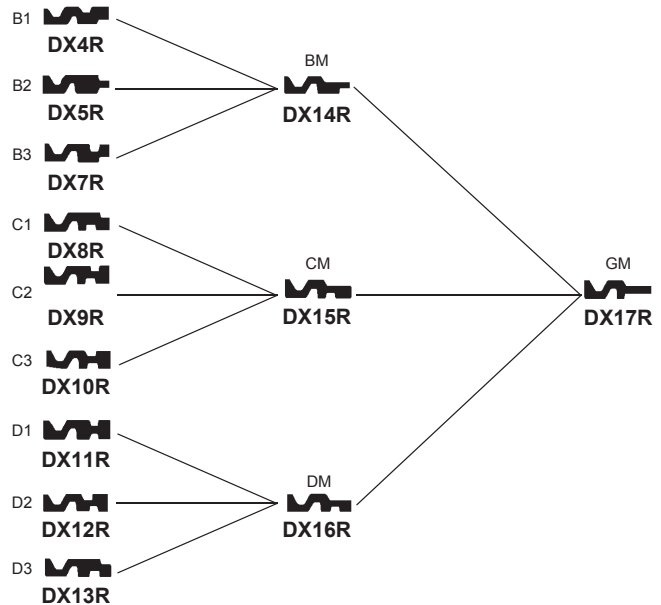

Reinstated key
Chiave ripristinata
Wiedereingeführter Schlüssel
Clé restaurée
Llave restablecida
Chave restabelecida
Terug ingevoerde sleutel

PER:
FOR: **DINBOX**

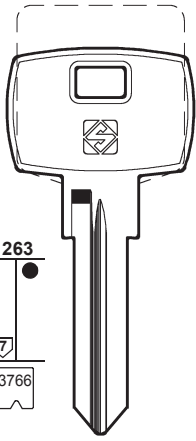

DBX1R
..... 1-2-3

DOM

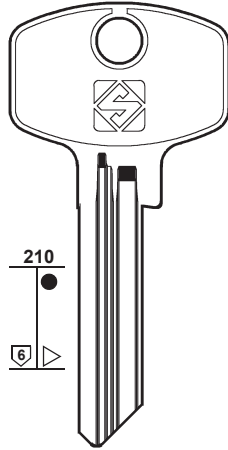

DM80R

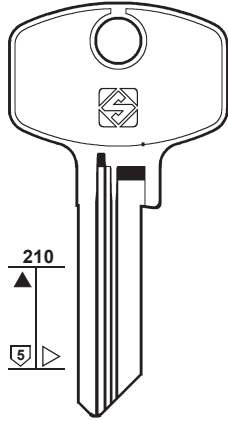

DM50R

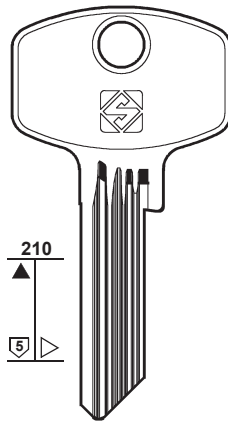

DM151R **DM152**

DM94

DM60R

DM154R **DM154**



9

PER / FOR

DINBOX (SE)

DOM (DE)

EMKA (FR)

ENEL (IT)

ETNA (IT)

EUREKA (IT)
ITALBLOCK

EURO LOCKS (BE)

PER:
FOR: **DOM**

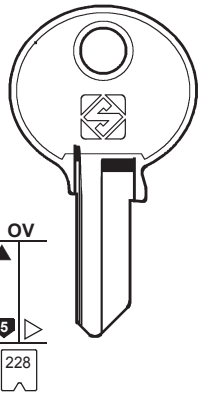

DM123-5

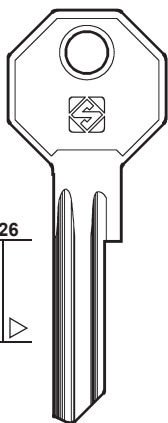

DM155

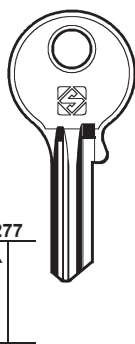

DM153

EMKA

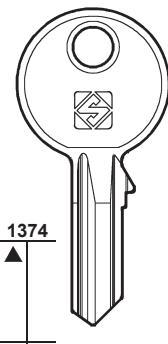

EMK13

ENEL

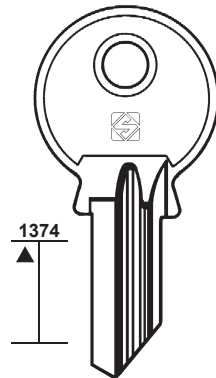

EN2R

PER:
FOR: **ETNA**

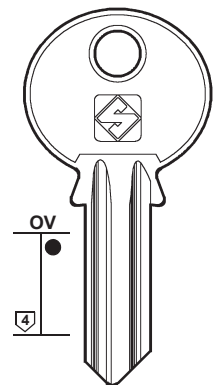

ET2

EUREKA

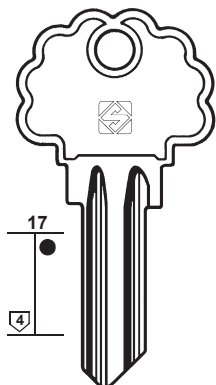

EK2

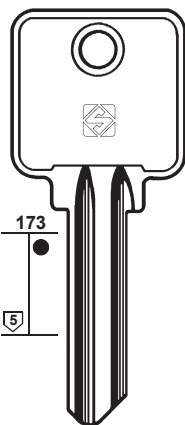

EK4

EURO LOCKS

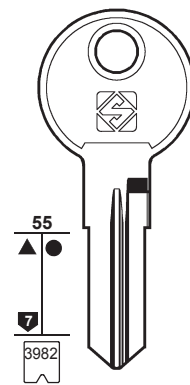

EU20
..... 12345

ITALBLOCK



Reinstated key
Chiave ripristinata
Wiedereingeführter Schlüssel
Clé restaurée
Llave restablecida
Chave restabelecida
Terug ingevoerde sleutel



10

PER / FOR

EURO LOCKS (BE)
HOBBY

EVVA (AT)

FAB (CZ)

F.F. (IT)

FALCON (US)
BEST (5)

FAMA (IT)

FEB (IT)
MORI E. (15)

FERMABLOCK (IT)
OLIVA (16)

FIAM (IT)
MORI E.

FIRST (CH)

FIS (IT)

GEGE (AT)

PER: **EURO LOCKS**

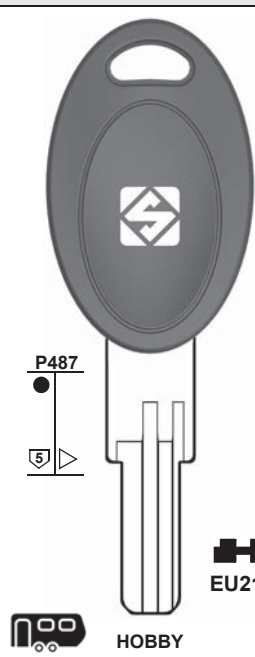

HOBBY

EVVA

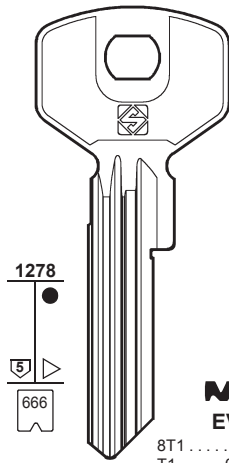

EV70

8T1 00000-99999
T1 00001-68199
T1 68200-99999

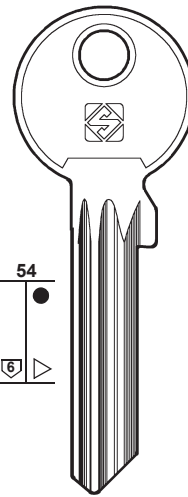

EV70R

OT1 00000-99999
OT 00001-83799
OT 83800-99999

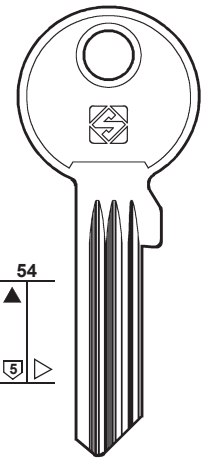

EV109X



EV110RX



EV111RX

PER: **FAB**

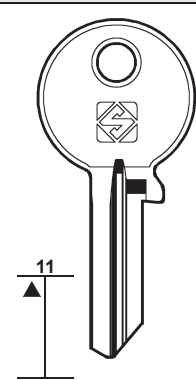

FB83R
82KR

FOR: **F.F.**

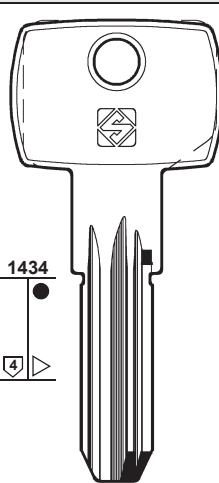

FF19



FAMA

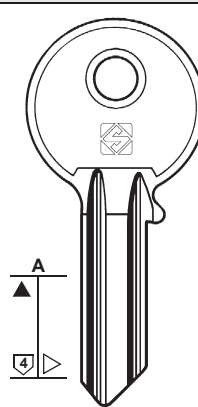

FAM2



FIAM

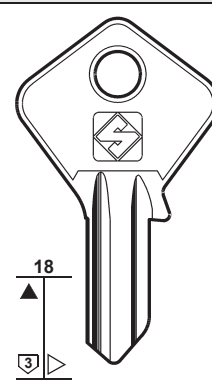

FI1R

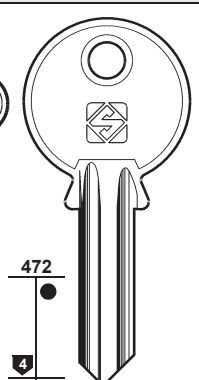

FI2



MORI E.

PER: **FIAM**

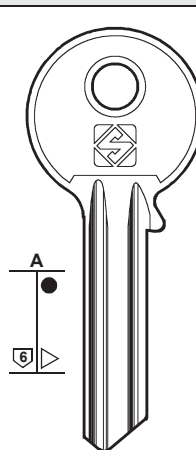

FI6

FOR: **FIRST**

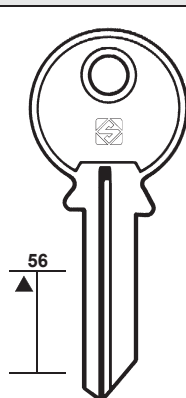

FIR2R



FIS

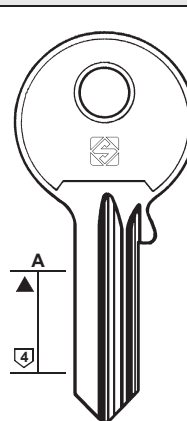

F2R



GEGE

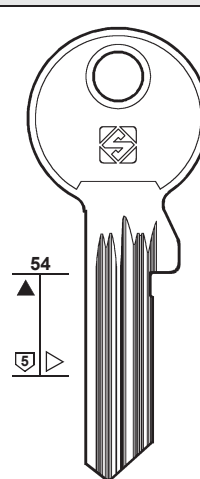

GE178RX-1

GE178RX-2

GE178RX-3

GE178RX-4

GE178RX-5

GE178RX-6

GE178RX-7

Reinstated key
Chiave ripristinata
Wiedereingeführter Schlüssel
Clé restaurée
Llave restablecida
Chave restabelecida
Terug ingevoerde sleutel

PER:
FOR:

GEGE

GERA

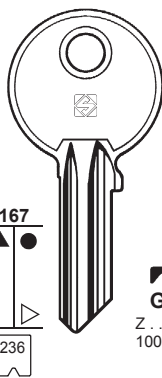
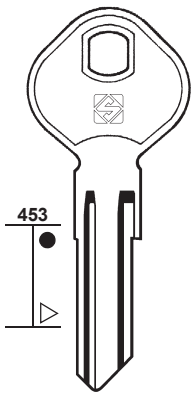

GE18
Z..... (5)
1001-1245

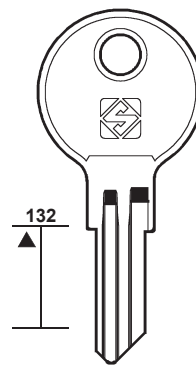
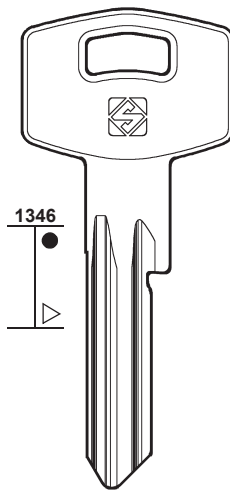

11

PER / FOR

GEGE (AT)

GERA (DE)

GEVY (GR)
BASSI

GUARD (CZ)

HEL (ES)

HOBBY (GB)
EURO LOCKS (10)

HOK (TR)

HOOPLY (CN)
CINA (7)

HTEC (ES)

HUDSON (US)

PER:
FOR:

GERA

GEVY

GUARD

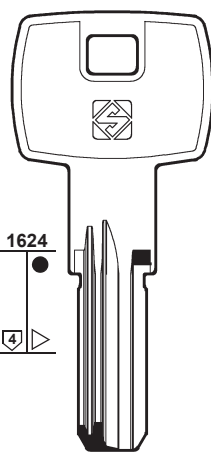
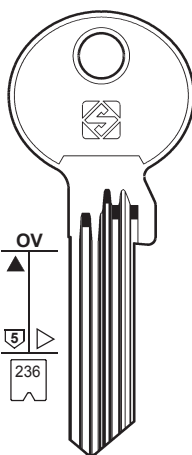

BASSI

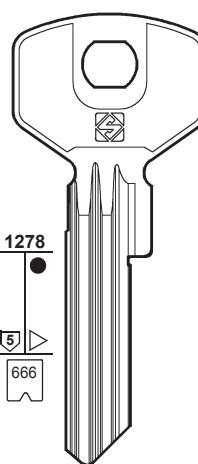

14T1 00000-99999
14T 00001-80000
14T 80001-99999



13T1 00000-99999
13T 00001-80000
13T 80001-99999
13T2 00000-99999

PER:
FOR:

HEL

HOK

HTEC

HUDSON

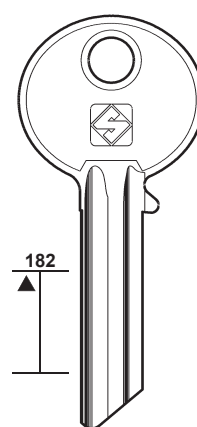
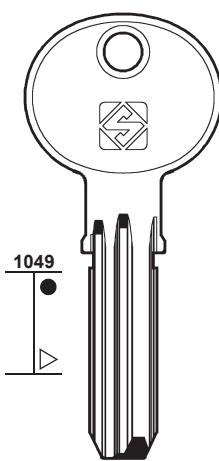
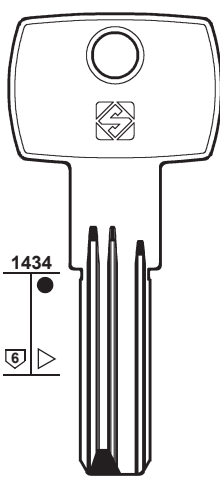
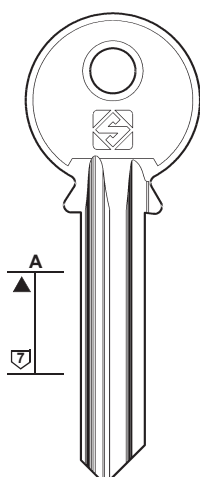

Reinstated key
Chiave ripristinata
Wiedereingeführter Schlüssel
Clé restaurée
Llave restablecida
Chave restabelecida
Terug ingevoerde sleutel



12

PER / FOR

HUGIN (SE)

HUGO (DE)

HUWIL (DE)

IBM (US)

ICSA (IT)

IMSI (IT)

PERINO PG (17)

INSA (IT)

ITALBLOCK (IT)

EUREKA (9)

JUWEL (IT)

PER:
FOR:

HUGIN

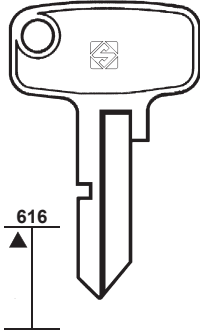

616

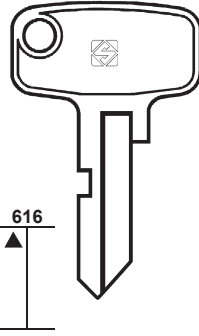

616

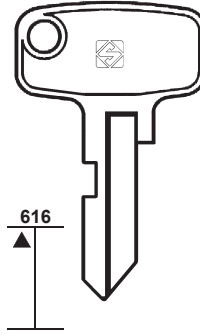

616



HUGO

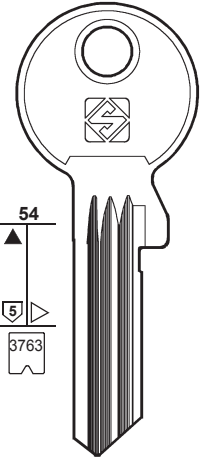

54
5
3763



PER:
FOR:

HUWIL

IBM

ICSA

INSA

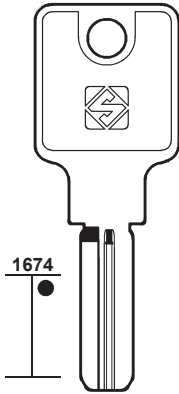

1674

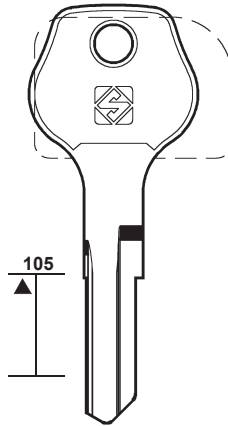

105

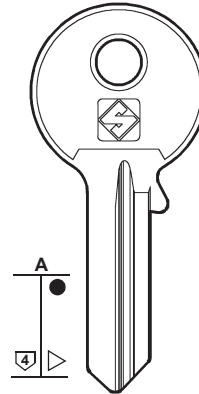

A
4

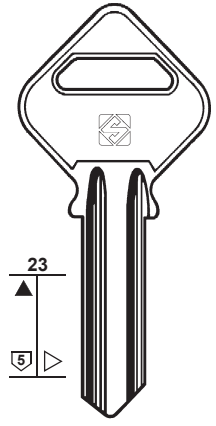

23
5



PER:
FOR:

ISEO

JUWEL

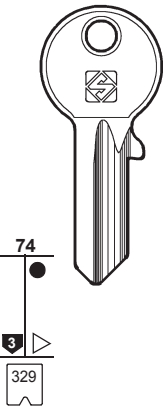

74
3
329



IE5R
... 1-2-3-4-5

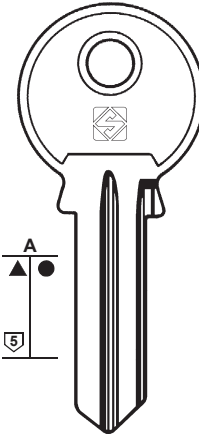

A
5



All references displayed
1 JW4 4 JW5R 6 JW6R

15 JW13R
JW10R
JW10
53 JW9R

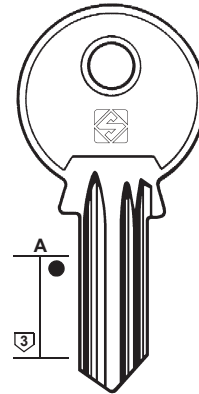

A
3



JW3R

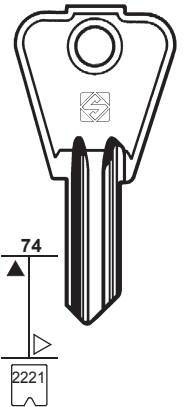

74
2221



JW14
... 123456

Reinstated key
Chiave ripristinata
Wiedereingeführter Schlüssel
Clé restaurée
Llave restablecida
Chave restabelecida
Terug ingevoerde sleutel

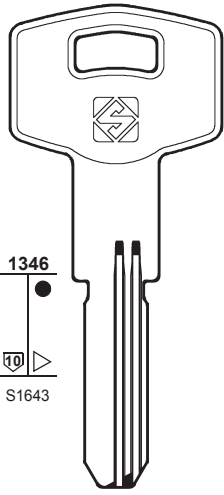
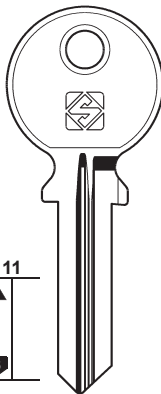
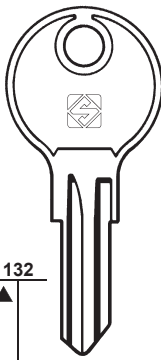
<p>PER: FOR:</p> <p style="text-align: center;">KALE</p>  <p>1346 S1643</p> <p style="text-align: center;">KLE11</p>	<p style="text-align: center;">KEYA</p>  <p>11 6</p> <p style="text-align: center;">KEY2</p>	<p style="text-align: center;">KING</p>  <p>132</p> <p style="text-align: center;">KG1</p>
---	---	--





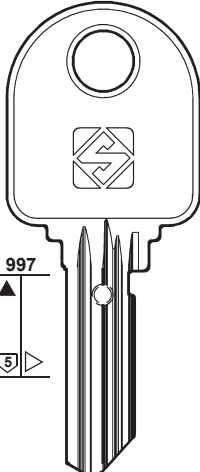
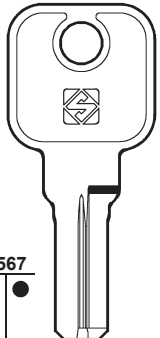
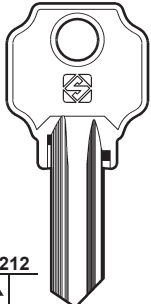
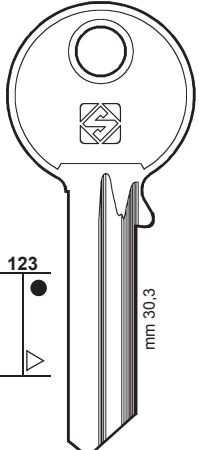

13

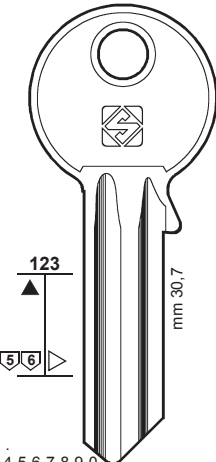
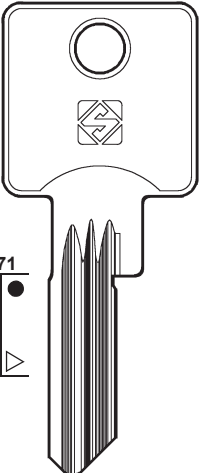
PER / FOR
KALE (TR)
KARDEX (FR) VINCO (22)
KEYA (ES)
KING (TW)
LAPERCHE (FR)
LEHMANN (FR) MLM
LINCE (ES)
LIPS (NL)
LITTO (BE)

<p>PER: FOR:</p> <p style="text-align: center;">LAPERCHE</p>  <p>997 5</p> <p style="text-align: center;">LH43R</p>	<p style="text-align: center;">LEHMANN</p>  <p>1567 S1559</p> <p style="text-align: center;">MLM9</p> <p style="text-align: center;">MLM</p>	<p style="text-align: center;">LINCE</p>  <p>1212 5</p> <p style="text-align: center;">LC9</p> <p style="text-align: center;">mm 30-40</p>	<p style="text-align: center;">LIPS</p>  <p>123 mm 30,3</p> <p style="text-align: center;">LP37R 34C</p>
---	---	--	--

<p>PER: FOR:</p> <p style="text-align: center;">LIPS</p>  <p>123 mm 30,7</p> <p style="text-align: center;">LP53 28F</p> <p>..... 1-2-3-4-5-6-7-8-9-0 A-B-C-D-E-F-G-H-I-L</p>	<p style="text-align: center;">LITTO</p>  <p>471</p> <p style="text-align: center;">LT6R</p>
--	---

All references displayed

- 45F  **LP45**
- 45E  **LP44**
- 45D  **LP43**
- 45C  **LP42**
- 45B  **LP41**

Reinstated key
Chiave ripristinata
Wiedereingeführter Schlüssel
Clé restaurée
Llave restablecida
Chave restabelecida
Terug ingevoerde sleutel



14

PER / FOR

LOB (PL)

L & F (GB)

MASTER (US)

MASTER LOCK (TW)
+ CINA (7)

MG (MONTI) (IT)

MICHEL-SEAT (IT)
POTENT

PER:
FOR:

LOB

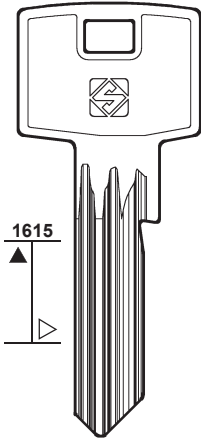

LOB7

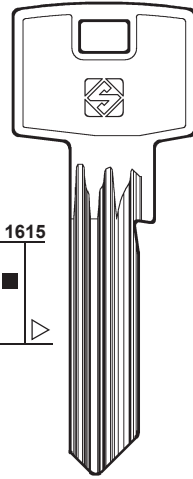

LOB8

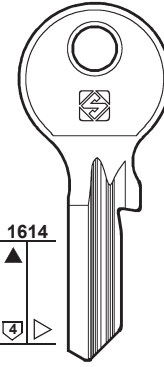

LOB9R

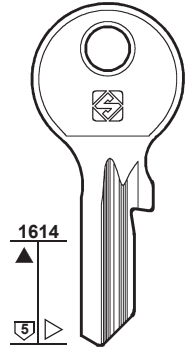

LOB10R

PER:
FOR:

LOB

LOWE & FLETCHER

MASTER

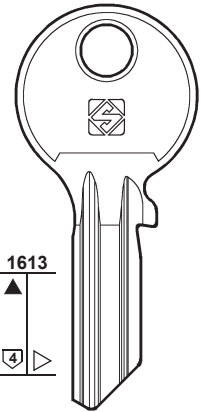

LOB13

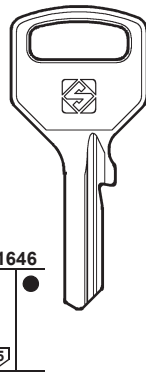

LOB11R

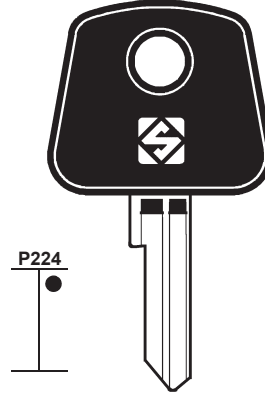

LF4AP

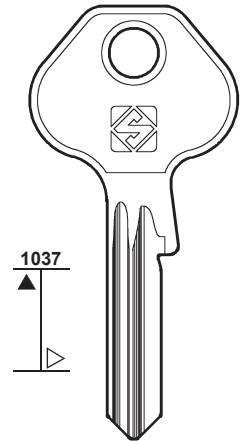

MS24

PER:
FOR:

MASTER LOCK

MG (MONTI)

MICHEL-SEAT

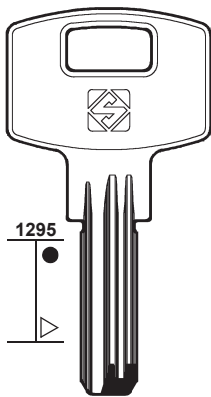

MSL2

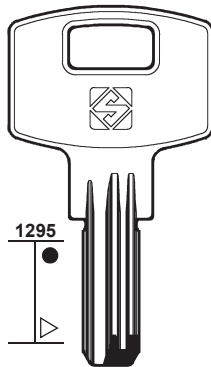

MSL3

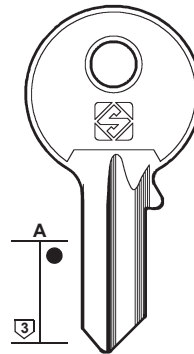

MG3R

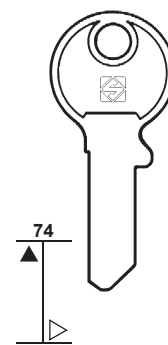

MH3

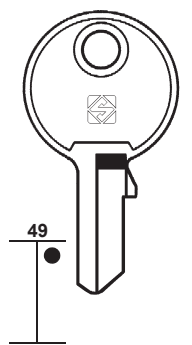







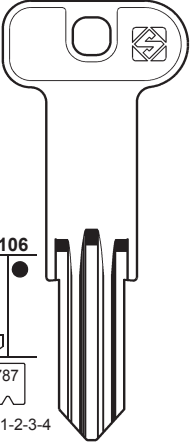

MH5

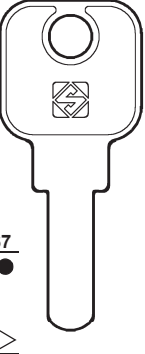
POTENT

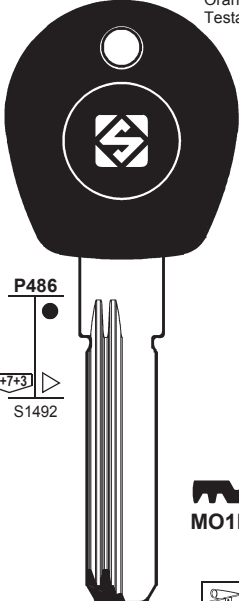

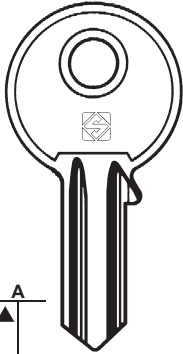
Reinstated key
Chiave ripristinata
Wiedereingeführter Schlüssel
Clé restaurée
Llave restablecida
Chave restabelecida
Terug ingevoerde sleutel











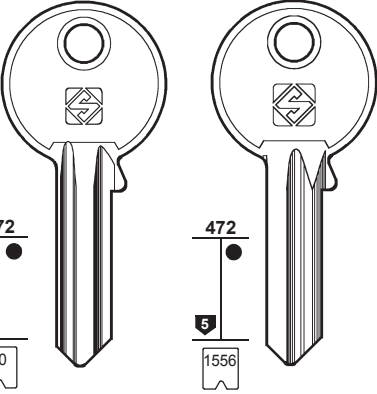

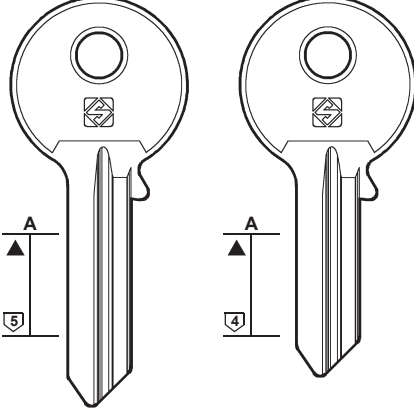
<p>PER: FOR:</p> <p>MIWA</p>  <p>1106 787 1-2-3-4</p>  <p>MIW4</p>	<p>MLM</p>  <p>4567</p>  <p>MLM15</p>	<p>MOIA</p> <p>Orange head Testa arancione</p>  <p>P486 4+7+3 S1492</p>  <p>MO1RP</p>	<p>MONTI-MG</p>  <p>A 3</p>  <p>MN4</p>
---	---	---	---

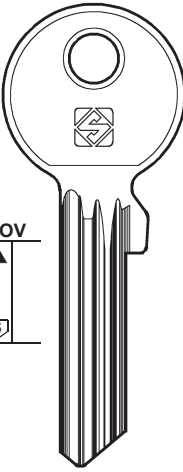

15

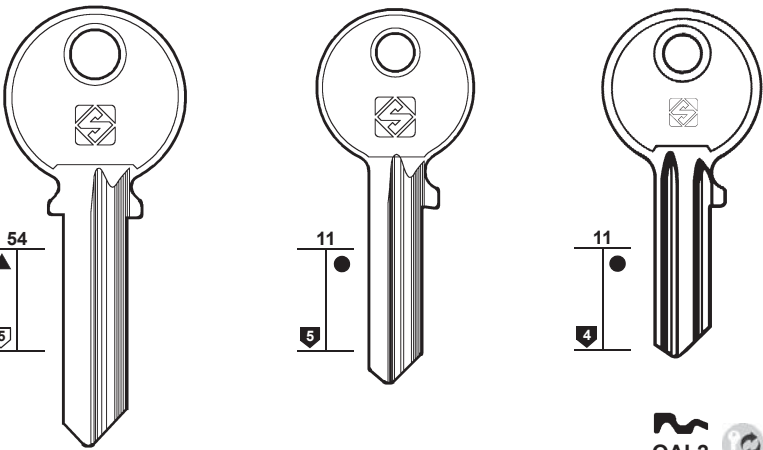
PER / FOR
MIWA (JP)
MLM (DE) +  LEHMANN (13)
MOIA (IT)
MONTI-MG (IT)
MORI E. (IT) FEB +  FIAM (10)
MORI G. (IT)
MSM (CN)  CINA (7)
NEMEF (NL)
OAL (IT)
OJMAR (ES)

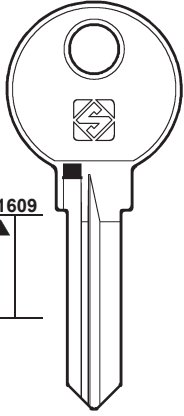
<p>PER: FOR:</p> <p>MORI E.</p>  <p>472 40 1556</p>  <p>MI8 G... 1-78</p> <p>MI3R 1-2-3-4-5-6</p> <p>FEB</p>	<p>MORI G.</p>  <p>A 5 4</p>  <p>MIG1R</p> <p>MIG2R</p>	<p>NEMEF</p>  <p>ov 5</p>  <p>NME3</p>
---	---	---

<p>PER: FOR:</p> <p>OAL</p>  <p>54 11 11</p>  <p>OAL4R</p> <p>OAL3R</p> <p>OAL2R</p> <p>OAL2</p>	<p>OJMAR</p>  <p>1609</p>  <p>OJ17R</p>
---	---

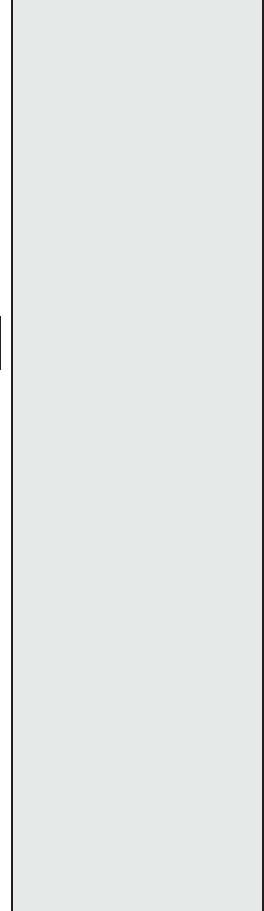

 Reinstated key
 Chiave ripristinata
 Wiedereingeführter Schlüssel
 Clé restaurée
 Llave restablecida
 Chave restabelecida
 Terug ingevoerde sleutel



16

PER / FOR

OLIVA (IT)
FERMABLOCK
PB
PREFER

O.M.A. (IT)
C.A.R.S.

OMEC (IT)

OTIS (IT)
ZEISS IKON (24)

PB (IT)
OLIVA (16)

P.C. (CORTELLEZZI) (IT)
CASMA

Reinstated key
Chiave ripristinata
Wiedereingeführter Schlüssel
Clé restaurée
Llave restablecida
Chave restabelecida
Terug ingevoerde sleutel

PER: FOR:	OLIVA	O.M.A.	OMEC
	 A 5 OL4R OL3R OL3 OL2R OL6R OL1 OL1R OL2	 A 4 OA3	 29 4 333 334 OC1R ... 1-2-3-4-5
	FERMABLOCK - PB - PREFER		C.A.R.S.

PER: FOR:	OMEC	P.C. (CORTELLEZZI)				
	 29 3	 Y 4	 378 3	 D 3	 197 3	 232 3 336 ... 1-2-3-4-5
	OC2R	PC11R	PC5	PC9	PC7	PC3
		CASMA				

PER: FOR:	P.C. (CORTELLEZZI)			
	 A 5	 E 5	 E 4	 A 5
	PC26	PC27	PC28	PC31R

PER: **P.C. (CORTELLEZZI)** **PERINO PG** **PFAFFENHAIN**
 FOR:

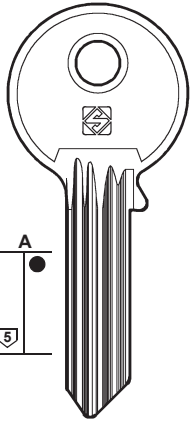

PC33

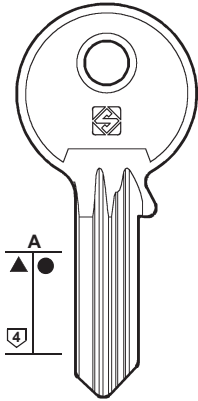

PC33R

PC32R

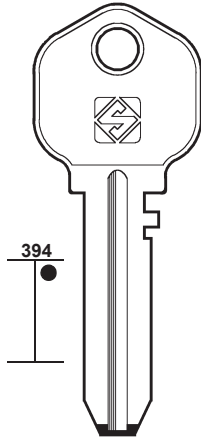

PN1R

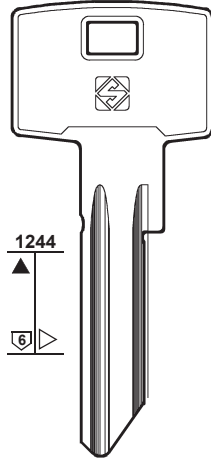

PHF32



17

PER / FOR

P.C. (CORTELLEZZI) (IT)

PERINO PG (IT)
IMSI

PFAFFENHAIN (DE)

POTENT (IT)
+ MICHEL-SEAT (14)

PREFER (IT)
+ OLIVA (16)

RABBIT (HK)

RENZ (DE)

ROMA (IT)

RONIS (FR)

PER: **PFAFFENHAIN** **POTENT** **PREFER**
 FOR:

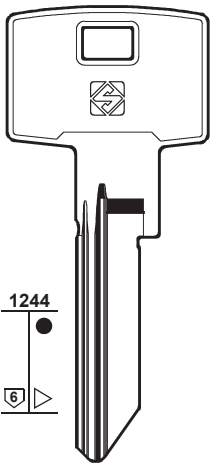

PHF26

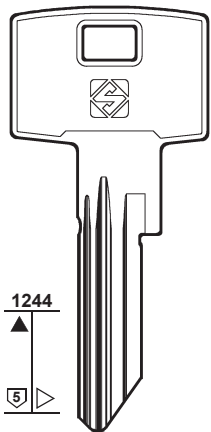

PHF26R

PHF29

PHF28R

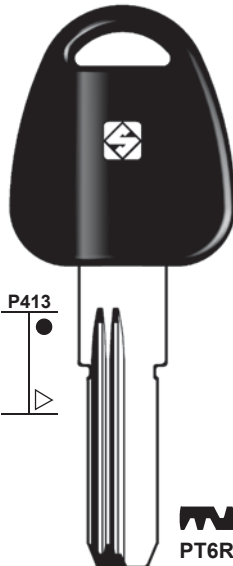

PT6RP

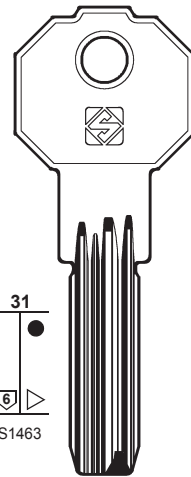

PF21

PHF27

PHF27R

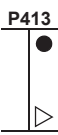

PER: **RABBIT** **RENZ** **ROMA** **RONIS**
 FOR:

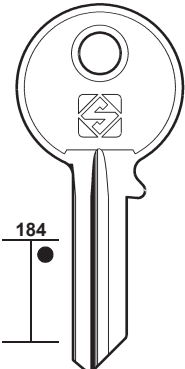

RBT1R

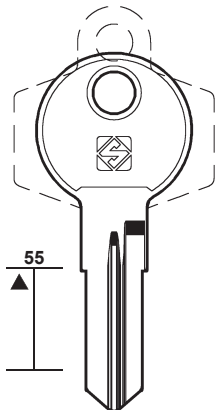

REN5

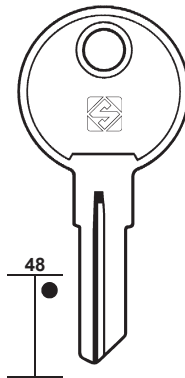

RA1R

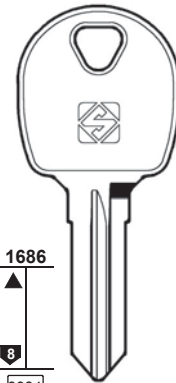

RO84

..... 12345

Reinstated key
 Chiave ripristinata
 Wiedereingeführter Schlüssel
 Clé restaurée
 Llave restablecida
 Chave restabelecida
 Terug ingevoerde sleutel



18

PER / FOR

ROYAL (TW)

RUKO (DK)

SECUREMME (IT)

SFB (SE)

SHOWA (JP)

SIL (PT)

SQUIRE & SONS (GB)

STS (ES)

STUV (DE)

PER: ROYAL
FOR:

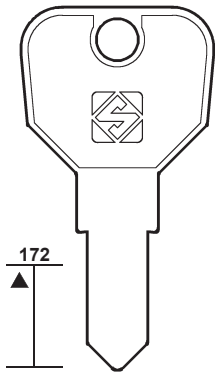

ROY1

PER: RUKO
FOR:

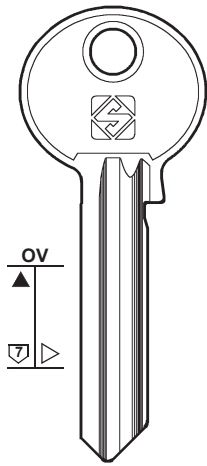

RU29R
GK

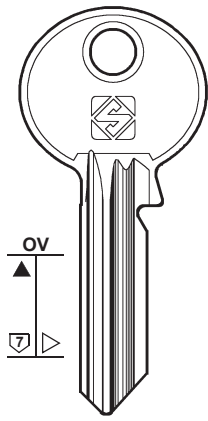

RU30
TL

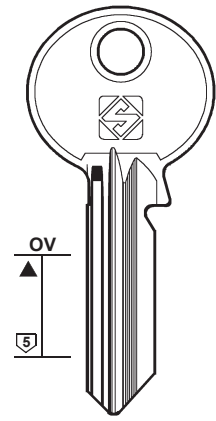

RU4

PER: SECUREMME
FOR:

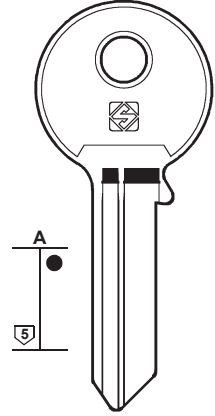

SCM4

PER: SFB
FOR:

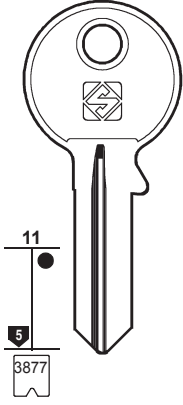

SFB1R
..... 1234

PER: SHOWA
FOR:

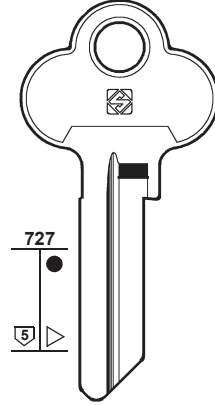

SWA9R

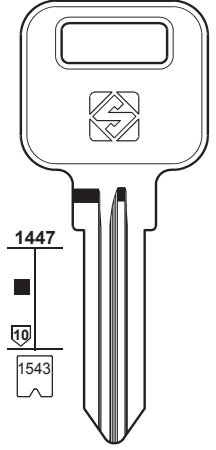

SWA13R
..... 0123

PER: SIL
FOR:

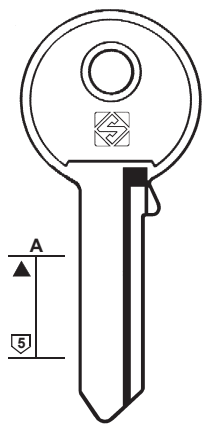

SIL1

PER: SQUIRE & SONS
FOR:

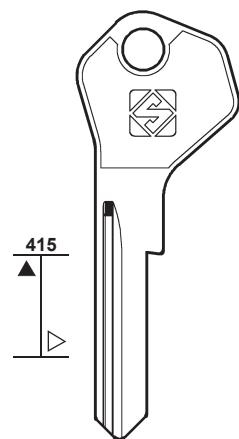

SQ6R

PER: STS
FOR:

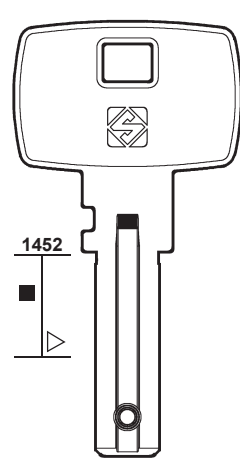

STS12

PER: STUV
FOR:

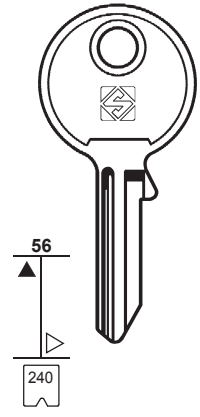

SV5

Reinstated key
Chiave ripristinata
Wiedereingeführter Schlüssel
Clé restaurée
Llave restablecida
Chave restabelecida
Terug ingevoerde sleutel

PER:
FOR: **SÜDMETALL**

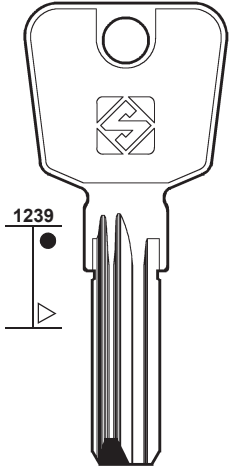

1239



SDT1R



SWEDA

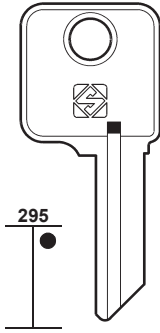

295



SW1R
Z



SW2
X



TARONI

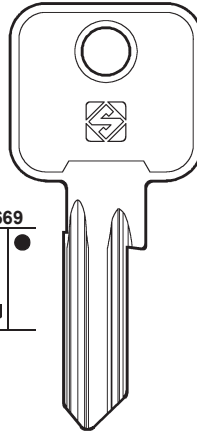

669



TAR26

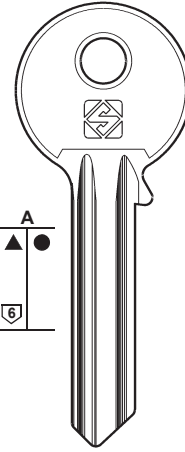

A

6



TAR11



TAR11R



19

PER / FOR

SÜDMETALL (DE)

SWEDA (IT)

TARONI (IT)

TOKOZ (CZ)

PER:
FOR: **TARONI**

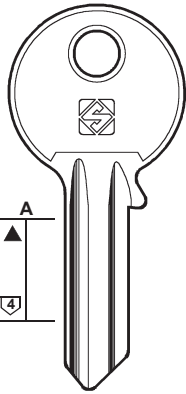

A

4



TAR9



TAR9R

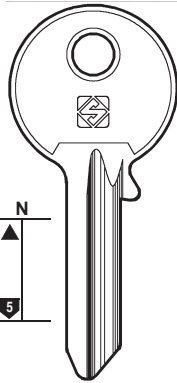

N

5



TAR8R



74

3



TAR7



TAR7R

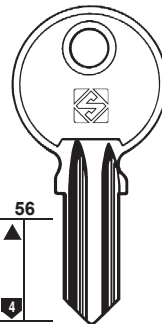

56

4



TAR6



TAR6R

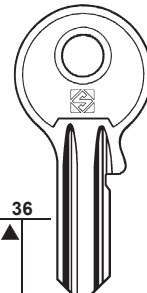

36

3



TAR10



TAR10R



PER:
FOR: **TOKOZ**

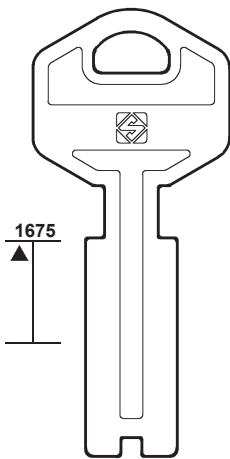

1675

TOZ6

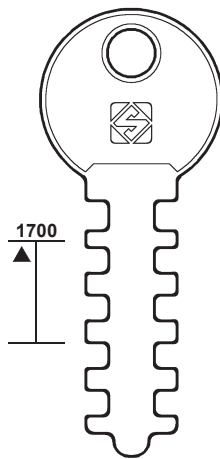

1700

TOZ13

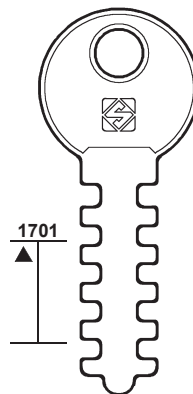

1701

TOZ14



Reinstated key
Chiave ripristinata
Wiedereingeführter Schlüssel
Clé restaurée
Llave restablecida
Chave restabelecida
Terug ingevoerde sleutel



20

PER / FOR

TOK-WINKHAUS (DE)

TRELOCK (DE)

PER:
FOR:

TOK-WINKHAUS

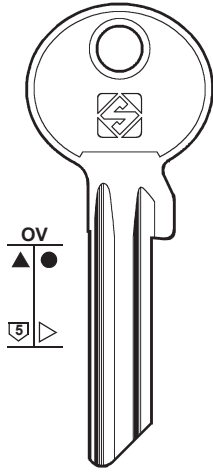

TO29X

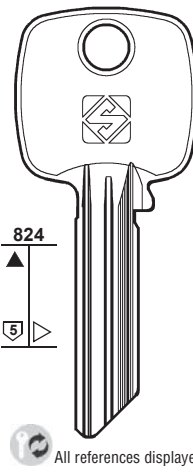

TO50X9 **TO50X12** **TO50X16**

TO50RX1

TO50RX3

TO50RX8

TO50RX10

TO50RX11

TO50RX12

TO50RX13

TO50RX14

TO50RX15

TO50RX16

TO50RX17

TO50RX18

All references displayed

PER:
FOR:

TOK-WINKHAUS

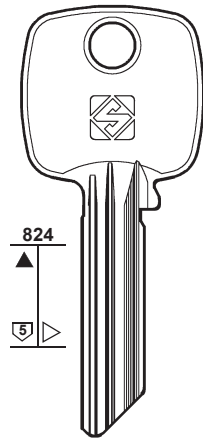

All references displayed

TO51Y4

TO51Y12

TO51Y13

TO51Y15

TO51Y16

TO51Y17

TO51RY2

TO51RY3

TO51RY5

TO51RY7

TO51RY8

TO51RY9

TO51RY10

TO51RY11

TO51RY12

TO51RY13

TO51RY14

TO51RY15

TO51RY16

TO51RY17

TO51RY18

PER:
FOR:

TRELOCK

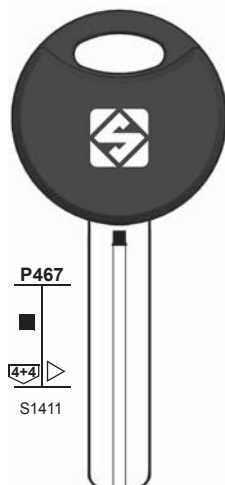

TRK8DP

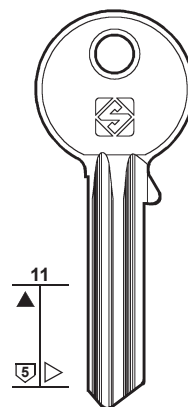

TRK9 **TRK9R**

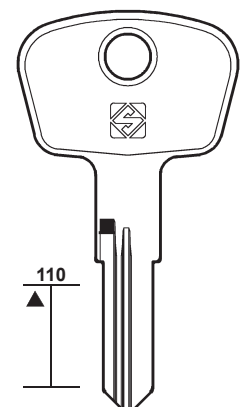

TRK10 **TRK10R**

Reinstated key
Chiave ripristinata
Wiedereingeführter Schlüssel
Clé restaurée
Llave restablecida
Chave restabelecida
Terug ingevoerde sleutel



PER: TRI-CIRCLE UMF UNION
FOR:

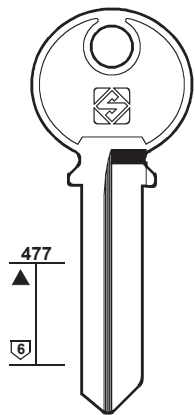

TL16R

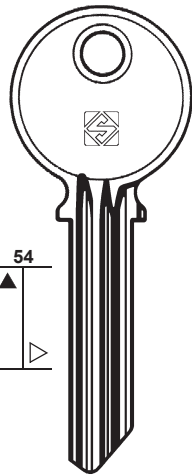

UM1R

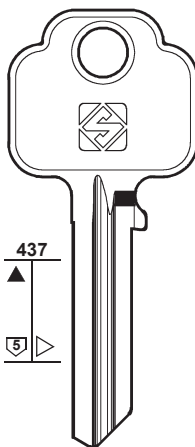

- 909 UNI41
- 508 UNI40R
- 908 UNI40
- 505 UNI37R
- 506 UNI38R



21

PER / FOR
TRI-CIRCLE (TW)
UMF (PT)
UNION (GB)
UNIVERSAL
VACHETTE (FR)

PER: UNION UNIVERSAL
FOR:

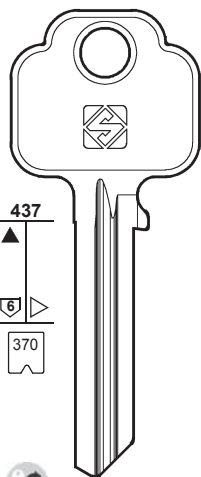

- 509 UNI52R
- 507 UNI50R
- 506 UNI49R
- 505 UNI48R
- 909 UNI52
- 504 UNI47R
- 906 UNI49
- 501 UNI44R
- 503 UNI46R
- 905 UNI48

All references displayed

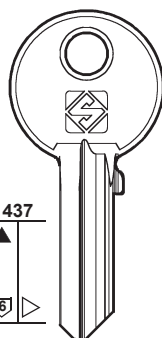

- UNI56R
 - UNI58R
- NKW/X ... 101-200
NKW/A ... 101-200
NKW/A ... 1101-1200

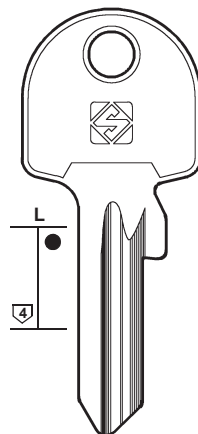

UL053XL

PER: UNIVERSAL VACHETTE
FOR:

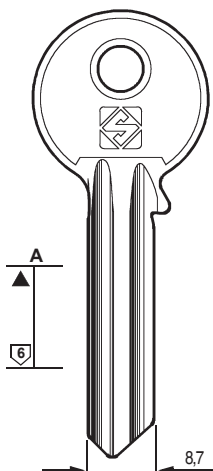

UL064

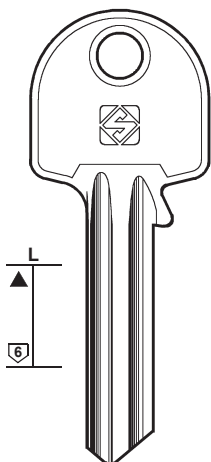

UL064L

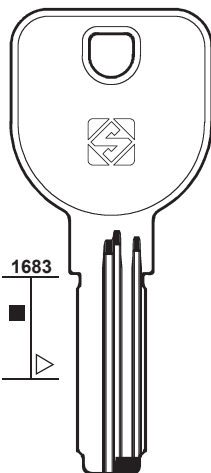

VAC152

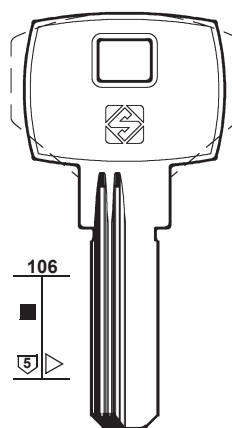

VAC153R



Reinstated key
Chiave ripristinata
Wiedereingeführter Schlüssel
Clé restaurée
Llave restablecida
Chave restabelecida
Terug ingevoerde sleutel



22

PER / FOR

VAN VAULT (GB)

VEROFER (RO)

V.G.F. VILLATORE (IT)

VINCO (DE)
KARDEX

WALLY (IT)

WELKA (IT)

WESLOCK (DE)

WILKA (DE)

PER: VAN VAULT

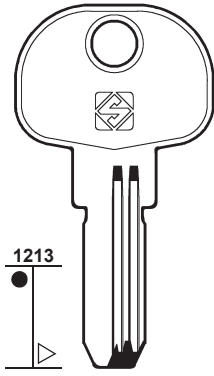

VAV1



VEROFER

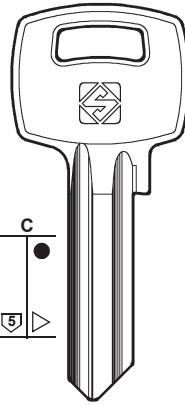

VRF3

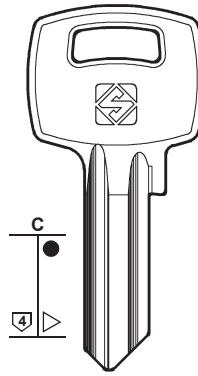

VRF4

V.G.F. VILLATORE

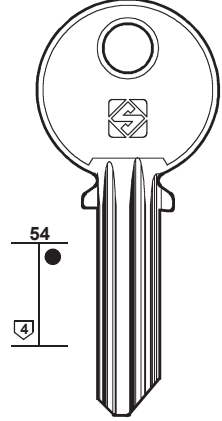

VL1R



PER: VINCO

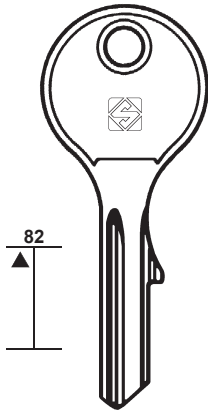

VN1R



KARDEX

WALLY

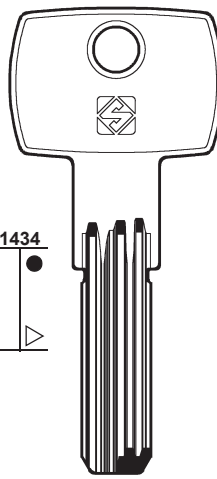

WA8



WELKA

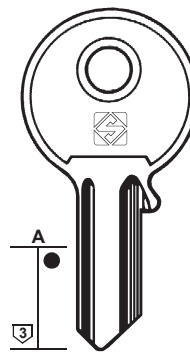

WE6



WE6R

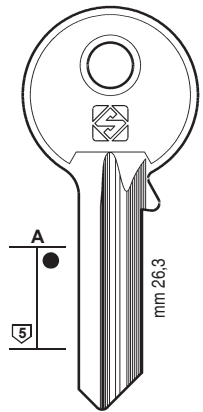

WE14R



PER: WELKA

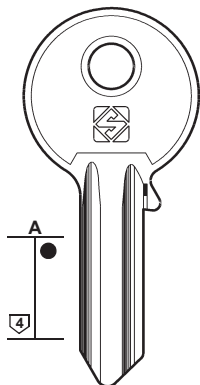

WE13



WE13R



WE12R



WE15



WESLOCK

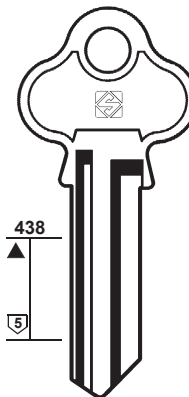

WS3



WILKA

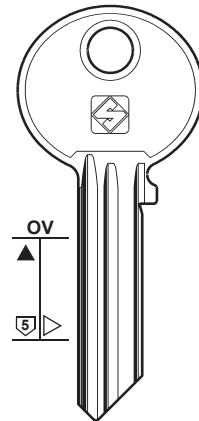

WK57

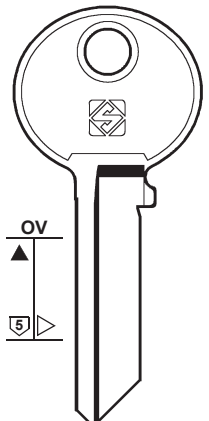

WK62R

Reinstated key
Chiave ripristinata
Wiedereingeführter Schlüssel
Clé restaurée
Llave restablecida
Chave restabelecida
Terug ingevoerde sleutel

PER:
FOR:

WILKA

W.M.S.

YALE

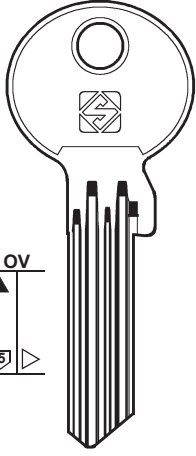

WK87X

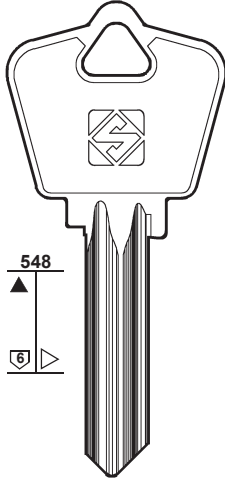

WMS3

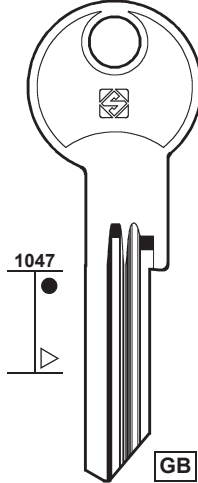

YA98R

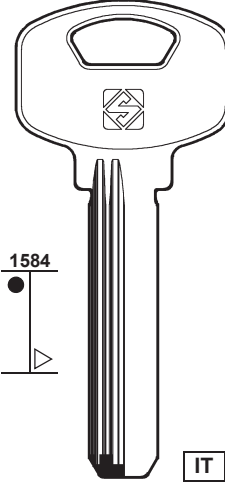

YA99R



23

PER / FOR

WILKA (DE)

W.M.S. (GB)

YALE (GB) (IT) (US)

PER:
FOR:

YALE

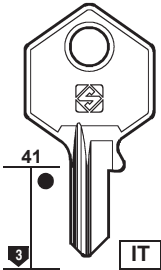

YA33R

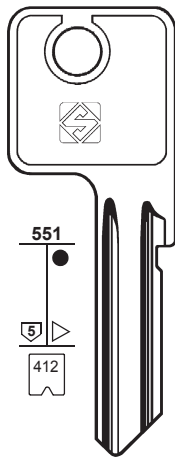

YA38

..... 0123456789
A..... 0123456789

US

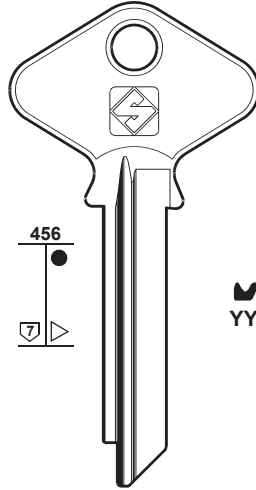

US

YYP7R



YYA7



YB7



YYC7



YYD7



YYE7



YYF7



YYG7



YYH7



YYK7

All references displayed



MIGNON

PER:
FOR:

YALE

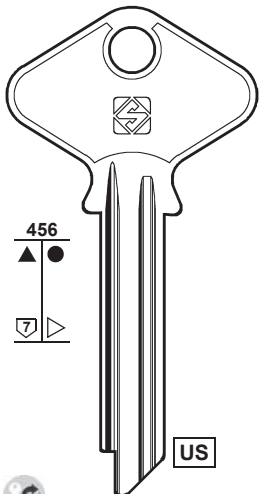

VA

VYA7

VB

VYB7

VC

VYC7

VD

VYD7

VE

VYE7

VF

VYF7

VG

VYG7

VH

VYH7

VK

VYK7

GH

GYH7

GGB

GYGB7

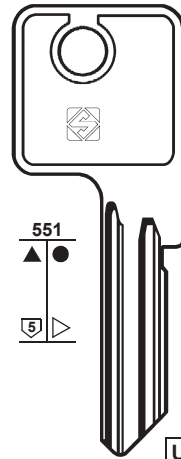

GA

GYA8

GB

GYB8

GC

GYC8

GD

GYD8

GE

GYE8

GG

GYG8

GH

GYH8

GK

GYK8

VA

VYA8

VB

VYB8

VC

VYC8

VD

VYD8

VE

VYE8

VF

VYF8

VG

VYG8

VH

VYH8

VK

VYK8

All references displayed



Reinstated key
Chiave ripristinata
Wiedereingeführter Schlüssel
Clé restaurée
Llave restablecida
Chave restabelecida
Terug ingevoerde sleutel



24

PER / FOR

ZANI (IT)
BALLY

ZEISS IKON (DE)
BRUMME
OTIS

ZOO (GB)

GERA (DE)

MOBELLA (SE)

PER:
FOR:

ZANI

ZEISS IKON

ZOO

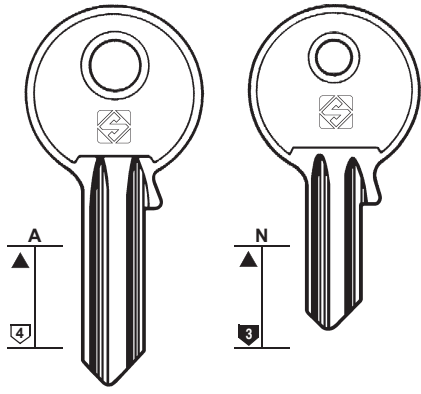

ZI2



ZI3

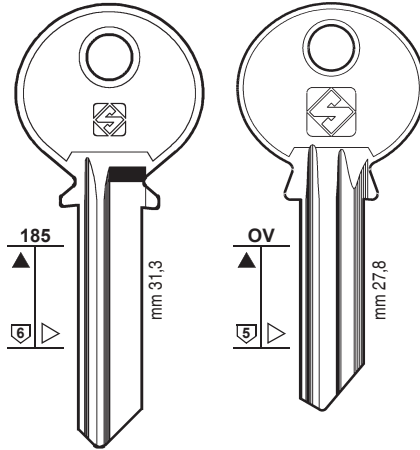

ZE46



ZE46R



ZE39R
SN4

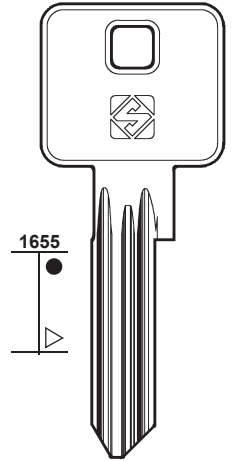

Z01

BALLY



BRUMME - OTIS

PER:
FOR:

GERA

MOBELLA

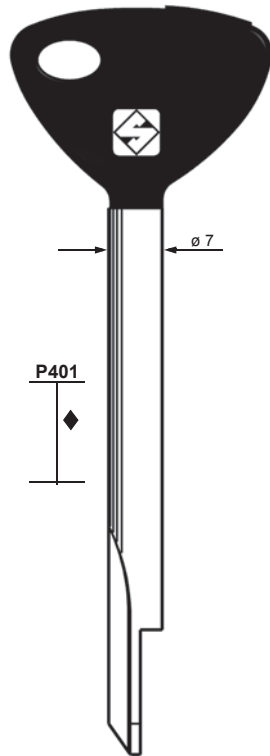

XG2P

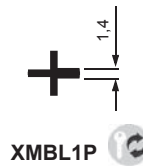



























































XMBL1P

Reinstated key
Chiave ripristinata
Wiedereingeführter Schlüssel
Clé restaurée
Llave restablecida
Chave restabelecida
Terug ingevoerde sleutel



General Index
Indice generale
Generalverzeichnis
Index général
Indice general
Índice geral
Algemene Index

Ref.	Page	Ref.	Page	Ref.	Page	Ref.	Page
AA3R 	3	BRT3 	5	CE17X32	6	CS62AP	7
AB58AP	3	BRT4 	5	CE17X33	6	CS70AP	7
AB88X	3	BSI2 	4	CE17X34	6	CU401 	8
AB89	3	BUR25	5	CE17X35	6	CU403 	8
AB95	3	BUR35	5	CE17X36	6	CU404 	8
AB98	3	BUR36	6	CE17X37	6	CU406 	8
AB100	3	BUR60R	6	CE17X38	6	CU407 	8
AB100R	3	BUR61R	6	CE17X39	6	CU408 	8
ACR2 	3	BUR62	6	CE17X40	6	CU409 	8
AGB4R 	3	CB103R	8	CE17X41	6	CU410 	8
AGE4R 	3	CB104R	8	CE17X42	6	CU411 	8
AGE6	3	CB105R	8	CE38W23	6	CU412 	8
AKR16R	3	CB106	8	CE38W24	6	DBX1R	9
ALP13R 	3	CE149	7	CE38W25	6	DM50R 	9
ALP15R 	3	CE150	7	CE38W26	6	DM60R 	9
AQ2 	4	CE17W23	6	CE38W27	6	DM94 	9
AQ2R 	4	CE17W24	6	CE38W28	6	DM80R 	9
ASS76 	4	CE17W25	6	CE38W29	6	DM123-5 	9
ASS187R	4	CE17W26	6	CE38W30	6	DM151R	9
AT2R 	4	CE17W27	6	CE38W31	6	DM152	9
AUD1 	4	CE17W28	6	CE38W32	6	DM153	9
AW22	4	CE17W29	6	CE38W33	6	DM154	9
AW23	4	CE17W30	6	CE38W34	6	DM154R	9
AZ2X	4	CE17W31	6	CE38W35	6	DM155	9
BAB13XL 	4	CE17W32	6	CE38W36	6	DX2R 	8
BAB26R-18	4	CE17W33	6	CE38W37	6	DX4R 	8
BES16	5	CE17W34	6	CE38W38	6	DX5R 	8
BES17	5	CE17W35	6	CE38W39	6	DX6R 	8
BK48R	5	CE17W36	6	CE38W40	6	DX7R 	8
BK49R	5	CE17W37	6	CE38W41	6	DX8R 	8
BK52	5	CE17W38	6	CE38W42	6	DX9R 	8
BK53	5	CE17W39	6	CIL4 	7	DX10R 	8
BK61	5	CE17W40	6	CLF1	6	DX11R 	8
BLG2	5	CE17W41	6	CLI1	7	DX12R 	8
BLL2 	4	CE17W42	6	CS116AP	7	DX13R 	8
BLL4 	4	CE17X23	6	CS139AP	7	DX14R 	8
BLL5 	4	CE17X24	6	CS154AP	7	DX15R 	8
BLV1R 	5	CE17X25	6	CS155AP	7	DX16R 	8
BLV2R 	5	CE17X26	6	CS156AP	7	DX17R 	8
BN1 	4	CE17X27	6	CS157AP	7	DX18R 	8
BN1R 	4	CE17X28	6	CS158AP	7	DX19R 	8
BRS1R	5	CE17X29	6	CS159AP	7	DX20R 	8
BRS2	5	CE17X30	6	CS162	7	DX21R 	8
BRT2 	5	CE17X31	6	CS163X	7	DX22R 	8



Ref.	Page	Ref.	Page	Ref.	Page	Ref.	Page
DX23R	8	GR9R-5	11	LOB13	14	OL6R	16
DX24R	8	GR9R-6	11	LOB7	14	PC3	16
DX25R	8	GVY2R	11	LOB8	14	PC5	16
DX26R	8	GYA8	23	LOB9R	14	PC7	16
DX27R	8	GYB8	23	LP37R	13	PC9	16
DX28R	8	GYC8	23	LP39	13	PC11R	16
EK2	9	GYD8	23	LP41	13	PC26	16
EK4	9	GYE8	23	LP42	13	PC27	16
EMK13	9	GYG8	23	LP43	13	PC28	16
EN2R	9	GYGB7	23	LP44	13	PC31R	16
ET2	9	GYH7	23	LP45	13	PC32R	17
EU20	9	GYH8	23	LP53	13	PC33	17
EU21P	10	GYK8	23	LT6R	13	PC33R	17
EV70	10	HD3	11	MG3R	14	PF21	17
EV70R	10	HE3	11	MH3	14	PHF26	17
EV109X	10	HG4	12	MH5	14	PHF26R	17
EV110RX	10	HG5	12	MI3R	15	PHF27	17
EV111RX	10	HG6	12	MI8	15	PHF27R	17
F2R	10	HGO2R	12	MIG1R	15	PHF28R	17
FAM2	10	HOK2R	11	MIG2R	15	PHF29	17
FB83R	10	HTE1	11	MIW4	15	PHF32	17
FF19	10	HW21R	12	MLM9	13	PN1R	17
FI1R	10	IBM1	12	MLM15	15	PT6RP	17
FI2	10	ICS3R	12	MN4	15	RA1R	17
FI6	10	IE5R	12	MO1RP	15	RBT1R	17
FIR2R	10	INS1R	12	MS24	14	RC8R	7
GD10	11	JW3R	12	MSL2	14	RC9R	7
GD10R	11	JW4	12	MSL3	14	RC10R	7
GE16	11	JW5R	12	NME3	15	REN5	17
GE17R	11	JW6R	12	OA3	16	RO84	17
GE18	11	JW7	12	OAL2	15	ROY1	18
GE23	11	JW9R	12	OAL2R	15	RU29R	18
GE23R	11	JW10	12	OAL3R	15	RU30	18
GE178RX-1	10	JW10R	12	OAL4R	15	RU4	18
GE178RX-2	10	JW13R	12	OC1R	16	SCM4	18
GE178RX-3	10	JW14	12	OC2R	16	SDT1R	19
GE178RX-4	10	KEY2	13	OJ17R	15	SFB1R	18
GE178RX-5	10	KG1	13	OL1	16	SIL1	18
GE178RX-6	10	KLE11	13	OL1R	16	SQ6R	18
GE178RX-7	10	LC9	13	OL2	16	STS12	18
GR15	11	LF4AP	14	OL2R	16	SV5	18
GR16	11	LH43R	13	OL3	16	SW1R	19
GR9R-2	11	LOB10R	14	OL3R	16	SW2	19
GR9R-4	11	LOB11R	14	OL4R	16	SWA9R	18

Ref.	Page	Ref.	Page	Ref.	Page	Ref.	Page
SWA13R	18	TO51RY18	20	VYA7	23	YYH7	23
TAR6	19	TO51Y12	20	VYA8	23	YYK7	23
TAR6R	19	TO51Y13	20	VYB7	23	YYP7R	23
TAR7	19	TO51Y15	20	VYB8	23	ZE39R	24
TAR7R	19	TO51Y16	20	VYC7	23	ZE46	24
TAR8R	19	TO51Y17	20	VYC8	23	ZE46R	24
TAR9	19	TO51Y4	20	VYD7	23	ZI2	24
TAR9R	19	TOZ6	19	VYD8	23	ZI3	24
TAR10	19	TOZ13	19	VYE7	23	ZO1	24
TAR10R	19	TOZ14	19	VYE8	23		
TAR11	19	TRK8DP	20	VYF7	23		
TAR11R	19	TRK9	20	VYF8	23		
TAR26	19	TRK9R	20	VYG7	23		
TL16R	21	TRK10	20	VYG8	23		
TO29X	20	TRK10R	20	VYH7	23		
TO50RX1	20	TRM3	3	VYH8	23		
TO50RX3	20	UL053XL	21	VYK7	23		
TO50RX8	20	UL064	21	VYK8	23		
TO50RX10	20	UL064L	21	WA8	22		
TO50RX11	20	UM1R	21	WE6	22		
TO50RX12	20	UNI37R	21	WE6R	22		
TO50RX13	20	UNI38R	21	WE12R	22		
TO50RX14	20	UNI40	21	WE13	22		
TO50RX15	20	UNI40R	21	WE13R	22		
TO50RX16	20	UNI41	21	WE14R	22		
TO50RX17	20	UNI44R	21	WE15	22		
TO50RX18	20	UNI46R	21	WK57	22		
TO50X9	20	UNI47R	21	WK62R	22		
TO50X12	20	UNI48	21	WK87X	23		
TO50X16	20	UNI48R	21	WMS3	23		
TO51RY2	20	UNI49	21	WS3	22		
TO51RY3	20	UNI49R	21	XG2P	24		
TO51RY5	20	UNI50R	21	XMBL1P	24		
TO51RY7	20	UNI52	21	YA33R	23		
TO51RY8	20	UNI52R	21	YA38	23		
TO51RY9	20	UNI56R	21	YA98R	23		
TO51RY10	20	UNI58R	21	YA99R	23		
TO51RY11	20	VAC152	21	YYA7	23		
TO51RY12	20	VAC153R	21	YYB7	23		
TO51RY13	20	VAV1	22	YYC7	23		
TO51RY14	20	VL1R	22	YYD7	23		
TO51RY15	20	VN1R	22	YYE7	23		
TO51RY16	20	VRF3	22	YYF7	23		
TO51RY17	20	VRF4	22	YYG7	23		



GB IMPORTANT

In compliance with current regulations relating to industrial property, we hereby state that the trade-marks or trade names mentioned in this document are the exclusive property of authorized manufacturers of locks and users.

Said trade-marks or trade names are nominated only for the purposes of information so that any lock for which our keys are made can be rapidly identified. This document is reserved exclusively for professional key cutters who use Silca products.

All information and illustrations in this document are for guidance only. Silca reserves the right to alter products designs, dimensions or info to improve the products quality.

The contents of this document are fully protected by Copyright and may not be copied or reproduced in any form, without written permission from Silca S.p.A. Any controversy shall be settled by the Courts of Justice where the company Silca S.p.A. has its headquarters, with express exclusion of any other court.

D WICHTIG

Gemäß den derzeit geltenden Normen bezüglich des Industrieigentums teilen wir Ihnen mit, dass die in der vorliegenden Dokumentation angeführten Markennamen oder Handelsmarken ausschließliches Eigentum der Schlosshersteller und zugelassenen Fachhändler sind.

Diese Markenbezeichnungen oder Handelsmarken sind nur zur Information angeführt, mit dem Zweck, schnell erkennen zu können, zu welchem Schloss unsere Schlüssel gehören. Die vorliegende Broschüre ist ausschließlich an Fachgeschäfte gerichtet, die Silca Produkte einsetzen.

Die Abbildungen und technischen Daten in dieser Broschüre sind nur zur Information. Silca behält sich vor, etwaige Änderungen, die zur Verbesserung des Produktes beitragen, vorzunehmen. Alle Zeichnungen und Fotos sind Eigentum der Firma Silca. Jede Reproduktion, auch teilweise, ist ohne ausdrückliche Genehmigung der Silca S.p.A. gesetzlich untersagt.

Im Falle von Streitfragen ist der Gerichtsstand des Firmensitzes Silca S.p.A. zuständig; jeder andere Gerichtsstand ist ausgeschlossen.

I IMPORTANTE

In conformità alle disposizioni legali in vigore relative alle proprietà industriali, informiamo che i marchi o le denominazioni commerciali citate nel nostro documento sono di proprietà esclusiva dei Fabbricanti di Serrature e degli utilizzatori autorizzati.

Questi marchi o denominazioni commerciali sono indicati a titolo di semplice informazione, con lo scopo di riconoscere velocemente a quali serrature le nostre chiavi sono destinate.

Questo documento è esclusivamente riservato ai professionisti della riproduzione chiavi che utilizzano i prodotti Silca.

Le illustrazioni e i dati tecnici dei prodotti contenuti nel documento debbono considerarsi indicativi. Silca si riserva il diritto, ferme restando le caratteristiche essenziali dei prodotti, di apportare tutte le modifiche che ritiene necessarie e opportune al fine di migliorare la qualità dei prodotti.

Tutti i disegni e le fotografie sono di proprietà di Silca, ogni riproduzione anche parziale, senza autorizzazione scritta di Silca S.p.A. è vietata secondo termini di legge. Per qualsiasi controversia competenti sono gli Uffici Giudiziari dove ha sede l'Azienda Silca S.p.A., con espressa esclusione di qualsiasi altro foro.

F IMPORTANT

Conformément aux lois en vigueur concernant la propriété industrielle, nous vous informons que les marques et appellations commerciales citées dans notre documentation appartiennent exclusivement aux fabricants de serrures et aux utilisateurs autorisés. Ces marques ou appellations commerciales sont indiquées à titre d'information pure et simple pour vous permettre de déterminer rapidement les serrures auxquelles nos clés sont destinées. Cette documentation est réservée exclusivement aux professionnels du taillage de clés qui utilisent les produits Silca.

Les illustrations et les caractéristiques techniques des produits présentés dans cette documentation sont données à titre indicatif. Bien que les caractéristiques essentielles des produits soient invariables, Silca se réserve le droit d'apporter toutes les modifications qu'elle retiendra nécessaires et opportunes afin d'améliorer la qualité de ses produits. Tous les dessins et photos sont propriété Silca et toute reproduction, même partielle, sans l'autorisation écrite préalable de Silca S.p.A. est interdite conformément aux prescriptions légales. Tout litige est du ressort exclusif des Tribunaux de la circonscription où se trouve le Siège de la Société Silca S.p.A.



E IMPORTANTE

En conformidad con las disposiciones legales vigentes sobre la Propiedad Industrial, las marcas y denominaciones comerciales citadas en nuestra documentación se declaran propiedad exclusiva de los fabricantes de cerraduras y los usuarios autorizados. Dichas marcas o denominaciones comerciales se citan con mero carácter informativo, con objeto de hacer comprender sin dificultad a qué cerraduras van destinadas nuestras llaves. Esta documentación está reservada exclusivamente a los profesionales de la duplicación de llaves que utilizan los productos Silca.

Las ilustraciones y los datos técnicos de los productos en esta documentación son indicativos. Silca se reserva el derecho, quedando invariables las características principales de los productos, de modificar todo lo que considere necesario y oportuno para mejorar la calidad de sus artículos. Todos los dibujos y fotografías pertenecen a Silca; según determina la Ley, se prohíbe toda reproducción, total o parcial, sin autorización por escrito de Silca S.p.A. En caso de disconformidad, la competencia es de las autoridades judiciales donde esté domiciliada la firma Silca S.p.A. excluyendo cualquier otro Tribunal.

P IMPORTANTE

Em conformidade com as disposições legais em vigor relativas à propriedade industrial, informamos que as marcas ou as denominações comerciais citadas no nossa documentação são propriedade exclusiva dos fabricantes de fechaduras e dos utilizadores autorizados. Estas marcas ou denominações comerciais são indicadas só a nível de informação, a fim de reconhecer rapidamente a quais fechaduras se destinam as nossas chaves. Esta documentação é reservada exclusivamente aos profissionais da reprodução de chaves que utilizam os produtos Silca.

As ilustrações e as características técnicas dos produtos apresentados neste catálogo são facultados a título indicativo. Mesmo que as características essenciais dos produtos sejam invariáveis, à Silca reserva-se o direito de modificar ser necessário e oportuno los productos, afim de melhorar a sua qualidade. Todos os desenhos e fotos são propriedade da Silca, e é proibida a sua reprodução mesmo parcial sem a autorização escrita da Silca S.p.A. conforme as prescrições legais. Em caso de litígio fica desde já designado, excluindo qualquer outro, o Tribunal da comarca onde está registrada a sede da Silca S.p.A.

NL BELANGRIJK

Graag vestigen wij de aandacht op het feit dat, in overeenstemming met de wettelijke beschikkingen die van kracht zijn inzake industriële eigendommen, de in dit document geciteerde merken en commerciële benamingen exclusieve eigendom zijn van de betreffende slotenfabrikanten en geautoriseerde gebruikers. Deze commerciële benamingen en merken worden zuiver informatief vermeld, met enkel als doel de sloten waarvoor onze sleutels geschikt zijn sneller te identificeren. Dit document is uitsluitend voorbehouden aan gespecialiseerde sleutelmakers die Silca producten gebruiken.

De illustraties en technische gegevens van de producten vermeld in dit document zijn louter illustratief en derhalve benaderend. Silca behoudt zich het recht voor om, mits behoud van de essentiële eigenschappen van haar producten, alle wijzigingen uit te voeren die zij nodig en opportuun acht ter verbetering van de productkwaliteit. Alle tekeningen en foto's zijn eigendom van Silca. Elke volledige of gedeeltelijke reproductie zonder schriftelijke toestemming van Silca S.p.A. is wettelijk verboden. Voor eventuele twisten is uitsluitend de Rechtbank van de plaats waar het bedrijf zijn zetel heeft bevoegd. Alle andere rechtbanken worden uitgesloten.

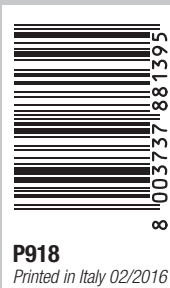

SILCA S.p.A.

Via Podgora, 20 (Z.I.)
31029 VITTORIO VENETO (TV)
Tel. +39 0438 9136
Fax +39 0438 913800
E-mail: silca@silca.it
www.silca.biz



SILCA GmbH
Siemensstrasse, 33
42551 VELBERT
Phone: +49 2051 2710
Fax +49 2051 271172
E-mail: info@silca.de
www.silca.de

SILCA KEY SYSTEMS S.A.
C/Santander 73A
08020 BARCELONA
Phone: +34 93 4981400
Fax +34 93 2788004
E-mail: silca@silca.es
www.silca.es

SILCA S.A.S.
12, Rue de Rouen
Z.I. Limay - Porcheville
78440 PORCHEVILLE
Phone: +33 1 30983500
Fax +33 1 30983501
E-mail: info@silca.fr
www.silca.fr

SILCA Ltd.
Unit 6 Lloyds Court
Manor Royal
CRAWLEY RH10 9QU
Phone: +44 1293 531134
Fax +44 1293 531108
E-mail: sales@silcaltd.co.uk
www.silcaltd.co.uk

FLEXONSILCA S.A.
Km 1.5 Via Briceño-Zipaguira
Parque Ind. Trafalgar Bodega 3
Tocancipa-Cundinamarca
Phone: +57 1 7366480
Fax +57 1 7366490
www.flexonsilca.co

H. CILLEKENS & B.V.
Metaalweg, 4
6045 JB ROERMOND
Phone: +31 475 325147
Fax +31 475 323640
E-mail: info@hcillekens.nl
www.hcillekens.nl

MINDA SILCA Engineering Ltd.
Plot no. 37- Toy City
Greater Noida-201308, U.P.
Phone: +91 9871397630/31
Fax +91 120 2351301
E-mail: info@mindsilca.in
www.mindsilca.in

KABA DO BRASIL Ltda
Rua Guilherme Asbahr Neto, 510
São Paul, SP 04646-001
Phone: +55 11 55454520 / 29
E-mail: silca@kabadobrasil.com.br
www.silcachaves.com.br

ADVANCED DIAGNOSTICS Ltd.
Eastboro Fields
Hemdale Business Park
Nuneaton CV11 6GL
United Kingdom
Phone: +44 24 7634 7000
www.advanced-diagnostics.com
www.adusa.us