



Look A-like Keys with GTI Transponder

Edition
JULY
2014



🇬🇧 SILCA LOOK A-LIKE KEYS RANGE

GTI is compatible with the new Silca Look A-like transponder keys series: a vehicle keys range with key head design identical to the original.

You will be able to easily recognize Silca Look A-like keys range thanks to the reference ending in TE (eg. F010TE).

- Key head design identical to the original.
- Wide and continuously updated keys range.

🇮🇹 GAMMA CHIAVI SILCA LOOK A-LIKE

GTI è compatibile con la nuova serie di chiavi transponder Silca Look A-like: una gamma di chiavi veicolo con design della testa identica alla chiave originale. Potrai riconoscere facilmente le chiavi della gamma Silca Look A-like per la referenza terminante in TE (es. F010TE).

- Design testa chiave identica all'originale.
- Gamma di referenze ampia e in continuo aggiornamento.

🇩🇪 SCHLÜSSEL SILCA LOOK A-LIKE

GTI kann mit den neuen Silca Look A-Like Transponder Schlüsseln verwendet werden: die Fahrzeugschlüssel mit Kopf-Design entsprechend dem Original-Schlüssel. Die Look A-like Schlüssel sind einfach erkennbar dank den Buchstaben "TE" am Ende der Artikelnummer (z.B. F010TE).

- Dem Original entsprechendes Schlüssel-Kopf-Design.
- Reichhaltig Schlüssel-Sortiment mit dauernder Erweiterung.

🇫🇷 GAMME CLÉS SILCA LOOK A-LIKE

GTI est compatible avec la nouvelle série de clés transpondeur Silca Look A-like: une gamme de clés pour véhicule avec un design de la tête identique à la clé originale. Vous pourrez reconnaître facilement les clés de la gamme Silca Look A-like par la référence, qui terminera avec TE (Ex: F010TE).

- Design tête clé identique à l'originale.
- Gamme de références ample et continuellement mise à jour.

🇪🇸 GAMA LLAVES SILCA LOOK A-LIKE

GTI es compatible con la nueva serie de llaves transponder Silca Look A-like: una gama llaves vehículo con el mismo design de la llave original. Podrá reconocer las llaves de la gama Silca Look A-like a través de la referencia que termina por TE (es. F010TE).

- Design de la cabeza llave idéntico al original.
- Gama referencias amplia y en continua evolución.

🇵🇹 LINHA DE CHAVES SILCA LOOK A-LIKE

O transponder GTI é compatível com a nova linha de chaves transponder Silca Look A-like: uma linha de chaves para veículos com o formato da cabeça igual às chaves originais. Você será capaz de reconhecer a linha de chaves Look A-like graças à referência que acaba sempre em TE (ex.: F010TE).

- Formato da cabeça da chave igual à chave original.
- Ampla linha de chaves, atualizada constantemente.

Transponder components / Componenti Transponder / Transponderkomponenten / Composants Transpondeur / Componentes Transponder / Componentes Transponder

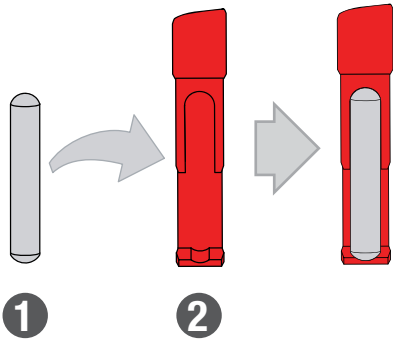

Code / Codice / Código: **C03313**

- | | |
|--|---|
| 1 GTI Transponder
Transponder GTI
Transponder GTI
Transpondeur GTI
Transponder GTI
Transponder GTI | 2 Transponder adapter
Adattatore transponder
Transponder adapter
Adaptateur pour transpondeur
Adaptador para transponder
Adaptador para transponder |
|--|---|

Transponder Key and GTI / Chiave Transponder e GTI / Transponderschlüssel und GTI / Clé Transpondeur et GTI / Llave Transponder y GTI / Chave Transponder e GTI

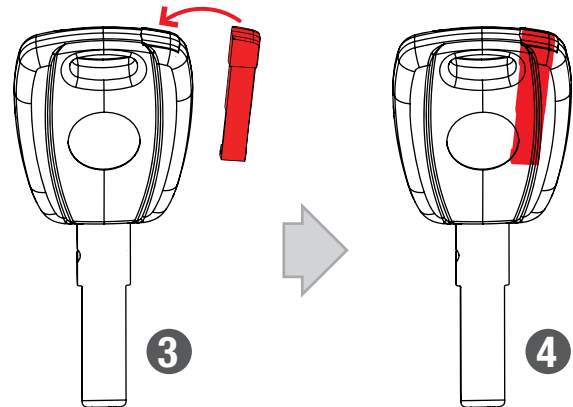

Code / Codice / Código: **SIP22TE**

- | | |
|--|--|
| 3 Transponder key without GTI
Chiave transponder senza GTI
Transponderschlüssel ohne GTI
Clé transpondeur sans GTI
Llave transponder sin GTI
Chave transponder sem GTI | 4 Transponder key with GTI inside
Chiave transponder con GTI inserito
Transponderschlüssel mit GTI eingefügt
Clé transpondeur avec GTI inséré
Llave transponder con GTI insertado
Chave transponder com GTI inserido |
|--|--|



Look A-like Keys with GTI Transponder

Edition
JULY
2014

BW9TE

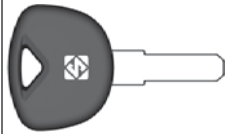

For/Per/Für/Pour/Por/Para:

BMW	→	→
C600 SPORT	2012	
C650 GT	2012	
F650	2008	2011
F800	2006	
G650	2011	
K1200	2005	2008
K1300	2009	
K1600	2011	
R1200	2005	

CY24TE

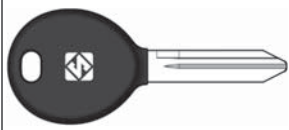

For/Per/Für/Pour/Por/Para:

CHRYSLER	→	→
200	2011	
300	1998	2004
300	2005	2008
ASPEN	2007	2009
CIRRUS	1999	2000
CIRRUS Convertible	2001	2002
CIRRUS SEDAN	2001	2002
CONCORDE	1998	2004
LHS	1999	2001
NEON	2000	2005
NEW YORKER	1998	2001
PACIFICA	2004	2008
PT CRUISER	2001	2005
PT CRUISER	2006	2011
PT CRUISER LE	2001	2005
SEBRING	2007	2011
SEBRING CONVERT	2001	2006
SEBRING CONVERT	2007	2011
SEBRING SEDAN	1999	2006
STRATUS	1998	2006
TOWN & COUNTRY	2001	2004
TOWN & COUNTRY	2004	2007
VISION	1998	
VOYAGER	1998	2003
VOYAGER	2004	2007

DODGE	→	→
AVENGER	2008	
CALIBER	2007	2012
CARAVAN	2001	2003
CARAVAN	2004	2007
CHARGER	2005	2008
DAKOTA	2001	2004
DAKOTA	2005	2011
DURANGO	2001	2004
DURANGO	2005	2009
INTREPID	1998	2004
INTREPID SEDAN, ES	2001	2004
MAGNUM	2005	2008
NEON	2000	2005
NITRO	2007	2012
RAM	2002	2005
RAM	2006	2011
STRATUS SEDAN	1998	2006

EAGLE	→	→
VISION	1998	

JEEP	→	→
CHEROKEE	1998	2004
CHEROKEE	2005	
CHEROKEE LIMITED	1999	2005
CJ5,CJ7	1998	2005
CJ5,CJ7	2006	
COMANCHE	2006	
COMMANDER	2006	2008
COMPASS	2007	
G. CHEROKEE	2005	2008
G. CHEROKEE LUX	1999	2005
G. CHEROKEE SPORT	1998	2004
LIBERTY	2002	2004
LIBERTY	2005	
PATRIOT	2007	
WRANGLER	1998	2006
WRANGLER	2006	

MITSUBISHI	→	→
RAIDER	2006	2010

JEEP	→	→
BREEZE	1999	2001
NEON	2000	2001
PROWLER	2000	2002

STERLING	→	→
BULLET		2008

DH5TE



For/Per/Für/Pour/Por/Para:

DAIHATSU	→	→
CUORE	1998	2006
MOVE	1997	2002

DWO4RTE

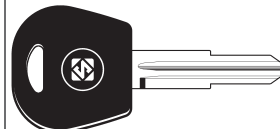

For/Per/Für/Pour/Por/Para:

CHEVROLET-DAEWOO	→	→
AVEO	2006	2011
AVEO	2006	2011
KALOS	2002	2006
LACETTI	2002	2004
LACETTI	2002	2004
LACETTI	2004	2009
NUBIRA	2000	2002
NUBIRA	2000	2002
NUBIRA SW	2004	2009
TACUMA	2000	2008

PONTIAC	→	→
G3	2010	

DWOSTE



For/Per/Für/Pour/Por/Para:

CHEVROLET-DAEWOO	→	→
CAPTIVA	2006	
EPICA	2006	
EPICA	2008	
EVANDA	2003	2006
LEGANZA	2000	2008

CHEVROLET USA	→	→
CAPTIVA SPORT	2012	

OPEL-VAUXHALL	→	→
ANTRA	2007	

SATURN (GM)	→	→
VUE	2008	2010

FO10TE

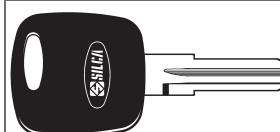

For/Per/Für/Pour/Por/Para:

FORD SUD-AMERICA	→	→
C-MAX	2004	2007
ECO-SPORT	2003	2007
FIESTA MAX	2005	
FIESTA	2003	

FO21TE



For/Per/Für/Pour/Por/Para:

FORD AUS	→	→
FALCON	1999	2006
TERRITORY	2004	2005

FORD EU	→	→
CONNECT	2002	
COUGAR	1997	2002
COURIER KOMBI	1998	2002
ESCORT	1995	2000
FIESTA	1995	2002

FO21TE

FORD EU	→	→
FIESTA	2003	2008
FOCUS	1998	2004
FUSION	2002	
KA	1996	2002
KA	2002	2008
MONDEO	1995	2001
MONDEO	2001	2007
PUMA	1998	2002
SCORPIO	1995	1998
TRANSIT	1995	2000
TRANSIT	2000	2006
TRANSIT	2007	
TRANSIT	2007	

FORD SUD-AMERICA	→	→
FOCUS	1998	2007
KA	2008	
MONDEO	2006	2007

FORD USA	→	→
TRANSIT CONNECT	2010	2012

JAGUAR	→	→
S-TYPE	2000	2008
XJ	2003	2007
X-TYPE	2002	2008

MAZDA	→	→
121	1997	2001

FO26TE

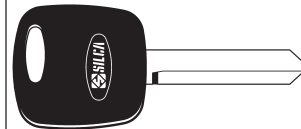

For/Per/Für/Pour/Por/Para:

FORD USA	→	→
CONTOUR V6 LX	1998	2000

MERCURY	→	→
COUGAR	1999	2002
MYSTIQUE V6 LS	1997	2002

FO38RTE

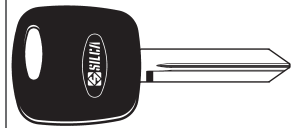

For/Per/Für/Pour/Por/Para:

FORD AUS	→	→
ESCAPE	2005	
EXPLORER SPORT TRAC	1998	2001
EXPLORER SPORT TRAC	2002	2005
EXPLORER	1996	2000
EXPLORER	2001	2003
EXPLORER	2004	
FOCUS	2000	2004
TAURUS LX / SHO	1998	1999
TRIBUTE	2001	2003

FORD SUD-AMERICA	→	→
RANGER	2004	

FORD USA

FORD USA	→	→
HEAVY TRUCKS	2000	2004
CROWN VICTORIA	1998	2002
CROWN VICTORIA	2003	2012
EDGE	2007	2010
EDGE	2007	2009
ESCAPE	2001	2004
ESCAPE	2005	2012
E-SERIES VAN	2008	2012
EXCURSION	2000	2006
EXPEDITION	1997	2002
EXPEDITION	2003	2010
EXPLORER SPORT TRAC	1999	2001
EXPLORER SPORT TRAC	2002	2010
EXPLORER	1998	2001
EXPLORER	2001	2003
EXPLORER	2004	2010
F-150	1998	2004
F-150	2004	2010
F-250	1998	2004
F-250	2004	2010
F-350	1999	2003
F-350	2004	2010
FIVE HUNDRED	2005	2007
FLEX	2009	2009
FLEX	2009	2010
FOCUS	2005	2007
FREESTAR	2004	2007
FREESTYLE	2005	2007
FREESTYLE	2005	2007
FUSION	2006	2011

FO38RTE

FORD USA	→	→
FUSION	2006	2009
MUSTANG COBRA	1996	1997
MUSTANG GT	1996	1997
MUSTANG	1998	2004
MUSTANG	2005	2012
RANGER XLT V6	1999	2000
RANGER	1999	2000
RANGER	2001	2010
TAURUS LX / SHO	1996	1999
TAURUS	2000	2003
TAURUS	2004	2007
TAURUS	2008	2011
TAURUS	2008	2009
THUNDERBIRD	2002	2005
WINDSTAR	1999	2000
WINDSTAR	2001	2003

LINCOLN

LINCOLN	→	→
AVIATOR	2003	2007
BLACKWOOD	2002	2003
CONTINENTAL	1998	2002
CONTINENTAL	2002	2004
LHS	1998	
LS	2000	2006
LS	2003	2006
MARK LT	2005	2009
MKX	2007	2010
MKZ	2006	2011
NAVIGATOR	1997	2002
NAVIGATOR	2002	2008
TOWN CAR	1998	2002
TOWN CAR	2003	
ZEPHYR	2006	

MERCURY

MERCURY	→	→
GRAND MARQUIS	1998	2002
GRAND MARQUIS	2003	2007
MARAUDER	2003	2005
MARINER	2005	2011
MILAN	2006	2011
MONTEGO	2005	2008
MONTEREY	2004	2007
MOUNTAINEER	1998	2001
MOUNTAINEER	2001	2011
SABLE GS, LS	2000	2007
SABLE GS	1999	2000
SABLE LS, SE, SHO	1996	2000

GT10BTE

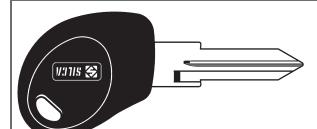

For/Per/Für/Pour/Por/Para:

CITROËN	→	→
JUMPER	1996	2001
RELAY	1996	2001

FIAT

FIAT	→	→
CINQUECENTO	1995	1996
CROMA	1995	1997
DUCATO	1996	2001
FIORINO	1995	2002
PANDA	1995	2002

IVECO

IVECO	→	→
35C11	2000	
EUROSTAR	1998	2002
NEW DAILY	1998	
S-2000	1998	

PEUGEOT

PEUGEOT	→	→
BOXER	1996	2001

GT15RBTE

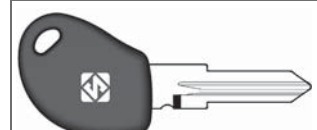

For/Per/Für/Pour/Por/Para:

FIAT	→	→
BRAVA	1995	1996
BRAVO	1995	1996
CINQUECENTO	1997	1998
MARENGO	1996	2001
SEICENTO	1997	2000
TEMPRA	1995	1996

HON66TE



For/Per/Für/Pour/Port/Para:

ACURA	→	→
CSX	2006	2011
MDX	2007	2013
RDX	2007	2012
TL	2007	
TSX	2007	
ZDX	2010	2012

HONDA	→	→
RD	2003	2006
ACCORD	2008	
CIVIC	2006	2014
CIVIC (Australia)	2003	
CR-V	2007	2014
CR-Z	2010	
INSIGHT	2009	
JAZZ	2009	
MDX (Australia)	2003	
STREAM	2008	

HONDA USA

HONDA USA	→	→
ACCORD	2003	
ACCORD CrossT	2010	
CIVIC	2006	
CR-V	2007	
CR-Z	2011	
ELEMENT	2006	2011
FIT	2009	
INSIGHT	2010	
ODYSSEY	2005	
PILOT	2006	
RIDGELINE	2005	

HON70TE

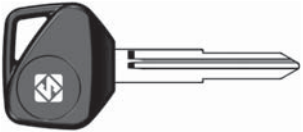

For/Per/Für/Pour/Port/Para:

HONDA	→	→
BLACK SPIRIT	2010	
CBF600	2007	
CBR600F	1999	2006
CBR600RR	2003	
CBR900	2003	
CBR1000	2004	
CBR1100XX	1999	2006
CROSSRUNNER	2011	
CROSSFOURER	2012	
CTX700	2014	
CTX1300	2014	
HORNET	2003	
INTEGRA	2012	
NC700 S	2012	
NC700 X	2012	
NC750	2014	
NT650V	1999	2006
NT700V	2006	2012
SHADOW 750	2004	
SILVER WING	2001	2008
ST1300 Pan-European	2008	
SW-T400	2009	
SW-T600	2011	
VARADERO	2003	
VFR800	2006	
VFR1200	2009	
VT1300CX	2009	
VT750 C4	2004	2010
VTX1800C	2002	
X-ELEVEN	2001	2003

HU43TE



For/Per/Für/Pour/Port/Para:

OPEL-VAUXHALL	→	→
SIGNUM	2003	2005
VECTRA	2002	2005

HU56RTE



For/Per/Für/Pour/Port/Para:

MITSUBISHI	→	→
COLT	2004	
SMART	→	→
FORFOUR	2004	2006

HU66TE

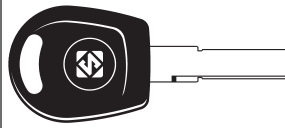

For/Per/Für/Pour/Port/Para:

AUDI	→	→
A8	2004	

PORSCHE	→	→
CAYMAN	2009	

HU83TE



For/Per/Für/Pour/Port/Para:

CITROËN	→	→
C4 PICASSO	2006	
C5	2008	
C8	2002	
DISPATCH	2007	
JUMPY	2007	

FIAT	→	→
SCUDO	2007	
ULYSSE	2002	2011

LANCIA	→	→
PHEDRA	2002	2011

PEUGEOT	→	→
207	2006	
208	2012	
307	2001	2009
308	2007	
807	2002	
2008	2013	
3008	2009	
5008	2009	
EXPERT	2007	
RCZ	2010	

HU87RTE

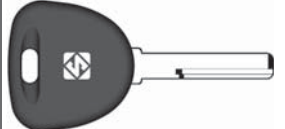

For/Per/Für/Pour/Port/Para:

SUBARU	→	→
G3X JUSTY	2004	2007

SUZUKI	→	→
IGNIS	2000	2005

HU92RTE



For/Per/Für/Pour/Port/Para:

BMW	→	→
SERIE 1	2004	2011
SERIE 3	2005	2011
SERIE 5	2003	2010
SERIE 6	2004	2011
SERIE 7	2002	2008
X5	2004	2011
Z4	2006	2011

HU92RTE

LAND ROVER	→	→
RANGE ROVER	2003	2005

HU100TE

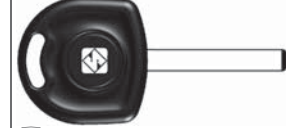

For/Per/Für/Pour/Port/Para:

BUICK	→	→
ALLURE	2010	
ENCORE	2014	
LACROSSE	2010	
REGAL	2011	
VERANO	2012	

CADILLAC

CADILLAC	→	→
SRX	2010	

CHEVROLET-DAEWOO

CHEVROLET-DAEWOO	→	→
AVEO	2011	
CRUZE	2009	
MALIBU	2012	
ORLANDO	2011	
TRAX	2013	
VOLT	2012	

CHEVROLET SUD-AMERICA

CHEVROLET SUD-AMERICA	→	→
AGILE	2009	

CHEVROLET USA

CHEVROLET USA	→	→
CAMARO	2010	
CRUZE	2011	
EQUINOX	2010	
MALIBU	2013	
ORLANDO	2012	
SONIC	2012	
VOLT	2011	

GMC (GM)

GMC (GM)	→	→
SIERRA	2014	
TERRAIN	2010	

HOLDEN

HOLDEN	→	→
ASTRA	2004	
VECTRA	2004	
ZAFIRA	2004	

OPEL-VAUXHALL

OPEL-VAUXHALL	→	→
ADAM	2013	
AMPERA	2012	
ASTRA	2004	
CABRIO	2013	
CASCADA	2013	
CORSA	2006	
INSIGNIA	2008	
MERIVA	2010	
MOKKA	2012	
SIGNUM	2003	2008
VECTRA	2004	2008
ZAFIRA	2006	

SATURN (GM)

SATURN (GM)	→	→
ASTRA	2008	2009

HU101TE

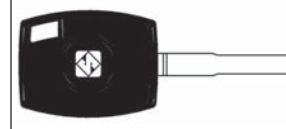

For/Per/Für/Pour/Port/Para:

FORD AUS	→	→
BF FALCON	2005	
TERRITORY	2005	

FORD EU

FORD EU	→	→
FIESTA	2008	2012
FOCUS	2004	2010
FOCUS C-MAX	2003	2010
GALAXY	2006	2010
KUGA	2008	
MONDEO	2007	2010
S-MAX	2006	2010

FORD SUD-AMERICA

FORD SUD-AMERICA	→	→
MONDEO	2007	

LAND ROVER

LAND ROVER	→	→
DISCOVERY 3	2006	2009
RANGE ROVER SPORT	2006	2009

HU133RTE



For/Per/Für/Pour/Port/Para:

FIAT	→	→
SEDICI	2006	

MARUTI SUZUKI

MARUTI SUZUKI	→	→
ALTO K10	2010	
A-STAR	2007	
RITZ	2007	
SWIFT	2007	
SX4	2007	
WAGON R	2010	
PIXO	2009	

OPEL-VAUXHALL

OPEL-VAUXHALL	→	→
AGILA	2008	

SUZUKI

SUZUKI	→	→
ALTO	2009	
GRAND VITARA	2008	
IGNIS	2003	2008
JIMNY	2002	
SPLASH	2008	
SWIFT	2005	
SX4	2006	

HYN6TE

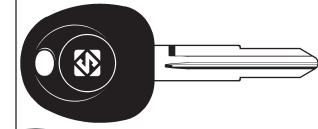

For/Per/Für/Pour/Port/Para:

HYUNDAI	→	→
ACCENT	1999	2011
COUPE	1996	2001
COUPE	2001	2009
ELANTRA	2000	2006
EXCEL	1999	
GALLOPER	1999	2003
GETZ	2002	2009
H-1	1999	2006
H-1	2006	
INNOVATION	1999	2003
LANTRA	1996	2000
LAVITA	2001	2010
MATRIX	2002	2010
SANTAFE	2002	2006
SANTAMO	2000	2003
SCOUPE	1996	
TERRACAN	2001	2007
TIBURON	2001	2008
TUCSON	2005	2009
VERNA	1999	

KIA

KIA	→	→
MORNING	2006	
PICANTO	2004	2008
SPORTAGE	2006	

HYN7RTE

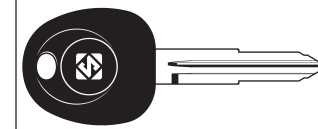

For/Per/Für/Pour/Port/Para:

HYUNDAI	→	→
GRANDEUR XG (AUS)	1998	2005
SANTAFE	2000	2002
SONATA	1996	1998
SONATA	1998	2004
SONICA	1996	1998
SONICA	1999	2004
TRAJET	2000	2006
XG25/XG30	1998	2005
XG300 (CANADA)	1998	2005

KIA

KIA	→	→
SORENTO	2002	2009



Look A-like Keys with GTI Transponder

Edition
JULY
2014

HYN10TE

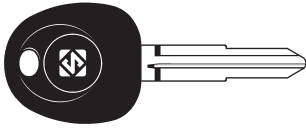

For/Per/Für/Pour/Por/Para:

HYUNDAI		
ACCENT	1996	1999
ATOS	1997	2000
ATOS PRIME	1999	2001
ATOS PRIME	2002	2008
EXCEL	1996	1999
PONY	1995	1999
VERNA	1996	1999

HYN12TE



For/Per/Für/Pour/Por/Para:

HYUNDAI		
STAREX	1998	2006

HYN14TE

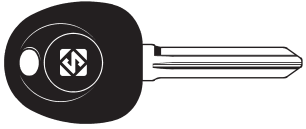

For/Per/Für/Pour/Por/Para:

HYUNDAI		
ENTOURAGE	2007	2009
I10	2008	
H-1 BUS	2007	

KIA		
CARENS	2006	
CARNIVAL	2006	
OPTIMA	2006	
SEDONA	2006	

HYN14RTE

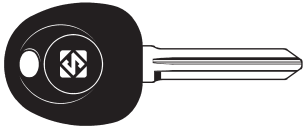

For/Per/Für/Pour/Por/Para:

HYUNDAI		
ELANTRA	2007	
GENESIS C.PE	2010	
iLOAD	2008	
iMAX	2008	
SANTAFE	2006	
SONATA	2005	
VERACRUZ	2007	2012

HYN15TE

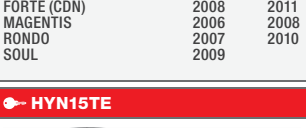

For/Per/Für/Pour/Por/Para:

KIA		
FORTE (CDN)	2008	2011
MAGENTIS	2006	2008
RONDO	2007	2010
SOUL	2009	

HYN17BTE

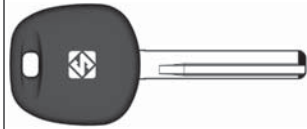

For/Per/Für/Pour/Por/Para:

HYUNDAI		
ACCENT (AUS)	2012	
VELOSTER (AUS)	2012	

HYN17RBTE

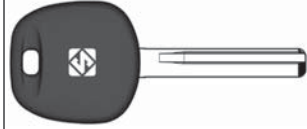

For/Per/Für/Pour/Por/Para:

HYUNDAI		
SANTA FE (AUS)	2013	

KIA3RTE

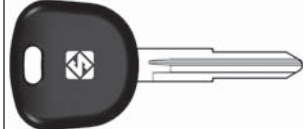

For/Per/Für/Pour/Por/Para:

KIA		
CARENS	2001	2006
CARENS	2001	2006
CARNIVAL	2002	2005
CLARUS	1998	2001
JOICE	2000	2003
MAGENTIS	2001	2006
MENTOR	2002	2004
OPTIMA	2001	2006
RIO	2001	2005
RONDO	2001	2006
SEDONA	2002	2005
SEPHIA	2002	2004
SHUMA	1998	2001
SPORTAGE	1998	1999
SPORTAGE	2001	2003

KW16TE

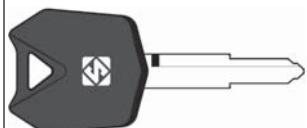

For/Per/Für/Pour/Por/Para:

KAWASAKI		
NINJA ZX-6R	2006	
NINJA ZX-10R	2004	2010
NINJA ZX-12R	2002	2006
NINJA ZX-14R	2006	2011
Z1000	2004	2009
Z750S	2006	
ZZR1200	2002	2006
ZZR1400	2007	2011

MAZ24RTE

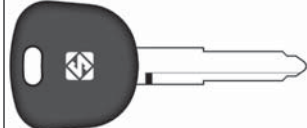

For/Per/Für/Pour/Por/Para:

MAZDA		
CX-7	2007	
CX-9	2007	
DEMIO [J]	2003	
MAZDA 2	2003	
MAZDA 3	2004	2013
MAZDA 5	2005	
MAZDA 6	2003	2012
MX-5	2005	
RX-8	2004	2012

MIT8TE

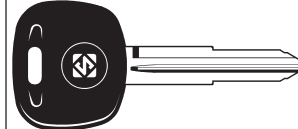

For/Per/Für/Pour/Por/Para:

MITSUBISHI		
CHALLENGER	1999	2002
CHALLENGER	2002	2003
DIAMANTE	2002	2006
ECLIPSE	1996	2000
ECLIPSE	2001	2005
EXPRESS	1996	
FOCUS	1998	
GALANT	1996	2000
GALANT	2002	2005
L200	2002	2006
L200	2006	
MONTERO	1996	2000
MONTERO	2001	2006
MONTERO	2002	2005
MONTERO	2002	2003
MONTERO SPORT	2000	2002
MONTERO SPORT	2001	2004
MONTERO SPORT	2002	2005
NIMBUS	1998	1999
OUTLANDER	2000	2003
PAJERO SPORT	1999	2002
PAJERO SPORT	2002	2003
PAJERO SPORT	2002	2006
PAJERO	1996	2000
PAJERO	2000	2002
PAJERO	2002	2003
PAJERO	2002	2005
PAJERO	2006	
SHOGUN SPORT	1999	2002
SHOGUN SPORT	2002	2003
SHOGUN	1996	2000
SHOGUN	2000	2002
SHOGUN	2002	2003
SHOGUN	2002	2005
SPACE GEAR	1996	
SPACE RUNNER	1998	1999
SPACE WAGON	1998	1999
SPACE WAGON	1999	2003
VERADA	2002	2003

MIT11RTE

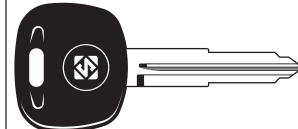

For/Per/Für/Pour/Por/Para:

CITROËN		
C-CROSSER	2007	
C-ZERO	2011	

MITSUBISHI

MITSUBISHI		
380	2006	
COLT	1996	2000
ECLIPSE	2008	2012
ENDEAVOR	2007	2011
GALANT (USA)	2008	2012
GALANT	2006	
GRANDIS	2003	
I-MIEV	2010	
LANCER SW	1996	2003
LANCER	1996	2003
LANCER	2003	2006
LANCER	2006	
MIRAGE	1996	2002
MIRAGE	2014	
MONTERO IO	2000	2006
OUTLANDER	2004	2006
OUTLANDER	2006	
PAJERO IO	1999	2004
PAJERO MINI [J]	1999	
PAJERO PININ	1999	2004
PAJERO PININ	1999	2004
SHOGUN PININ	1999	2004

PEUGEOT

PEUGEOT		
4007	2007	
ION	2011	

NE72ATE

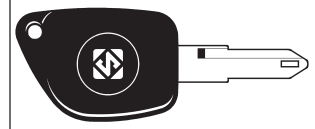

For/Per/Für/Pour/Por/Para:

NISSAN		
INTERSTAR	2002	2010
PRIMASTAR	2003	

OPEL-VAUXHALL

OPEL-VAUXHALL		
MOVANO	2002	2010
VIVARO	2002	

RENAULT

RENAULT		
CLIO II	2001	2012
MASTER	2002	2010
THALIA	2001	2008
TRAFIC	2002	

RENAULT-DACIA

RENAULT-DACIA		
SYMBOL	2010	
SYMBOL	2010	2013

NE73TE

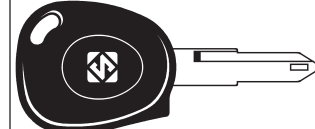

For/Per/Für/Pour/Por/Para:

NISSAN		
INTERSTAR	2002	2010

OPEL-VAUXHALL

OPEL-VAUXHALL		
MOVANO	2002	2010

PEUGEOT

PEUGEOT		
106	2000	2004
206	2001	2009
206 Cabrio	2002	2007
206 PLUS	2009	

RENAULT

RENAULT		
AVANTIME	2001	2003
MASTER	2002	2010
MEGANE	1998	2000
MEGANE	2000	2003

NSN11TE

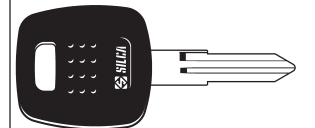

For/Per/Für/Pour/Por/Para:

NISSAN		
ATLEON	2002	
CAB STAR	2000	2003
CAB STAR	2003	2007
MICRA MARCH [J]	2000	2003
MICRA VAN	2000	2003
MICRA	2000	2003
TERRANO II	2002	2006
VANETTE CARGO	2000	
VANETTE	2000	

NSN14TE



For/Per/Für/Pour/Por/Para:

INFINITI		
FX35	2003	2009
FX45	2003	2009
G20	2000	2002
G35	2003	2007
I30	2001	2004
I35	2001	2004
M35	2003	2004
M45	2003	2006
Q45	1997	2000
Q45	2001	2005



Look A-like Keys with GTI Transponder

Edition
JULY
2014

NSN14TE

INFINITI		
QX4	1997	1999
QX4	1999	2003
QX56	2004	2007
NISSAN		
ALMERA TINO	2000	2003
ALMERA TINO	2004	2006
ALMERA	2000	2003
ALMERA	2003	2006
JUKE	2010	
MICRA	2003	
MURANO	2003	2007
NAVARA	2003	2005
NAVARA	2003	2005
NAVARA	2005	2012
NOTE	2010	
NP300	2010	
PATHFINDER	2005	
PATROL	2004	
PRIMERA	1998	2000
PRIMERA	2002	2008
PULSAR	1998	2000
QASHQAI	2007	2013
XTERRA	2000	2004
X-TRAIL	2001	2003
X-TRAIL	2004	
NISSAN USA		
350Z	2003	2009
ALTIMA	2005	2006
ARMADA	2004	
CUBE	2009	2013
FRONTIER	2002	2005
FRONTIER	2005	
JUKE	2011	
LIVINA	2007	
MAXIMA	2000	2003
MAXIMA	2004	2007
MURANO	2003	2008
NV Series	2012	
PATHFINDER	2005	
QUEST	2004	2010
ROGUE	2007	
SENTRA	2007	
TIIDA	2007	
TITAN	2004	
VERSA	2007	
XTERRA	2005	2013
X-TRAIL	2005	2006
SUBARU		
FORESTER	1998	2003
IMPREZA	1998	2003
LEGACY	1998	2003
OUTBACK	1998	2003
SUZUKI		
EQUATOR	2009	

NSN19TE

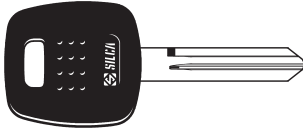
		
For/Per/Für/Pour/Por/Para:		
NISSAN		
CAB STAR	2007	
RENAULT		
MAXITY	2007	
SUBARU		
B9 TRIBECA	2006	2011
BAJA	2005	2007
FORESTER (AUS)	1998	2004
FORESTER	2004	2007
IMPREZA (AUS)	1998	2004
IMPREZA	2004	2007
LIBERTY (AUS)	1998	2003
OUTBACK (AUS)	1998	2003

SIP16TE

		
For/Per/Für/Pour/Por/Para:		
ALFA ROMEO		
166	2000	2004

SIP22TE

		
For/Per/Für/Pour/Por/Para:		
ABARTH		
GRANDE PUNTO	2007	2010
PUNTO	2012	
PUNTO EVO	2010	2012
500	2008	
ALFA ROMEO		
GIULIETTA	2010	
MiTo	2008	
156	2001	2003
156 SPORT WAGON	2001	2007
166	2004	2008
CITROËN		
JUMPER	2006	
NEMO	2008	
RELAY	2006	
FIAT		
BRAVO	2007	
DOBLO'	2006	
DUCATO	2006	
FIORINO	2007	
GRANDE PUNTO	2005	
IDEA	2009	
PANDA	2002	
PUNTO	2012	
PUNTO EVO	2009	2012
QUBO	2008	
500	2007	
500L	2012	
FORD EU		
KA	2009	
IVECO		
EUROCARGO	2002	2007
STRALIS	2002	2007
LANCIA		
DELTA	2008	
MUSA	2009	
YPSILON	2011	
PEUGEOT		
BIPPER	2009	
BOXER	2006	

SSY3TE

		
For/Per/Für/Pour/Por/Para:		
NISSAN		
CAB STAR	2007	
RENAULT		
MAXITY	2007	
SUBARU		
B9 TRIBECA	2006	2011
BAJA	2005	2007
FORESTER (AUS)	1998	2004
FORESTER	2004	2007
IMPREZA (AUS)	1998	2004
IMPREZA	2004	2007
LIBERTY (AUS)	1998	2003
OUTBACK (AUS)	1998	2003

SX9TE

		
For/Per/Für/Pour/Por/Para:		
CITROËN		
BERLINGO	2001	2002
C5	2000	2004
DISPATCH	2002	2006
JUMPY	2002	2006
SAXO	2000	2003
XSARA	2001	2006
XSARA PICASSO	2000	2006
FIAT		
SCUDO	2002	2006
PEUGEOT		
EXPERT	2002	2006
PARTNER	2001	2002
RANCH	2001	2002

SZ11TE

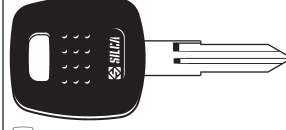
		
For/Per/Für/Pour/Por/Para:		
MARUTI SUZUKI		
ALTO	2007	2010
SUZUKI		
ALTO	2002	2008

SZ11RTE

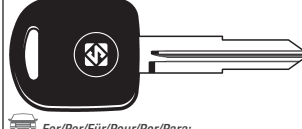
		
For/Per/Für/Pour/Por/Para:		
MARUTI SUZUKI		
VERSA	2007	2010
WAGON R	2007	2010
ZEN ESTILO	2007	2010
SUZUKI		
ALTO	1996	2002
ALTO	2002	2008
BALENO	1996	2001
ESCUDO [J]	1996	2002
GRAND VITARA	1996	2002
GRAND VITARA	2002	2008
IGNIS	2000	2008
JIMNY	1999	2002
JIMNY	2002	
SWIFT	1996	2005
VITARA	1996	2002
VITARA	2002	2008
WAGON R	1998	2000

SZ12TE

		
For/Per/Für/Pour/Por/Para:		
ISUZU		
BIG HORN	1998	2002
TROOPER	1998	2002
SUBARU		
JUSTY	1996	2003
SUZUKI		
ALTO	1996	2002
BALENO	1996	2001
ESCUDO [J]	1996	2002
GRAND VITARA	1996	2002
SWIFT	1996	2005
VITARA	1996	2002

SZ17RTE

		
For/Per/Für/Pour/Para:		
SUZUKI		
GSF BANDIT	2007	
GSR600	2007	
GSX1300 HAYABUSA	2007	
GSX-R1000	2006	
GSX-R600	2006	
GSX-R750	2006	
V-STROM	2007	

TOY40BTE

		
For/Per/Für/Pour/Por/Para:		
LEXUS		
CELSIOR [J]	1997	
ES300	1998	2001
LAND CRUISER [J]	1999	
LS400	1997	2000
LX450	1998	
LX470	1999	2000
SC300/400	1998	2003
MITSUBISHI		
MAGNA	1999	2005
VERADA (AUS)	2000	2002
TOYOTA		
LAND CRUISER	1998	2000
CELSIOR	1998	2004
TOYOTA JAPAN		
CELSIOR	1998	2004

TOY41RATE

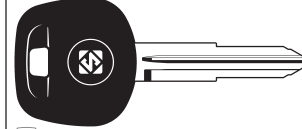
		
For/Per/Für/Pour/Por/Para:		
TOYOTA JAPAN		
PLATZ	1999	2002
TOYOTA		
ECHO	1999	2005

TOY41RTE

		
For/Per/Für/Pour/Por/Para:		
DAIHATSU		
CHARADE	1998	2004
COPEN	2002	
CUORE	1998	2006
CUORE	2007	
FEROZA	1995	1998
MATERIA	2006	
SIRION	1998	2004
SIRION	2005	
TERIOS	1997	2005
TERIOS	2006	
TREVIS	2007	
YRV	2000	2005
TOYOTA		
MR2	1997	2007
YARIS	1999	2005
TOYOTA USA		
MR2	2001	2005

TOY43ATE

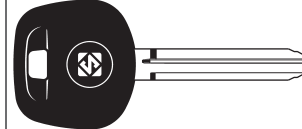
		
For/Per/Für/Pour/Por/Para:		
PONTIAC		
VIBE	2009	2010
SCION		
TC	2005	2010
XA	2004	2007
XB	2004	2008
XD	2008	2012



Look A-like Keys with GTI Transponder

Edition
JULY
2014

TOY43ATE

TOYOTA	↳	→
4RUNNER	1999	2002
ALPHARD	2005	
AURION (AUS)	2006	
AURIS	2006	
AVENSIS VERSO	2001	2003
CAMRY	1996	2005
CAMRY	2006	
CELICA	2000	2005
COROLLA	2007	
ECHO VERSO	2002	2005
FJ CRUISER	2007	
FORTUNER	2007	
HIACE	1995	2006
HIACE	2007	
HILUX	1999	2004
HILUX	2005	
INNOVA KIJANG	2005	
iQ	2008	
LAND CRUISER 90	1996	2002
LAND CRUISER 100	1998	2002
LAND CRUISER 100	2003	
LAND CRUISER 120	2002	
LAND CRUISER PRADO	2002	
PICNIC	1996	2003
PICNIC	2003	2008
PREVIA	2000	2003
PREVIA	2003	2008
PRIUS	2000	2003
RAV 4	2005	2010
REIZ	2005	
T.U.V.	2003	
TARAGO	2003	2008
VIOS	2007	
WISH	2004	

TOYOTA JAPAN	↳	→
ALPHARD	2003	
bB	2000	2005
CALDINA	2002	2004
COROLLA FIELDER	2004	
COROLLA RUNX	2004	
COROLLA SPACIO	2003	
DYNA	2008	
ESTIMA	2001	2003
ESTIMA	2003	
FUN CARGO	2003	2005
GAIA	1999	2004
IPSUM	1996	2003
IPSUM	2003	
ISIS	2003	
IST	2003	
KLUGER	2001	2003
KLUGER	2003	
LAND CRUISER PRADO	2000	2002
LAND CRUISER PRADO	2002	2005
MARK 2	2000	2006
MARK X	2004	
NOAH	2004	
OPEN DECK	2000	2005
PLATZ	2003	2005
PRONARD	2000	2002
RAUM	2003	
RAV 4	2003	
REGIUSACE	2007	
SIENTA	2003	
TOYOACE	2008	
VANGUARD	2005	
VEROSSA	2001	2004
VITZ	2003	
VOXY	2004	
WISH	2003	

TOYOTA USA	↳	→
4RUNNER	1999	2002
4RUNNER	2003	2010
AVALON	1998	2004
AVALON	2005	2011
AVANZA	2004	
CAMRY	1998	2004
CAMRY	2003	2010
COROLLA	2005	2010
FJ CRUISER	2007	2010
HIACE	2006	
HIGHLANDER	2001	2003
HIGHLANDER	2004	2010
LAND CRUISER	1998	2002
LAND CRUISER	2003	2008
MATRIX	2005	2010
PRIUS	2001	2003
PRIUS	2004	2008
RAV 4	2006	2010

TOY43ATE

TOYOTA USA	↳	→
SEQUOIA	2001	2002
SEQUOIA	2003	2010
SIENNA	1999	2003
SIENNA	2004	2010
SOLARA	2002	2003
SOLARA	2004	2010
TACOMA	2005	2010
TUNDRA	2005	2010
VENZA	2009	2010
YARIS	2007	2011

TOY43TE

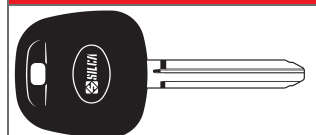

For/Per/Für/Pour/Para:

TOYOTA	↳	→
COROLLA	1996	2006
RAV 4	1996	2004

TOY46RTE

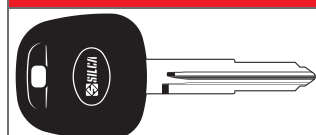

For/Per/Für/Pour/Para:

TOYOTA	↳	→
COROLLA	1996	1999

TOY47TE



For/Per/Für/Pour/Para:

DAIHATSU	↳	→
CHARADE	2011	

TOYOTA	↳	→
AURIS (EU)	2007	
AVENSIS	1998	2000
AVENSIS	2000	2003
AVENSIS	2003	
CARINA	1996	2000
COROLLA (S. Africa)	2008	
COROLLA	1999	2006
YARIS	1999	2005
YARIS	2005	2011

TOY48BTE



For/Per/Für/Pour/Para:

LEXUS	↳	→
ALTEZZA [J]	1999	
ES300	2002	2003
ES330	2004	2007

TOY48BTE

LEXUS	↳	→
GS/LS/LX	1998	
GS300	1998	2005
GS300	2005	2007
GS300/400 [J]	1998	
GS400	1998	2001
GS430	2001	2005
GS430	2005	2007
GX470	2003	2007
IS200	1999	2005
IS300	2001	2005
LS200	1999	
LS400	1999	2003
LS430	2001	2006
LX470	2001	2002
LX470	2003	2008
RX300	1999	2003
RX330	2004	2009
RX350	2004	2011
RX400h	2005	2009
RX450h	2010	
SC430	2002	2010

TOYOTA	↳	→
LAND CRUISER 100	2000	2002
LAND CRUISER 100 (AUS)	2003	

TOYOTA JAPAN

TOYOTA JAPAN	↳	→
ARISTO	1998	2005
BREVIS	2001	2007
CELSIOR	1998	2004
CROWN	1999	2005
LAND CRUISER PRADO	2000	2002
ORIGIN	2000	
PROGRES NC300	1998	2006
WINDOM	2001	2004

TOY49TE



For/Per/Für/Pour/Para:

HYUNDAI	↳	→
i20	2008	
i30	2007	2011
i40 (AUS)	2010	
i45	2009	
iX20	2010	
iX35	2010	

KIA	↳	→
BORREGO	2009	2011
MAGENTIS	2009	2011
OPIRUS	2007	2010
RIO	2010	2011

VA2TE



For/Per/Für/Pour/Para:

SMART	↳	→
FORTWO	2009	

VAC102TE



For/Per/Für/Pour/Para:

RENAULT	↳	→
KANGOO	2002	2010
TWINGO	2002	2007

RENAULT-DACIA	↳	→
DUSTER	2010	2013
LOGAN	2006	2012
SANDERO	2008	2013

VH35RATE

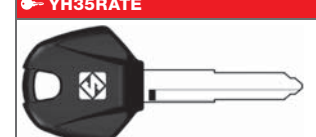

For/Per/Für/Pour/Para:

YAMAHA	↳	→
BT1100 BullDog	2005	
FJR1300	2005	
FZ1	2006	

YAMAHA

YAMAHA	↳	→
FZ6	2004	2011
FZ8	2010	
FZS1000 FAZER	2005	
Majesty 400	2005	
MT-01	2005	2012
MT-03	2006	
TDM600	2005	
T-MAX 500	2005	2012
XJR 1300	2004	
XT660Z Ténéré	2008	
XT1200Z Super Ténéré	2010	
XTR	2004	
XTX	2004	
XVS650A DragStar	2004	2006
XVS1100A DragStar	2004	
YZF-R1	2005	
YZF-R6	2003	

ZD24RTE

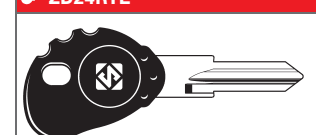

For/Per/Für/Pour/Para:

HONDA	↳	→
SH300	2007	

TRIUMPH	↳	→
TIGER	2010	

YAMAHA	↳	→
X-MAX 125	2006	

↳ In production from year... / Fabricata dall'anno... / Hergestellt seit Jahr... / Fabriqué à partir de l'année... / Fabricada desde el año... / Em produção do ano...
 → In production until year... / Fabricata fino all'anno... / Hergestellt bis Jahr... / Fabriqué jusqu'à l'année... / Fabricada hasta el año... / Em produção até ano...



Look A-like Keys with GTI Transponder

Edition
JULY
2014

EN IMPORTANT

In compliance with current regulations relating to industrial property, we hereby state that the trade-marks or trade names mentioned in our catalogue are the exclusive property of authorized manufacturers of locks and users. Said trade-marks or trade names are nominated only for the purposes of information so that any lock for which our keys are made can be rapidly identified. This catalogue is reserved exclusively for professional key cutters who use Silca products.

All information and illustrations in this catalogue are for guidance only. Silca reserves the right to alter products designs, dimensions or info to improve the products quality. The contents of this catalogue are fully protected by Copyright and may not be copied or reproduced in any form, without written permission from Silca. Any infringements will be dealt with under Italian law.

IT IMPORTANTE

In conformità alle disposizioni legali in vigore relative alle proprietà industriali, informiamo che i marchi o le denominazioni commerciali citate nel nostro catalogo sono di proprietà esclusiva dei fabbricanti di serrature e degli utilizzatori autorizzati. Questi marchi o denominazioni commerciali sono indicati a titolo di semplice informazione, con lo scopo di riconoscere velocemente a quali serrature le nostre chiavi sono destinate. Questo catalogo è esclusivamente riservato ai professionisti della riproduzione chiavi che utilizzano i prodotti Silca.

Le illustrazioni e i dati tecnici dei prodotti contenuti nel catalogo debbono considerarsi indicativi. Silca si riserva il diritto, ferme restando le caratteristiche essenziali dei prodotti, di apportare tutte le modifiche che ritiene necessarie e opportune al fine di migliorare la qualità dei prodotti. Tutti i disegni e le fotografie sono di proprietà di Silca, ogni riproduzione anche parziale, senza autorizzazione scritta della Silca è vietata secondo termini di legge. Per qualsiasi controversia competenti sono gli Uffici Giudiziari dove ha sede l'Azienda, con espressa esclusione di qualsiasi altro foro.

DE WICHTIG

Gemäß den derzeit geltenden Normen bezüglich des Industrieigentums teilen wir Ihnen mit, daß die im vorliegenden Katalog angeführten Markennamen oder Handelsmarken ausschließliches Eigentum der Schloßhersteller und zugelassenen Fachhändler sind. Diese Markenbezeichnungen oder Handelsmarken sind nur zur Information angeführt, mit dem Zweck, schnell erkennen zu können, zu welchem Schloß unsere Schlüssel gehören. Der vorliegende Katalog ist ausschließlich an Schlüsselkopier-Fachgeschäfte, die Silca Produkte benutzen, gerichtet.

Die Abbildungen und technischen Daten des Katalogs sind nur zur Information. Silca behält sich vor, etwaige Änderungen am Produkt, die zur Verbesserung desselben beitragen vorzunehmen. Alle Zeichnungen und Fotos sind Besitz der Firma Silca, jede Reproduktion, auch teilweise, ist ohne schriftliche Erlaubnis der Firma Silca gesetzlich untersagt. Im Falle von Streitfragen ist der Gerichtshof des Firmensitzes zuständig; jeder andere Gerichtshof ist ausgeschlossen.

FR IMPORTANT

Conformément aux lois en vigueur concernant la propriété industrielle, nous vous informons que les marques et appellations commerciales citées dans notre catalogue appartiennent exclusivement aux fabricants de serrures et aux utilisateurs autorisés. Ces marques ou appellations commerciales sont indiquées à titre d'information pure et simple pour vous permettre de déterminer rapidement les serrures auxquelles nos clés sont destinées. Ce catalogue est réservé exclusivement aux professionnels du taillage de clés qui utilisent les produits Silca.

Les illustrations et les caractéristiques techniques des produits présentés dans ce catalogue sont données à titre indicatif. Bien que les caractéristiques essentielles des produits soient invariables, Silca se réserve le droit d'apporter toutes les modifications qu'elle retiendra nécessaires et opportunes afin d'améliorer la qualité de ses produits. Tous les dessins et photos sont propriété Silca et toute reproduction, même partielle, sans l'autorisation écrite préalable de Silca est interdite conformément aux prescriptions légales. Tout litige est du ressort exclusif des Tribunaux de la circonscription où se trouve le Siège de la Société.

ES IMPORTANTE

Conformément aux lois en vigueur concernant la propriété industrielle, nous vous informons que les marques et appellations commerciales citées dans notre catalogue appartiennent exclusivement aux fabricants de serrures et aux utilisateurs autorisés. Ces marques ou appellations commerciales sont indiquées à titre d'information pure et simple pour vous permettre de déterminer rapidement les serrures auxquelles nos clés sont destinées. Ce catalogue est réservé exclusivement aux professionnels du taillage de clés qui utilisent les produits Silca.

Les illustrations et les caractéristiques techniques des produits présentés dans ce catalogue sont données à titre indicatif. Bien que les caractéristiques essentielles des produits soient invariables, Silca se réserve le droit d'apporter toutes les modifications qu'elle retiendra nécessaires et opportunes afin d'améliorer la qualité de ses produits. Tous les dessins et photos sont propriété Silca et toute reproduction, même partielle, sans l'autorisation écrite préalable de Silca est interdite conformément aux prescriptions légales. Tout litige est du ressort exclusif des Tribunaux de la circonscription où se trouve le Siège de la Société.

PT IMPORTANTE

Em conformidade com as disposições legais em vigor relativas à propriedade industrial, informamos que as marcas ou as denominações comerciais citadas no nosso catálogo são propriedade exclusiva dos fabricantes de fechaduras e dos utilizadores autorizados. Estas marcas ou denominações comerciais são indicadas só a nível de informação, a fim de reconhecer rapidamente a quais fechaduras se destinam as nossas chaves. Este catálogo é reservado exclusivamente aos profissionais da reprodução de chaves que utilizam os produtos Silca.

As ilustrações e as características técnicas dos produtos apresentados neste catálogo são facultados a título indicativo. Mesmo que as características essenciais dos produtos sejam invariáveis, à Silca reserva-se o direito de modificar ser necessário e oportuno los productos, afim de melhorar a sua qualidade. Todos os desenhos e fotos são propriedade da Silca, e é proibida a sua reprodução mesmo parcial sem a autorização escrita da Silca conforme as prescrições legais. Em caso de litígio fica desde já designado, excluindo qualquer outro, o Tribunal da comarca onde está registada a sede da Silca.