

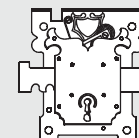

Ornamental keys
Chiavi in stile per mobili
Mobelschlüssel im Stil
Clés traditionnelles pour meubles
Llaves en estilo antiguo para muebles
Chaves para móveis de estilo

FOR:
PER:

MASCHI e FEMMINE per MOBILI



171

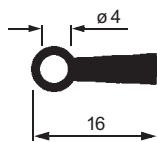
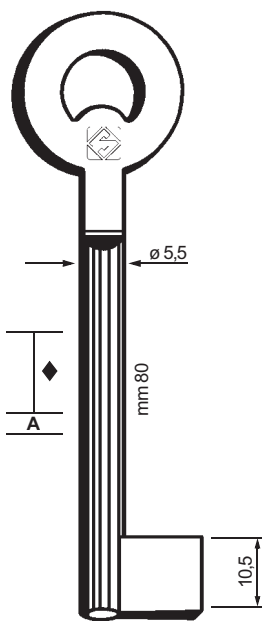

6803

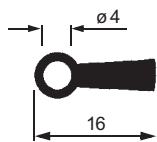
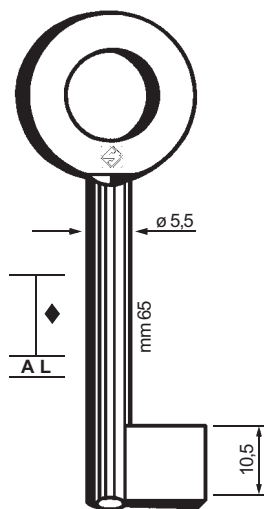

6802

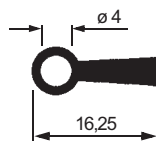
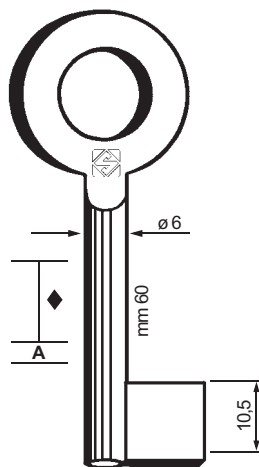

6806

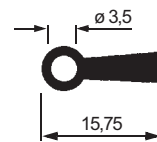
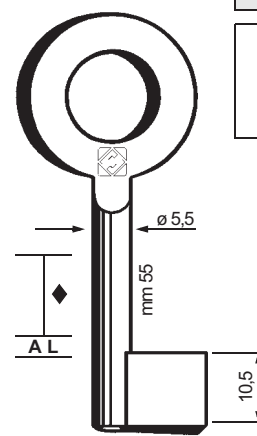

6805

FOR:
PER:

MASCHI e FEMMINE per MOBILI

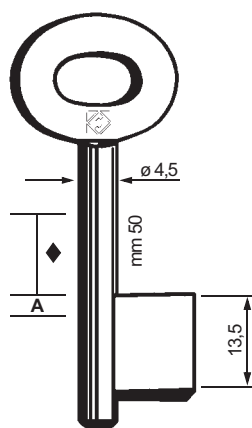

5704

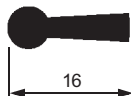
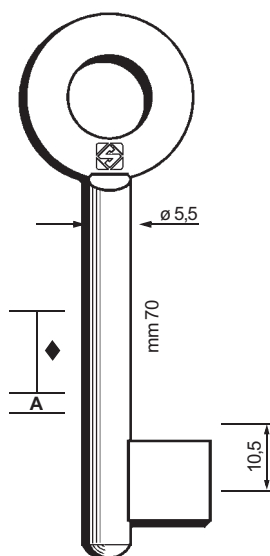

5703

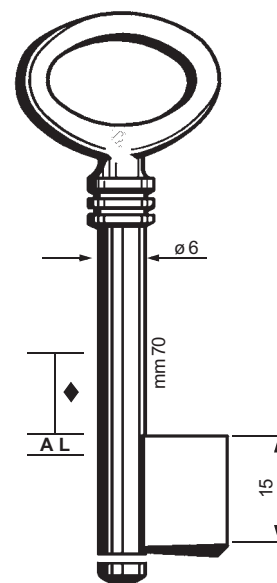

5507

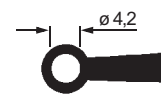

6507

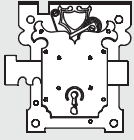

172

FOR:
PER:

FEMMINE per MOBILI

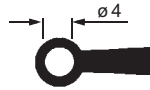
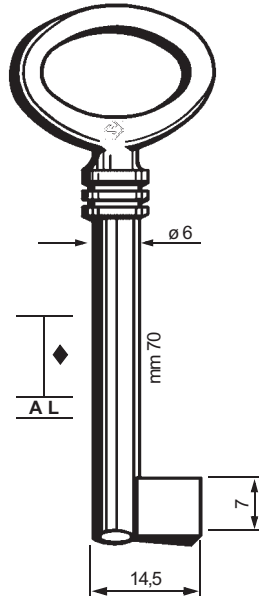

6507/1

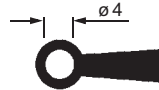
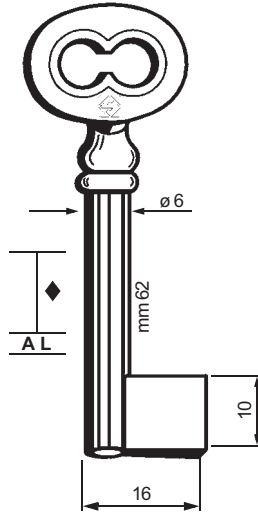

6506

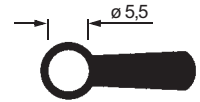
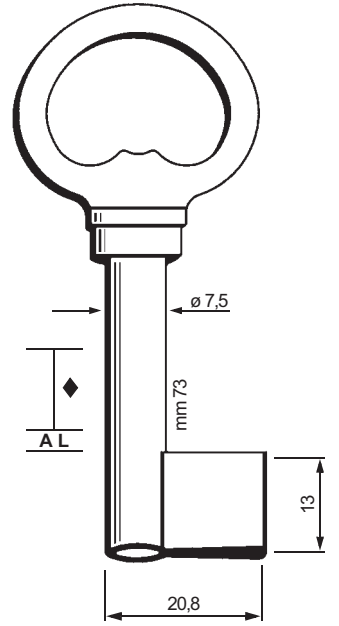

6507/3

FOR: FEMMINE per MOBILI

FEMMINE per MOBILI

FEMMINE per MOBILI

“EURO”

“GEGE”

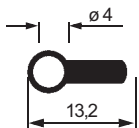
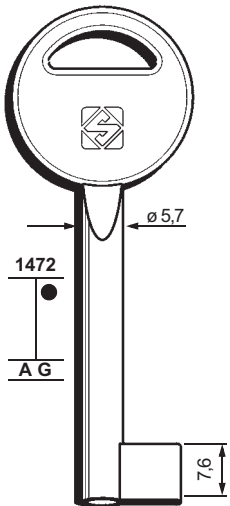

3FB00

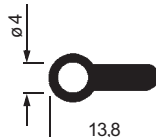
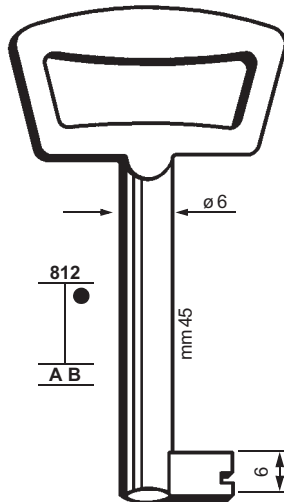

3FEU00

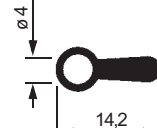
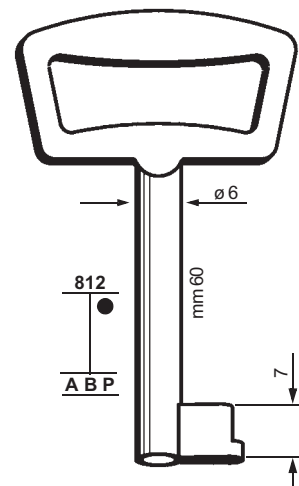

3FGE00

FOR:
PER:

FEMMINE per MOBILI "GEGE"

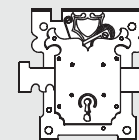



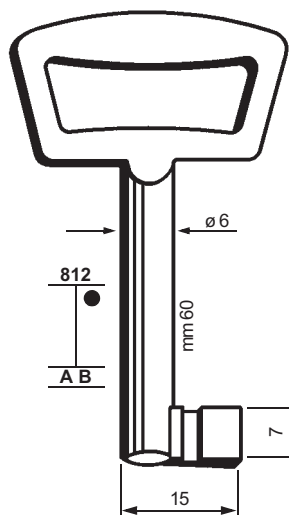

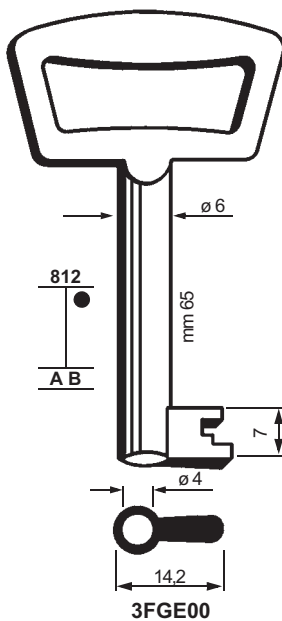

173



-  **3FGE10**
1
-  **3FGE20**
2
-  **3FGE30**
3
-  **3FGE40**
4



- | | |
|---|--|
|  3FGE01
1 |  3FGE04
4 |
|  3FGE02
2 |  3FGE05
5 |
|  3FGE03
3 |  3FGE06
6 |

FOR:
PER:

FEMMINE per MOBILI "MOBELLA"

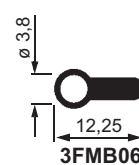
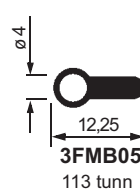
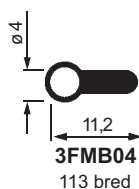
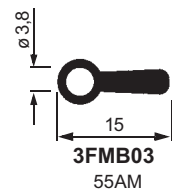
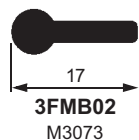
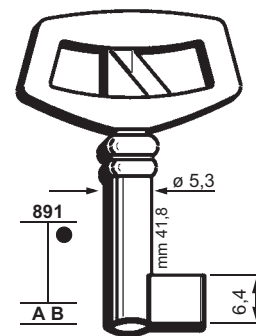
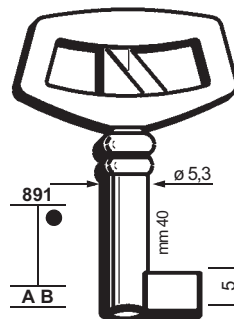
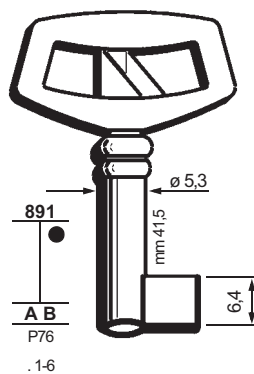
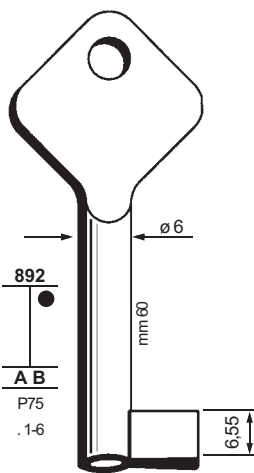
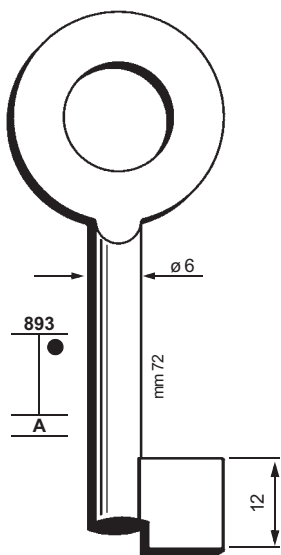

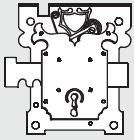

174

FOR:
PER:

FEMMINE per MOBILI "MOBELLA"

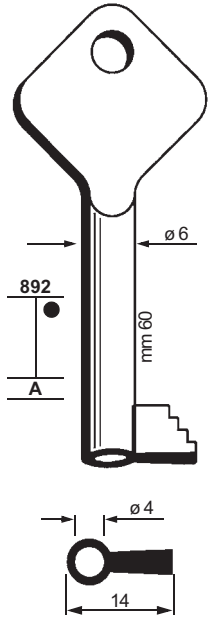

3FMB03-1
55AM-1



3FMB03-2
55AM-2



3FMB03-3
55AM-3



3FMB03-4
55AM-4



3FMB03-5
55AM-5



3FMB03-6
55AM-6

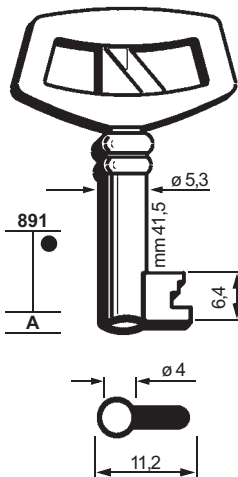

3FMB04-1
113 brend-1



3FMB04-2
113 brend-2



3FMB04-3
113 brend-3



3FMB04-4
113 brend-4



3FMB04-5
113 brend-5



3FMB04-6
113 brend-6

FOR:
PER:

FEMMINE per MOBILI "REFORM"

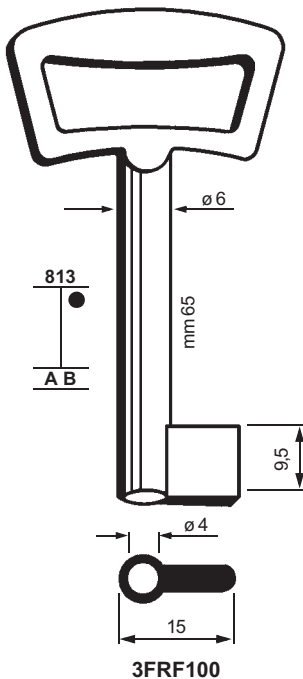

3FRF100

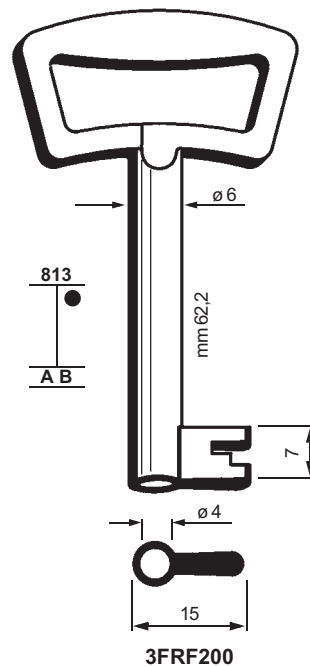

3FRF200

FOR:
PER:

FEMMINE per MOBILI "REFORM"

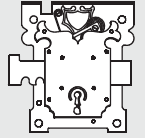

175

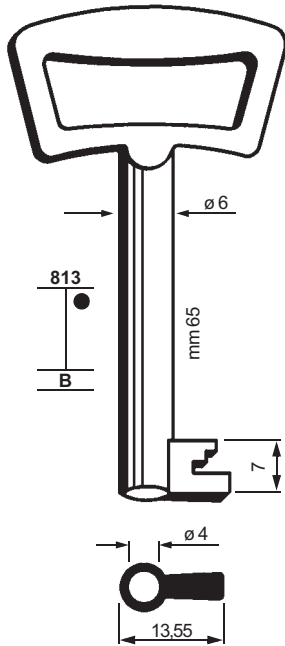

3FRF01
1



3FRF04
2



3FRF02
3



3FRF05
4



3FRF03
5



3FRF06
6

FOR:
PER:

FEMMINE per MOBILI in STILE ADATTABILI

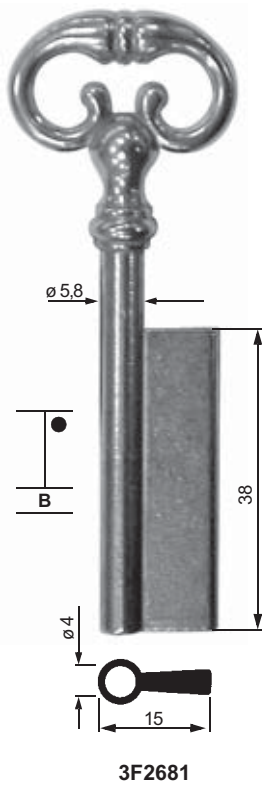

3F2681

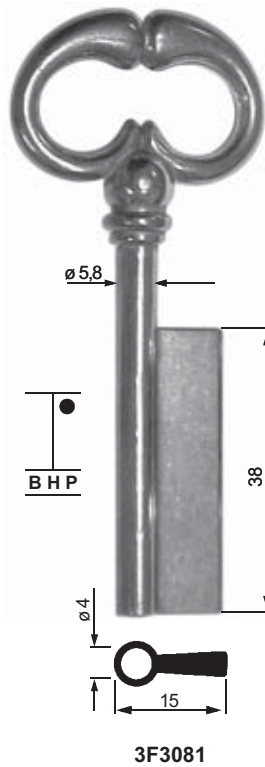

3F3081

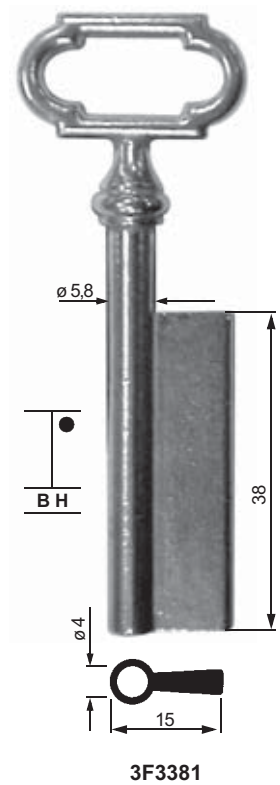

3F3381

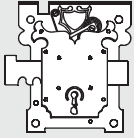

FOR:

PER:

FEMMINE per MOBILI in STILE

ADATTABILI

176

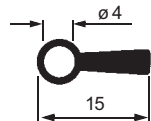
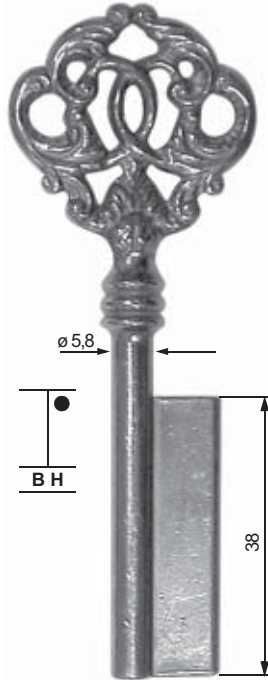

3F6081

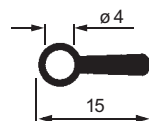
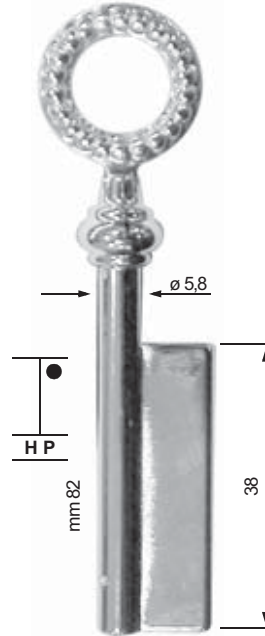

3F4781

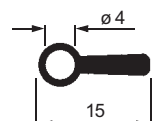
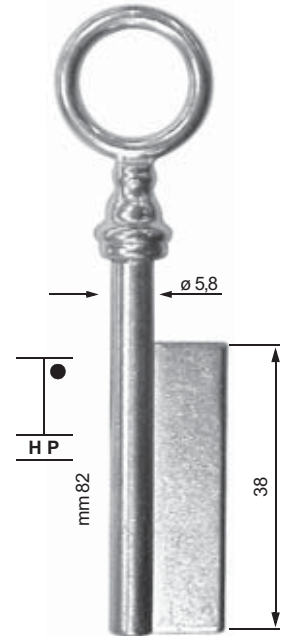

3F4881

FOR:
PER:

FEMMINE per MOBILI in STILE

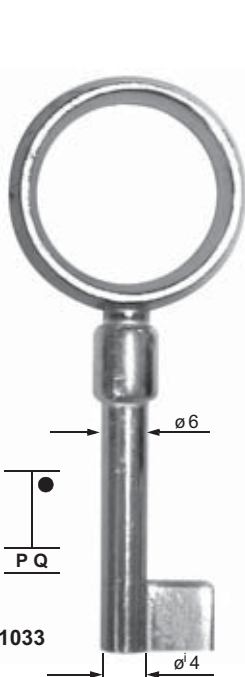

3F1033

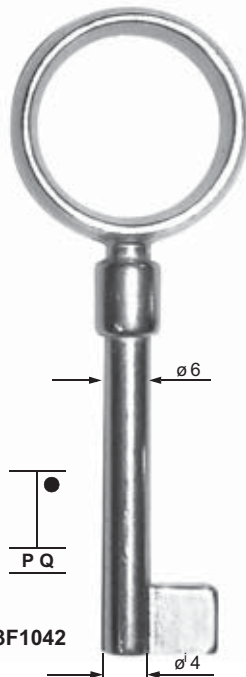

3F1042

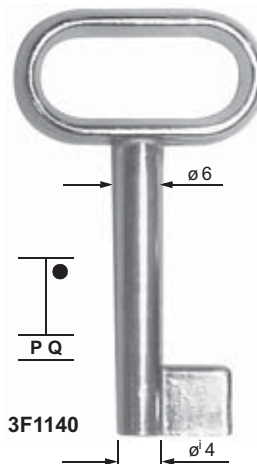

3F1140

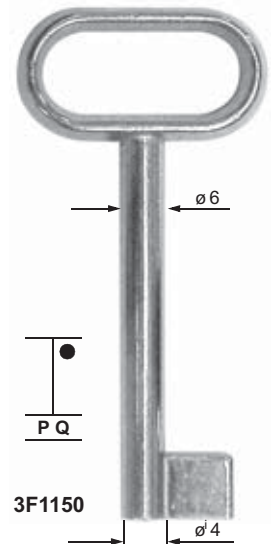

3F1150

FOR:
PER:

FEMMINE per MOBILI in STILE

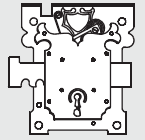

177

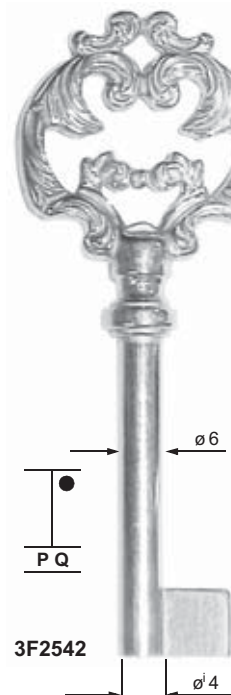
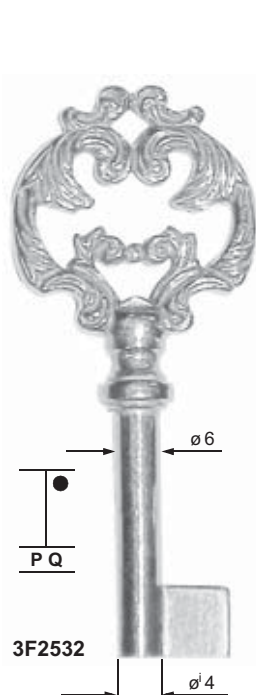
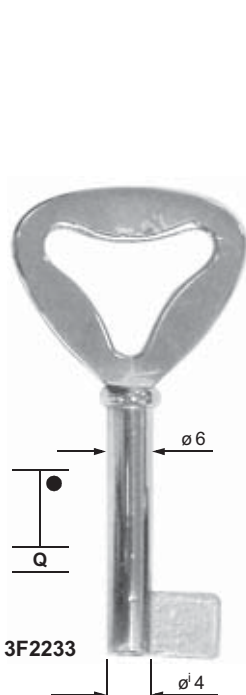
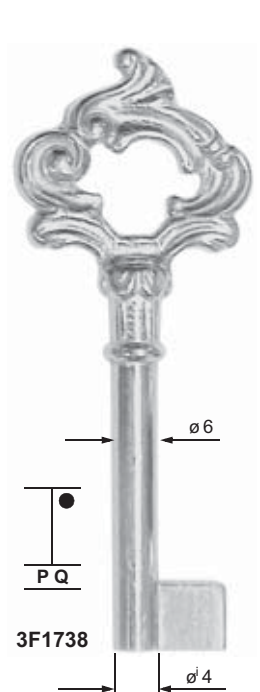
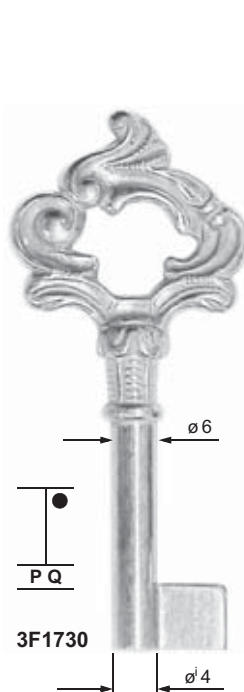
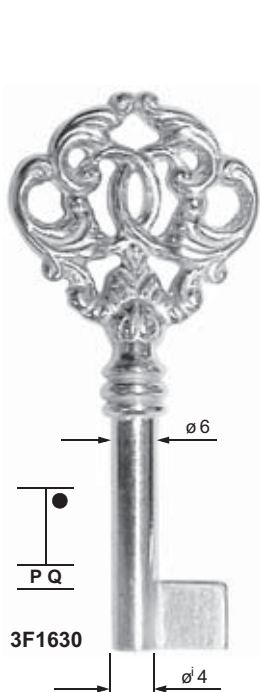
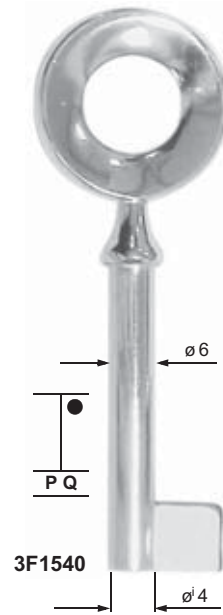
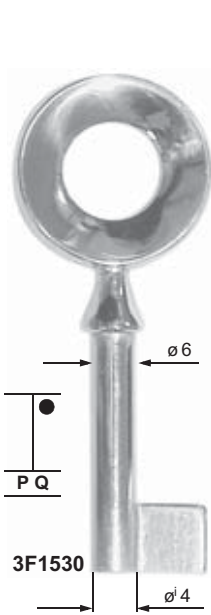
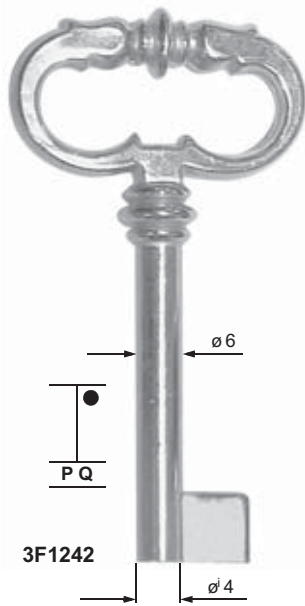
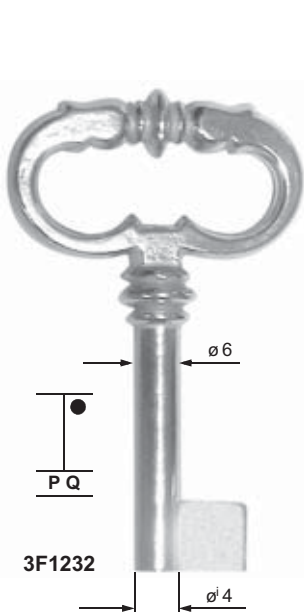

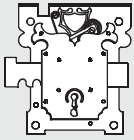

FOR:
PER:

FEMMINE per MOBILI in STILE

178

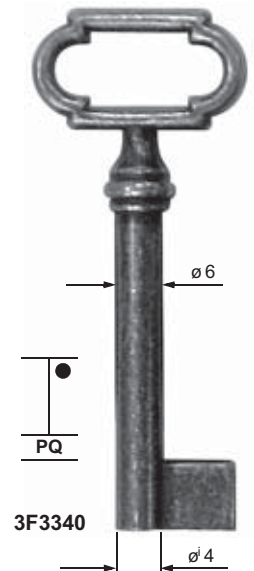
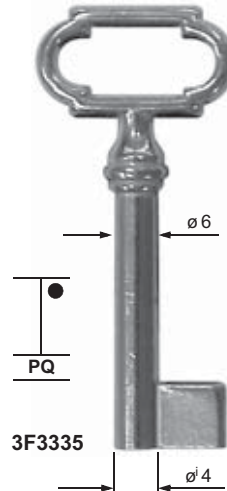
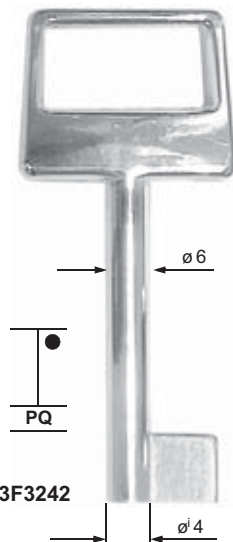
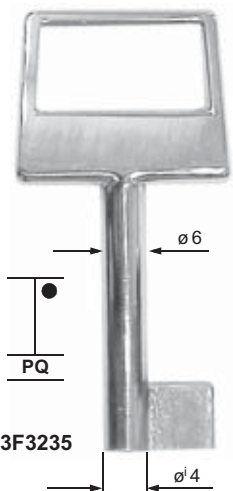
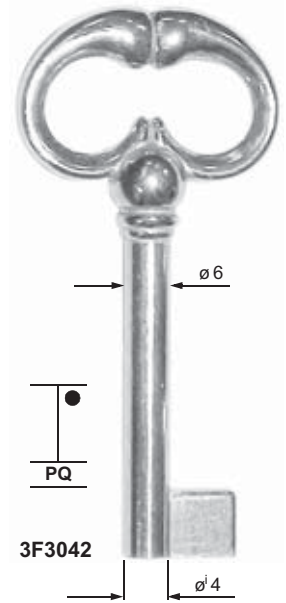
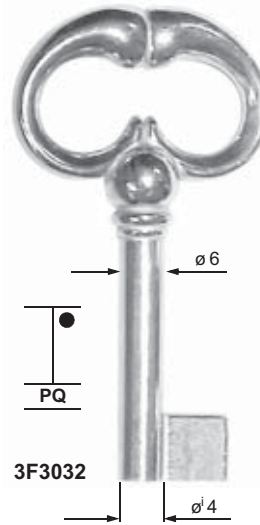
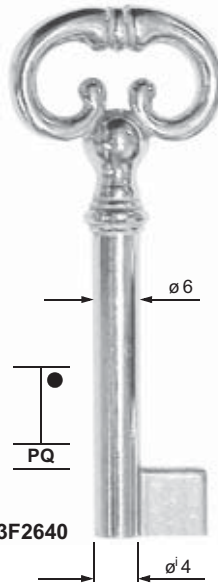
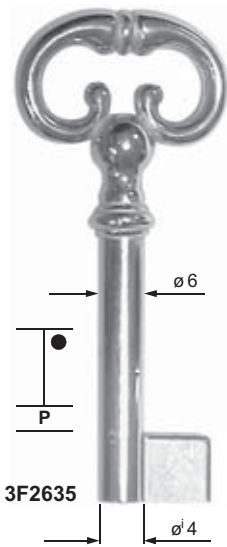
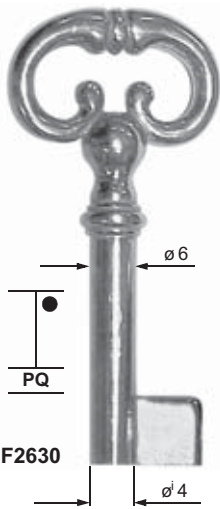
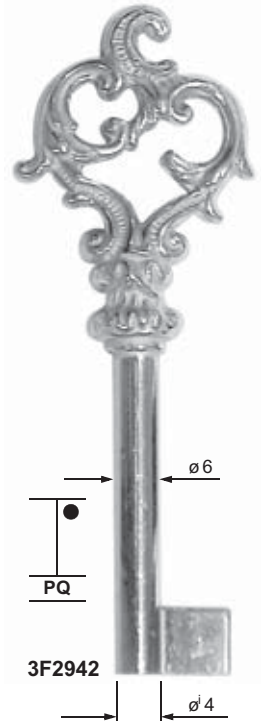
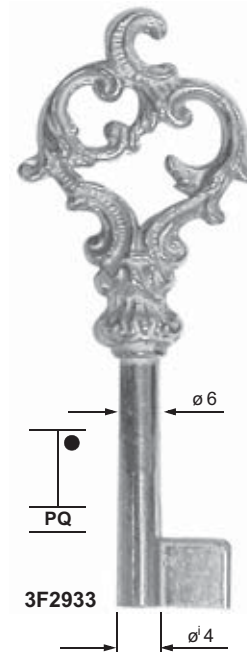
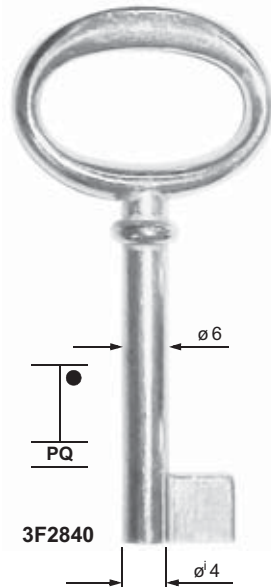
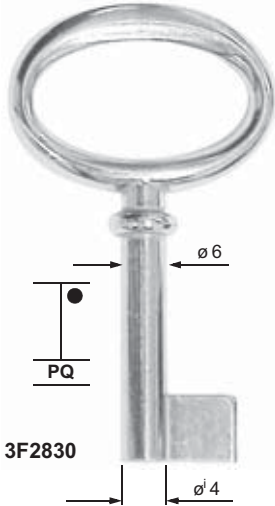

FOR:
PER:

FEMMINE per MOBILI in STILE

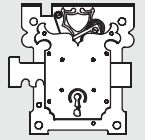

179

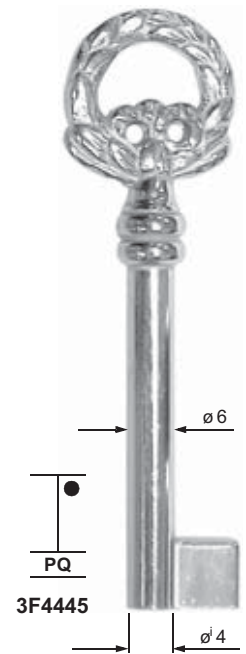
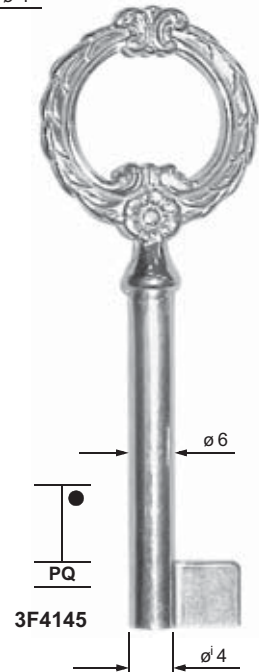
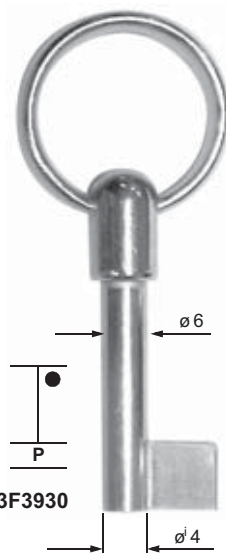
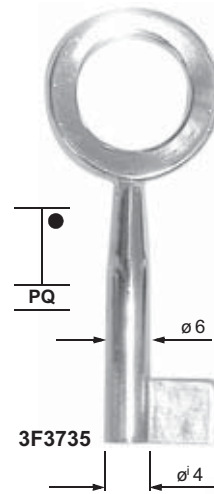

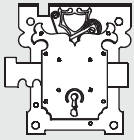

180

FOR:
PER:

FEMMINE per MOBILI in STILE

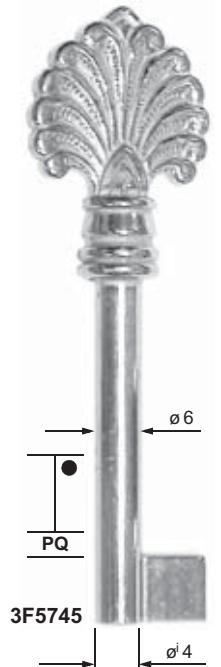
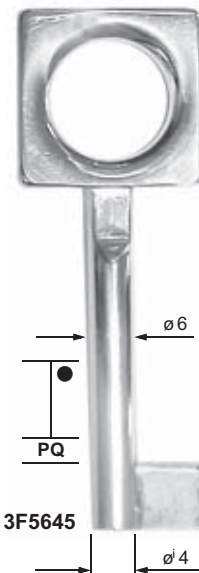
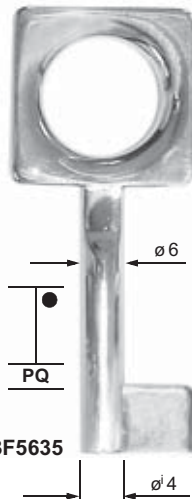
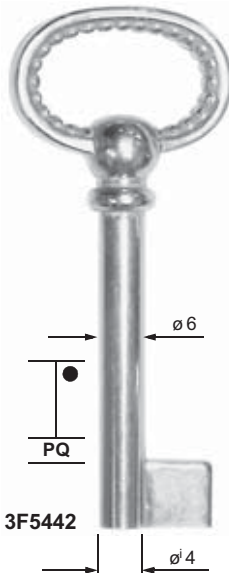
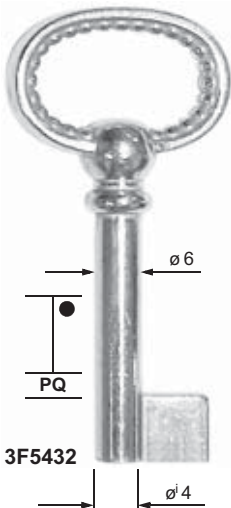
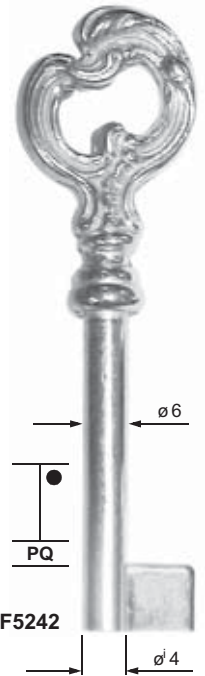
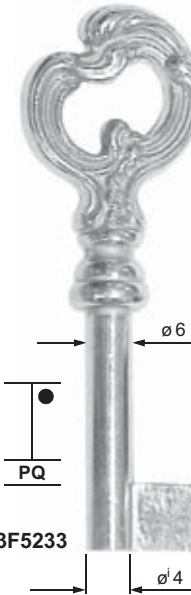
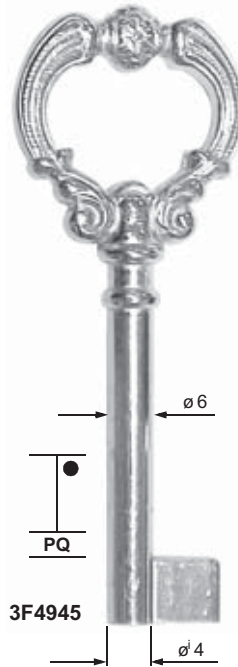
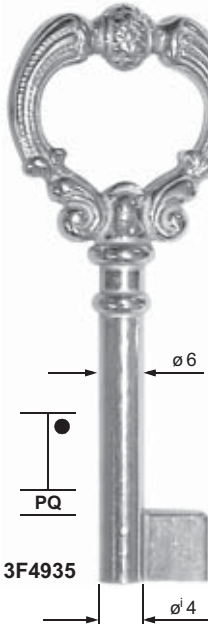
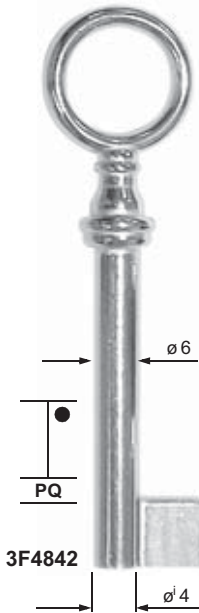
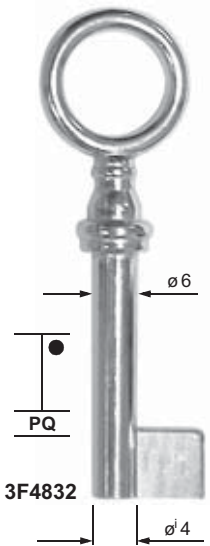
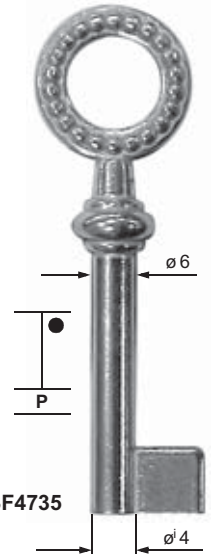
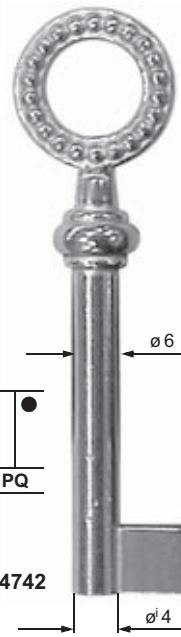
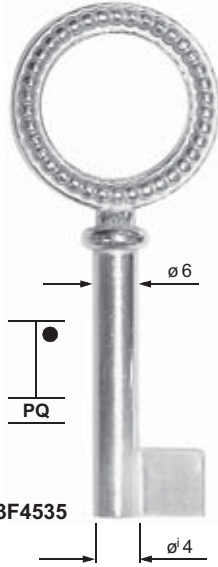
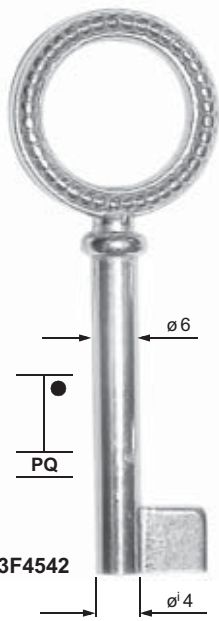

FOR:
PER:

FEMMINE per MOBILI in STILE

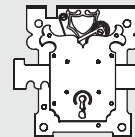

181

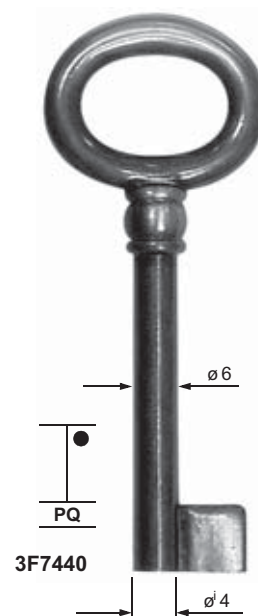
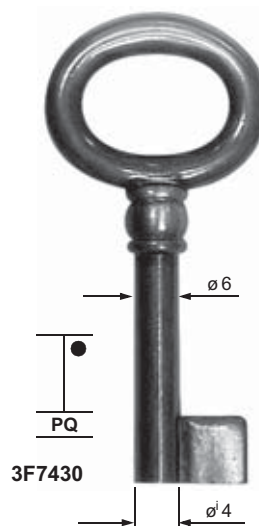
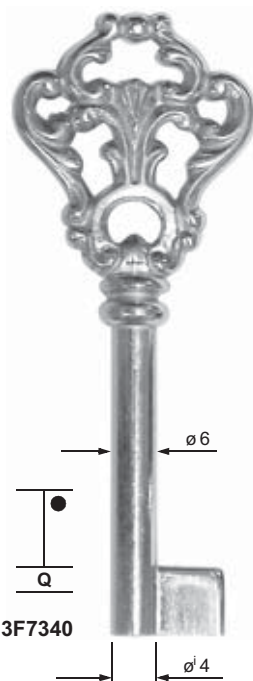
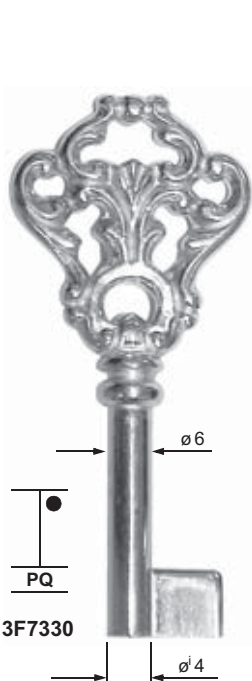
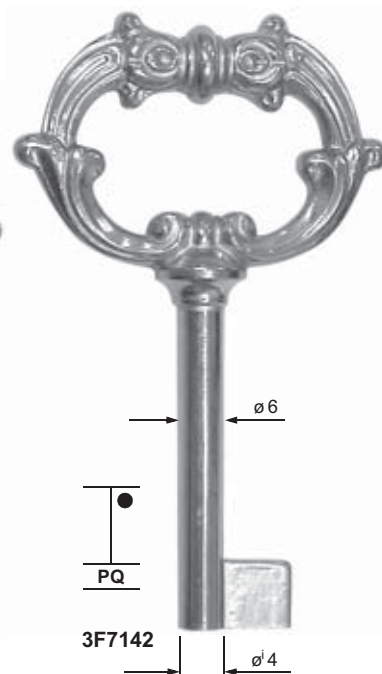
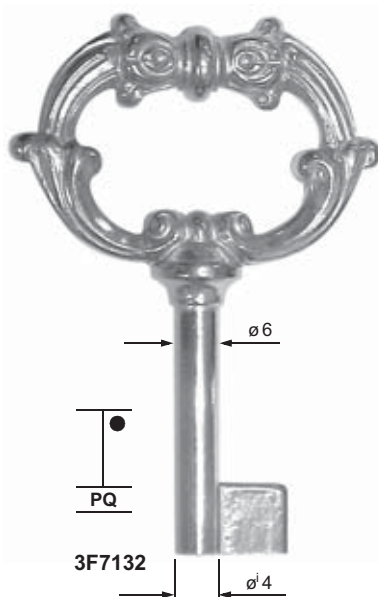
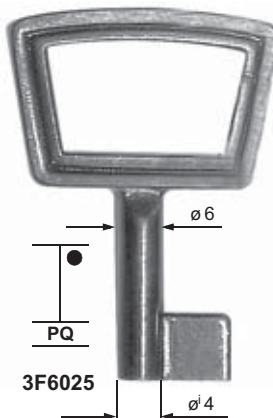
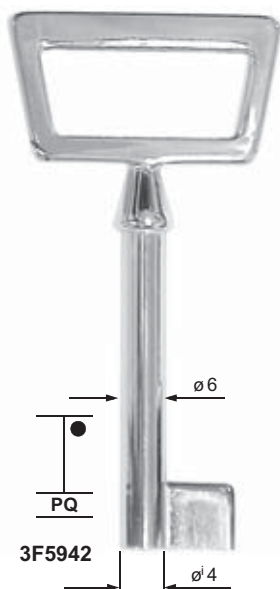

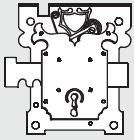

FOR: **FEMMINE SNODATE per MOBILI in STILE**
PER:

182

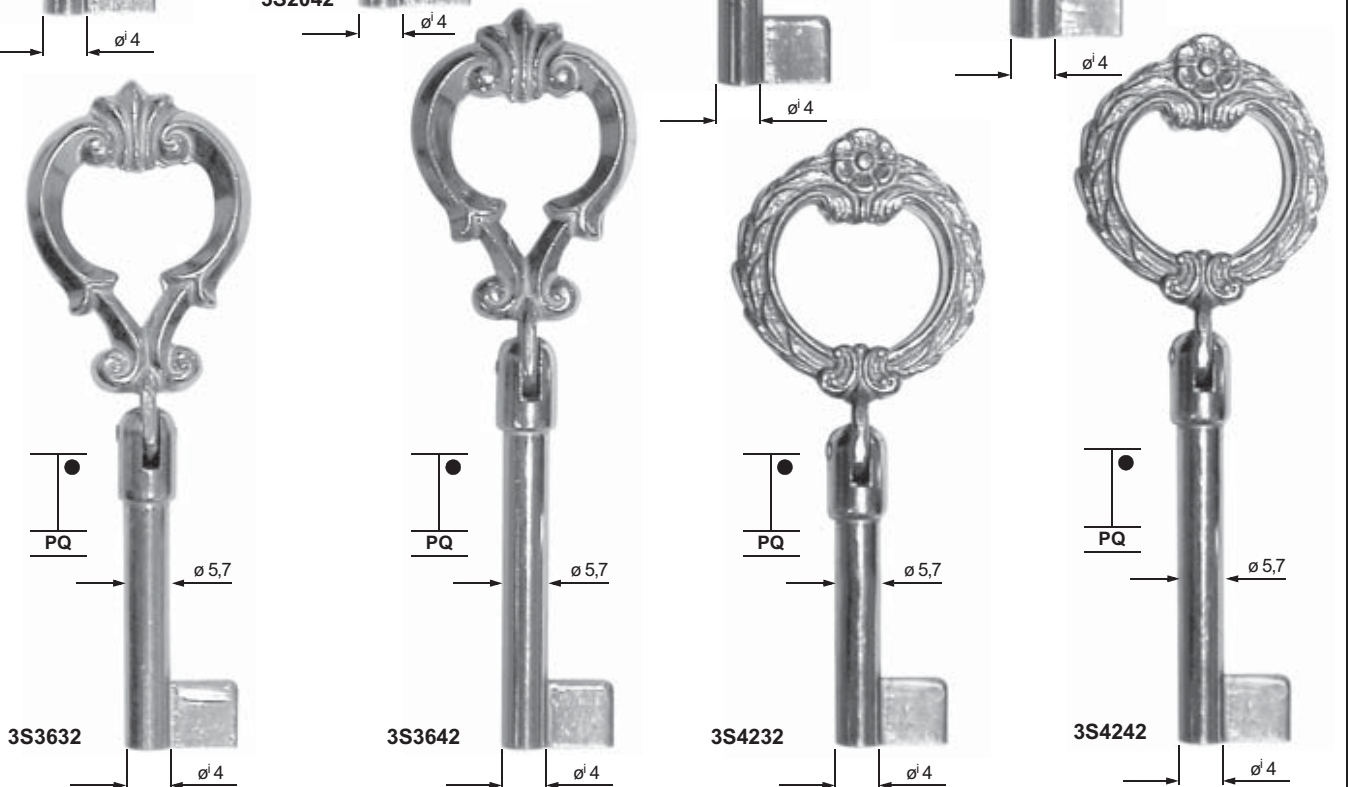

FOR:
PER:

FEMMINE SNODATE per MOBILI in STILE

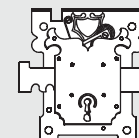

183

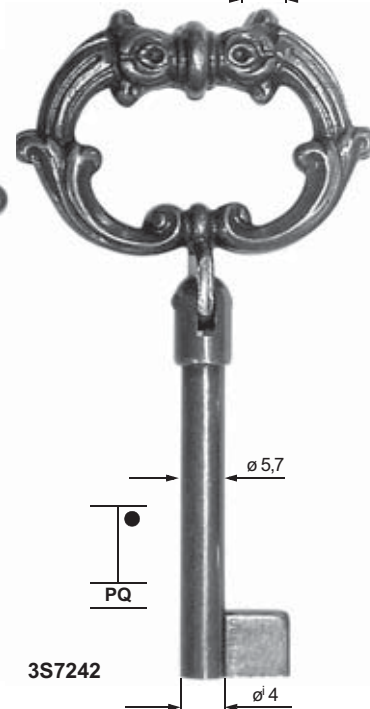
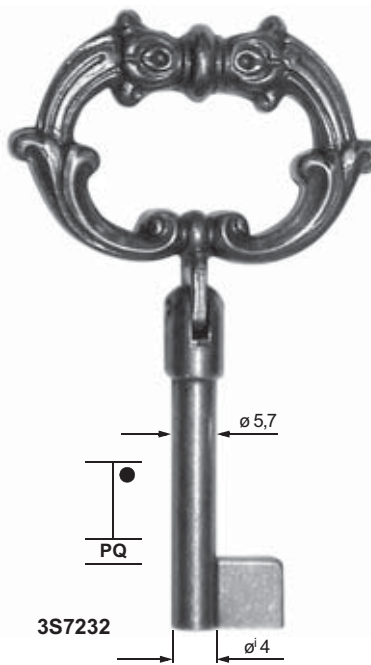
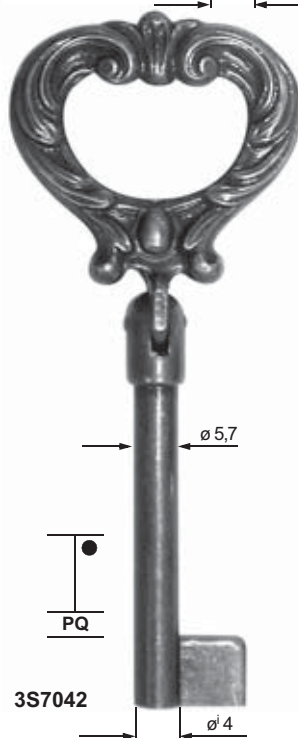
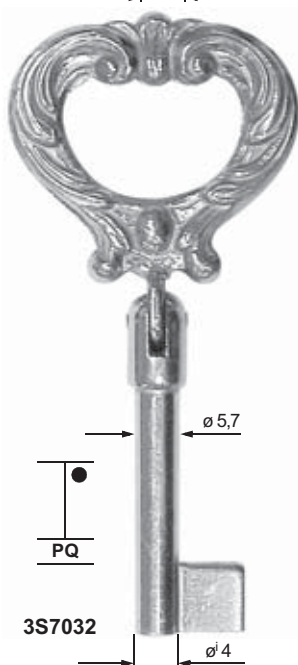
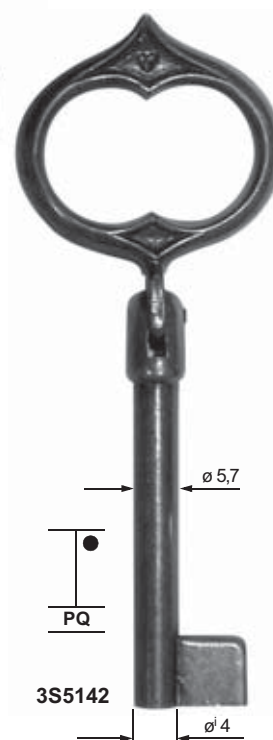
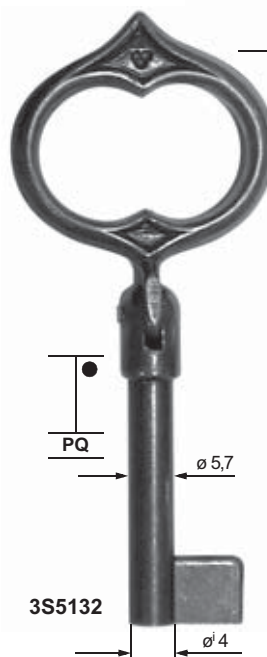
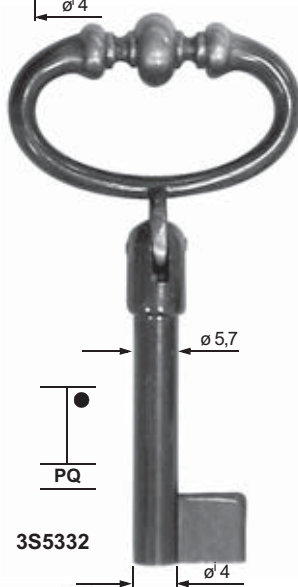
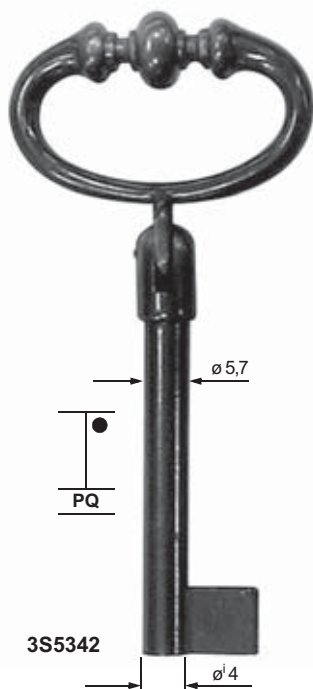
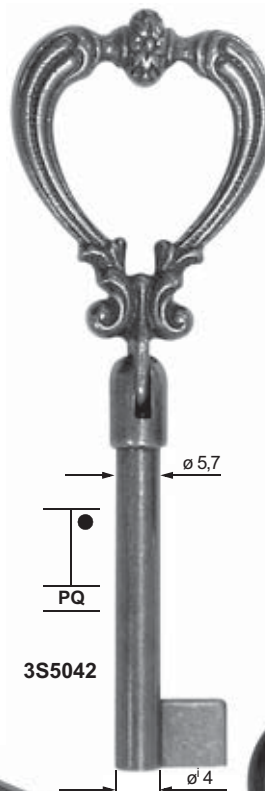
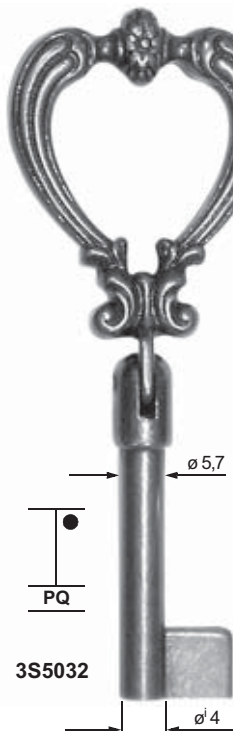
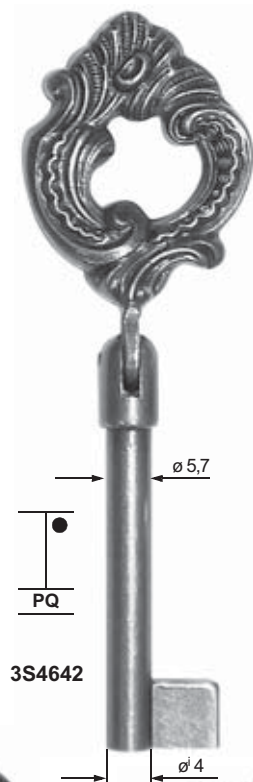
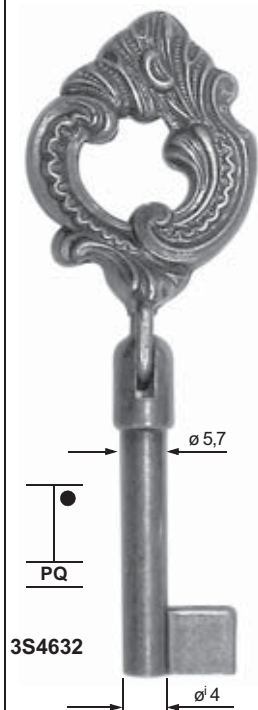

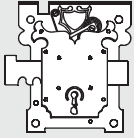

FOR:
PER:

FEMMINE MIGNON per MOBILI in STILE

184

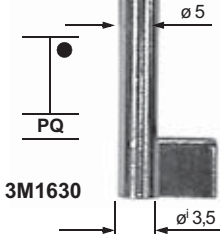

3M1630

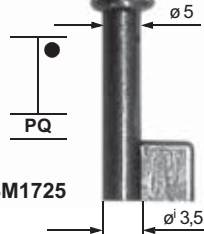

3M1725

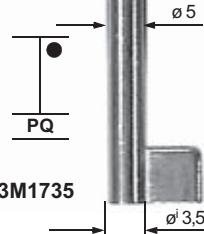

3M1735

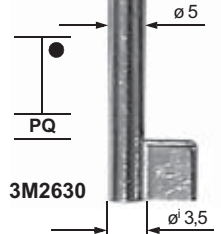

3M2630

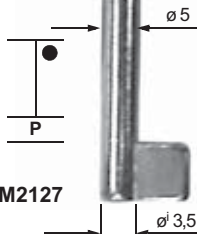
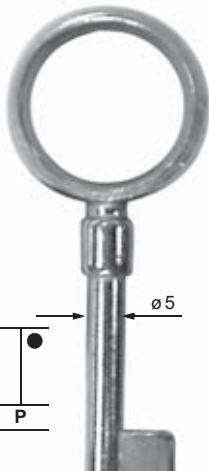

3M2127

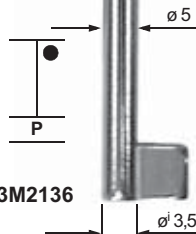

3M2136

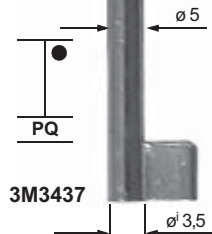
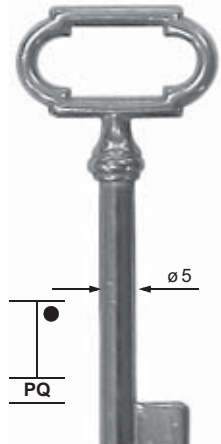

3M3437

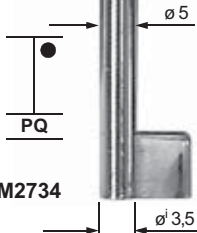

3M2734

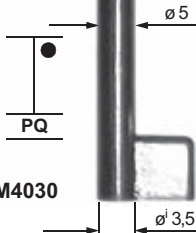
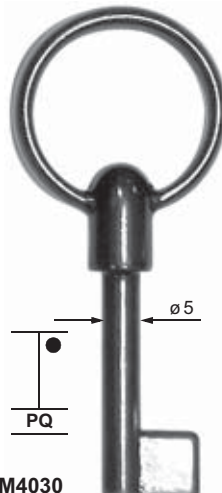

3M4030

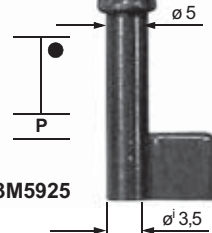
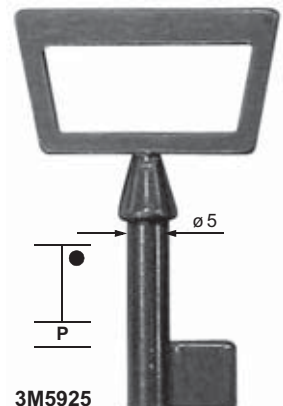

3M5925

FOR:
PER:

TESTE DI CHIAVI

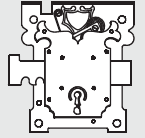

185

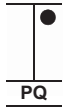

3T16

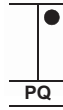
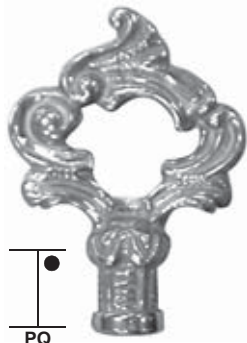

3T17

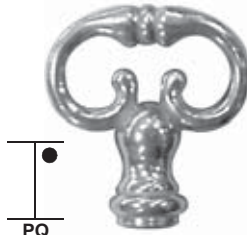

3T26



3T29

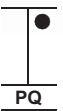

3T30



3T33



3T43



3T44



3T47



3T48



3T52



3T54



3T57

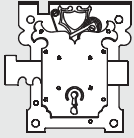

FOR:
PER:

per SERRATURE PATENT

186

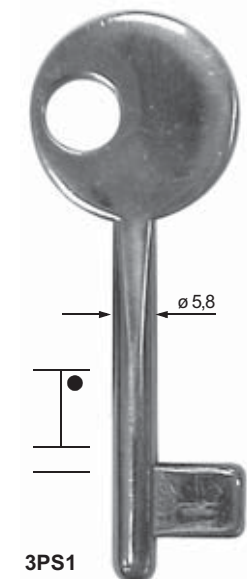
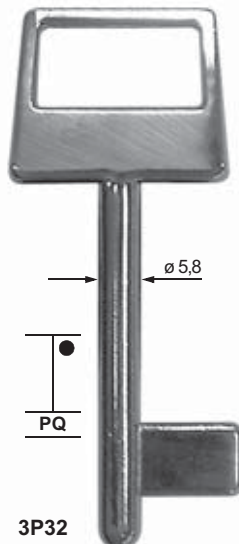
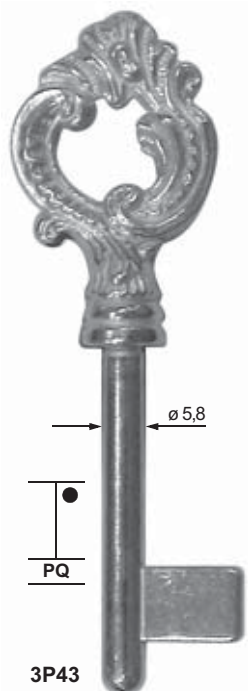
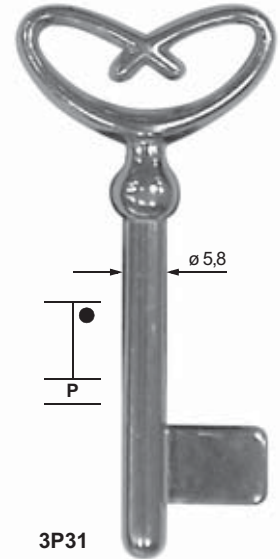
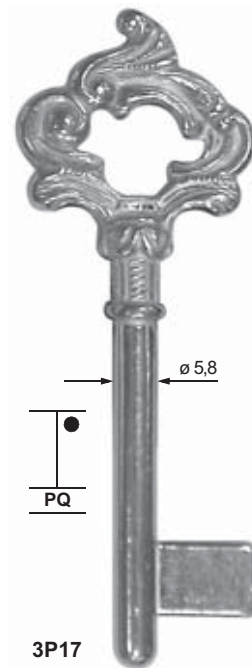
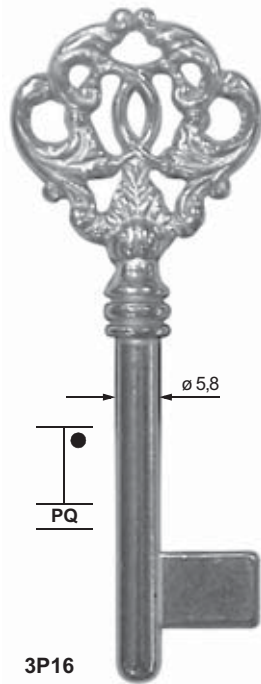



GB IMPORTANT

All information and illustrations in this catalogue are for guidance only.

Silca reserves the right to alter products designs, dimensions or info to improve the products quality.

The contents of this catalogue are fully protected by Copyright and may not be copied or reproduced in any form, without written permission from Silca.

Any infringements will be dealt with under Italian law.

F IMPORTANT

Les illustrations et les caractéristiques techniques des produits présentés dans ce catalogue sont données à titre indicatif.

Bien que les caractéristiques essentielles des produits soient invariables, Silca se réserve le droit d'apporter toutes les modifications qu'elle retiendra nécessaires et opportunes afin d'améliorer la qualité de ses produits.

Tous les dessins et photos sont propriété Silca et toute reproduction, même partielle, sans l'autorisation écrite préalable de Silca est interdite conformément aux prescriptions légales. Tout litige est du ressort exclusif des Tribunaux de la circonscription où se trouve le Siège de la Société.

I IMPORTANT

Le illustrazioni e i dati tecnici dei prodotti contenuti nel catalogo debbono considerarsi indicativi.

Silca si riserva il diritto, ferme restando le caratteristiche essenziali dei prodotti, di apportare tutte le modifiche che ritiene necessarie e opportune al fine di migliorare la qualità dei prodotti.

Tutti i disegni e le fotografie sono di proprietà di Silca, ogni riproduzione anche parziale, senza autorizzazione scritta della Silca è vietata secondo termini di legge.

Per qualsiasi controversia competenti sono gli Uffici Giudiziari dove ha sede l'Azienda, con espressa esclusione di qualsiasi altro foro.

E IMPORTANTE

Las ilustraciones y los datos técnicos de los productos en este catálogo son indicativos.

La Silca se reserva el derecho, quedando invariadas las características principales de los productos, de modificar todo lo que considere necesario y oportuno para mejorar la calidad de sus artículos.

Todos los dibujos y las fotografías pertenecen a la Silca; según determina la Ley, se prohíbe toda reproducción aunque parcial, sin autorización por escrito de la Silca.

En caso de disputas la competencia es de las autoridades judiciales donde está domiciliada la firma, excluyendo cualquier otro foro.

D WICHTIG

Die Abbildungen und technischen Daten des Katalogs sind nur zur Information.

Silca behält sich vor, etwaige Änderungen am Produkt, die zur Verbesserung desselben beitragen vorzunehmen.

Alle Zeichnungen und Fotos sind Besitz der Firma Silca, jede Reproduktion, auch teilweise, ist ohne schriftliche Erlaubnis der Firma Silca gesetzlich untersagt.

Im Falle von Streitfragen ist der Gerichtshof des Firmensitzes zuständig; jeder andere Gerichtshof ist ausgeschlossen.

P IMPORTANTE

As ilustrações e as características técnicas dos produtos apresentados neste catálogo são facultados a título indicativo.

Mesmo que as características essenciais dos produtos sejam invariáveis, à Silca reserva-se o direito de modificar ser necessário e oportuno los productos, afim de melhorar a sua qualidade.

Todos os desenhos e fotos são propriedade da Silca, e é proibida a sua reprodução mesmo parcial sem a autorização escrita da Silca conforme as prescrições legais.

Em caso de litígio fica desde já designado, excluindo qualquer outro, o Tribunal da comarca onde está registada a sede da Silca.

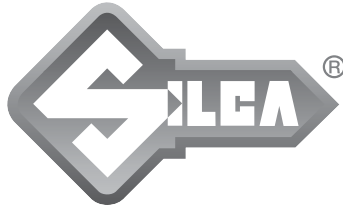
**GB IMPORTANT**

In compliance with current regulations relating to industrial property, we hereby state that the trade-marks or trade names mentioned in our catalogue are the exclusive property of authorized manufacturers of locks and users.

Said trade-marks or trade names are nominated only for the purposes of information so that any lock for which our keys are made can be rapidly identified.

This catalogue is reserved exclusively for professional key cutters who use Silca products.

I IMPORTANT

In conformità alle disposizioni legali in vigore relative alle proprietà industriali, informiamo che i marchi o le denominazioni commerciali citate nel nostro catalogo sono di proprietà esclusiva dei fabbricanti di serrature e degli utilizzatori autorizzati.

Questi marchi o denominazioni commerciali sono indicati a titolo di semplice informazione, con lo scopo di riconoscere velocemente a quali serrature le nostre chiavi sono destinate.

Questo catalogo è esclusivamente riservato ai professionisti della riproduzione chiavi che utilizzano i prodotti Silca.

D WICHTIG

Gemäß den derzeit geltenden Normen bezüglich des Industrieigentums teilen wir Ihnen mit, daß die im vorliegenden Katalog angeführten Markennamen oder Handelsmarken ausschließliches Eigentum der Schloßhersteller und zugelassenen Fachhändler sind.

Diese Markenbezeichnungen oder Handelsmarken sind nur zur Information angeführt, mit dem Zweck, schnell erkennen zu können, zu welchem Schloß unsere Schlüssel gehören.

Der vorliegende Katalog ist ausschließlich an Schlüsselkopier-Fachgeschäfte, die Silca Produkte benutzen, gerichtet.

F IMPORTANT

Conformément aux lois en vigueur concernant la propriété industrielle, nous vous informons que les marques et appellations commerciales citées dans notre catalogue appartiennent exclusivement aux fabricants de serrures et aux utilisateurs autorisés.

Ces marques ou appellations commerciales sont indiquées à titre d'information pure et simple pour vous permettre de déterminer rapidement les serrures auxquelles nos clés sont destinées.

Ce catalogue est réservé exclusivement aux professionnels du taillage de clés qui utilisent les produits Silca.

E IMPORTANTE

En conformidad con las vigentes disposiciones de ley sobre propiedad industrial, las marcas y denominaciones comerciales citadas en nuestro catálogo se declaran de propiedad exclusiva de los fabricantes de cerraduras y los utilizadores autorizados.

Dichas marcas o denominaciones comerciales se citan por simple información, al objeto de hacer comprender sin dificultad a qué cerraduras van destinadas nuestras llaves.

Este catálogo está reservado exclusivamente a los profesionales de la reproducción de llaves que utilizan los productos Silca.

P IMPORTANTE

Em conformidade com as disposições legais em vigor relativas à propriedade industrial, informamos que as marcas ou as denominações comerciais citadas no nosso catálogo são propriedade exclusiva dos fabricantes de fechaduras e dos utilizadores autorizados.

Estas marcas ou denominações comerciais são indicadas só a nível de informação, a fim de reconhecer rapidamente a quais fechaduras se destinam as nossas chaves.

Este catálogo é reservado exclusivamente aos profissionais da reprodução de chaves que utilizam os produtos Silca.