



Household Keys
Chiavi Piatte
Flachschlüssel
Clés plates
Llaves Planas
Chaves Planas

PER:
FOR:

3F



3

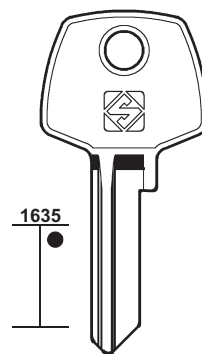
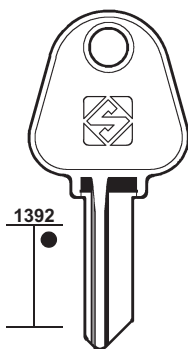
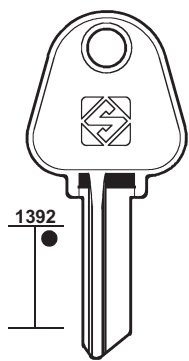
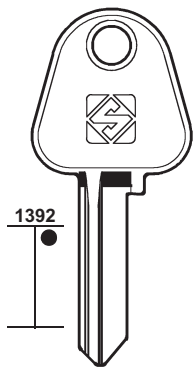

PER / FOR

3F (BR)

3M (PRC)

333 (IL)
+ CORNI (55)

555 (RC)
+ CINA (48)

606 (RA)

PER:
FOR:

3F

3M

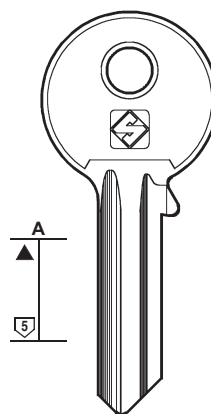
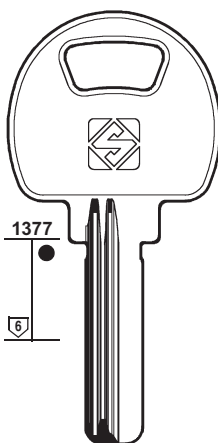
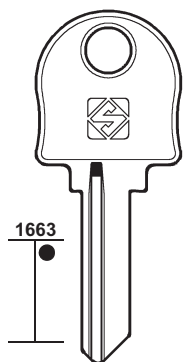
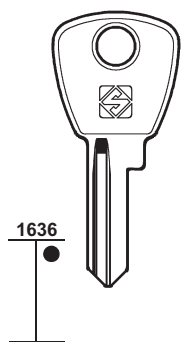

PER:
FOR:

333

606

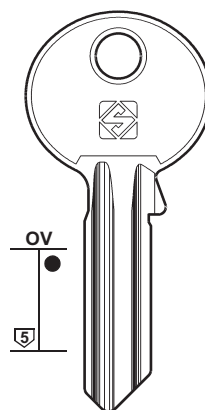
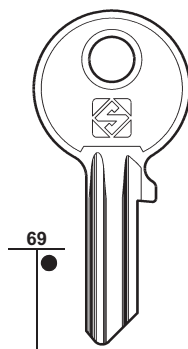
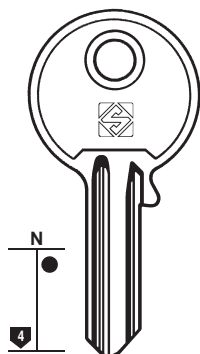
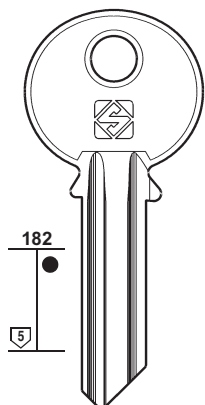



4

PER / FOR

aaa (IL)

ABA (GR)

ABBES (GB)

LAS (111)

ABC (E)

BAGEM

ABLOY (FIN)

KITTY

VIRO

PER:
FOR: aaa

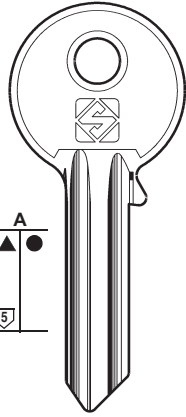

AAA1

ABA

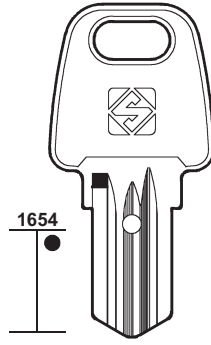

AAB1

ABC

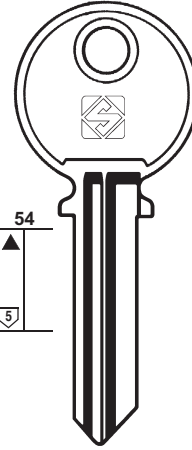

AC1

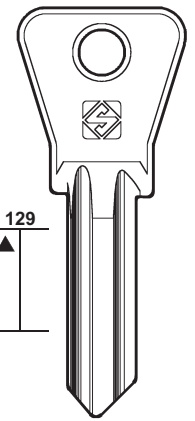

AC2

BAGEM

PER:
FOR:

ABLOY

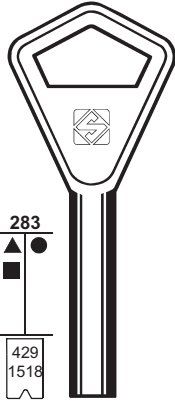

AY1

..... (DX)
..... (SX)
0-1-2-3-4-5-6-7-8-9

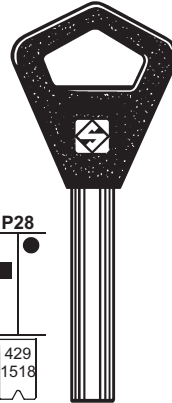

AY1P

..... (DX)
..... (SX)
0-1-2-3-4-5-6-7-8-9



KITTY - VIRO

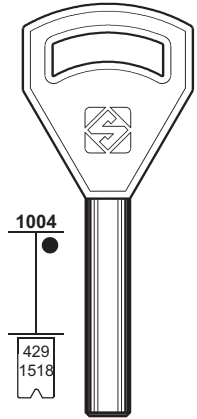

AY11

PER:
FOR:

ABLOY

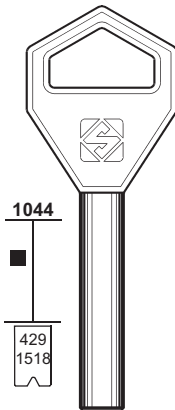

AY12

..... (DX)
..... (SX)
0-1-2-3-4-5-6-7-8-9

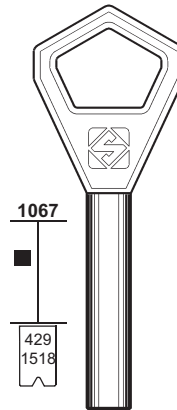

AY16

..... (DX)
..... (SX)
0-1-2-3-4-5-6-7-8-9

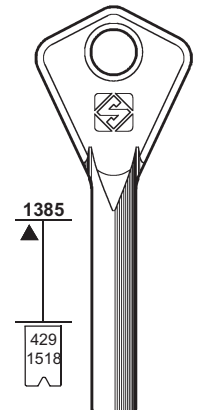

AY30



PER:
FOR:

ABLOY

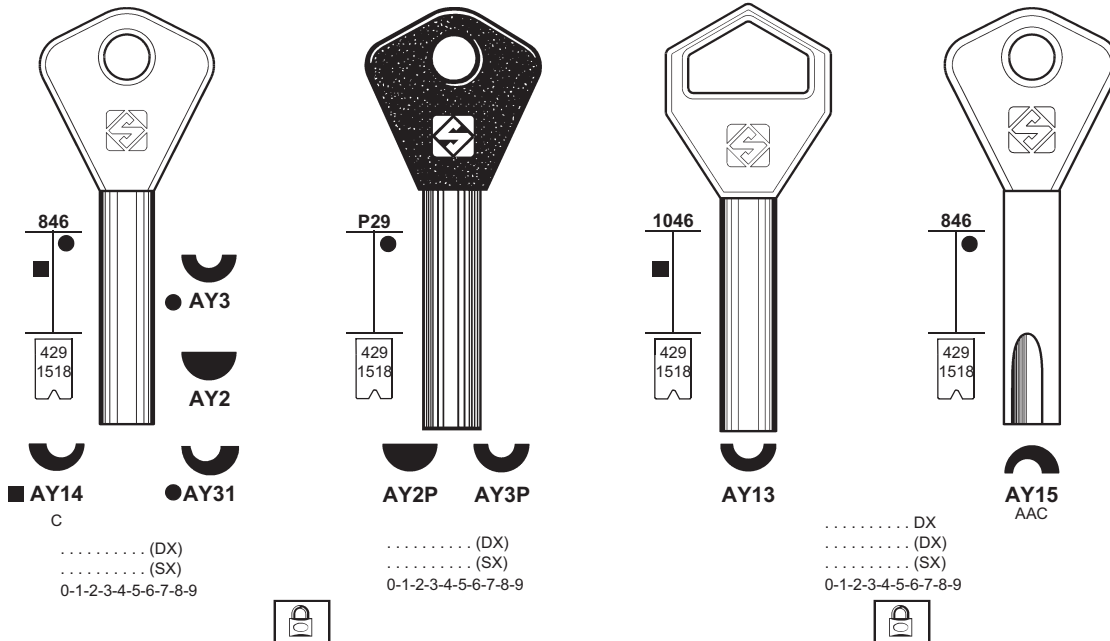

5

PER / FOR

ABLOY (FIN)

PER:
FOR:

ABLOY

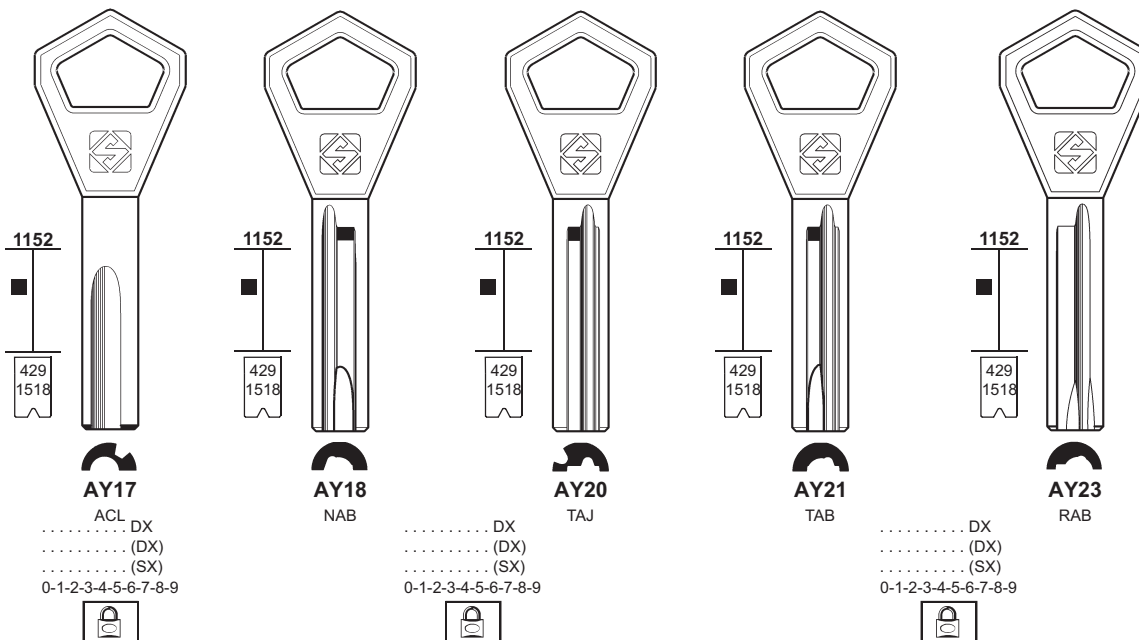

PER:
FOR:

ABLOY

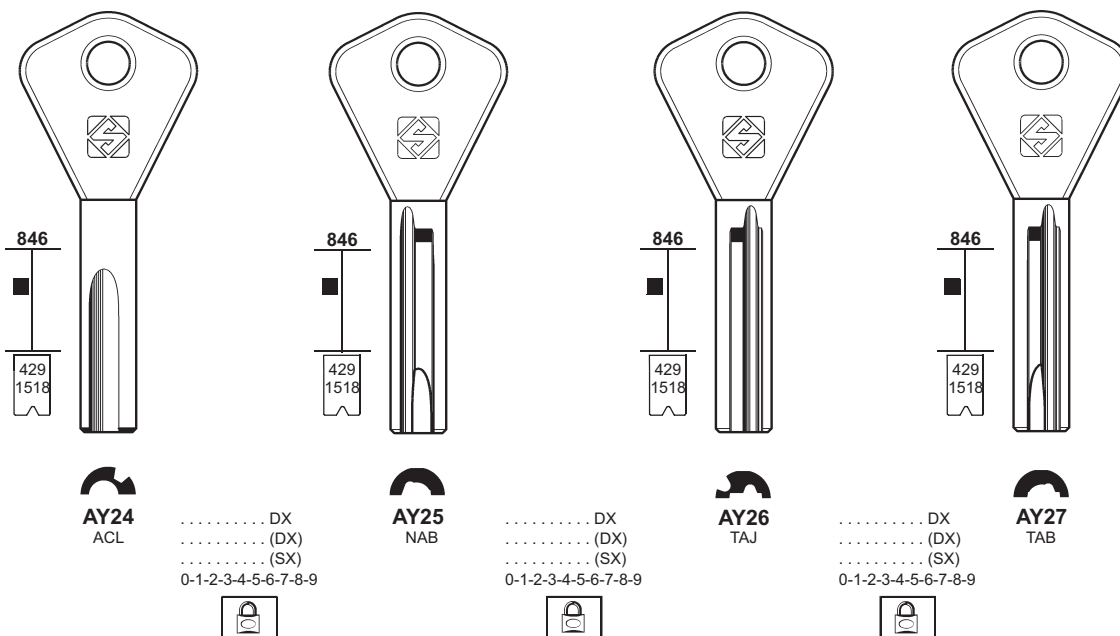



6

PER / FOR

ABLOY (FIN)

ABT (I)

+ VIRO (187)

ABUS (D)

CISA

JPM

OTHMER

TOP

+ G.R. (90)

+ GUARD (90-91)

+ PFAFFENHAIN (141)

+ YALE (194)

PER:
FOR:

ABLOY

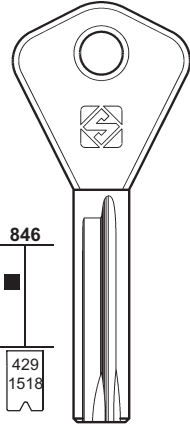

846
429
1518



AY28
RAB

..... DX
..... (DX)
..... (SX)
0-1-2-3-4-5-6-7-8-9

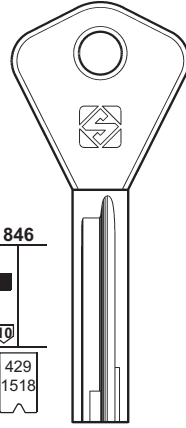

846
429
1518



AY29
RAG

..... (DX)
..... (SX)
0-1-2-3-4-5-6-7-8-9

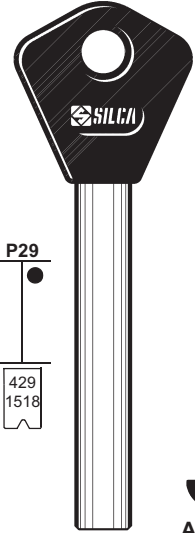

P29
429
1518



AY10P



PER:
FOR:

ABUS

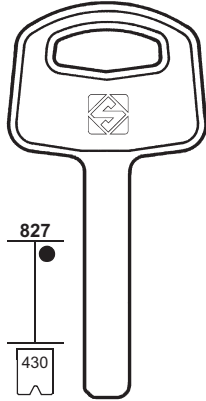

827
430

AB32
.....
1-2-3-4-5-6

GRANIT

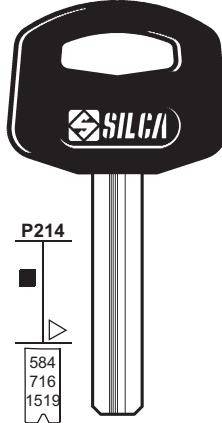

P214
584
716
1519

AB38P
.....
1-2-3-4-5-6

ABUS PLUS

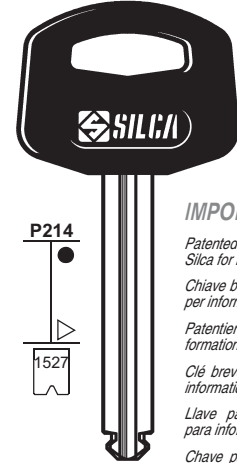

P214
1527

AB60P
.....
1-2-3-4-5-6

IMPORTANT!

Patented key, please contact Silca for information.
Chiave brevettata, rivolgersi a Silca per informazioni.
Patentierter Schlüssel. Bitte, für Informationen an Silca sich wenden.
Clé brevetée, contacter Silca pour information.
Llave patentada, contactar Silca para informaciones.
Chave patenteada, por favor contacte Silca para informação.

PER:
FOR:

ABUS

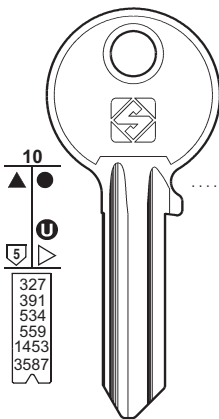

10
327
391
534
559
1453
3587

AB1R
.....
1-2-3-4-5-6

AB1
.....
1-2-3-4-5-6

BJ 1-20728
..... 1-2-3-4-5-6-7-8-9
C42 1-2-3-4-5-6-7-8-9
P
00000-02360

AY 1-6032
BA 1-6032
BB 1-6032
BC 1-6032
BD 1-6032
BK 1-6032
BL 1-6032
BM 1-6032
BN 1-6032
BP 1-6032
BQ 1-6032
BR 1-6032
BS 1-6032
BT 1-6032
BU 1-6032
BY 1-6032
SA 1-6032
SB 1-6032

AB10R
F3
BCISS 1-6032
F2D 1-6032

AB10
F3
..... AA 000-999
..... AB 000-999
..... AF 001-954
..... AM 001-988
..... AN 001-958
..... AV 001-999
..... BB 001-636
..... BK 001-997
..... BL 001-998
..... BM 002-999
..... BP 001-331
..... BQ 001-398
..... BR 001-397
..... BT 000-999
..... BU 000-999
..... BV 000-999
..... GF 001-892
..... GG 001-879
..... GH 001-359
..... GJ 001-358
..... GK 001-308
..... GM 001-999
BCISS 1-6032
F2C 1-6032

AB8

AB21
X4D

AB22

AB78R

AB33

AB26
OTHMER
B09

AB8R

AB21R
X4S

AB25R

AB47R

AB34
B49

AB36

AB37

AB44

AB42R

AB34
B49

AB75

AB36R

AB37R

AB44R

AB42R

AB63

AB67

JM1
F3

AY-BA
BB-BC
BD-DK
BL-BM
BN-BP
BQ-BR
BS-BT
BU-BY
SA-SB
F3C
..... 1-6032

TOP1R
TOP

JM1R
F3
F3D 1-6032

JM2

JM2R

CISA - JPM - OTHMER - TOP

PER:
FOR:

ABUS

Key 1: Dimensions OV, 5. Bit patterns: AB79RX, AB70X, AB69X, AB68X, AB1X, AB1RX, AB55X. Brand: BRICARD.

Key 2: Dimension 1329, 5. Bit patterns: AB86, AB61, AB83, AB72 K1S, AB72R K1D.

Key 3: Dimension OV, 5. Bit patterns: AB4 003, AB5 001, AB6 004. Brand: GEGE.

Key 4: Dimension 54, 5. Bit pattern: AB7.



7

PER / FOR

ABUS (D)

- ANCHOR
- BRICARD
- BUFFO
- CISA
- GEGE
- JET
- JPM
- KALE
- + G.R. (90)
- + GUARD (90-91)
- + PFAFFENHAIN (141)
- + YALE (194)

PER:
FOR:

ABUS

Key 1: Dimensions A, 759, 5. Bit patterns: AB14, AB14R. Code: 1-2-3-4-5. Brand: ANCHOR - JET - JPM - KALE.

Key 2: Dimension 255, 6. Bit pattern: AB9.

Key 3: Dimensions 595, 714, 5. Bit pattern: AB19. Code: 1-2-3-4-5-6.

Key 4: Dimensions 11, 326, 568, 3588, 5. Bit patterns: AB3, AB3R. Code: 1-2-3-4-5-6. A: 1-01321. Brand: CISA.

PER:
FOR:

ABUS

Key 1: Dimensions 11, 326, 500, 4. Bit patterns: AB2, AB2R. Code: ... 1-342. EE: ... 1-800. 1-2-3-4-5-6. B: ... 1-342. E: ... 801-1236. EF: ... 1-724. ER: ... 801-1236. Brand: BUFFO - CISA.

Key 2: Dimensions 11, 4. Bit pattern: AB18.

Key 3: Dimensions 167, 4. Bit patterns: AB11, AB11R.

Key 4: Dimensions 2, 5. Bit pattern: AB20.



8

PER / FOR

ABUS (D)

- ANCHOR
- ARMSTRONG
- BASI
- BURG
- CISA
- FTH
- GUARD
- GUITTEL
- IMP
- MASTER
- ROYAL

- + G.R. (90)
- + GUARD (90-91)
- + PFAFFENHAIN (141)
- + YALE (194)

PER:
FOR:

ABUS

AB17 AB17R
... 1-2000
... 1-2-3-4-5

AB29R

AB12 AB12R
... 1-2-3-4-5

AB15 AB15R
... 1-60
... 1-60
...
... 1-2-3-4-5 1-2-3-4-5

AB23
... 1-24
... 65/25 1-2-3-4-5

AB13 AB13R
... 1-2-3-4-5
FTH

AB16 AB16R
... 1-200
... 1-2-3-4-5

AB23R

ANCHOR - IMP

ANCHOR - BURG
GUITTEL - IMP - ROYAL

CISA

BASI - GUARD

PER:
FOR:

ABUS

AB81

AB27
... 1-2-3-4-5-6
mm 50-60

AB30 AB30R

AB31

PER:
FOR:

ABUS

AB35 AB35R

AB39 AB39R

AB41R

AB43 AB43R

AB45

MASTER

ARMSTRONG

PER:
FOR:

ABUS

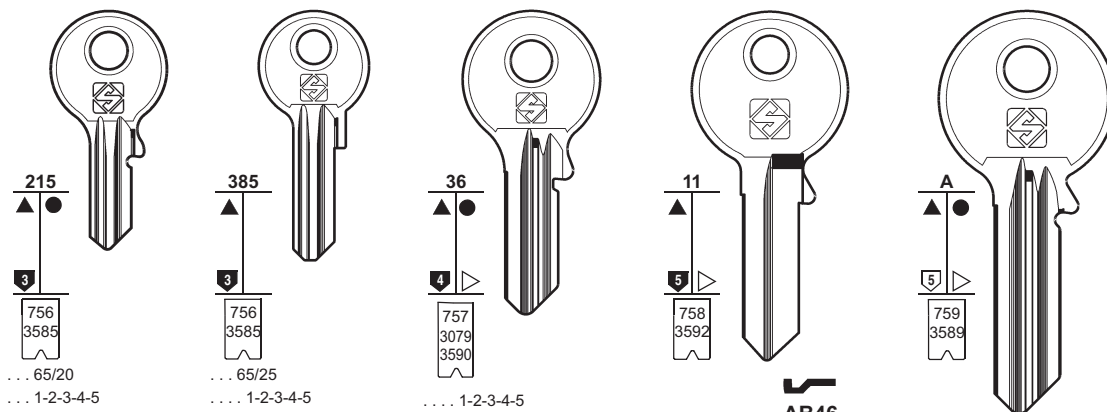

AB50

AB51

AB53

AB52
..... 1-2-3-4-5
..... 1-2-3-4-5-6

AB71

AB54
..... 1-2-3-4-5



9

PER / FOR

- ABUS (D)**
BUFFO
FORT
SECURITAL
 + G.R. (90)
 + GUARD (90-91)
 + PFAFFENHAIN (141)
 + YALE (194)

PER:
FOR:

ABUS

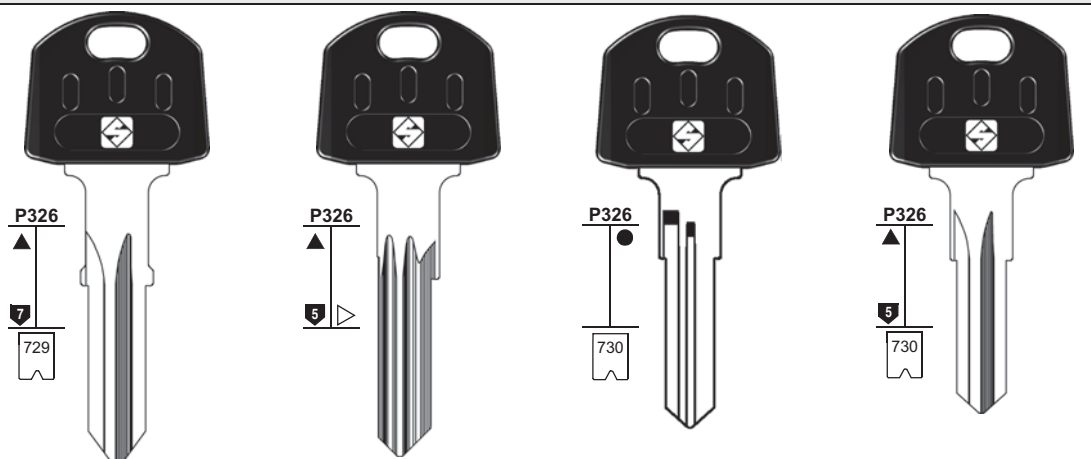

AB57AP **AB57RAP**
Z71 ... 1-1043 Z71 ... 1-1043
Z72 ... 1-1043 Z72 ... 1-1043

AB56AP
SL ...
1-2515

U72 **AB64RAP**
F82 V62 ... 1-331
X61 ... 1-331
X62 ... 1-331

AB65RAP W71

AB58RAP **AB59RAP**
X61 ... 1-331 V61 ... 1-331
X62 ... 1-331
V62 ... 1-331



BUFFO



PER:
FOR:

ABUS

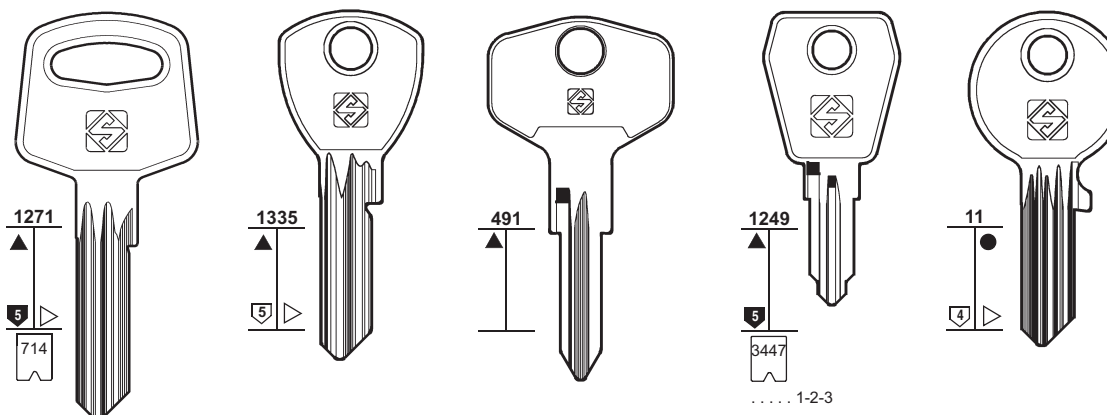

AB56 **AB56R**
SR ... SL ...
1-2515 1-2515

AB76 **AB76R**

AB93R

AB90R
FG

AB85
AL



FORT - SECURITAL



10

PER / FOR

ABUS (D)
 CISA
 BRICARD
 + G.R. (90)
 + GUARD (90-91)
 + PFAFFENHAIN (141)
 + YALE (194)

ACE (USA)
 CHICAGO (46)

ADAMS RITE (USA)

ADEMCO (USA)
 CHICAGO (46)

ADS (D)

AEP (LV)

AGA (E)
 ARREGUI
 BTV
 MECALUX
 SUYOKA
 + CHICAGO (46)

PER:
FOR:

ABUS

AB66R
 48/49
 1205-9533
 1717-9020

AB91

AB74
 D6
 00001-38832
 0001-4800
 (XN005710)1-38832
 000001-168000

AB84
 EC550
 SM
 00001-30000

AB77
 D8

AB48
 D6
 00001-38832
 0001-4800
 (XN005710)1-38832
 000001-168000

NEW ASTRAL

PER:
FOR:

ABUS

ADAMS RITE

ADS

AB40
 AAL
 EXTRA-CLASSE
 00001-50252

AB62
 EC75
 00001-10000
 D8 0001-8000

ADT1

AD1

AD2

CISA - BRICARD

mm 30-40-50

PER:
FOR:

AEP

AGA

AEP1

AEP2

AGA1
 B... 901-926

AGA1R
 A... 901-926

AGA2
 D... 901-926

AGA2R
 C... 901-926

AGA4
 G... 501-526
 G... 901-926

AGA4R
 H... 501-526
 H... 901-926

AGA5
 E... 501-526
 E... 901-926

AGA5R
 F... 501-526
 F... 901-926

AGA3

AGA25

AGA25R

BTV - MECALUX SUYOKA

ARREGUI

PER:
FOR:

AGA

54
477
1197
1197

S177
S842
S897
S898
S971
S972
S971
S1020

S841
S895
S896

AGA6 AGA8 AGA7 AGA9

GARI COLOMENCA - FB CASAS

SERRALLER - TERCA

AGB

599

U C

583

AGB1 AGB1R

SAVIO

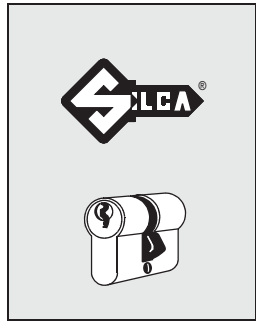

11

PER / FOR

AGA (E)
CASAS
COLOMENCA
FB
GARI
SERRALLER
TERCA
+ CHICAGO (46)

PER:
FOR:

AGB

599 600 600 1275

U C U C U C U C

4 5 4 4

S171
S534

..... 0/9
..... A/Z

AGB2 AGB2R AGB3 AGB3R AGB4 AGB5

SAVIO SAVIO SCUDO 9000

AGB (I)
SAVIO

PER:
FOR:

AGB

1434 1434 1434 1434

C C C C

7 6 7 6

S633 S647
S1330
S1409
S1440 S633 S647
S1330
S1409
S1440

..... 0/9
..... A/Z

AGB8 AGB9 AGB6 AGB7

SCUDO 7000 SCUDO 5000

SCUDO



12

PER / FOR

AGE (J)

AGENT (J)

AGUIA (P)

AISPUTE (LV)
KURZEMES

AKIRA (I)

YETI (198-199)

AKKA (I)

WALLY (188)

PER:
FOR:

AGE

AGENT

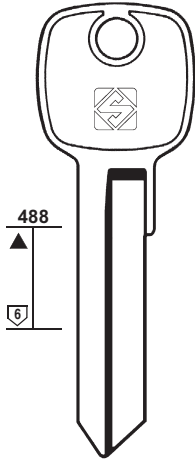

AGE5R

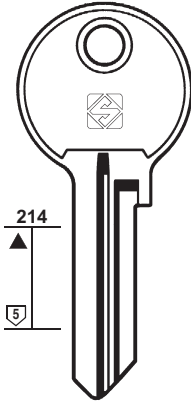

AGE2

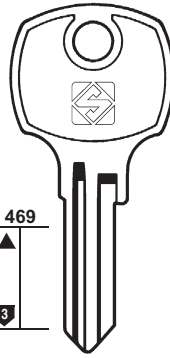

AGE3

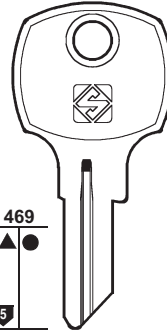

AGE1 AGE1R

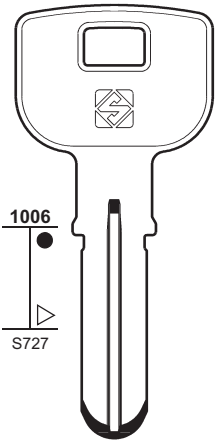

AGN1



PER:
FOR:

AGUIA

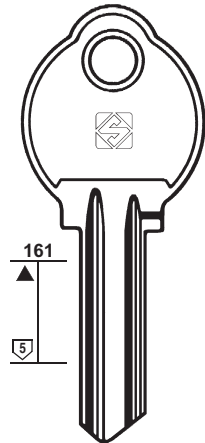

AG1 AG1R

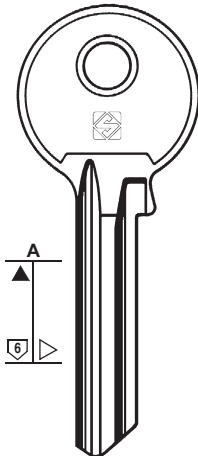

AG4 AG4R

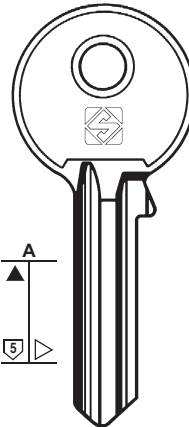

AG2 AG2R

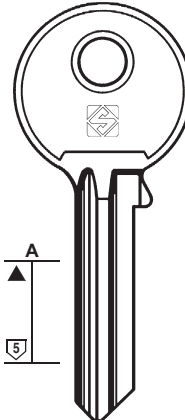

AG3 AG3R

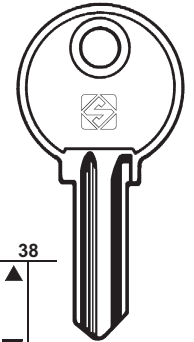

AG5 AG5R

AG7

AG7R

AG6

AG6R

PER:
FOR:

AGUIA

AISPUTE

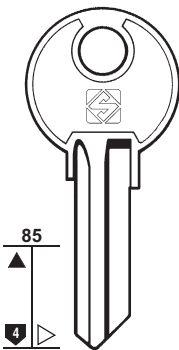

AG8 AG8R

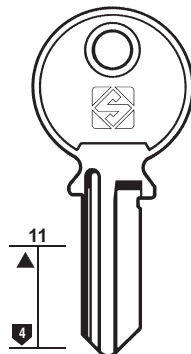

AG9 AG9R

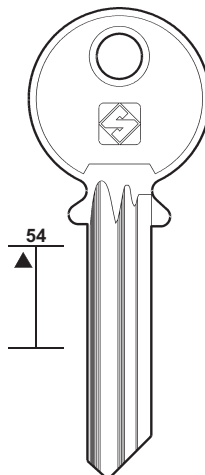

AG10

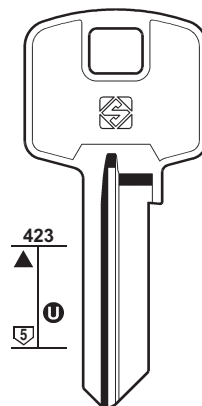

ASU1R

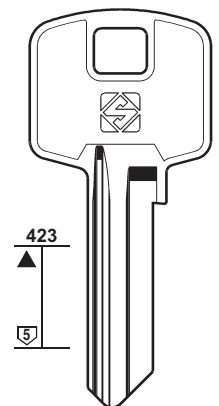

ASU2

KURZEMES

PER: FOR:	AL	AL AHRAM	ALA	
	 ● AL1 ▲ AL1R	 AHR2 	 AA6 ● AA6R mm 70	 AA5 ● AA5R mm 60

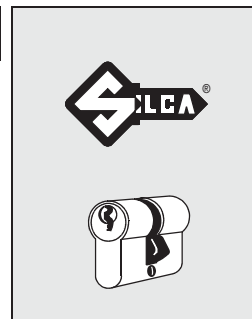

13

PER / FOR
AL (P)
AL AHRAM (ET)
ALA (I)
 CISA
 + CISA (50)
 + KESO (105)
ALDRIDGE E. (GB)
 ASEC SECURITY

PER: FOR:	ALA				
	 AA1 AA1R mm 50	 AA2 AA2R mm 40	 AA3 ... 1-2-3-4-5-6-7 mm 30	 AA4 AA4R 	 CS12 CISA mm 15

PER: FOR:	ALDRIDGE E.		
	 AE1R 	 AE2R 	 ASEC1 ... 1-2-3-4-5-6

ASEC SECURITY



14

PER / FOR

ALDRIDGE E. (GB)
ASEC SECURITY

ALF (F)
CISA (48)

ALFA (S)

ALI (RC)
CINA (48)

ALIANÇA (BR)

ALKE (I)

ALLGOOD (GB)
CENTURY (41)

ALMET (USA)
ARROW (18)

ALPHA (I)
+ CHICAGO (46)

PER: ALDRIDGE E.
FOR:

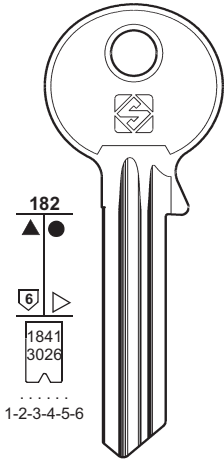

ASEC SECURITY

ALFA

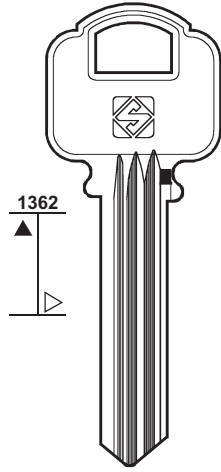

ALA1R



ALA2R

ALIANÇA

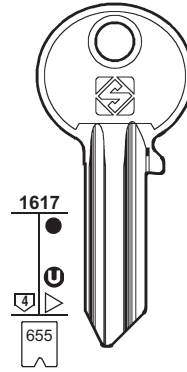

AI1

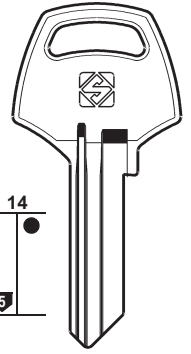

AI2

PER: ALKE
FOR:

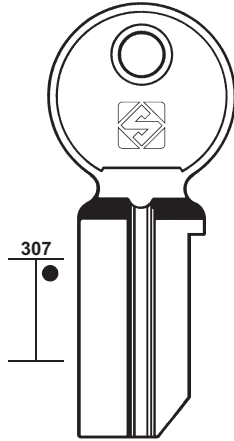

ALK1

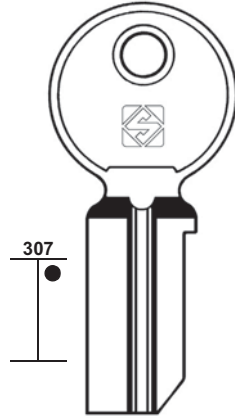

ALK2



ALPHA

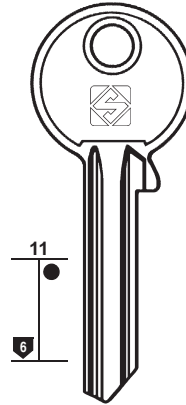

ALP2

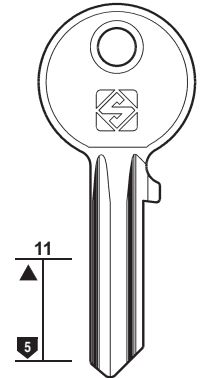

ALP11

PER: ALPHA
FOR:

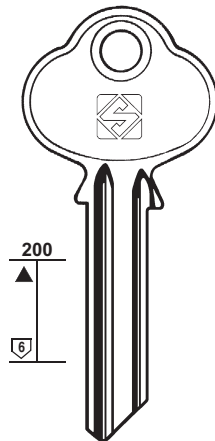

ALP3

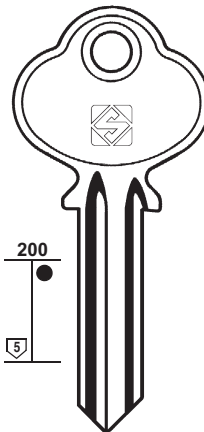

ALP10

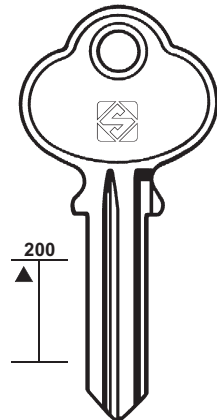

ALP1

PER:
FOR:

ALPHA

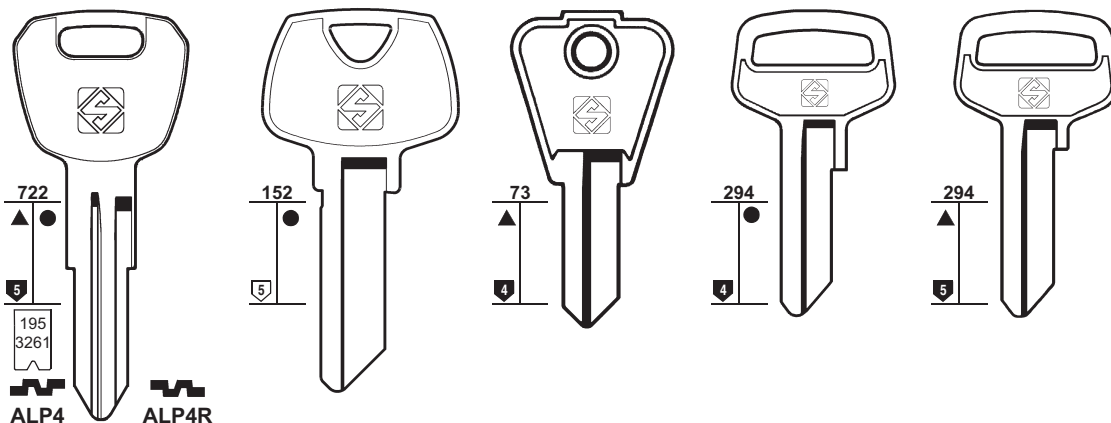

ALP4 ALP4R

S... 301-600



ALP9
7000...

ALP9R
LINCE
JD

ALP6R



ALP5R



ALP8R



ALP7R



MONACOR - SANY - VISONIC



HMP



HMP



HMP



15

PER / FOR

ALPHA (I)
 FEB
 HMP
 JD
 LINCE
 MONACOR
 SANY
 VISONIC
 + CHICAGO (46)

ALSO (USA)
 JUNKUNC (101)
 STS (162)

ALUBOX (I)

ALUNORM (I)
 CORBIN (53)

AM (I)
 POTENT (142)

AMARO LIMITADA (P)
 PICARDIE

AMELCO (BR)

AMERICAN (USA)
 JUNKUNC (101)

AMEROCK (USA)
 ARROW (18)

PER:
FOR:

ALPHA

ALUBOX

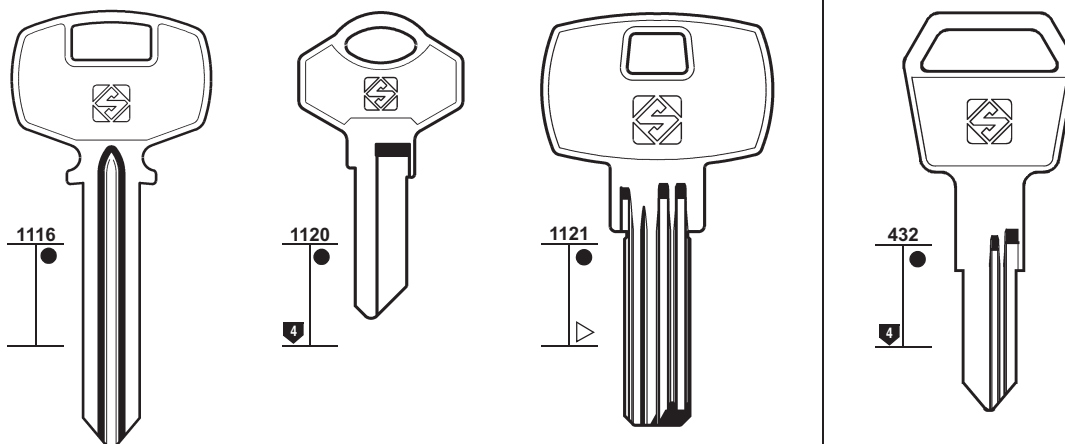

ALP12

ALP14R

ALP16

ALU1



PER:
FOR:

AMARO LIMITADA

AMELCO

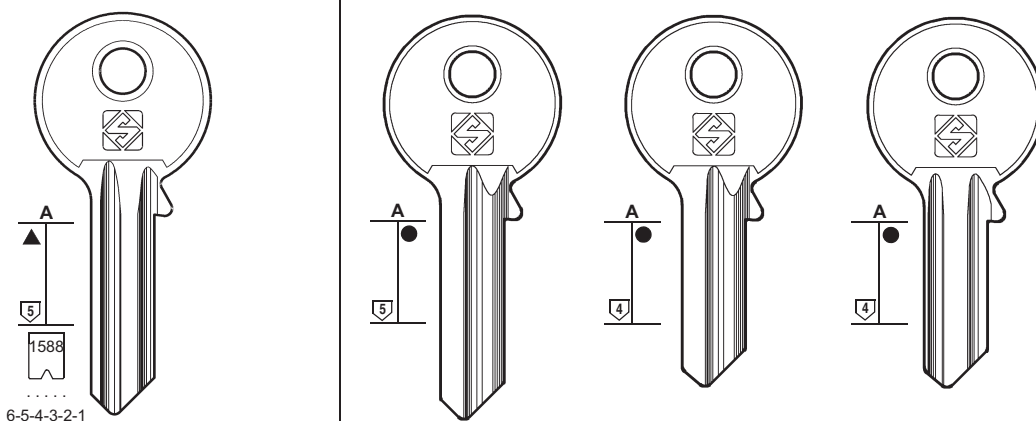

ALM1

ALM1R

AMC2R

AMC1R

AMC3

PICARDIE



16

PER / FOR

AMIG (E)

ANCHOR (S)
ANKERSLOT
+ ABUS (7-8)

ANHSIN (HK)

ANKERSLOT (NL)
ANCHOR
LITTO
ODA
+ ANCHOR (16)
+ LITTO (113)

PER:
FOR: **AMIG**

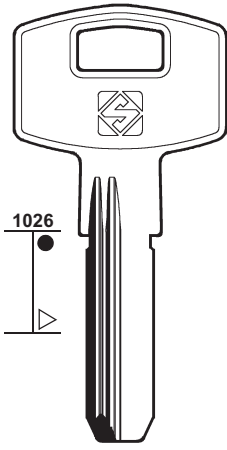

AMG1R



ANCHOR

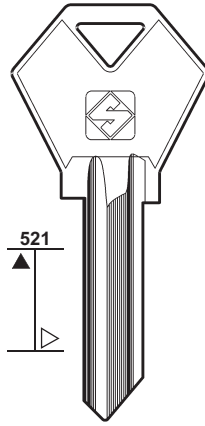

ACR1

ANKERSLOT

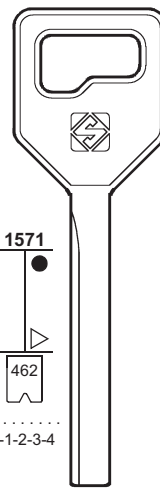

ACR3

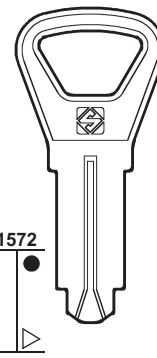

ACR4



ANHSIN

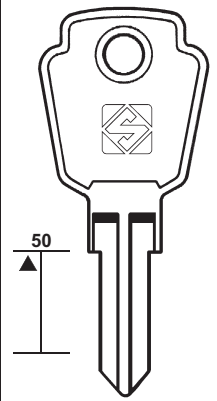

AH1

PER:
FOR:

ANKERSLOT

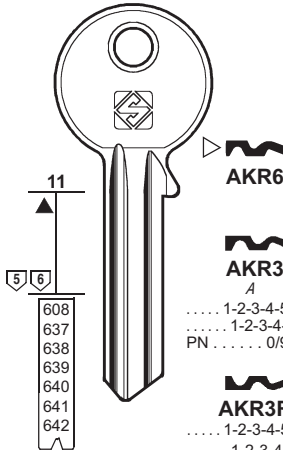

AKR6

AKR3

A
..... 1-2-3-4-5-6-7
..... 1-2-3-4-5-6-7
PN 0/9 1-2-3-4-5-6-7

AKR3R

..... 1-2-3-4-5-6-7
..... 1-2-3-4-5-6-7
... L ... 1234567RSTUVWX

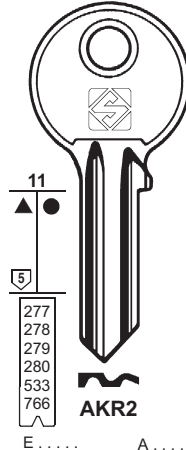
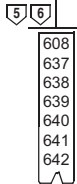

AKR2

277
278
279
280
533
766

E
F
K
G
1-2-3-4-5-6-7

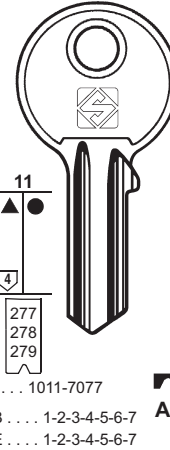

AKR1

A

277
278
279

..... 1011-7077
B 1-2-3-4-5-6-7
E 1-2-3-4-5-6-7
F 1-2-3-4-5-6-7
K 1011-7077
V 1-2-3-4-5-6-7
K ... 111-888

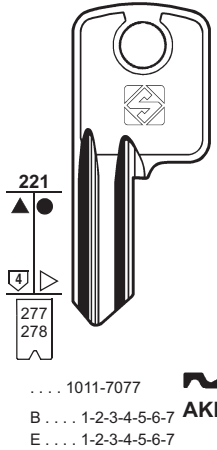

AKR7

277
278

..... 1011-7077
B 1-2-3-4-5-6-7
E 1-2-3-4-5-6-7
F 1-2-3-4-5-6-7
K 1011-7077
K ... 111-888



PER:
FOR:

ANKERSLOT

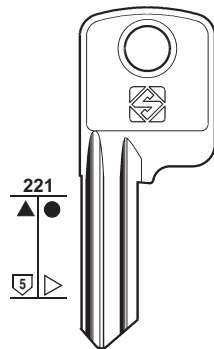

AKR10

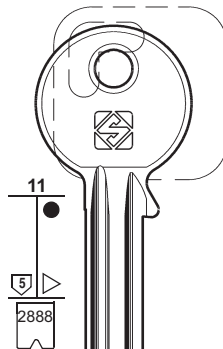

AKR15

PK
1-2-3-4-5-6-7

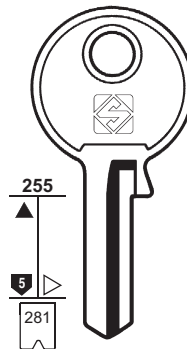

AKR5

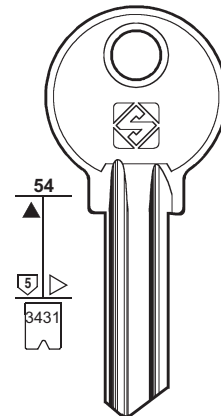

AKR4

.....
A111-GO777

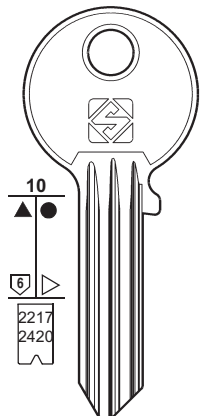

AKR8

..... 1-2-3-4-5-6-7-8-9
N 1 1-28800

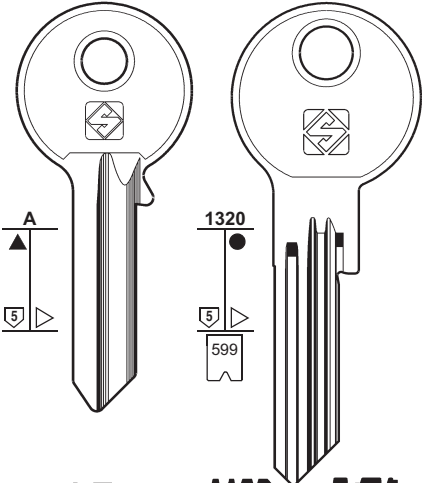
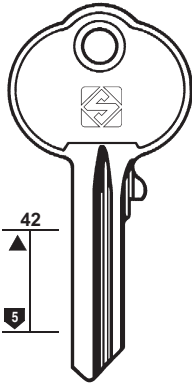
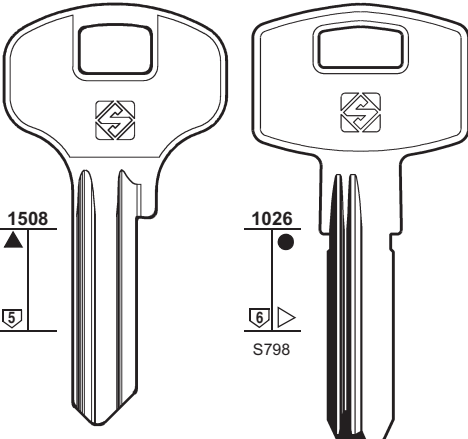
PER: FOR:	ANKERSLOT	ANTAR	APEKS	
	 <p>A 1320 599</p> <p>AKR9R AKR11R AKR14 V..... W..... X..... Z..... 1-65535</p>	 <p>42 5</p> <p>AN1 AN1R</p> <p>VEGA</p>	 <p>1508 5</p> <p>1026 S798</p> <p>APK1 APK2R</p>	



17

- PER / FOR**
- ANKERSLOT (NL)**
+ ANCHOR (16)
+ LITTO (113)
 - ANLO (F)**
+ GLOBE (87)
 - ANTAR (F)**
VEGA
+ RONIS (146-147)
 - APEKS (RUS)**
 - AQUILA (I)**
 - AREL (GB) (I)**
 - ARFE (E)**
STS
+ FORT (81)
+ STS (162)
 - ARMOR (F)**
+ RONIS (147)
 - ARMSTRONG (CZ)**
+ ABUS (8)
 - ARNOV (F)**
+ ZENITH (201)
 - AROUCA (BR)**

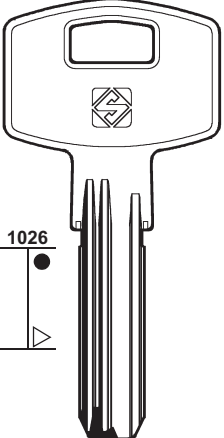
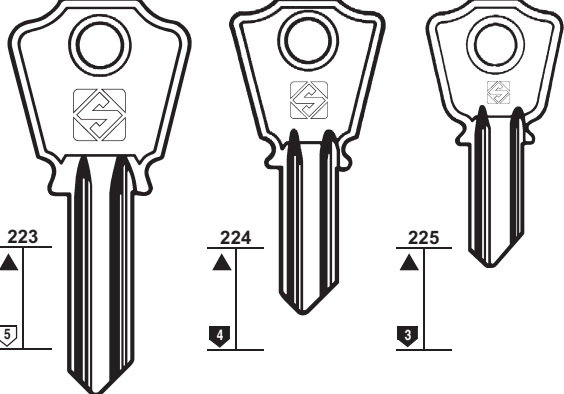
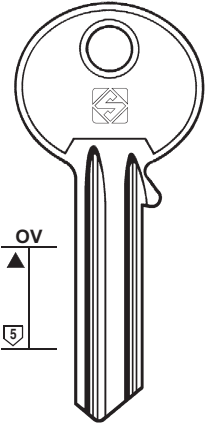
PER: FOR:	APEKS	AQUILA	AREL (GB)
	 <p>1026</p> <p>APK3R</p>	 <p>223 224 225</p> <p>5 4 3</p> <p>AQ1 AQ1R AQ3 AQ3R AQ4 AQ4R</p>	 <p>OV</p> <p>5</p> <p>ARE1</p>

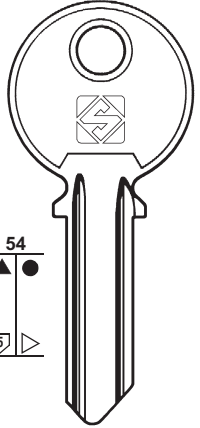
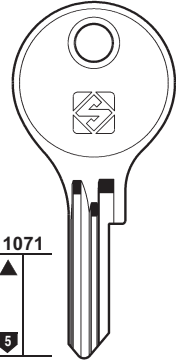
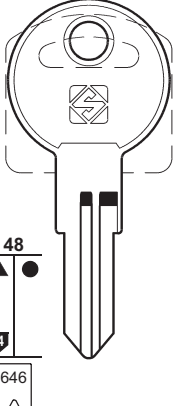
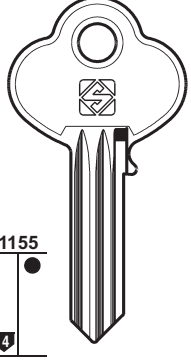
PER: FOR:	AREL (I)	ARFE	ARMSTRONG	AROUCA
	 <p>54</p> <p>5</p> <p>ARL1 ▲ ARL1R</p>	 <p>1071</p> <p>5</p> <p>ARF1</p> <p>STS</p>	 <p>48</p> <p>4</p> <p>646</p> <p>ART1 ART1R ... 101-801</p>	 <p>1155</p> <p>4</p> <p>646</p> <p>..... 1-2-3-4-5-6-7</p> <p>AUC1</p>



18

PER / FOR

AROUCA (BR)

ARREGUI (E)

AGA (10)

FAC (75)

ARROW (USA)

ALMET
AMEROCK
DOMINION
FORT
LG

ARSENJEVSK (RUS)

ASEC SECURITY (GB)

ALDRIDGE E. (13-14)

ASIA (RC)

TWIRHONB
+ YETI (198-199)

ASIAN (RC)

ASPA (NL)

+ DOM (63)

ASSA (S)

TEKA
+ RUKO (148)

PER:
FOR:

AROUCA

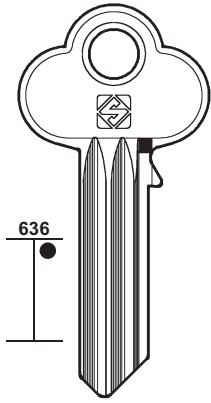

636



AUC4

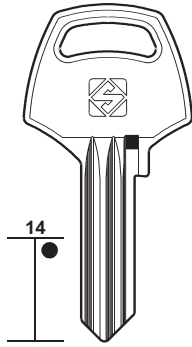

14



AUC5

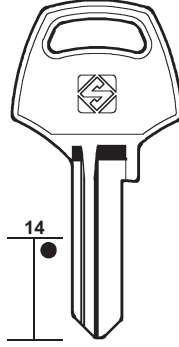

14



AUC6

ARROW

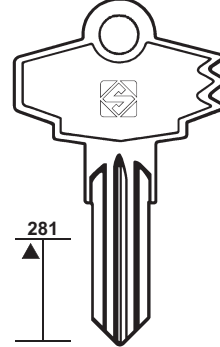

281



AW1



AW2

DOMINION - FORT - LG

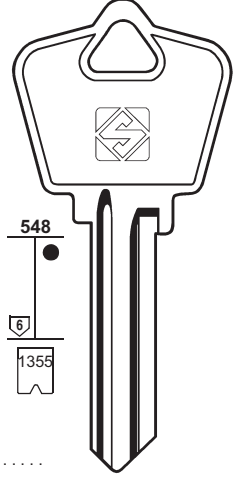

548

1355



AW3



AW4

.....
0-1-2-3-4-5-6-7-8-9



AW5
K7

AMEROCK

PER:
FOR:

ARROW

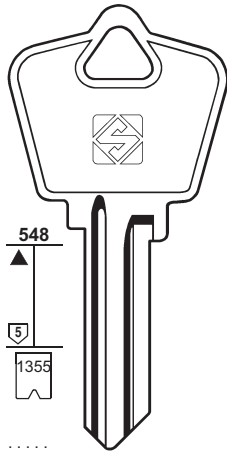

548

1355

.....
0-1-2-3-4-5-6-7-8-9



AW6

K7-5

ALMET

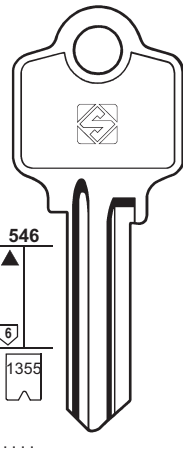

546

1355

.....
0-1-2-3-4-5-6-7-8-9



AW7

K2

ALMET

ARSENJEVSK

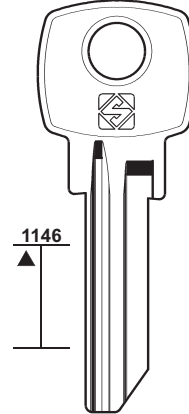

1146



ARS1

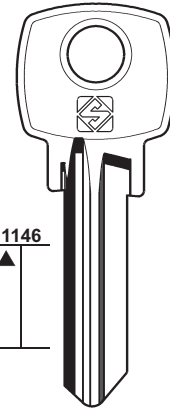

1146



ARS2

ASIA

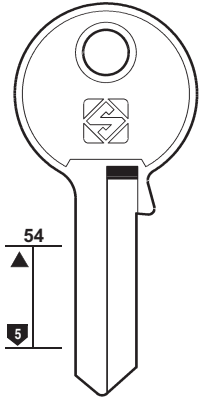

54

5



AS1

mm 45
TWIRHONB

PER:
FOR:

ASIAN

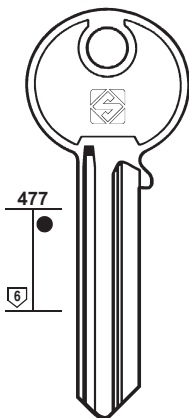

477

6



ASN1



ASPA

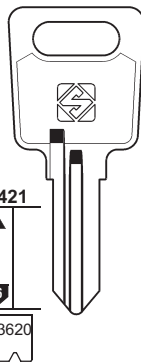

421

3620



APA1R
2U ... 1-748

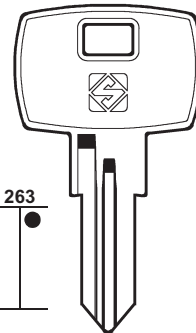

263



APA2R

ASSA

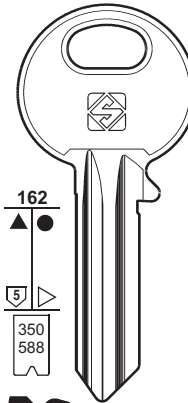

162

350
588

▲ ASS63
22001



ASS6

20201

..... 0-1-2-3-4-5-6-7-8-9-A-B-C

..... D-0-1-2-3-4-5-6-7-8-9-A-B-C



ASS6R

20301

..... 0-1-2-3-4-5-6-7-8-9-A-B-C

..... D-0-1-2-3-4-5-6-7-8-9-A-B-C

TEKA

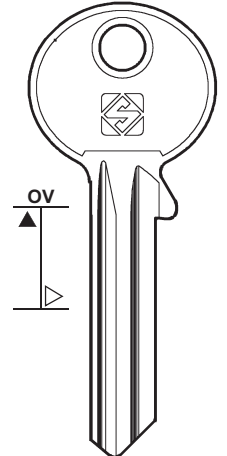

OV



ASS186

PER:
FOR:

ASSA

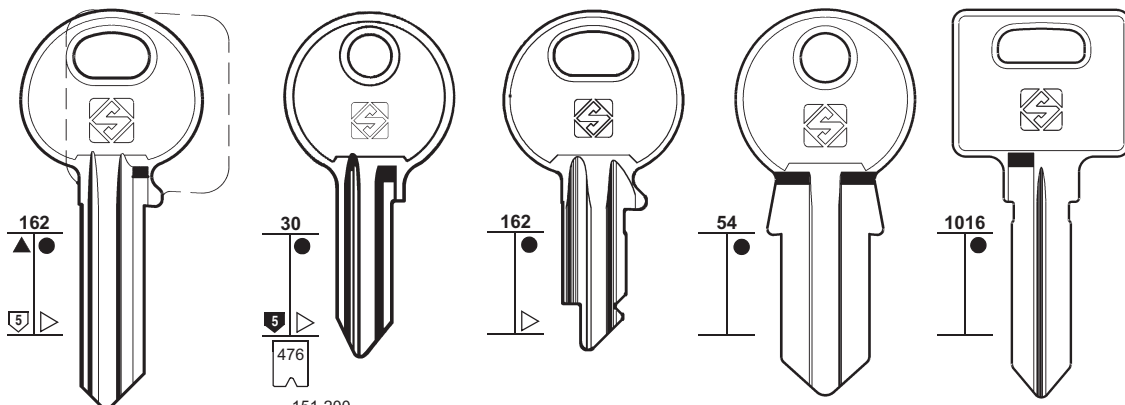

... 151-200
..... 0-1-2-3-4-5-6

ASS137
22401

ASS47
21202

ASS181

ASS149

ASS148



19

PER / FOR

ASSA (S)
+ RUKO (148)

PER:
FOR:

ASSA

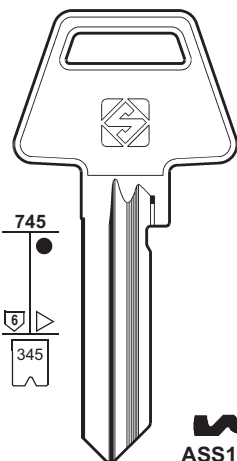

ASS122R
UM

ASS155
PK

ASS155R
UK

ASS142 TW
123456789
05-04

ASS143
05-05

ASS144 TW
123456789
05-13

ASS145
14-01

ASS146
14-09

ASS147
14-25

ASS150
11-08

ASS151
11-01

ASS152
11-32

ASS153
11-14

ASS154
11-12

ASS172
05-14

ASS174
14-33

ASS175R
UL

ASS176
TM

ASS177
TK

ASS178
TL

PER:
FOR:

ASSA

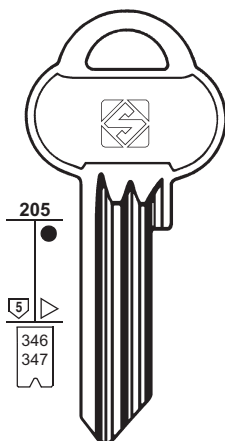

mm 28,7
560.

..... 1-2-3-4-5-6-7
..... 1-2-3-4-5-6-7-8

ASS9R

ASS9

ASS31R

ASS31

ASS11

ASS11R

ASS33

ASS33R

ASS2

ASS2R

ASS10R

ASS10



20

PER / FOR

ASSA (S)
+ RUKO (148)

PER:
FOR:

ASSA

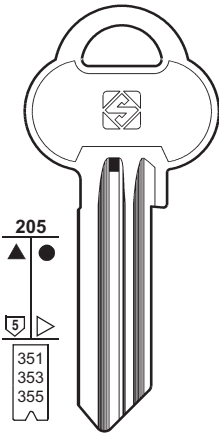

U ASS7

W ASS7R

D ASS64

H ● ASS64R

V ● ASS35R

T ● ASS35

RR ASS69

SS ▲ ASS69R

Z ▲ ASS37

X ASS37R

MM ASS68R

NN ASS44

PP ASS44R

FG ● ASS180R

5FG 10000-99809

. 1-2-3-4-5-6-7
. 1-2-3-4-5-6-7-8

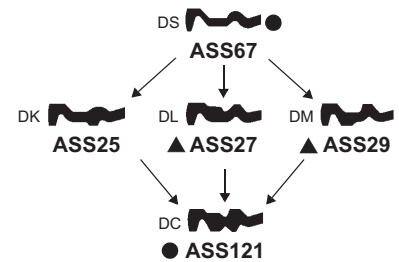
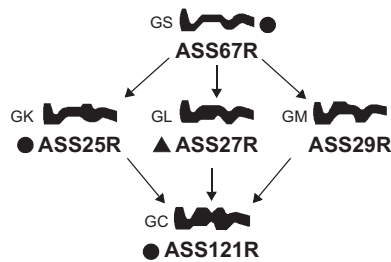
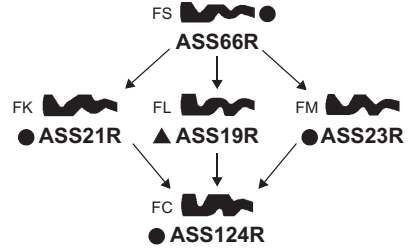
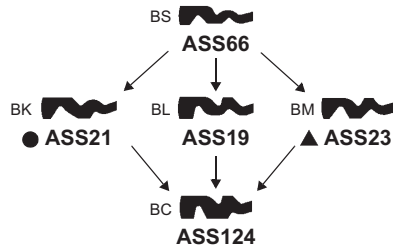
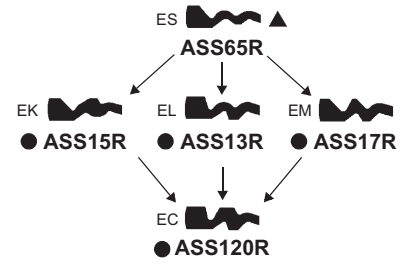
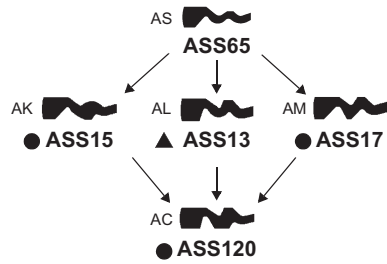

PER:
FOR:

ASSA



21

PER / FOR

ASSA (S)
+ RUKO (148)

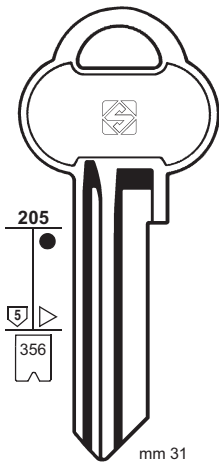

560.
..... 1-2-3-4-5-6-7

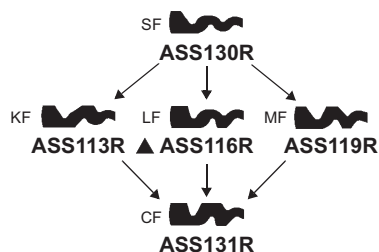
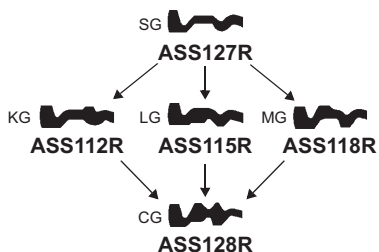
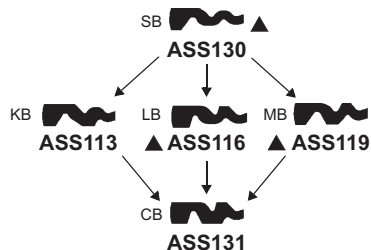
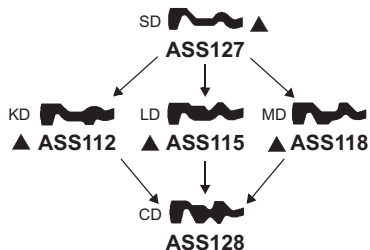
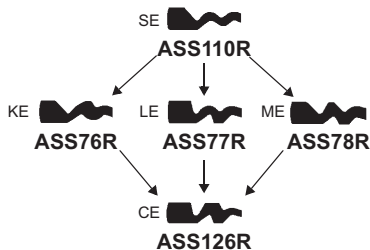
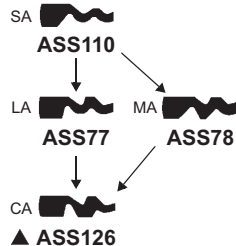

PER:
FOR:

ASSA

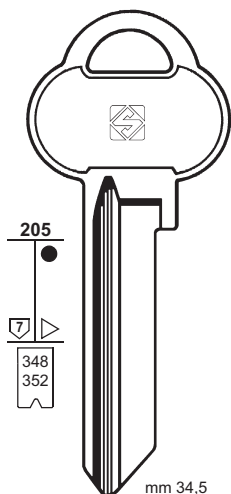

760.
..... 1-2-3-4-5-6-7

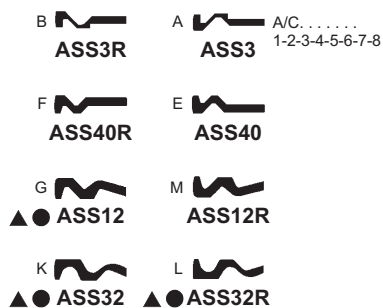



22

PER / FOR

ASSA (S)
+ RUKO (148)

PER:
FOR:

ASSA

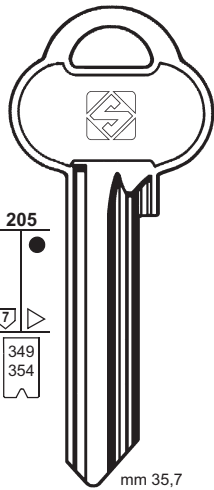

mm 35,7

760.

GG
ASS108

..... 1-2-3-4-5-6-7
..... 1-2-3-4-5-6-7-8

- | | | | | | |
|----|--|--------|----|--|--------|
| D | | ASS4 | H | | ASS4R |
| U | | ASS8 | W | | ASS8R |
| V | | ASS34R | T | | ASS34 |
| Z | | ASS36 | X | | ASS36R |
| NN | | ASS45 | PP | | ASS45R |
| RR | | ASS39 | SS | | ASS39R |
| KK | | ASS109 | MM | | ASS48R |

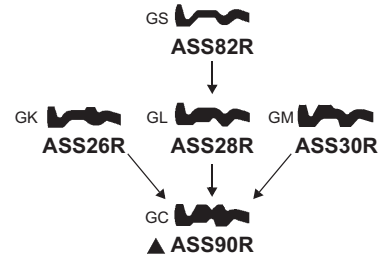
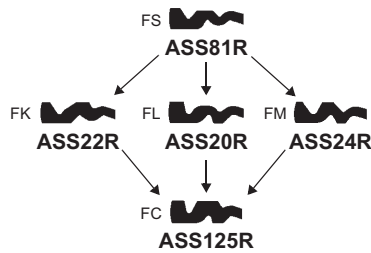
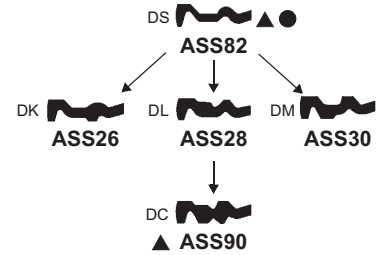
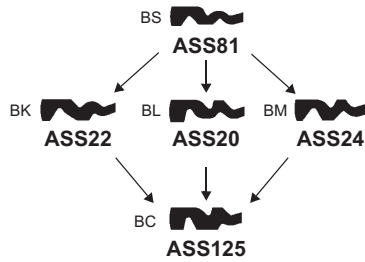
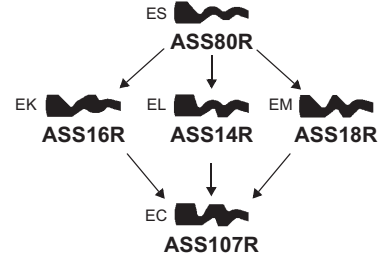
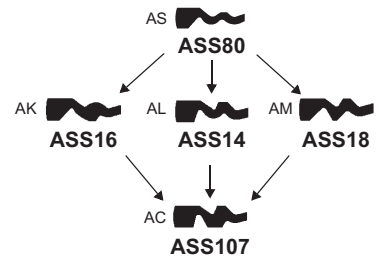

PER:
FOR:

ASSA



23

PER / FOR

ASSA (S)
+ RUKO (148)

ASTRA (AUS)

ATAL (F)
 KIFERM (106)
 LAS (110)
 L & F (116)
 RENZ (145)
 VACHETTE (181)

ATAY (RUS)

ATLAS (F)
 SUREX (163)

ATP (I)
 CITY (51)

AUBERT (F)
 ZENITH (201)

AUMON (E)

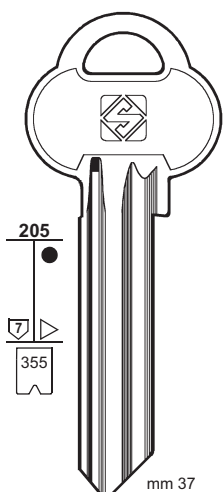

1DG 1-83499
0FG 10000-99809
0DG 1-99999
DS 1-78678
DJ 1-1234567
SE 00001-43800
..... 1-2-3-4-5-6-7
..... 1-78670

- | | |
|------------------|------------------------|
| DD ASS52 | HH ASS52R ▲ ● ⊕ |
| PA ASS102 | PB ASS102R |
| PD ASS183 | PE ASS183R |
| PF ASS103 | PG ASS103R |
| PH ASS104 | PN ASS104R |
| PR ASS105 | PT ASS105R |
| UU ASS94 | WW ASS94R |
| VV ASS51 | TT ASS51R |
| | XX ASS106R |

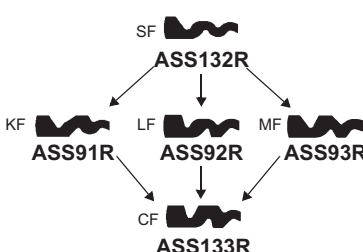
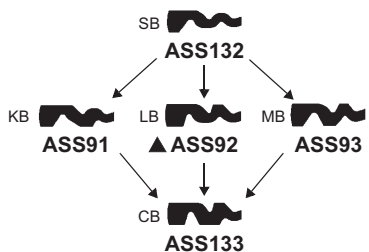
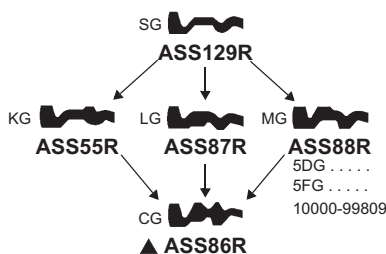
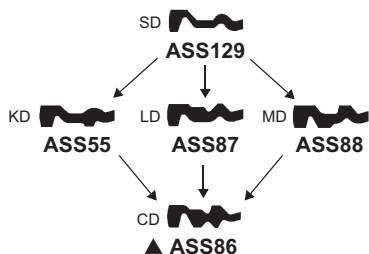
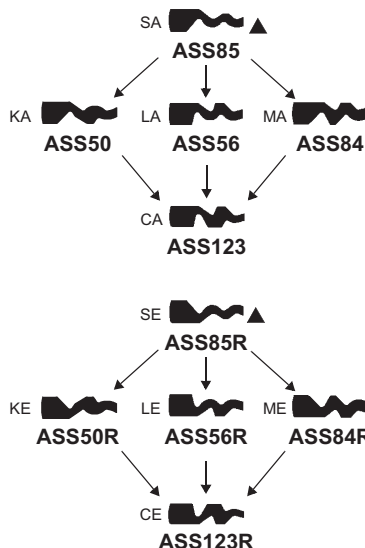

PER:
FOR:

ASTRA

ATAY

AUMON

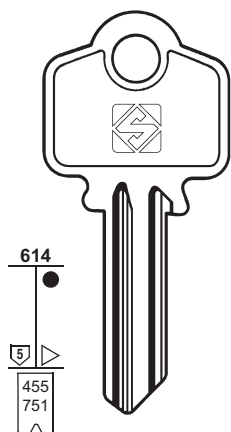

AT1
..... 0-1-2-3-4-5-6-7
..... 1-2-3-4-5-6-7-8

AT1R
..... 1-2-3-4-5-6-7-8

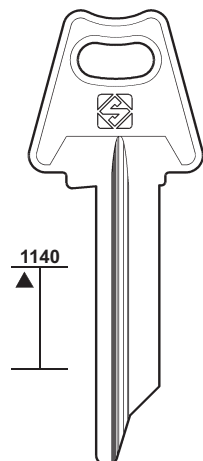

ATA1

ATA1R

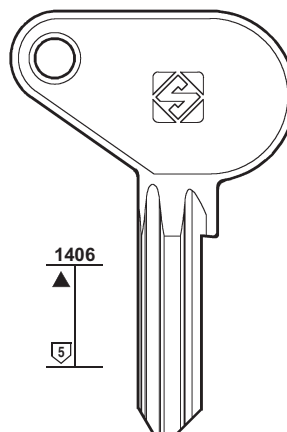

AUN1



24

PER / FOR

AUSTRAL LOCK (AUS)

AVA-CHUBB (S)

AVANGARD (RUS)

AVOCET (GB)
W.M.S.

AXA (NL)

AZBE (E)
CAVERS
+ TOK-WINKHAUS (171)

PER: AUSTRAL LOCK

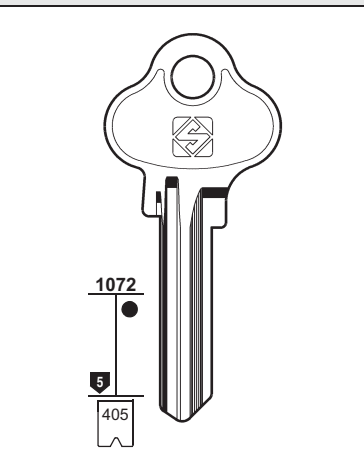

AUS1
..... 0-1-2-3-4-5-6-7-8-9-A

PER: AVA-CHUBB

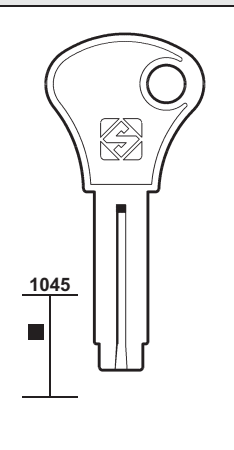

CHU7

PER: AVANGARD

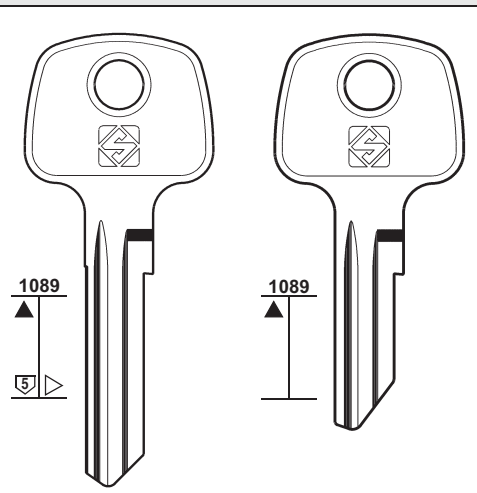

AV1 AV1R AV2

PER: AVOCET

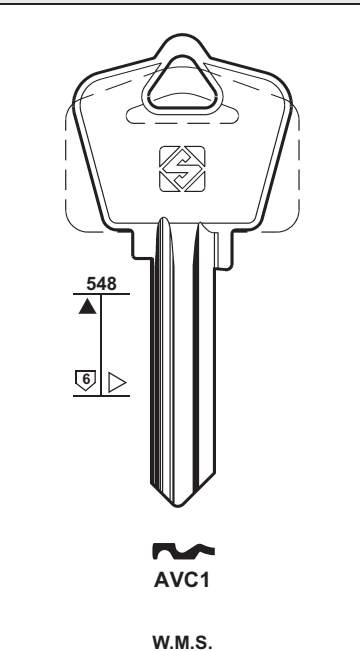

AVC1
W.M.S.

PER: AXA

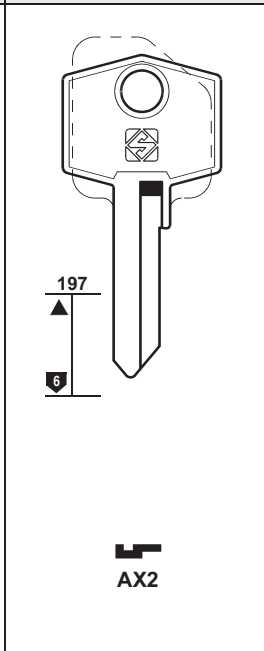

AX2

PER: AZBE

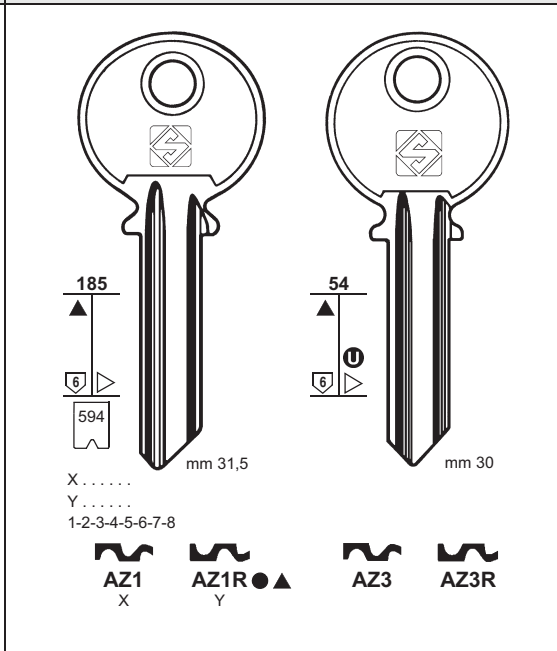

X
Y
1-2-3-4-5-6-7-8

AZ1 AZ1R AZ3 AZ3R

PER: AZBE

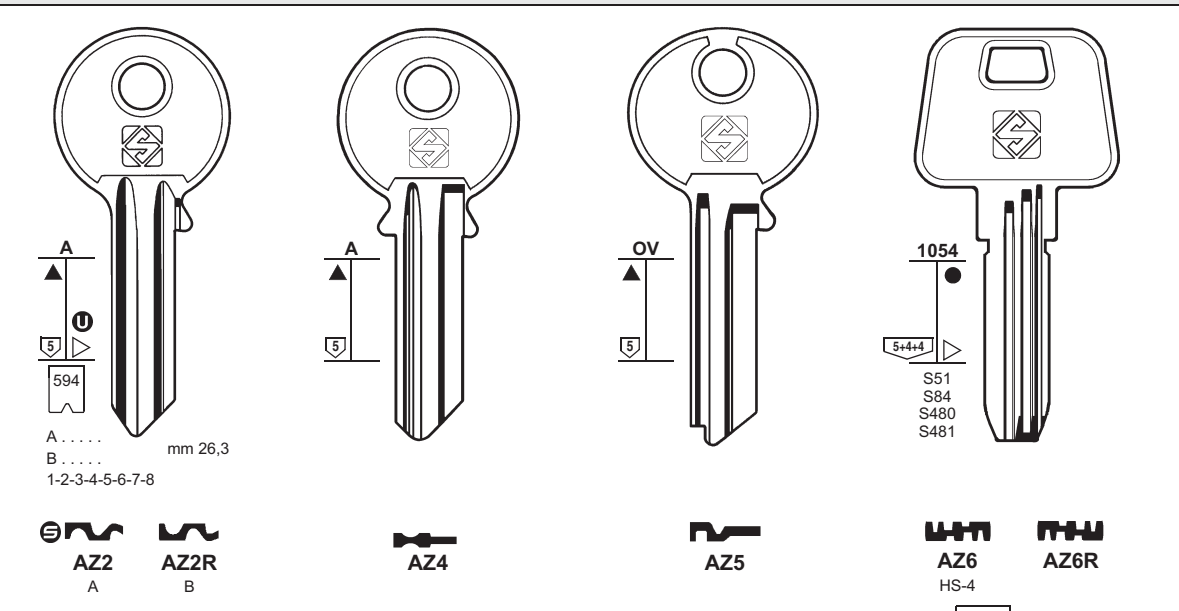

AZ2 AZ2R

AZ4

AZ5

AZ6 AZ6R



PER:
FOR:

AZBE

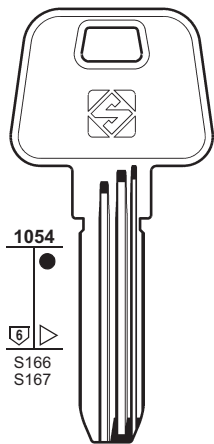

AZ7
HS-6

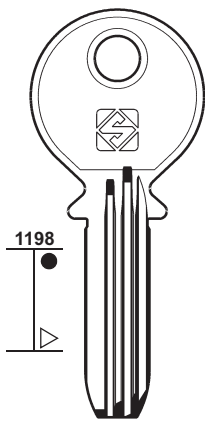

AZ8

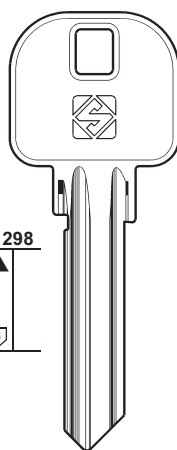

AZ9 **AZ9R**

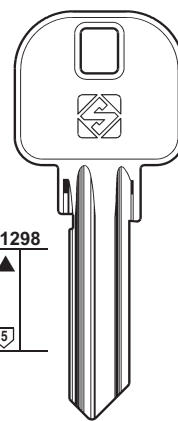

AZ10 **AZ10R**



25

PER / FOR

AZBE (E)
CAVERS
+ TOK-WINKHAUS (171)

AZMA (F)
VACHETTE (184)

BAAL (CH)
VÖGEL

BAB (D)
ESS

PER:
FOR:

BAAL

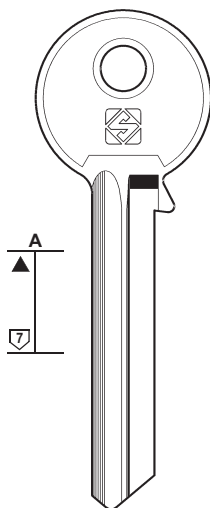

BAL7

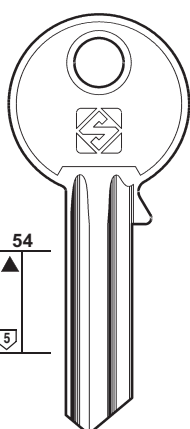

BAL5

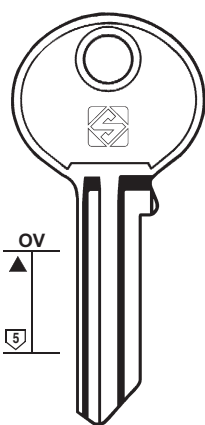

BAL1 **BAL1R**

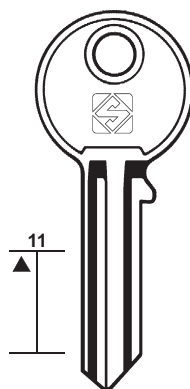

BAL2

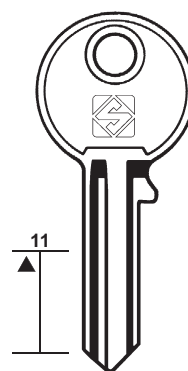

BAL3

VÖGEL

PER:
FOR:

BAAL

BAB

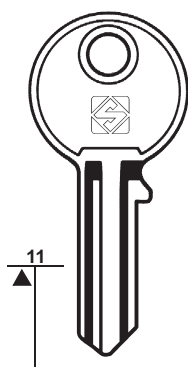

BAL4

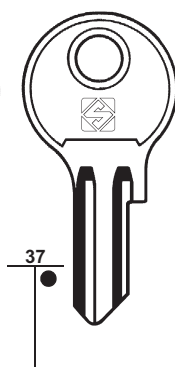

BAL6

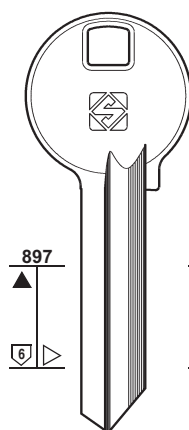

BAB6R

BAB7R

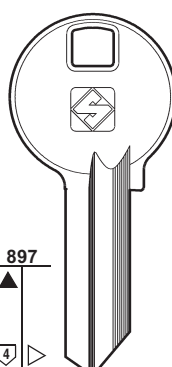

BAB4R

BAB5R

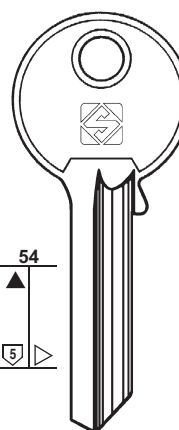

BAB2R

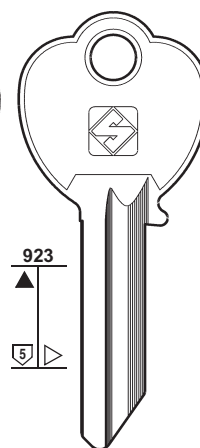

BAB18R

ESS



26

PER / FOR

BAB (D)
CORONA
HALLE
ZEISS-IKON

PER:
FOR:

BAB

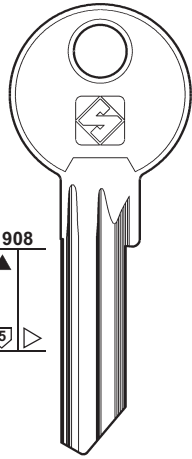

BAB14

ZEISS-IKON

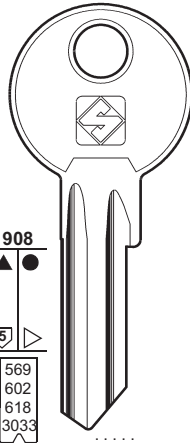

BAB13

CORONA - ZEISS-IKON

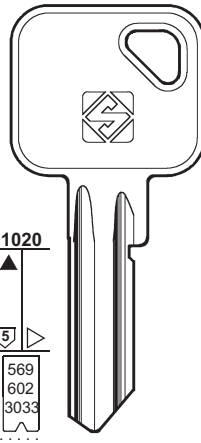

BAB13R

1-2-3-4-5-6-7-8-9-0
135679ACEGI

BAB25

1234567890ABCDEFGHIJL

1-2-3-4-5-6-7-8-9-0
135679ACEGI

BAB25R

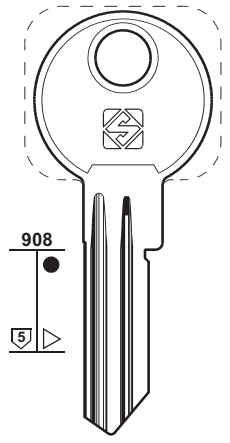

BAB27

BAB28R

BAB29

PER:
FOR:

BAB

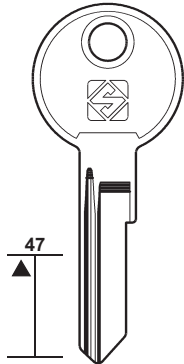

BAB15

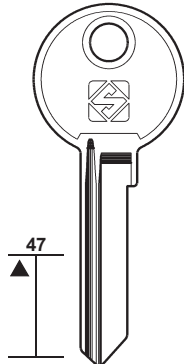

BAB16

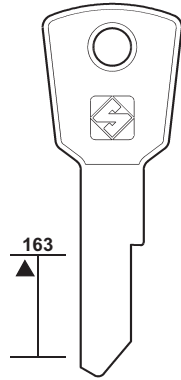

BAB19

HALLE

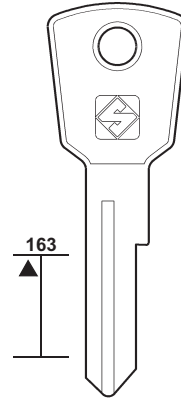

BAB20

HALLE

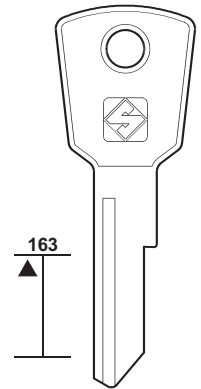

BAB21-3

BAB21-5

HALLE

BAB21-4

PER:
FOR:

BAB

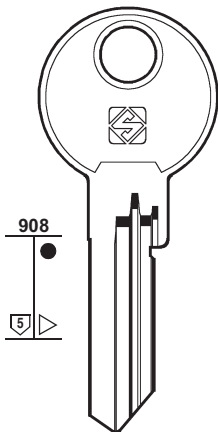

BAB26R-1

BAB26R-2

BAB26R-3

BAB26R-4

BAB26R-5

BAB26R-6

BAB26R-7

BAB26R-8

BAB26R-9

BAB26R-10

BAB26R-11

BAB26R-12







BAB26R-13

BAB26R-14

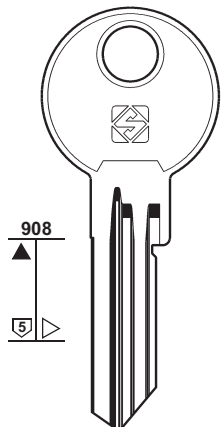
BAB26R-15

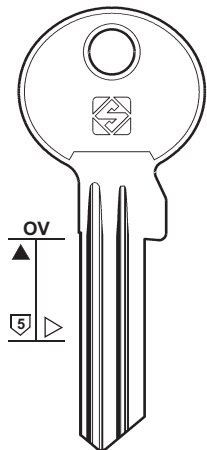
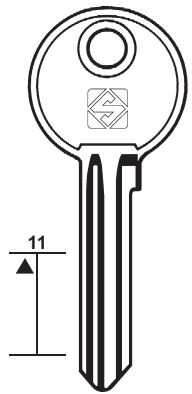
BAB26R-16



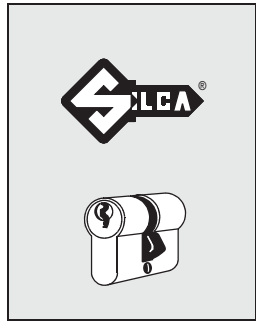

BAB26R-17



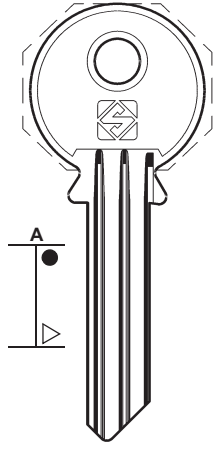
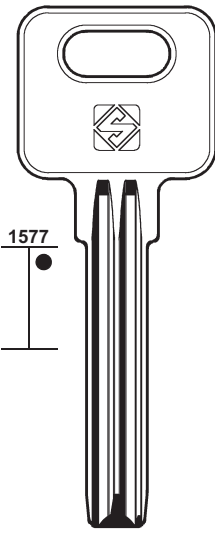
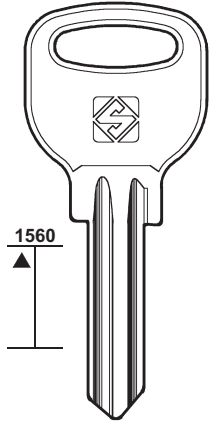

PER: FOR:	BAB		BABY CLIP
			
			<p>EFSA - ETF</p>

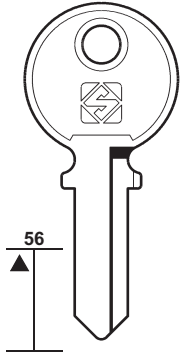
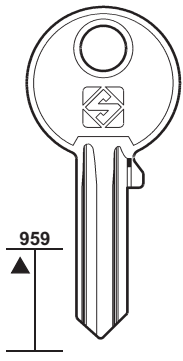
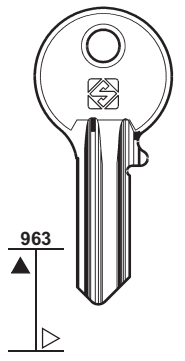
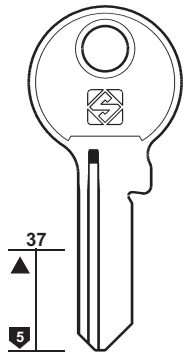
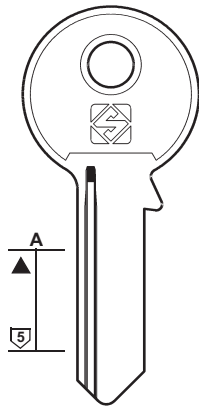

27

PER / FOR
BAB (D)
BABY CLIP (F) EFSA ETF
BAGEM (E) ABC (4)
BALDWIN (USA) SCHLAGE (151-152)
BALLY (I) TAMPALINI (164) ZANI (200)
BANE SEKULIĆ (SGC) BSS (36)
BANHAM (GB) SIDLEEN (154)
BANKA (I) GIUSSANI (87)
BAODEAN (PRC)
BAODELI (PRC)
BARAS (GR)
BARGMAN (USA) ILCO (96)
BARRO (D) DOM (61)
BASI (D) + ABUS (8) + BUGA (36) + CISA (50-51) + EURO-LOCKS (71) + L & F (117)

PER: FOR:	BANHAM		BAODEAN		BAODELI
					

PER: FOR:	BARAS	BASI					
							



28

PER / FOR

- BASI (D)**
- CIC
- + ABUS (8)
- + BUGA (36)
- + CISA (50-51)
- + EURO-LOCKS (71)
- + L & F (117)

BASCO (USA)
BIZERBA
ELMO

BASSI (I)

BASTA (IRL)

BASTA (DK)
EURO LOCKS

BATON (RC)

PER:
FOR:

BASI

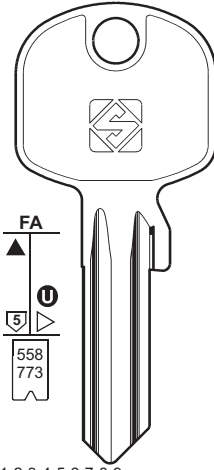

FA
5
558
773



BAI1

..... 1-2-3-4-5-6-7-8-9
..... 1-2-3-4-5-6-7-8-9-0
..... 800001-803640

CIC

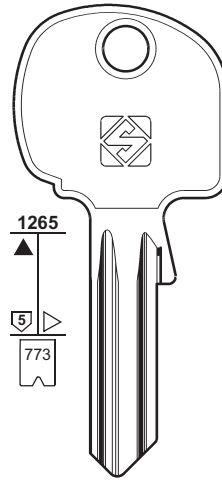

1265
5
773



BAI7

..... 1-2-3-4-5-6-7-8-9-0
..... 800001-803640

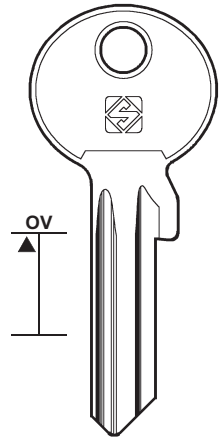

OV



BAI23

PER:
FOR:

BASCO

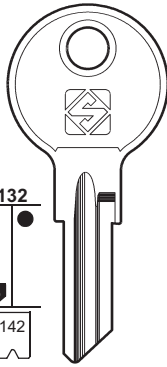

132
5
142



BA1



BA8

BA8R
C 1701-1950
C 1951-2200
C 250-499
C 500-699

ELMO

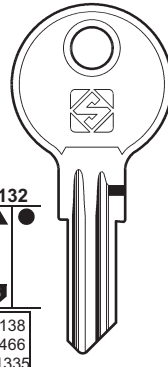

132
5
138
466
1335



BA5

..... 101-350
AN 1-500
HC 0-499
LL 1-326
LL 1-200
LL 1-200
DD 1-250
GC 101-150
CH 751-1178
RC 501-750

BIZERBA - ELMO



BA5R

..... CH 501-750
EM 501-750

BASSI

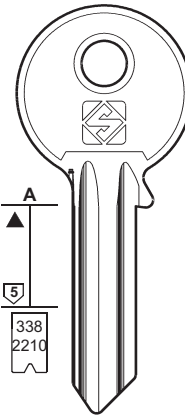

A
5
338
2210



TP1

..... 0-1-2-3-4-5
..... 1-2-3-4-5

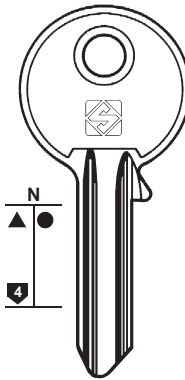

N
4



BSI2R

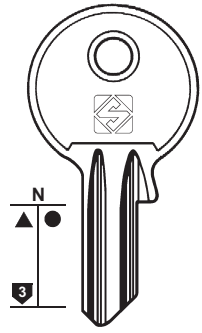

N
3



BSI1



BSI4



BSI4R



BSI1R

PER:
FOR:

BASTA (IRL)

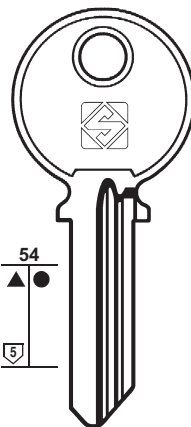

54
5



BAS1

BASTA (DK)

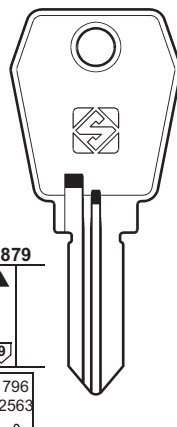

879
9
796
2563



BAS4R

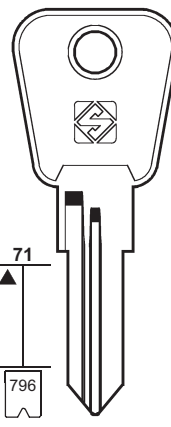

71
796



BAS5R

C 1-1000

M 1-1000
V 1-1000
W 1-1000
C 1-1000

EURO LOCKS

Copyright by Silca S.p.A. 2013 - All rights reserved

BATON

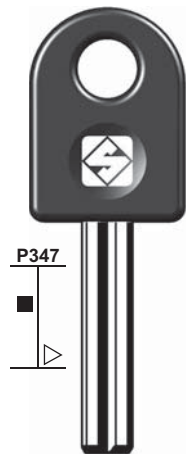

P347



BAT1P



PER: FOR:	BATON	BECCARINI	BELLEVILLE	BELL	
	 BAT2	 BN2 BN2R	 BLV3	 BLL1 BLL3	

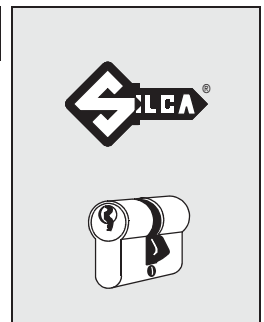

29

PER / FOR
BATON (RC)
BATU (E)
 👁 CISA (50)
 👁 IFAM (95)
BECCARINI (I)

BEDI (F)
 👁 YETI (198-199)

BELLEVILLE (USA)

BELL (RC)
 + 👁 YETI (198-199)

BENCO (NL)
 👁 YETI (199)

BENDIX (USA)
 👁 YALE (194)

BERAM (RC)
 👁 VIRO (187)

BERETTA (I)
 👁 FASEM (77)

BERRY (D)
 👁 BKS (30)
 👁 CES (42)

BERTO (CH)

BERTOLOTTI (I)
 👁 TICINO (166)

BEST (USA)
 FALCON

BETA (I)
 PICARD
 + 👁 CORNI (55)

BEY (TR)

BIB (I)
 👁 MERONI (123)

BIBERING (D)
 👁 TAS (165)

PER: FOR:	BERTO	BEST	BETA	
	 BRT1	BES1 0-1-2-3-4-5-7-8-9 0-1-2-3-4-5 0-1-2-3-4-5-6-7-8-9 BES2 BES3 BES4 BES5 BES6 BES7 BES8 BES9 BES10 BES11 BES12 BES18	BE202 BE203 1-2-3-4-5-6 BE200 BE201 1-2-3-4-5-6	
		FALCON	PICARD	

PER: FOR:	BETA			BEY	
	 BE4R 1-2-3-4-5-6	 BE3	 BE1 BE1R	 BEY1R	 BEY2R



30

PER / FOR

BIELLE (I)
FASEM
OMIV
P.C.

BIFFAR (D)
TOK-WINKHAUS (171)

BILMA (E)

BIGLA (CH)

BIRD (HK)
YALE (193)

BIZERBA (HK)
BASCO (28)

BKS (D)
BERRY
DAMM
GEBÄ
HÄFELE
HÖHRMANN
YALE
+ LITTO (113)
+ YALE (193-194)

PER: FOR:	BIELLE	BILMA	BIGLA
	FASEM - OMIV - P.C.	S344 1-2-3-4-5-6 S1290 X-1-3-4-5-6	

PER:
FOR:

BKS

Serie O
BERRY - DAMM - GEBÄ - HÖHRMANN - YALE

..... PZ 0211
1234567890ABCDEFGHIJL

PER:
FOR:

BKS

HÄFELE

PER:
FOR:

BKS

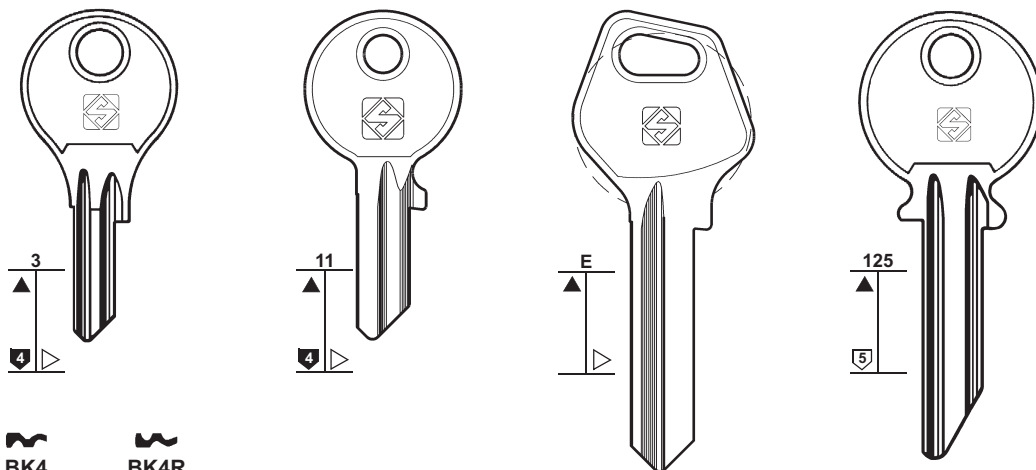

- BK4
- BK4R
- BK8
- BK8R

BK11R

BK26

LT1

METEOR - YALE



31

PER / FOR

BKS (D)
METEOR
YALE
 + LITTO (113)
 + YALE (193-194)

PER:
FOR:

BKS

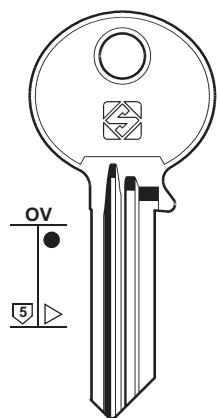

Serie 1000

- | | | | | |
|-------|--------|--------|--------|--------|
| BK5-1 | BK5-9 | BK5-17 | BK5-25 | BK5-33 |
| BK5-2 | BK5-10 | BK5-18 | BK5-26 | BK5-34 |
| BK5-3 | BK5-11 | BK5-19 | BK5-27 | BK5-35 |
| BK5-4 | BK5-12 | BK5-20 | BK5-28 | |
| BK5-5 | BK5-13 | BK5-21 | BK5-29 | |
| BK5-6 | BK5-14 | BK5-22 | BK5-30 | |
| BK5-7 | BK5-15 | BK5-23 | BK5-31 | |
| BK5-8 | BK5-16 | BK5-24 | BK5-32 | |

PER:
FOR:

BKS

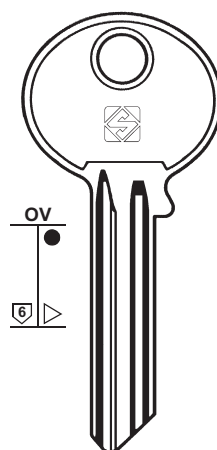

Serie 1000

- | | | | | |
|-------|--------|--------|--------|--------|
| BK6-1 | BK6-9 | BK6-17 | BK6-25 | BK6-33 |
| BK6-2 | BK6-10 | BK6-18 | BK6-26 | BK6-34 |
| BK6-3 | BK6-11 | BK6-19 | BK6-27 | BK6-35 |
| BK6-4 | BK6-12 | BK6-20 | BK6-28 | |
| BK6-5 | BK6-13 | BK6-21 | BK6-29 | |
| BK6-6 | BK6-14 | BK6-22 | BK6-30 | |
| BK6-7 | BK6-15 | BK6-23 | BK6-31 | |
| BK6-8 | BK6-16 | BK6-24 | BK6-32 | |



32

PER / FOR

BKS (D)

+ LITTO (113)

+ YALE (193-194)

BLASER (CH)

VADETO

WILKA

BLINKY (PRC)

BLOCKSHAFT (I)

BLOCTOUT (F)

+ BRICARD (35)

BLOCUS (F)

+ PREFER (142)

+ RONIS (146)

BMB (D)

BODA (FIN)

+ CES (41-42-43-44)

PER:
FOR:

BKS

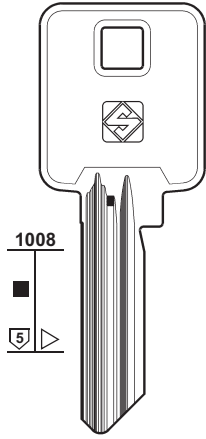

1008



BK10-00
Serie 2000

BK10-01

BK10-07

BK10-13

BK10-19

BK10-02

BK10-08

BK10-14

BK10-20

BK10-03

BK10-09

BK10-15

BK10-21

BK10-04

BK10-10

BK10-16

BK10-22

BK10-05

BK10-11

BK10-17

BK10-23

BK10-06

BK10-12

BK10-18

BK10-30

PER:
FOR:

BLASER

BLINKY

BLOCKSHAFT

BLOCUS

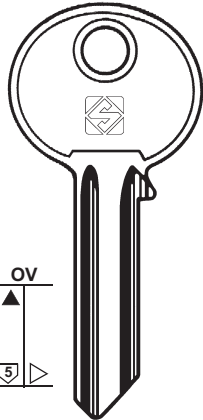

BLA3

BLA1

BLA2
WILKA

VADETO

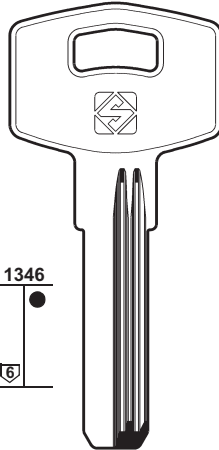

BNK1

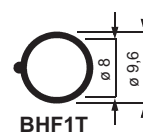
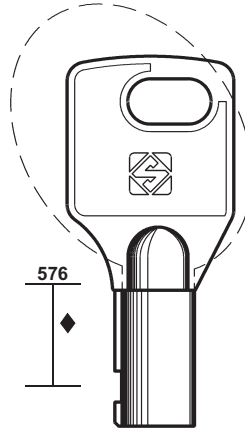

BHF1T

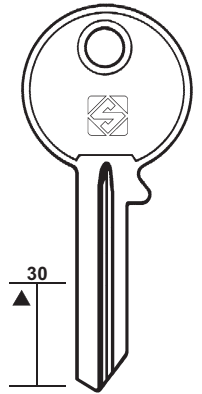

BL1

BL1R

PER:
FOR:

BMB

BODA

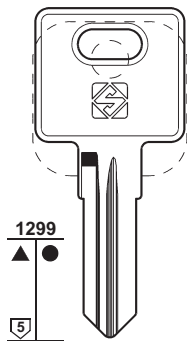

BMB1

BMB1R

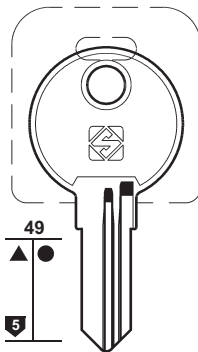

BMB2

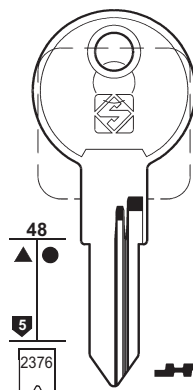

BMB3
A ... 1-200

BMB5
A ... 401-600

BMB3R
A ... 1-200

BMB4
A ... 201-400

BMB4R
... 1-2-3

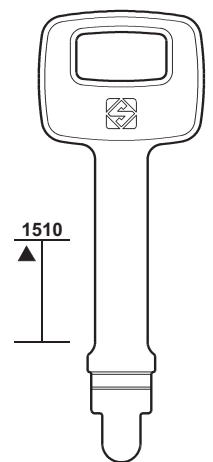

BDA10

PER: FOR:	BOMMER	BOMORO	BÖRKEY
	 BOR1 BOR1R	 BO2 BO2R LAPORTE - PRESTA	 BO6 BO6R HUWIL BY1

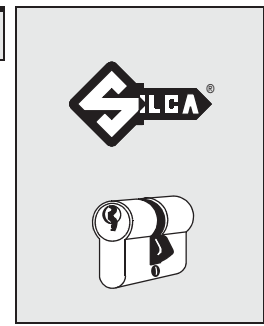

33

PER / FOR
BOMMER (USA)
BOMORO (D) HUWIL LAPORTE PRESTA
BÖRKEY (D) + KABA (102)
BOSS (I) MARLIN
BOTT (F) CES (42)
BRABANTIA (E) CLAUSOR (51) ME-FA (122)
BRASIL (BR)

PER: FOR:	BOSS	BRASIL
	 BOS1 BOS3 mm 60 MARLIN mm 70-90	 BRA1R BRA2R BRA3R

PER: FOR:	BRASIL			
	 BRA16R	 BRA7R 1-2-3-4-5 1-2-3-4-5-6	 BRA9R	 BRA10R



34

PER / FOR

BRASIL (BR)

BRETER (I)
GIUSSANI
ZADI

+ GIUSSANI (86)

PER:
FOR:

BRASIL

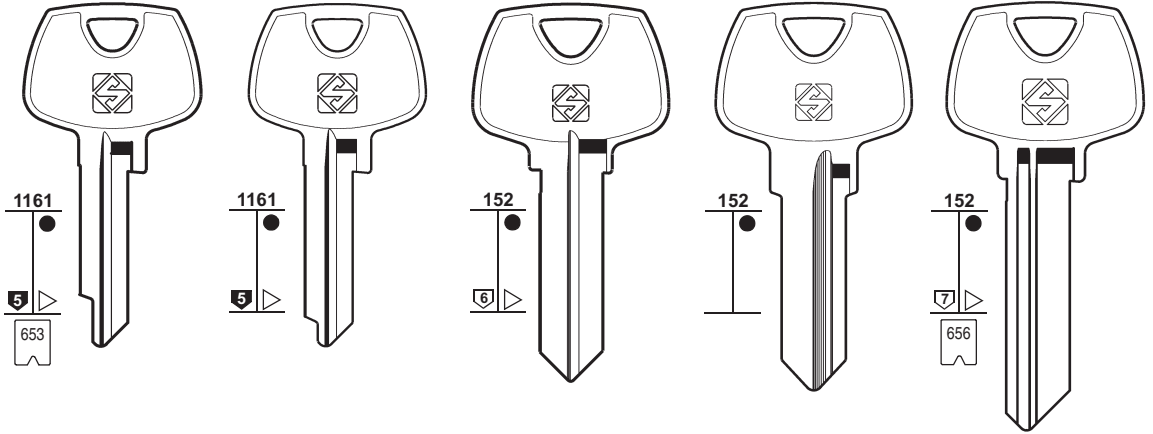

BRA6R

..... 1-2-3-4-5-6



BRA11R



BRA8R



BRA15R



BRA5

..... 1-2-3-4-5-6-7

PER:
FOR:

BRETER

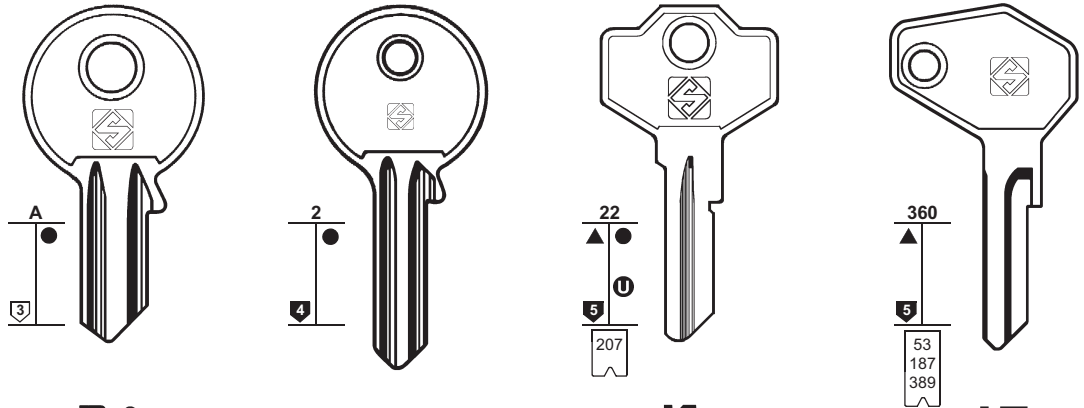

BR1



GS3



GS3R



SM1

G... 0-480
... 3001-3480
G... 3001-3480
... 9001-9741
G... 9001-9741



ZD7

... 0001-1625
E... 1-500
... 501-710
... 9001-9500



GIUSSANI



GIUSSANI



ZADI

PER:
FOR:

BRETER

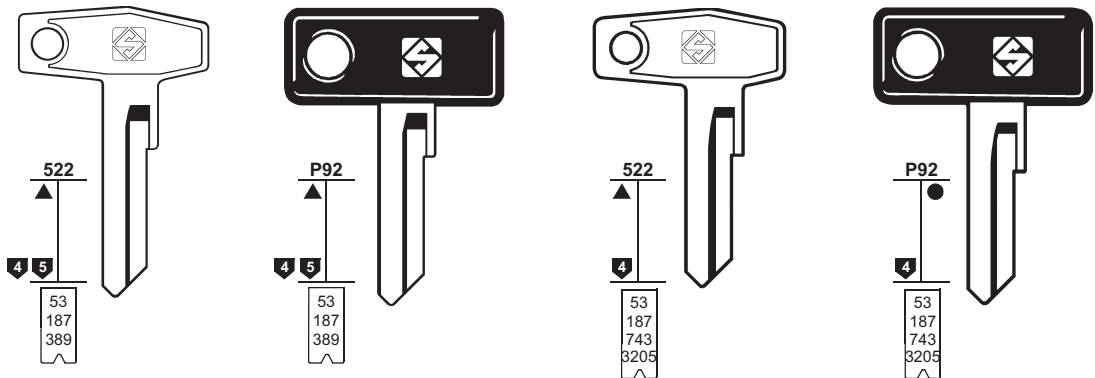

ZD9

... 1-1625
E... 500
... 501-710
... 9001-9500
... 5001-6278



ZD9P

... 1-1625
E... 500
... 501-710
... 9001-9500
... 5001-6278



ZD11

... 1-1625
E... 1-500
... 5001-6278
E... 501-710
... 1234
H... 100-341



ZD11P

... 1-1625
E... 1-500
... 5001-6278
E... 501-710
... 1234
H... 100-341



ZADI



ZADI



PER:
FOR:

BRICARD

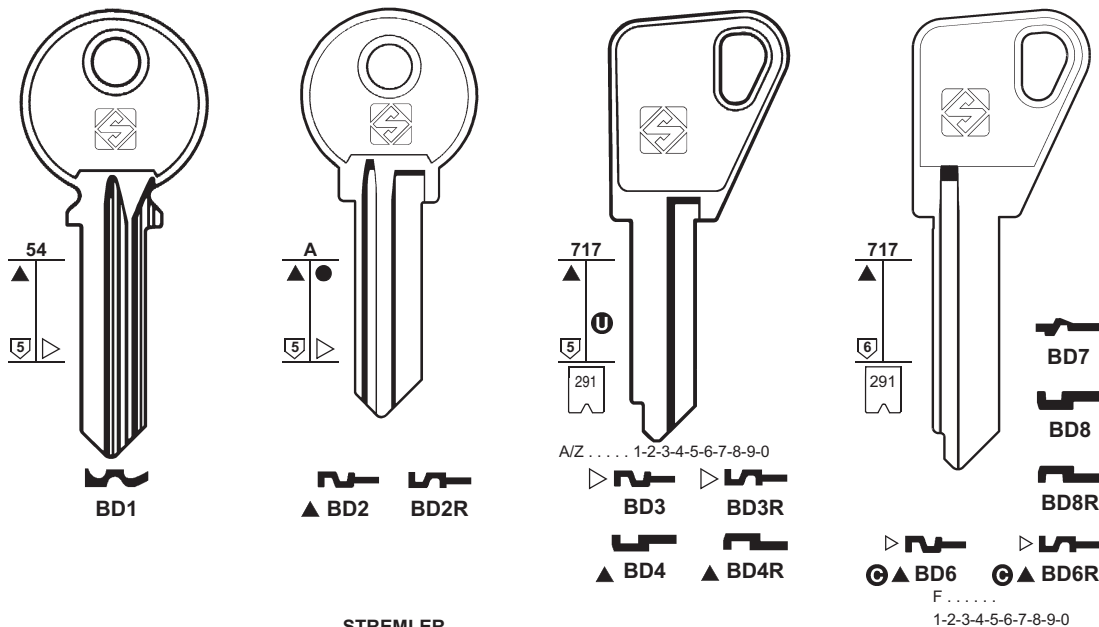

35

PER / FOR

- BRICARD (F)**
 ABUS
 BLOCTOUT
 INLOC
 STREMLER
 + ABUS (7-10)
 + CISA (48-49)
 + G.R. (90)
 + KWIKSET (108)
 + LOB (114)
 + SARGENT (150)

PER:
FOR:

BRICARD

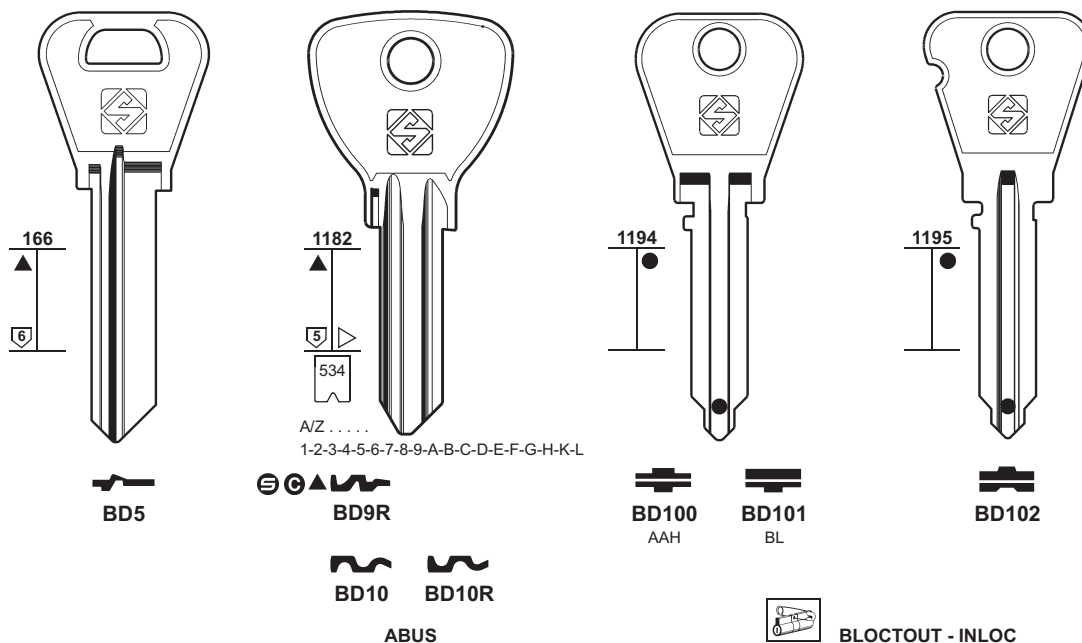

PER:
FOR:

BRICARD

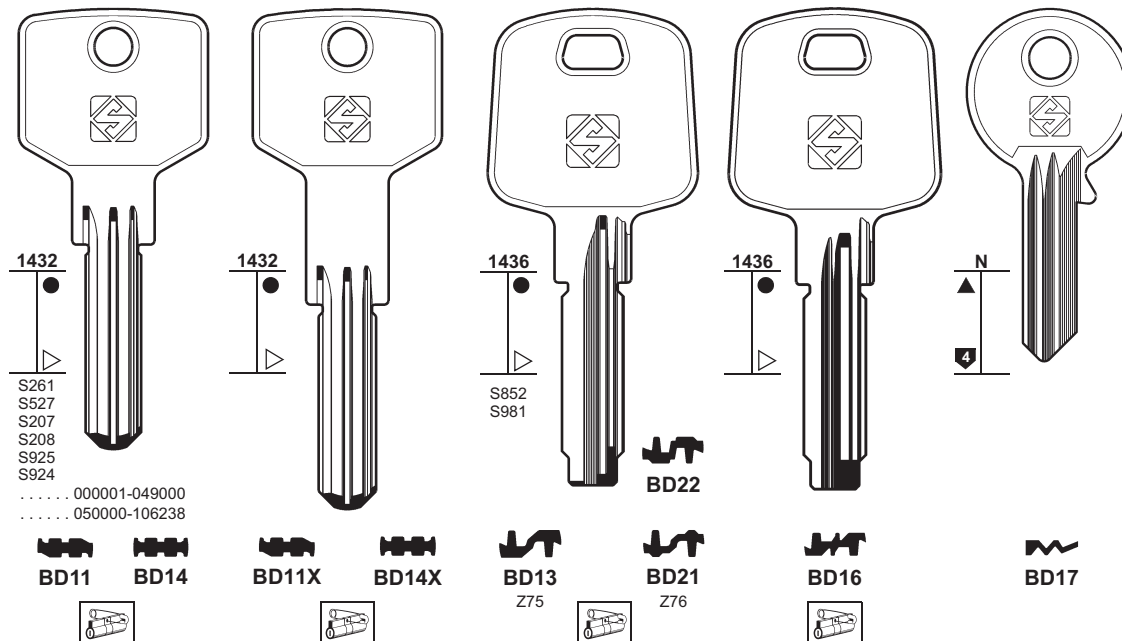



36

PER / FOR

BRUMME (D)

FANA

FTH

+ ZEISS-IKON (201)

BSS (SCG)

BANE SEKULIĆ

+ URBIS (180)

BTV (E)

AGA (10)

DOM (61)

STS (162)

BUFFO (GR)

ABUS (7-9)

BUG (D)

CORONA (55)

BUGA (F)

BASI

CITY

IFAM

BULAT (PRC)

BULLDOG (GB)

BULLOCK (I)

ZADI (200)

BURAM (YU)

PER: **BRUMME**

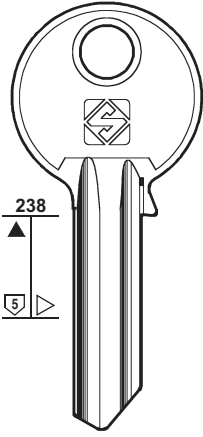

238
▲
5



FANA - FTH

BSS

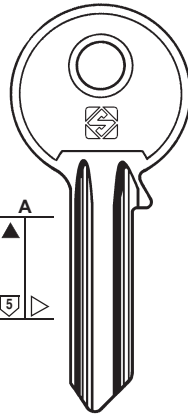

A
▲
5



BS1

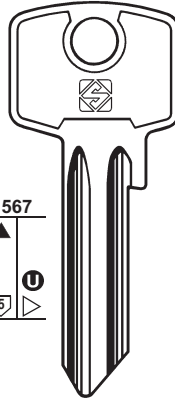

567
▲
5



BS2



▲ BS7

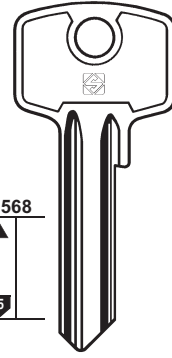

568
▲
5



BS3

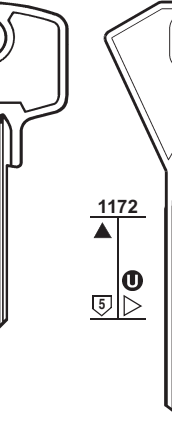

▲ BS4R



BS4R

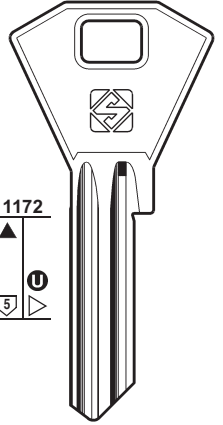

1172
▲
5



▲ BS5



BS5R

BANE SEKULIĆ

PER: **BSS**

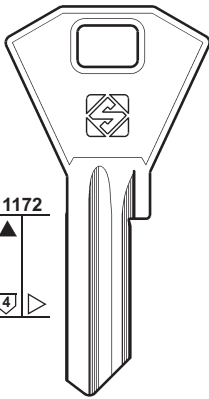

1172
▲
4



BS6R

BUGA

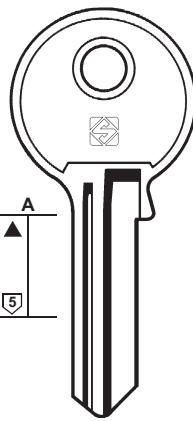

A
▲
5



CS33

CS33R

BASI



mm 50-60

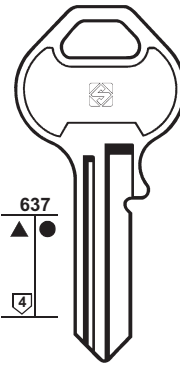

637
▲
4



▲ CS32

CS32R

BASI - CITY



mm 40

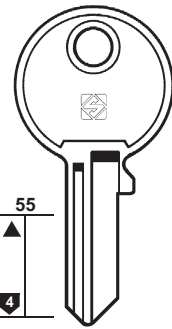

55
▲
4



CS26

CS26R

CITY



mm 30

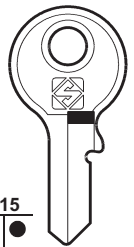

215
▲
3



CS23

CS23R

BASI - IFAM



mm 20

PER: **BULAT**

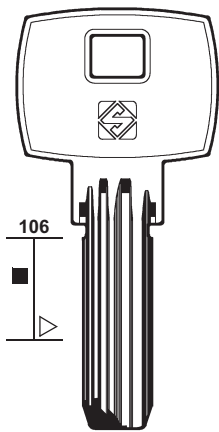

106
■
▶



BUT1R



BULLDOG

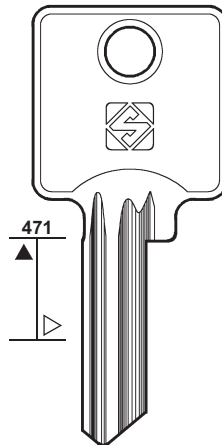

471
▲
▶



BLG1

BURAM

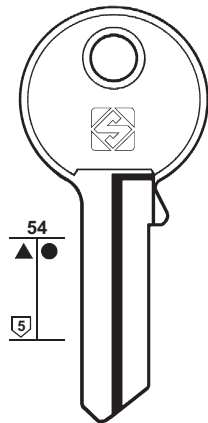

54
▲
5



▲ BU1

BU1R

PER:
FOR:

BURG

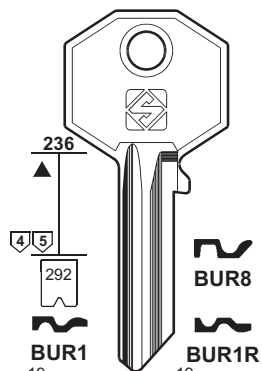

BUR1	BUR8	BUR1R
19	19	19
20	20	20
21	22	21
23	24	23
27	28	27
29	30	29
31	32	31
33	34	33
49	799	49
769	0-1-2-3-4-5-6	769
799	0-1-2-3-4-5-6	799

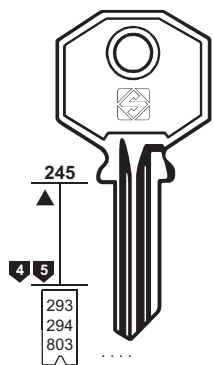

BUR2
11
12
13
14
15
16
17
18
25
30
35
36
37
38
40
41
42
43
44
45
47
50
51
52



BUR2	BUR2R
11	11
12	12
13	26
14	46
15	309
16	329
17	349
18	369
25	389
30	419
35	439
36	459
37	519
38	539
40	559
41	579
42	599
43	619
44	639
45	669
47	679
50	699
51	719
52	739
	759
	789
	809
	819
	829

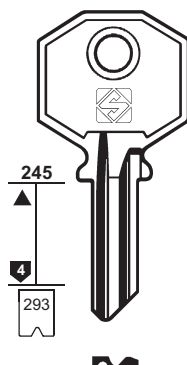

BUR6
11
12
259
269
279
0-1-2-3-4-5-6

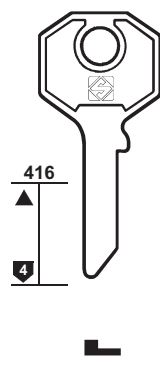
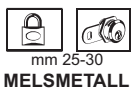

BUR7
11
12
259
269
279
0-1-2-3-4-5-6



37

PER / FOR

- BURG (D)**
- MELSMETALL
- + ABUS (8)
- + HOPPE (93)
- + MELSMETALL (122)
- + OJMAR (134)
- + RONIS (147)
- + VIRO (187)
- + ZEISS-IKON (201)

PER:
FOR:

BURG

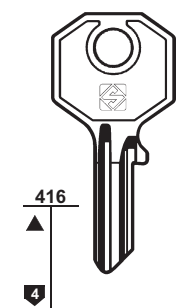

BUR11
BUR4

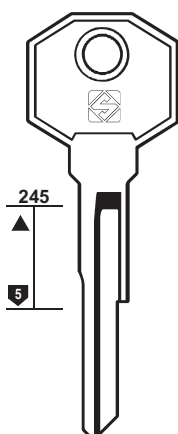

BUR5

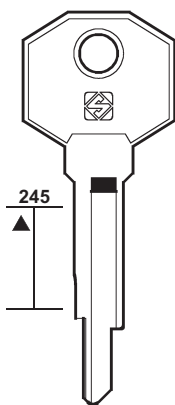

BUR12

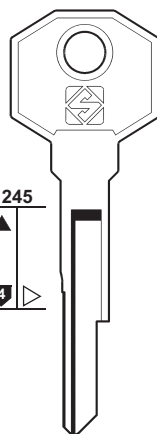

BUR19

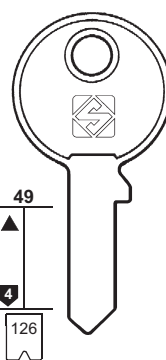

BUR3 **BUR3R**
BUR10R

M... 601-983



PER:
FOR:

BURG

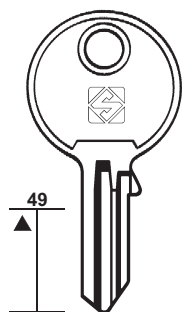

BUR9

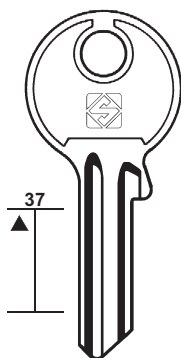

BUR15

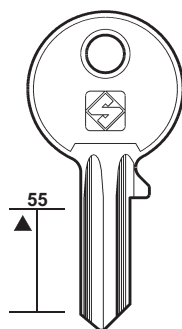

BUR16

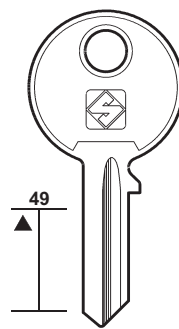

BUR17R



38

PER / FOR

BURG (D)
HOPPE
OTTO

- + ABUS (8)
- + HOPPE (93)
- + MELSMETALL (122)
- + OJMAR (134)
- + RONIS (147)
- + VIRO (187)
- + ZEISS-IKON (201)

PER:
FOR:

BURG

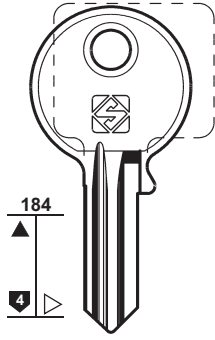

BUR22



mm 30-35

BUR22R

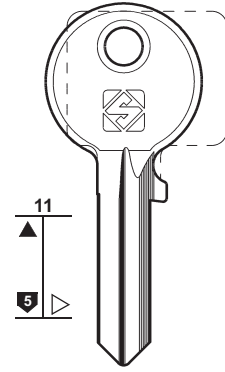

BUR23

BUR23R



mm 40

BUR29
39R/68R

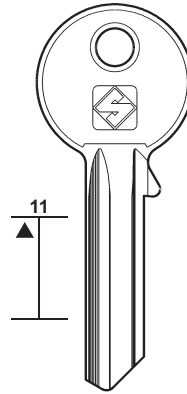

BUR18

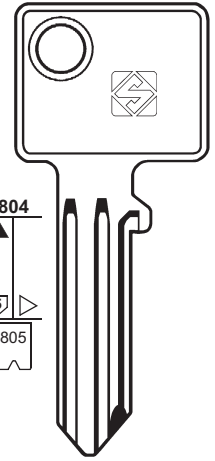

BUR13

- (600/40) 123456
- (600/50) 123456
- (600/60) 123456

PER:
FOR:

BURG

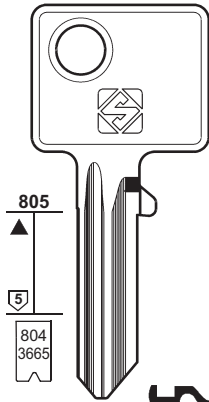

BUR14R

- ▲ ● BUR21
- (116/40)
- (116/50)
- (116/60)
- 123456



mm 50

BUR21R

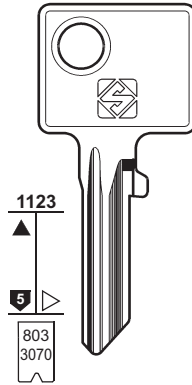

BUR20 BUR20R

- (116/30)
- 0-1-2-3-4-5
- 1-2-3-4-5-6

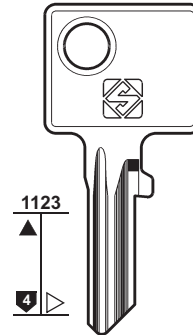

BUR26

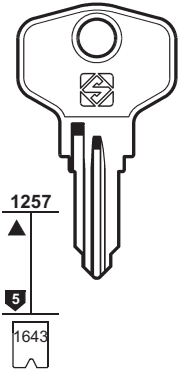

BUR24R
2W ... 1-246

HOPPE - OTTO

PER:
FOR:

BURG

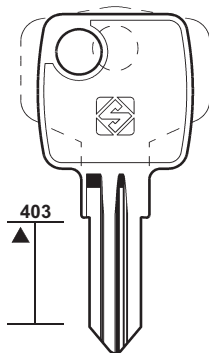

BUR28R
34W

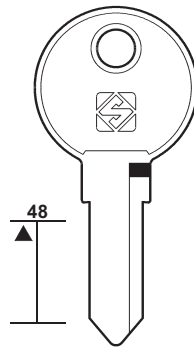

BUR31 BUR31R

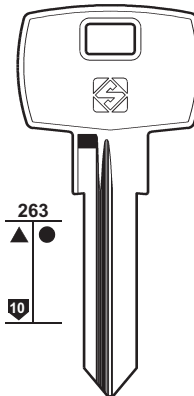

BUR32 BUR34R
26W

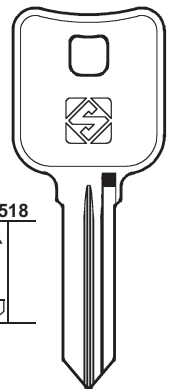

BUR38



PER:
FOR:

BURG

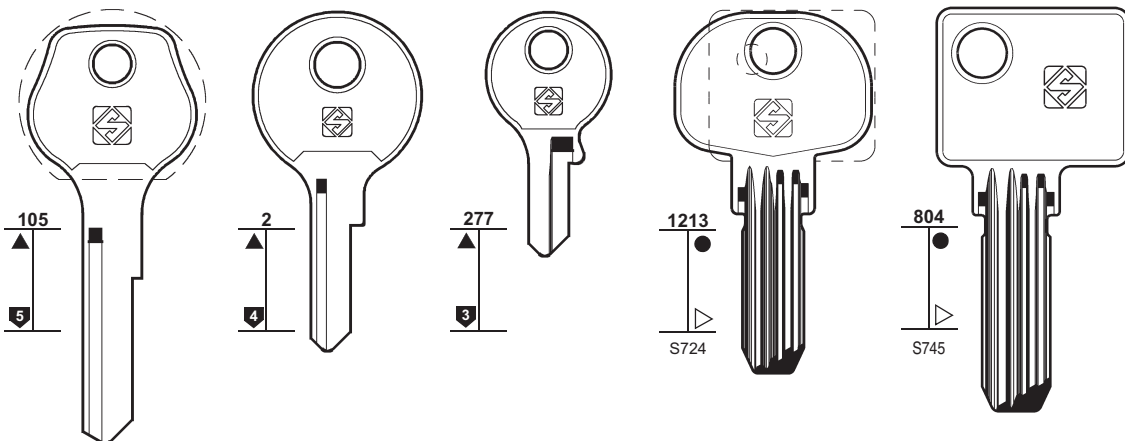

BUR57R
71R

BUR55R
77R

BUR56
405/20

BUR27
75W

BUR33
76W



39

PER / FOR

BURG (D)

- + ABUS (8)
- + HOPPE (93)
- + MELSMETALL (122)
- + OJMAR (134)
- + RONIS (147)
- + VIRO (187)
- + ZEISS-IKON (201)

BUS (D) KROST

BUVA (D) GERA KALE

BV (D)

- + CAS-CISMA (40)
- + FASEM (77)

BWS (GB)

- + CORBIN (53)

CAB (I)

- + CAS-CISMA (40)
- + SIMECA (155)
- + YALE (194)

CAF (I)

CAM (F)

- + ISEO (97)

PER:
FOR:

BUS

BUVA

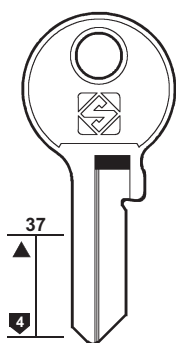

BUS1

KROST

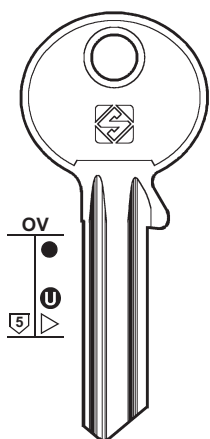

BVA1 ▲ **BVA1R**

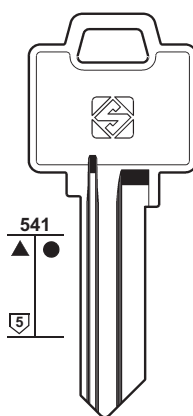

BVA3

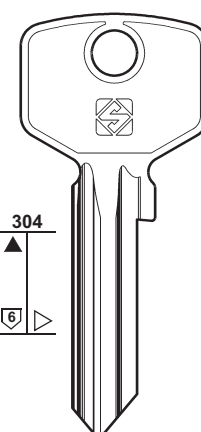

BVA4

GERA - KALE

PER:
FOR:

CAB

CAF

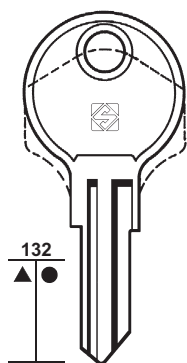

CAB1

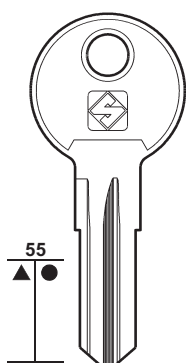

CAB2R

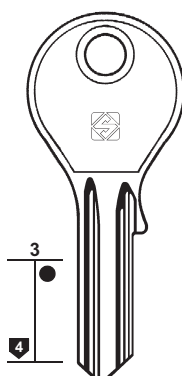

CAF1 **CAF1R**

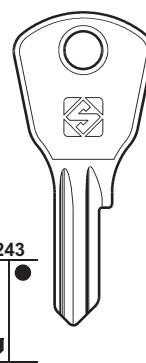

CAF2 **CAF2R**



40

PER / FOR

CANDA VEN CV (V)

CAP (F)

- 👁 CITY (51)
- 👁 KRV (105)
- 👁 PREFER (142)
- 👁 VACHETTE (184)

CARACAL (RC)

CARAT

- 👁 YALE (194)

CAROLI (I)

- 👁 MERONI (193)

C.A.R.S. (I)

- 👁 OMA (135)

CASAS (E)

- 👁 AGA (11)

CAS-CISMA (I)

- BV
- CAB
- DOMUS
- ETNA
- FTH
- GSA
- GUARDIAN
- LAPERCHÉ
- M
- MST
- SISO
- STIQAM
- STREMLER
- TECHNAL
- TESTA

CASI (D)

- 👁 SCHLECHTENDAHL (152)

CASIO (I)

- 👁 OLIVETTI (134)

CASH-BOX (D)

- + 👁 CLAUSOR (51)
- + 👁 KIFERM (106)

CASMA (I)

- 👁 CES (43)
- 👁 P.C. (140)

CATOR (F)

- 👁 RONIS (146-147)

CAVERS (F)

- 👁 AZBE (24)
- 👁 CISA (48)
- 👁 CITY (51)
- 👁 SPIDER (159)

CAYS (E)

PER:
FOR:

CANDA VEN CV

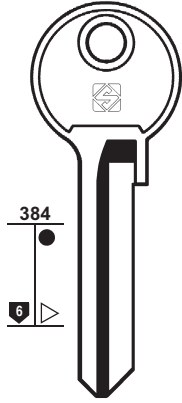

384
6

CV1

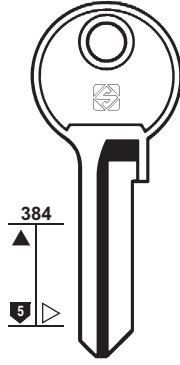

384
5

CV2

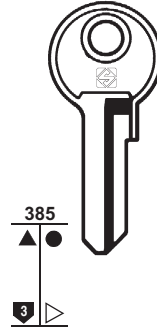

385
3

CV3



CARACAL

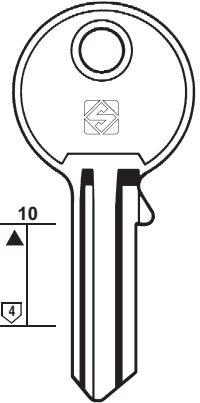

10
4

CAR1

PER:
FOR:

CAS-CISMA

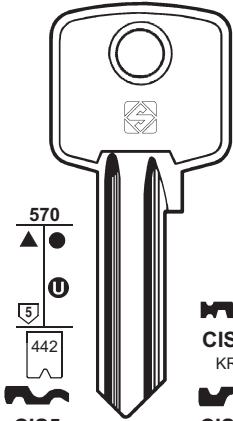

570
442

CIS5

- 1234567
- 123456789AB
- L..... 1001-2178
- L..... 14001-14500
- L..... 15001-18199
- 20001-20625



CIS11
KRL



CIS5R



CIS8

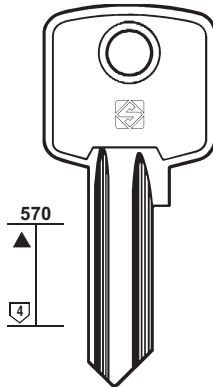

570
4

CIS6 ● CIS6R

ETNA - GSA
LAPERCHÉ - STREMLER

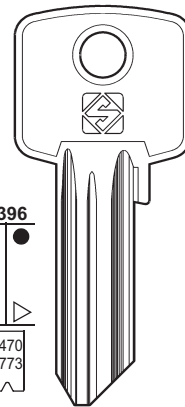

1396
1470
2773

CIS9

..... 12345678AB

CIS12

..... 12345678

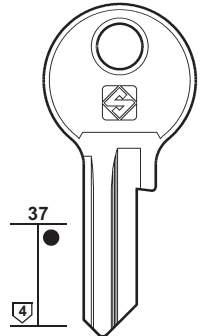

37
4

CIS7

PER:
FOR:

CAS-CISMA

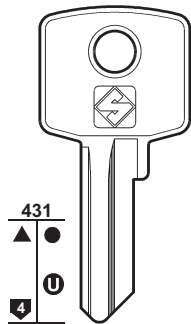

431
4

CIS2

CIS4 ● CIS4R ●

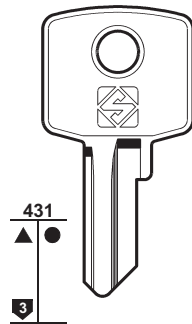

431
3

CIS1 CIS3



BV - CAB - DOMUS - GUARDIAN
M - MST - SISO - STIQAM - TESTA

CASH-BOX

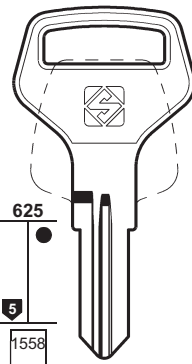

625
1558

CAX1R

... 101-170
... 201-270

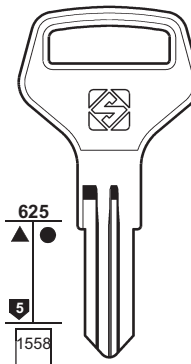

625
1558

CAX2R

... 0-1-2
... 301-370



CAYS

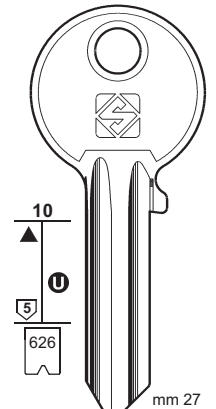

10
626

mm 27

0-1-2-3-4-5-6-7-8-9

⊕ CYS1 CYS1R ▲

PER: FOR:	CAYS	CCC	CEE	CEMA
				ELFIN - LAMPA

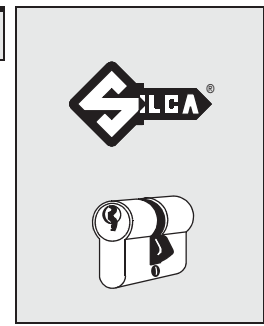

41

- PER / FOR
- CAYS (E)
 - CCC (IL)
 - CEE (P)
 - CCL (F)
 - CORBIN (55)
 - CEKA (D)
 - HUWIL (94)
 - CEMA (I)
 - ELFIN
 - LAMPA
 - CENTURY (GB)
 - ALLGOOD
 - CES (D)
 - BODA
 - ELZETT
 - FRECOV
 - HÄFELE
 - HANNO
 - JOSTA
 - KARDEX
 - KIND
 - KNAPP
 - MAUSER
 - NEMEF
 - OJMAR
 - SÄNTIS
 - STUV
 - VOKO
 - WASO
 - WECO

PER:
FOR:

CENTURY

	ALLGOOD			

PER:
FOR:

CES

ELZETT FRECOV HÄFELE HANNO JOSTA KARDEX KIND KNAPP MAUSER NEMEF OJMAR VOKO WASO WECO	BODA ELZETT FRECOV KNAPP	ELZETT FRECOV HÄFELE HANNO JOSTA KARDEX KIND KNAPP MAUSER NEMEF OJMAR SÄNTIS VOKO WASO WECO	BODA ELZETT FRECOV KNAPP 12345678 CE34 123456789 CE35 123456789 CE36 123456789 12345678 CE10 CE21R WS ... 401-410 CE29R	FRECOV HÄFELE HANNO JOSTA KARDEX KIND KNAPP MAUSER NEMEF OJMAR VOKO WASO WECO	BODA FRECOV KNAPP OJMAR	N ... 1-50 ... 101-400	



42

PER / FOR

CES (D)
 BERRY
 BODA
 BOTT
 COMBA
 ELZETT
 FEFI
 FRECOV
 FUHR
 GIESCHE
 HÄFELE
 HANNO
 HÖHRMANN
 JOSTA
 KARDEX
 KIMA
 KIND
 KNAPP
 MAUSER
 MBB
 NEMEF
 OJMAR
 OTIS
 SÄNTIS
 SIEBAU
 SOLID
 SS
 STUV
 TORE
 TRITON
 VOKO
 WASO
 WECCO

PER:
FOR:

CES

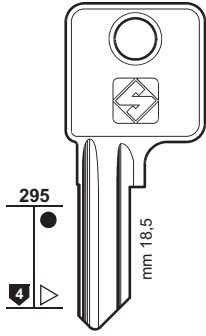

CE33

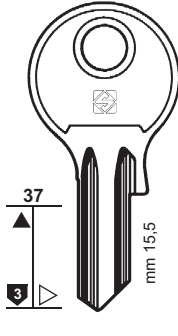

CE13
 ELZETT
 FRECOV
 HÄFELE
 HANNO
 JOSTA
 KARDEX
 KIND
 KNAPP
 MAUSER
 NEMEF
 OJMAR
 VOKO
 WASO

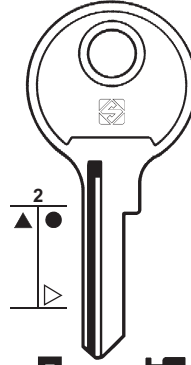

CE11 ▲ CE11R
 BOTT

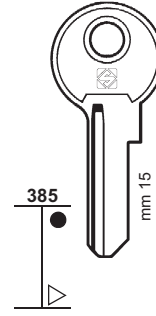

CE19
 CE19R

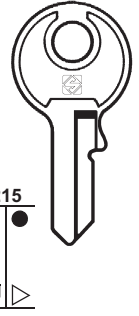

CE30
 CE30R

PER:
FOR:

CES

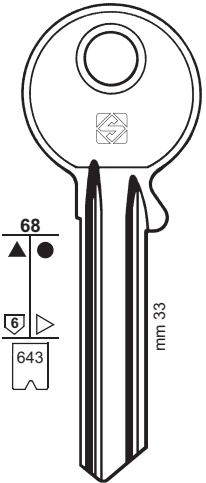

CE3 CE3R

 1-2-3-4-5-6-7-8-9-0
 BODA

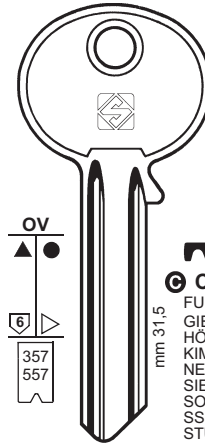

CE1
 FUHR
 GIESCHE
 HÖHRMANN
 KIMA
 NEMEF
 SIEBAU
 SOLID
 SS
 STUV

.....
 1-2-3-4-5-6-7-8-9-0
 A
 1-2-3-4-5-6-7-8

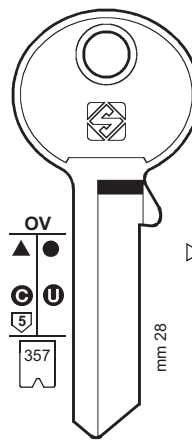

CE5

.....
 1-2-3-4-5-6-7-8-9-0
 BB 1-12000
 BBF 1-12000
 BT 1-12000
 TS 1-12000

CE2
 BERRY
 COMBA
 FEFI
 HÄFELE
 HÖHRMANN
 MBB
 NEMEF
 OTIS
 SÄNTIS
 SOLID
 STUV
 TORE
 TRITON

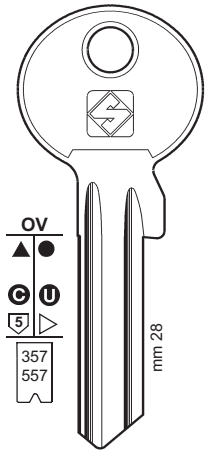

CE2X

PER:
FOR:

CES

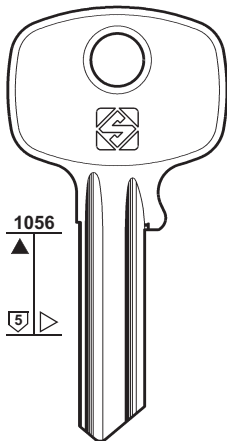

CE40

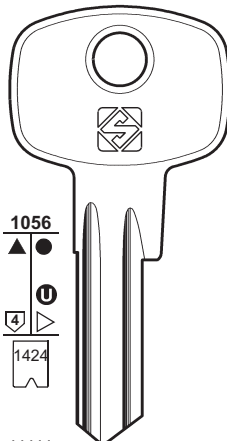

CE41

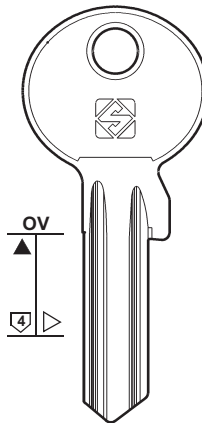

CE41X-OV

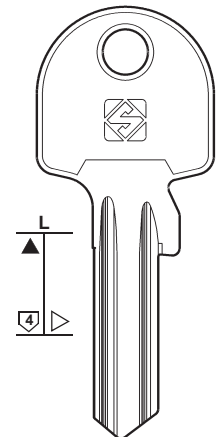

CE41XL

.....
1-2-3-4-5-6-7-8-9-0

HÄFELE

PER:
FOR:

CES

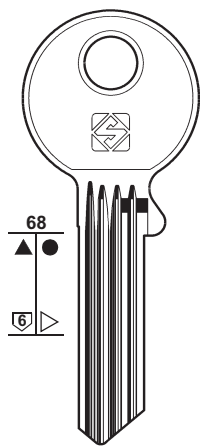

CE17XPS

CE17WPS

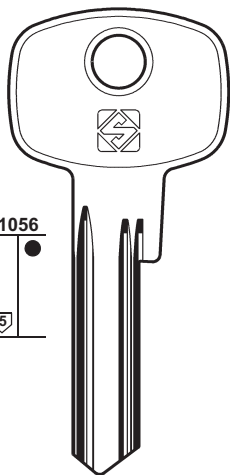

CE127
NEMEF

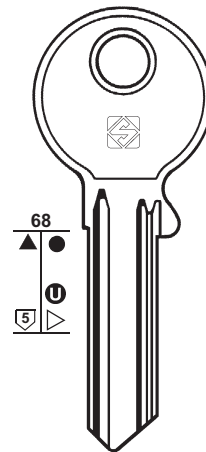

CE20

CE114
NEMEF



43

PER / FOR

CES (D)
BODA
CASMA
NEMEF
SPEEDAL

PER:
FOR:

CES

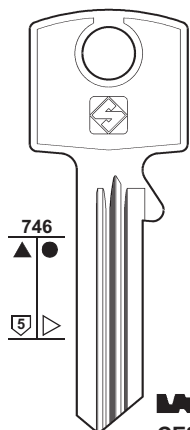

CE23R

CE28

CE31

CE24R

CE32R

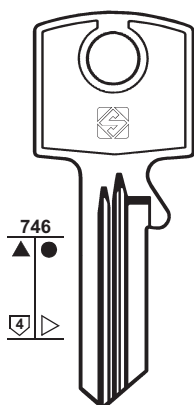

CE25R

CE27 CE26R

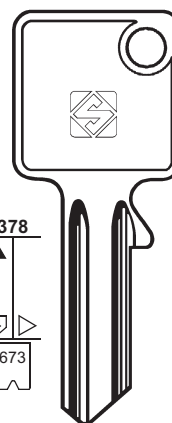

CE12
..... 1234567890

CASMA - SPEEDAL

PER:
FOR:

CES

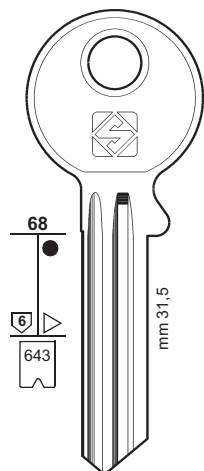

CE15 CE39
 CE16

15 CE14-15

16 CE14-16

17 CE14-17

18 CE14-18

25 CE14-25
..... 1234567890

26 CE14-26

27 CE14-27

28 CE14-28

35 CE14-35

36 CE14-36

37 CE14-37

38 CE14-38

45 CE14-45

46 CE14-46

47 CE14-47

48 CE14-48

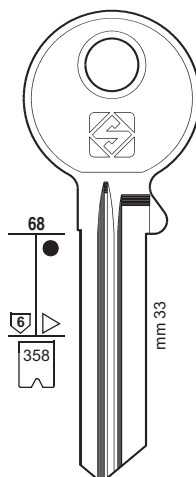

15 CE22-15
 16 CE22-16
12..... 1-100000

17 CE22-17

18 CE22-18

25 CE22-25

26 CE22-26

27 CE22-27

28 CE22-28

35 CE22-35

36 CE22-36

37 CE22-37

38 CE22-38

45 CE22-45

46 CE22-46

47 CE22-47

48 CE22-48

BODA

BODA



44

PER / FOR

CES (D)
BODA
THÖMEE

PER:
FOR:

CES

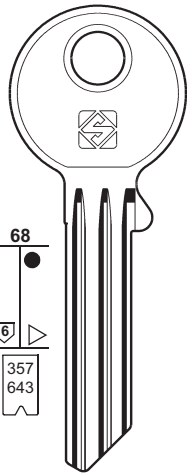

.....
1-2-3-4-5-6-7-8-9-0

 CE130-1 C/2	 CE130-2 B/2	 CE130-3 B/1	 CE130-4 C/4	 CE130-5 A/4	 CE130-6 A/5	 CE130-7 C/5
 CE130-8 C/1	 CE130-9 A/2	 CE130-10 D/1	 CE130-11 A/34	 CE130-12 B/3	 CE130-13 X/678	 CE130-14 1/68
 CE130-15 4/67	 CE130-16 4/68	 CE130-17 AB5	 CE130-18 B1/5	 CE130-19 C1/5	 CE130-20 AD1	 CE130-21 AD4
 CE130-22 A1-5	 CE130-23 AB1-3	 CE130-24 D1-5	 CE130-25 D/2	 CE130-26 D/5	 CE130-27 D/4	 CE130-28 A/3
 CE130-29 C/34	 CE130-30 C/3	 CE130-31 B/34	 CE130-32 B/5	 CE130-33 B/4	 CE130-34 D/3	 CE130-35 A/1

BODA - THÖMEE

PER:
FOR:



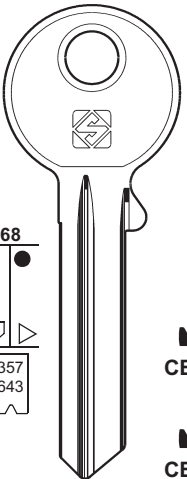





CES

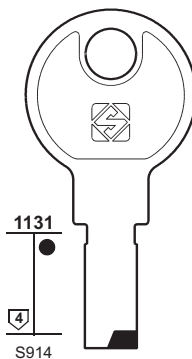

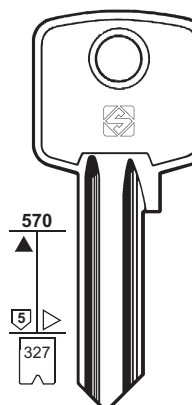
.....
1-2-3-4-5-6-7-8-9-0

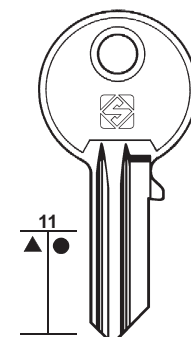

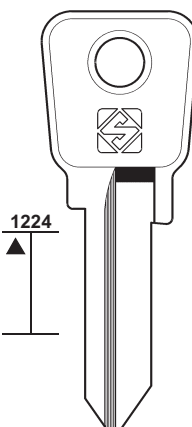



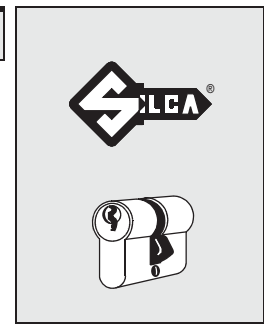



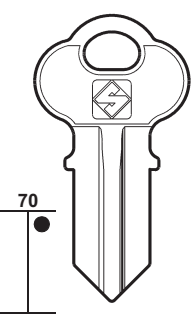





 CE129-1 R/8	 CE129-2 Z/568	 CE129-3 1/678	 CE129-4 2/568	 CE129-5 R/7	 CE129-6 Z/68	 CE129-7 G/56
 CE129-8 G/68	 CE129-9 R/R	 CE129-10 G/5	 CE129-11 G/6	 CE129-12 3/567	 CE129-13 G/67	 CE129-14 3/R
 CE129-15 3/568	 CE129-16 Y/567	 CE129-17 G/57	 CE129-18 2/R	 CE129-19 1/56	 CE129-20 Y/68	 CE129-21 1/67
 CE129-22 3/68	 CE129-23 G/678	 CE129-24 3/58	 CE129-25 3/678	 CE129-26 4/578	 CE129-27 4/568	 CE129-28 3/57
 CE129-30 4/678	 CE129-31 3/578	 CE129-32 2/57	 CE129-33 Z/67	 CE129-34 G/578	 CE129-35 1/567	 CE129-36 1/G
 CE129-38 X/R	 CE129-39 4/78	 CE129-40 1/568	 CE129-41 G/8	 CE129-42 G/7	 CE129-43 X/6	 CE129-44 4/56
 CE129-46 Z/7	 CE129-47 2/56	 CE129-48 G/58	 CE129-49 2/67	 CE129-50 2/68	 CE129-51 4/567	 CE129-52 4/G
 CE129-54 X/G	 CE129-55 3/78	 CE129-56 Z/5	 CE129-57 2/G	 CE129-58 2/578	 CE129-59 Z/G	 CE129-60 Z/56
 CE129-62 X/58	 CE129-63 Y/67	 CE129-64 4/R	 CE129-65 Y/56	 CE129-66 Z/567	 CE129-67 Y/G	 CE129-68 Z/78
 CE129-70 2/58	 CE129-71 X/7	 CE129-72 1/58	 CE129-73 4/57	 CE129-74 X/67	 CE129-75 Y/6	 CE129-76 3/56
 CE129-78 Y/57	 CE129-79 Y/8	 CE129-80 Z/8	 CE129-81 2/567	 CE129-82 X/8	 CE129-83 Y/58	 CE129-84 3/67
 CE129-86 Z/6	 CE129-87 3/G	 CE129-88 2/678	 CE129-89 X/5	 CE129-90 R/6		

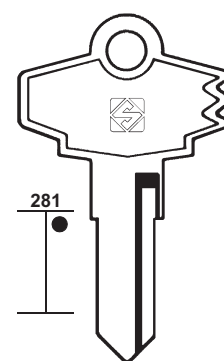

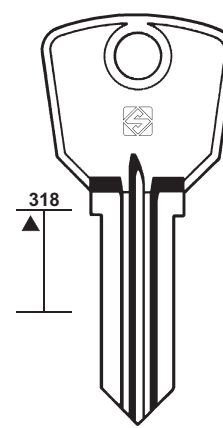



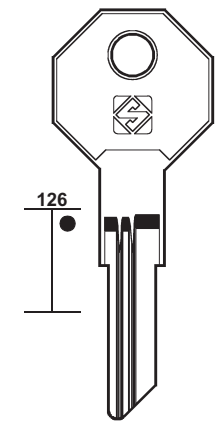



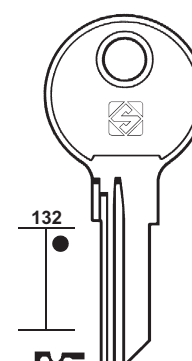

BODA - THÖMEE

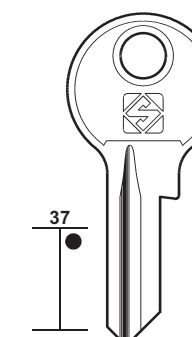
PER: FOR:	CES	CHAVO	CHEK	CHELIABINSK
	 <p>1131 S914</p> <p>MS . . . 1-20</p> <p>CE131</p>  	 <p>570</p> <p>S327</p> <p>CHV1 CHV1R</p>  	 <p>11</p> <p>CK1</p>  <p>CHEYLOCK</p> 	 <p>1224</p> <p>CLK1</p> 

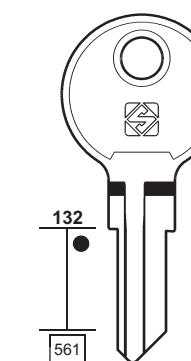

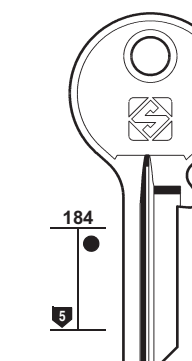
45

PER: FOR:	CHICAGO			
	 <p>70</p> <p>CH1</p>   <p>CH2</p>   <p>CH3 CH4</p>   <p>CH5 CH8</p> 	 <p>281</p> <p>CH6</p>   <p>ILLINOIS - ODA</p>	 <p>318</p> <p>CH7 CH7R</p>    <p>FORT</p>	 <p>126</p> <p>CH15</p>  

PER: FOR:	CHICAGO			
	 <p>132</p> <p>CH18</p>  <p>CH11 FR</p>  <p>CH13 XF</p> 	 <p>37</p> <p>CH12 XF</p>  <p>CH14 FR</p> 	 <p>132</p> <p>561</p> <p>CH10</p>  <p>CH24R</p> 	 <p>184</p> <p>5</p> <p>CH19</p>  <p>YA18</p>  <p>LL . . . 201-240 UM . . . 226-425 LL . . . 226-450 . . . 500-550 . . . 600-650</p> <p>CH27</p> 

STEELCASE

PER / FOR
CES (D)
CEV (I) IDRO-STOP (94)
CF (F) FTH (81)
CFP (D) WILKA (191)
CHANGE-O-MATIC (F) CORBIN (55)
CHAVO (P) + CISA (48) + SOFI-SONAFI (157)
CHEK (HK) CHEYLOCK
CHELIABINSK (RUS)
CHEYLOCK (HK) CHEK (45)
CHG (F) GABON (84)
CHICAGO (USA) FORT ILLINOIS ODA STEELCASE



46

PER / FOR

CHICAGO (USA)

- ACE
- ADEMCO
- AGA
- ALPHA
- EURO LOCKS
- FORT
- GEM
- IFAM
- L & F

CHRIST (D)

- DOM (60)
- HUWIL (94)

CHSS (RC)

CHUBB (GB)

- + AVA-CHUBB (24)

CIAL (BR)

CIB (F)

- FTH (81)
- OMIV (136)
- PREFER (142)
- UCEM (175)

CIBC (I)

- CISA (50)
- FTH (82)

CIC (I)

- BASI (28)
- CORNII (55)

CIEF (F)

CIELS (I)

PER:
FOR:

CHICAGO

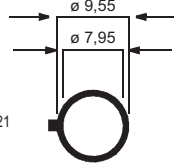
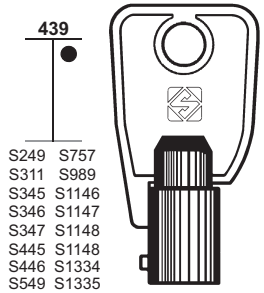

- ... 1-999
 - ... 2001-2100
 - ... 0123
 - ... 7654321
 - ... 7654321
 - ... 7654321
 - ... 1234567
 - ... 280001-285000
 - ... 320001-326000
 - ... 24568ABCDEFGHIJKLMNO
 - ... HD 0001-9400
 - ... HD 0001-9400
 - ... HMC 00001-31000
- ACE - ADEMCO - AGA - ALPHA
EURO LOCKS - FORT
GEM - IFAM - L & F

CH9T

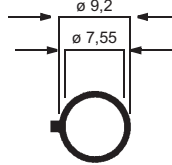
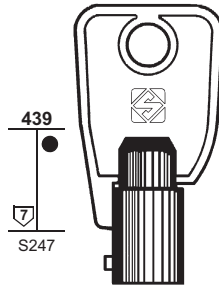

CH16T

... 7-6-5-4-3-2-1

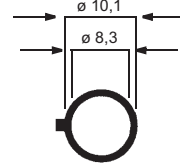
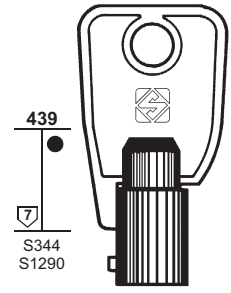

CH17T

... 123456
... X123456

PER:
FOR:

CHSS

CHUBB

CIAL

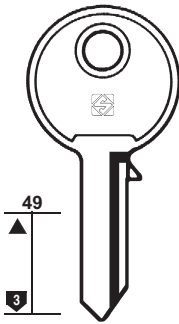

CHS1



mm 30

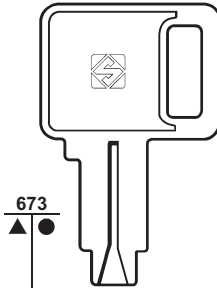

CHU5



1-2-3-4-5

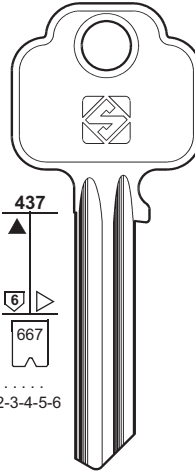

CHU6

1-2-3-4-5-6

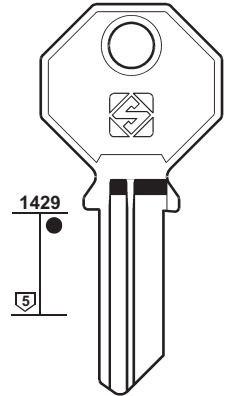

CIA1

5

PER:
FOR:

CIEF

CIELS

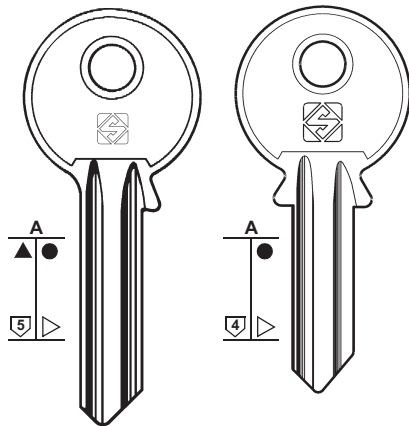

FEB2

● FEB2R

FEB1

FEB1R

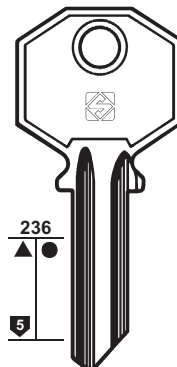

CLS1

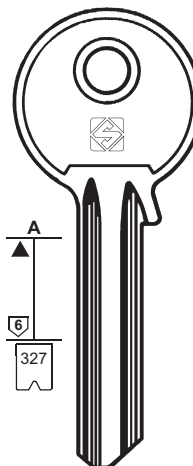

CLS242

● CLS3

● CLS220

CLS2

1-2-3-4-5-6



PER: **CIERRA SOLA**
FOR:

CIFIAL



47

PER / FOR
CIERRA SOLA (RA)

CIFIAL (P)
LE FEBURE

CIGNO (I)
CISA (50)

CILA-GENTILI (I)

CINA (RC)
SHANGHAI
+ SHANGHAI (153)

PER:
FOR:

CILA-GENTILI

PER:
FOR:

CINA



48

PER:
FOR:

CINA

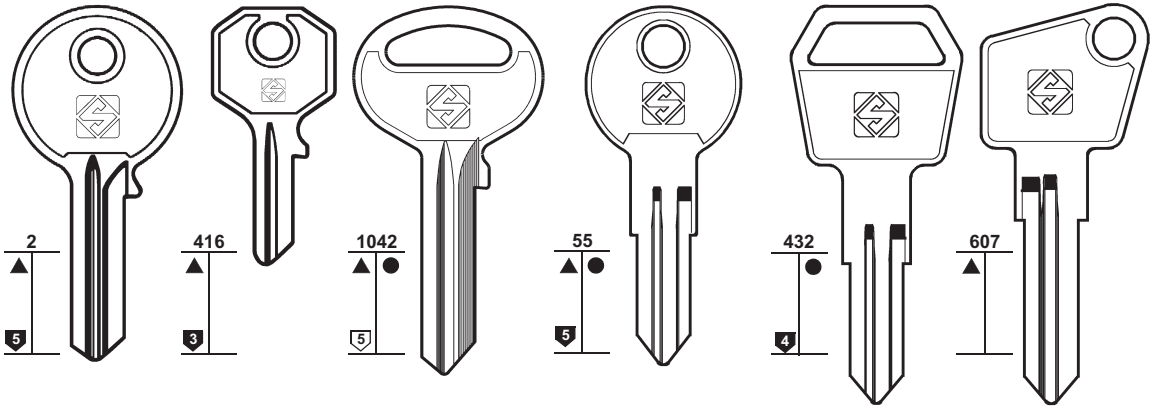

454



C555



555



RC3R ▲ RC4

ALI - EIKO



RC5



● RC5R



RC6



RC6R



RC7R



PER / FOR

CINA (RC)

555
ALI
EIKO
+ SHANGHAI(153)

CISA (I)

ABUS
ALA
ALF
BRICARD
CAVERS
CHAVO
DOBUS
ESCO
ESSENDIA
GEFI
GETE
GEVY
GTV
ITO
LOGO
NB
SCHÜCO
STANDARD
TIEFENTHAL
TZAFRER
UNIFERRO
+ ABUS (6-7-8-10)
+ ALA (13)

PER:
FOR:

CISA

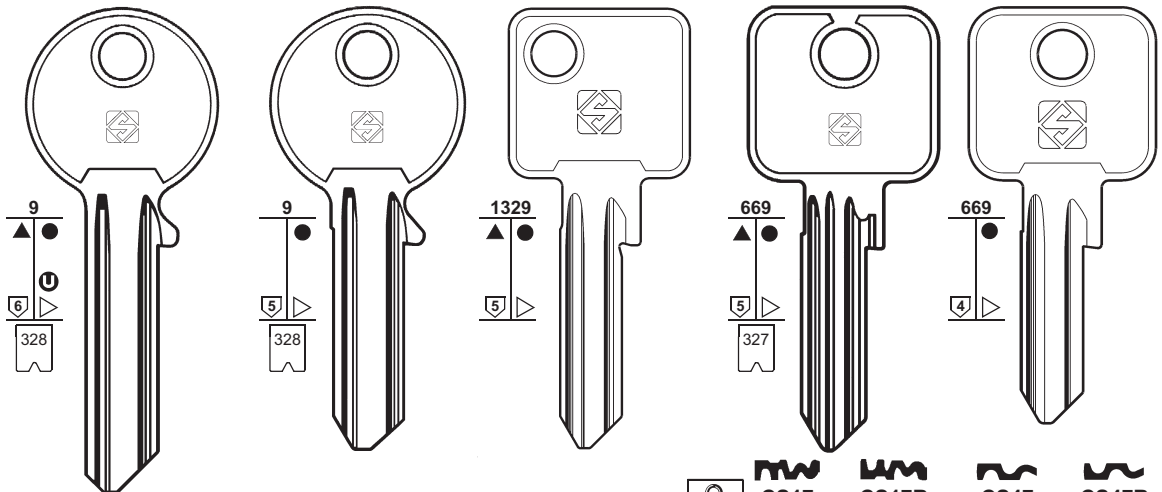

● CS501R



mm 70



CS501

..... 1-2-3-4-5



CS500R



CS500

..... 1-2-3-4-5



CS85

ABUS



CS17

mm 50-55-60-65
70-75-77-84-94



mm 50-60



CS17R

..... 1-2-3-4-5-6



ALA



CS47



mm 50-60



CS47R



mm 50-60

PER:
FOR:

CISA

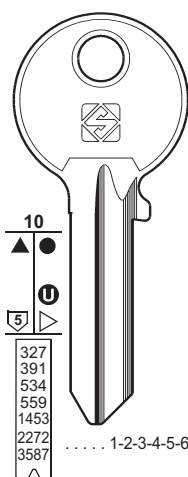

..... 1-2-3-4-5-6



mm 50-60

AY 1-6032
BA 1-6032
BB 1-6032
BC 1-6032
BD 1-6032
BJ 1-6032
BK 1-6032
BL 1-6032
BM 1-6032
BN 1-6032
BP 1-6032
BQ 1-6032
BR 1-6032
BS 1-6032
BT 1-6032
BU 1-6032
BY 1-6032
SA 1-6032
SB 1-6032
..... 123456
..... 123456789

CS206
ABUS
ALF
CHAVO
ESCO
ESSENDIA
GEFI
GETE
GTV
ITO
NB
SCHÜCO
STANDARD
TIEFENTHAL
UNIFERRO
P.....
00000-02360
E..... 1234567890ABCDEFGHI



CS13

BRICARD

..... 1-2-3-4-5-6

CS14

CS14R

..... 1-2-3-4-5-6

CS15

CS15R

..... 1-2-3-4-5-6

CS18

CS18R

LOGO

..... 1-2-3-4-5-6

CS24

CS24R

LOGO

..... 1-2-3-4-5-6

CS31

CS31R

..... 1-2-3-4-5-6

CS38

CS38R

..... 1-2-3-4-5-6

CS44

CS44R

..... 1-2-3-4-5-6

CS49

G28D



CS13R

BRICARD

..... 1-2-3-4-5-6

CS14R

CS14R

..... 1-2-3-4-5-6

CS15R

CS15R

..... 1-2-3-4-5-6

CS18R

CS18R

LOGO

..... 1-2-3-4-5-6

CS24R

CS24R

LOGO

..... 1-2-3-4-5-6

CS31R

CS31R

..... 1-2-3-4-5-6

CS138

G08D

..... 1-2-3-4-5-6

CS142

CS142

..... 1-2-3-4-5-6

CS44R

CS44R

..... 1-2-3-4-5-6

CS49

G16D

..... 1-2-3-4-5-6

CS147

CS147

..... 1-2-3-4-5-6

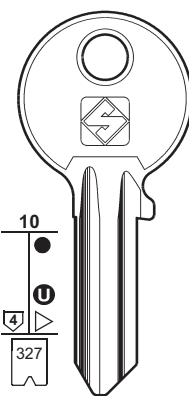

..... 1-2-3-4-5-6



DOBUS - GEVY - TZAFRER



CS16

LOGO

..... 1-2-3-4-5-6

CS25

LOGO

..... 1-2-3-4-5-6

CS30

CS30R

..... 1-2-3-4-5-6

CS34

CS34R

..... 1-2-3-4-5-6

CS36

CS36

..... 1-2-3-4-5-6

CS37

CS37R

..... 1-2-3-4-5-6

CS42

G28D

..... 1-2-3-4-5-6

CS105

CS105

..... 1-2-3-4-5-6

CS43

G16D

..... 1-2-3-4-5-6

CS67

CS67

..... 1-2-3-4-5-6

PER:
FOR:

CISA

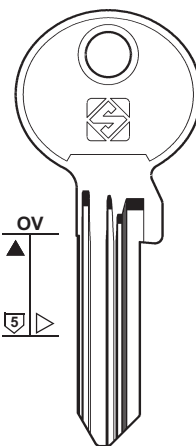
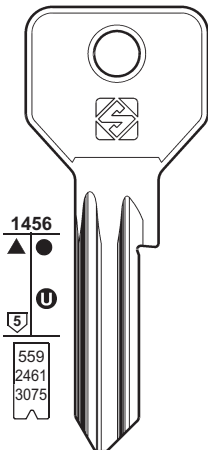
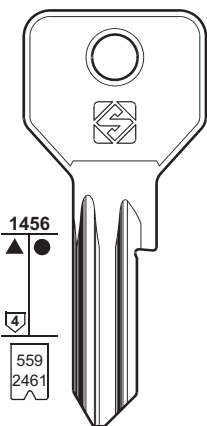
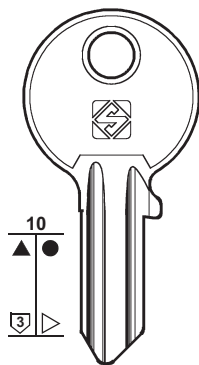

CS4 ●CS4R



CS120

..... 1-2-3-4-5-6-7-8
..... (C 2000) 1-2-3-4-5-6-7-8



⊖ CS119 CS152 ●

..... 0-1-2-3-4-5-6-7-8 R027
..... 1-2-3-4-5-6-7-8
..... (C 2000) 1-2-3-4-5-6-7-8



CS13X ● CS52X ●

BRICARD G14D



●CS66



●CS120R



▲●CS119R



49

PER / FOR

CISA (I)

ABUS

BRICARD

ESLA

JPM

+ ● ABUS (6-7-8-10)

+ ● ALA (13)

PER:
FOR:

CISA

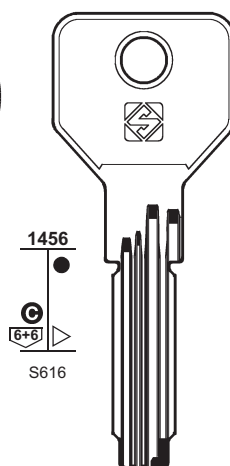
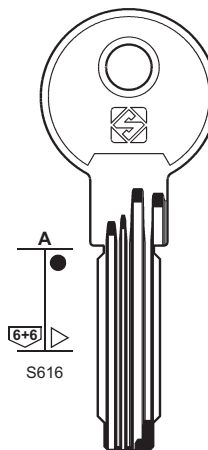
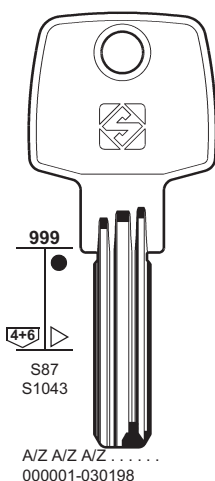
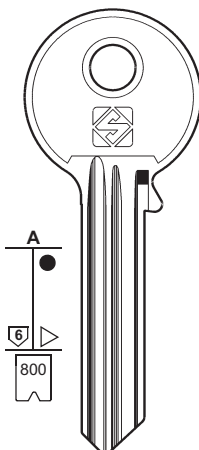
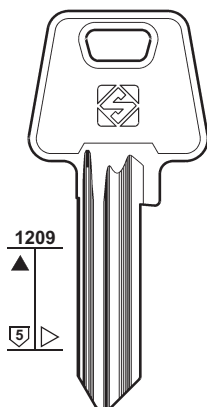

CS61

JPM



CS121

..... 0-1-2-3-4-5-6-7-8-9

ESLA



CS48



ABUS
BRICARD



CS70 (W60)

..... AM 1-38832 AM



ASIX



CS146

..... AM 1-38832 AM



ASIX

PER:
FOR:

CISA

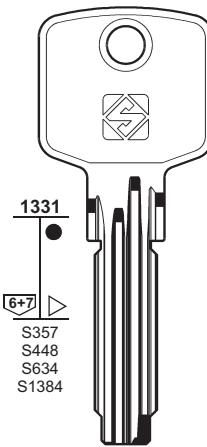

..... (XN008710) 1-11808
..... (XN005710) 1-38832
..... 900001-944826



CS144

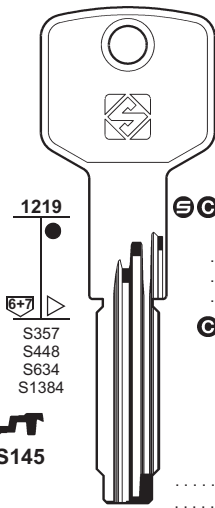

CS145



CS139

..... (XN008710) 1-11808
..... (XN005710) 1-38832



CS62

..... (XN008710) 1-11808
..... (XN005710) 1-38832
..... 900001-944826



CS115

BRICARD



CS141

..... (XN008710) 1-11808
..... (XN005710) 1-38832



CS140

..... (XN008710) 1-11808
..... (XN005710) 1-38832

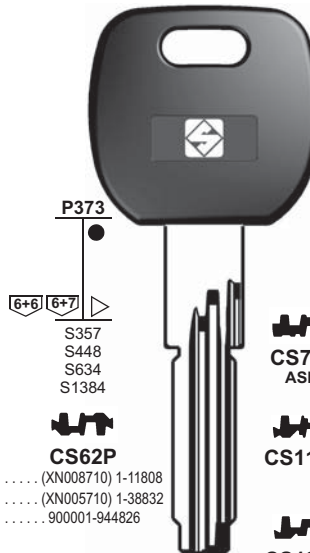

S357
S448
S634
S1384



CS62P

..... (XN008710) 1-11808
..... (XN005710) 1-38832
..... 900001-944826



CS70P
ASIX



CS116P



CS139P



NEW ASTRAL



50

PER / FOR

CISA (I)

- ABUS
- ALA
- BASI
- BATU
- CIBC
- CIGNO
- CITY
- IFAM
- KUNERT
- LOGO
- + ABUS (6-7-8-10)
- + ALA (13)

PER:
FOR:

CISA

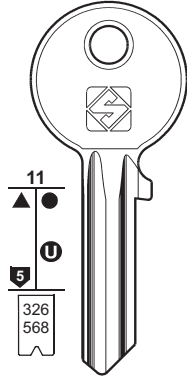

▲● CS21 ●CS21R
..... 1-2-3-4-5-6

⊖ CS7 CS7R
A..... 1-01321
..... 1-2-3-4-5-6



BATU - CIBC
IFAM - KUNERT - LOGO

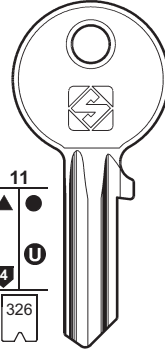

CS6 CS6R ▲●
..... 1-2-3-4-5-6
EA... 1-738



ABUS

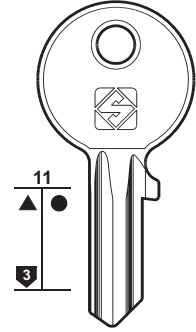

CS5 CS5R ●

LOK 2000
ABUS

PER:
FOR:

CISA

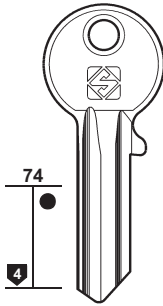

CS22 CS22R
LOGO LOGO

▲● CS8 CS8R



IFAM

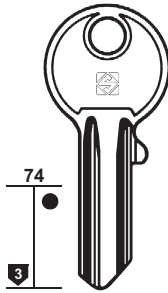

CIGNO

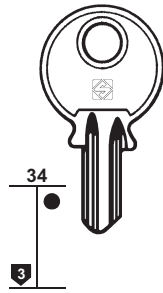

CS9 CS9R CS12 CS12R



ABUS - ALA

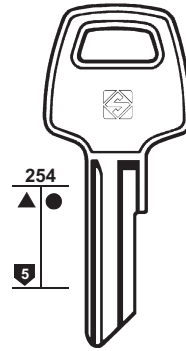

CS10 CS10R ●

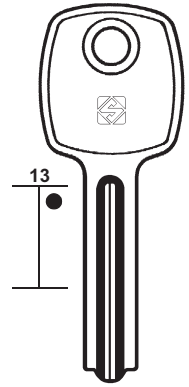

CS11



PER:
FOR:

CISA

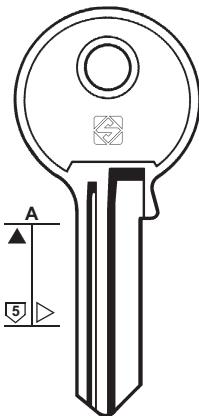

CS33 CS33R



BASI

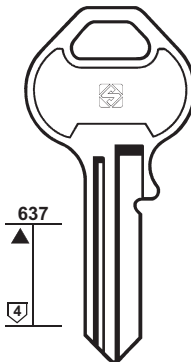

CS32 CS32R



BASI - CITY

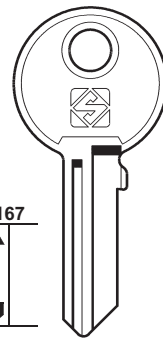

CS19 CS19R



BASI

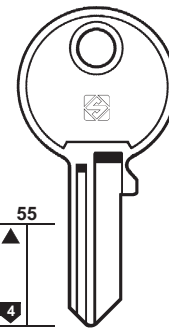

CS26

CS26R



CITY

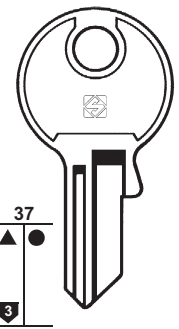









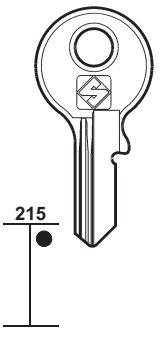
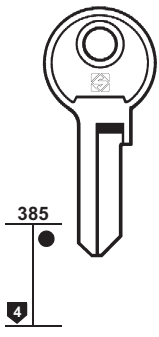
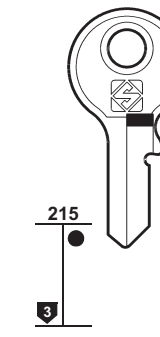
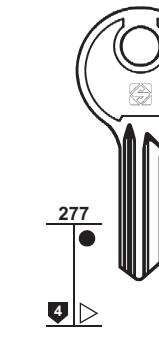
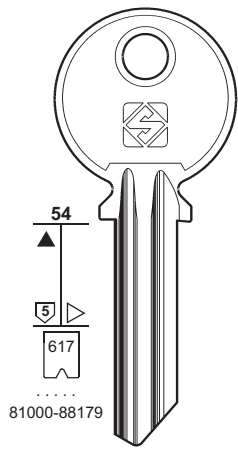





● CS27

CS27R







CITY

CISA				CITY
				
215	385	215	277	54
	4	3	4	5
				617
				81000-88179
				
CS45	CS20	CS23	CS28	CA15
				
CS45R	CS20R	CS23R	CS28R	
				
		BASI - IFAM		



51

PER / FOR
CISA (I)
 BASI
 IFAM
 +  ABUS (6-7-8-10)
 +  ALA (13)

CITY (F)
 ATP
 CAP
 CAVERS
 FO
 PROTEC
 QCP
 SIAM
 SOS
 VIP
 ZENITH
 +  BUGA (36)
 +  CISA (50)
 +  FTH (82)









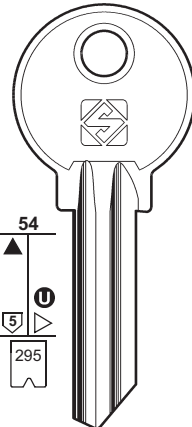
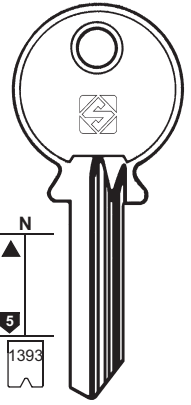

CKS (D)
 YALE (193)

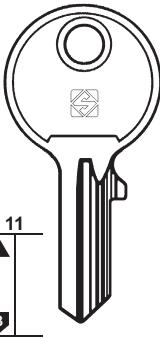



CLAUSOR (E)
 BRABANTIA
 CASH BOX
 ELSET
 +  ME-FA (122)





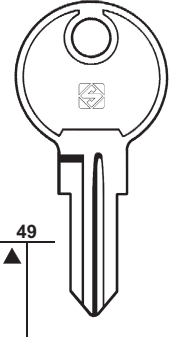
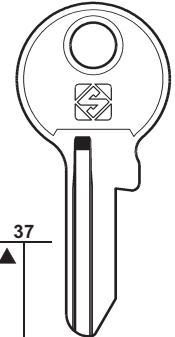





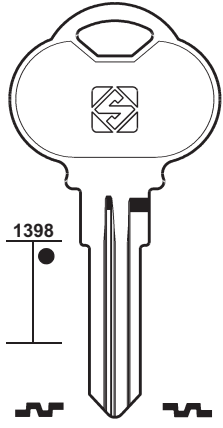
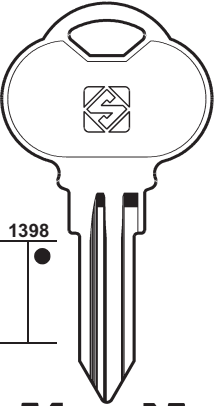

CLUB (USA)

CODEM (F)
 FTH (83)

CODKEY (IL)
 SPIDER (159)

CITY					
					
54	N	274	11	215	
5	5	4	3	3	
295	1393				
					
CA2R	CA2	CA1	CA3	CA4	CA5
	160... 000-999 16... 1000-6288 25001-25075			
ATP - CAP - FO PROTEC - QCP - SIAM SOS - VIP - ZENITH		CAVERS	CAVERS	CAVERS	CAVERS

CLAUSOR	
	
49	37
	
CR2R	CR5R
	
BRABANTIA CASH BOX - ELSET	

CLUB			
			
1398	1398		
			
CLU1	CLU1R	CLU4	CLU4R
			
CLU2	CLU2R	CLU5	CLU5R
			
CLU3	CLU3R		



52

PER / FOR

COLE (USA)
ROYAL

COLE-HERSEE (USA)
YALE (194)

COLL (BY)

COLOMENCA (E)
AGA (11)

COMBA (D)
CES (42)
KFV (105)
TOK-WINKHAUS (170)

CONCEPT (BR)

CORBIN (I)
MERMIER
OAL
POPLOCK

PER:
FOR:

COLE

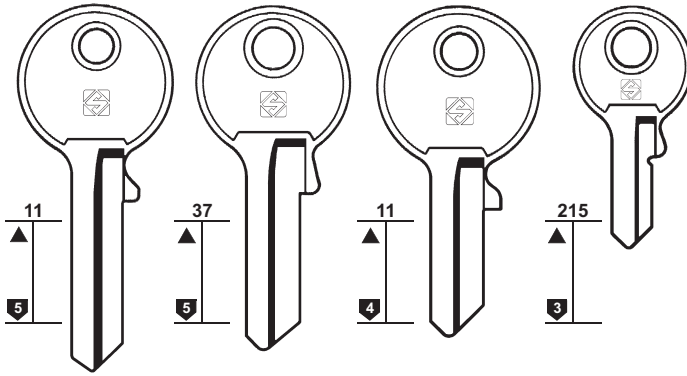

COL1



COL2



ROYAL



COL3



COL4



COLL

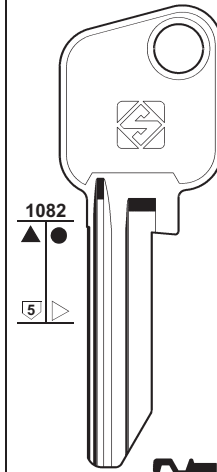

CLL1

CONCEPT

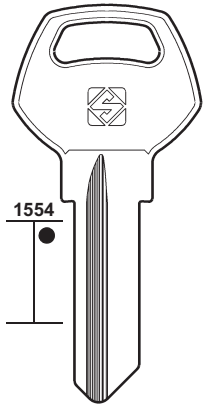

CNP1R

PER:
FOR:

CORBIN (I)

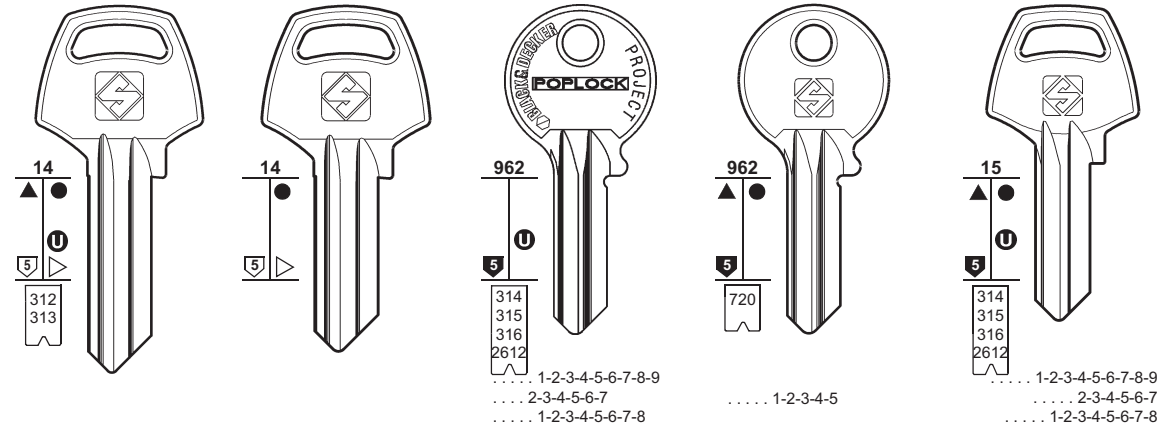

CB1 ▲ CB1R
..... 2-3-4-5-6-7-8-9
..... 1-2-3-4-5-6-7-8-9

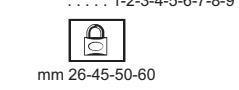

mm 26-45-50-60

MERMIER - OAL

CB2 ▲ CB2R



mm 23

OAL

CB3-OR



POPLOCK

CB80



OAL

CB3 ▲ CB3R ●



mm 21-40

OAL

PER:
FOR:

CORBIN (I)

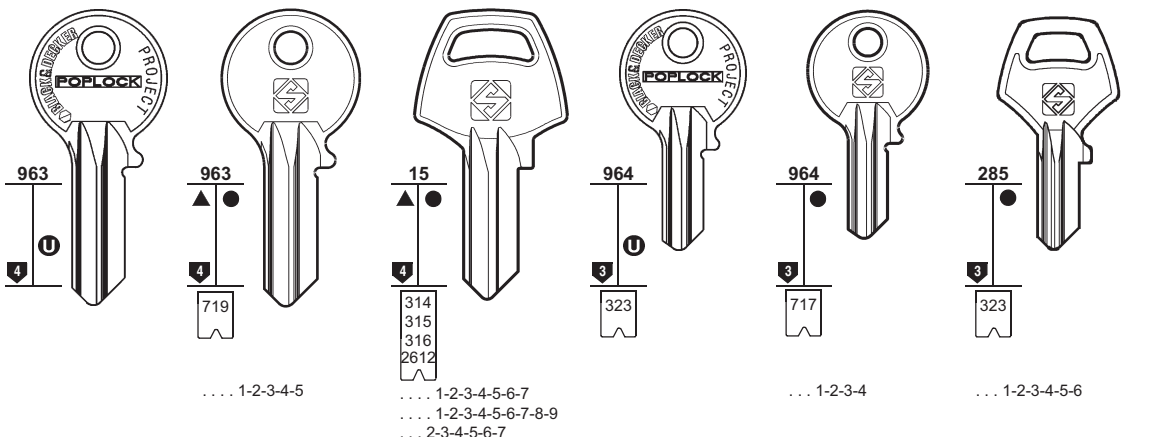

CB4-OR



mm 17,5

POPLOCK

CB81



mm 17,5

POPLOCK

CB4 ▲ CB4R ●



mm 17,5

POPLOCK

CB9-OR



mm 11,5-20-25

POPLOCK

CB79



mm 11,5-20-25

POPLOCK

CB9



mm 11,5-20-25

POPLOCK

PER:
FOR:

CORBIN (I)

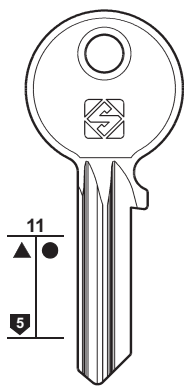

CB85

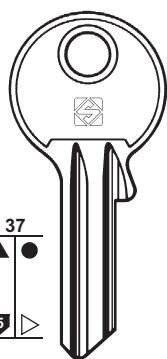

CB15
025

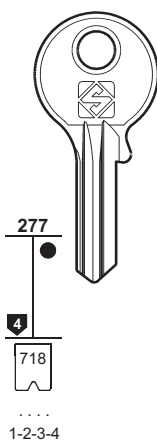

CB70

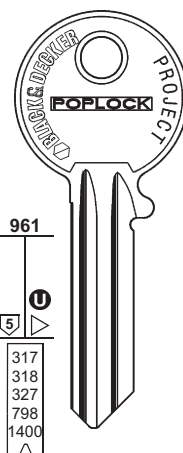

CB6-OR

POPLOCK



53

PER / FOR

CORBIN (I)

ALUNORM
BWS
CRC-CAMBÒA
DOM
ESCO
EURONORM
FEB
HEGO
HESTE
ISSERSTEDT
KAWE
LITTO
MERMIER
MUKRA
NEMEF
NOVOFERM
POPLOCK
STREMLER
SUL
TESIO
THÒNE
VERSCO
WÜRTH
ZECE

PER:
FOR:

CORBIN (I)

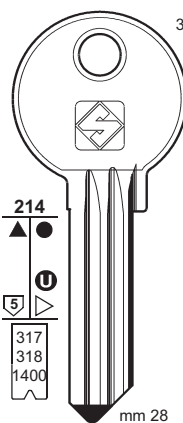

365 **CB6**
ALUNORM
CRC-CAMBÒA
DOM
ESCO
EURONORM
FEB
HEGO
HESTE
ISSERSTEDT
KAWE
LITTO
MERMIER
MUKRA
NEMEF
NOVOFERM
STREMLER
SUL
THÒNE
VERSCO
WÜRTH
ZECE

..... 1-2-3-4-5-6-7-8-9
..... 0-1-2-3-4-5-6-7-8
..... 8-7-6-5-4-3-2-1-0
..... 012345678
..... 123456
DX 123456
..... 123456789
..... 876543210

BWS

CB6R
 CB16
A1
 CB17
 CB19
B1
 CB32
 CB42
 CB43R
 CB78R

CB95R
 CB96R
 CB99R
 CB100R
 CB101R

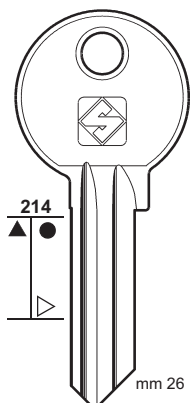

CB5 **CB5R**

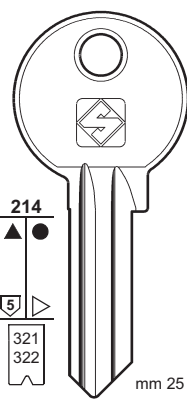

CB8
..... 2-3-4-5-6-7-8
..... 1-2-3-4-5-6-7-8-9

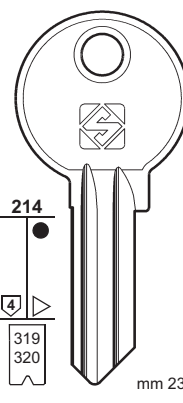

CB7 **CB7R**
..... 1-2-3-4-5-6-7
..... 2-3-4-5-6-7

ESCO - EURONORM
KAWE - MUKRA

PER:
FOR:

CORBIN (I)

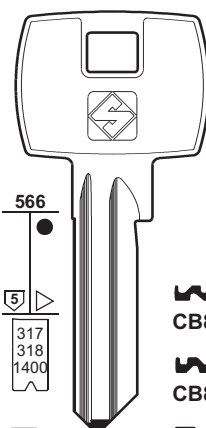

CB89R

CB88R

CB31

CB84
..... 1-2-3-4-5-6-7

CB30

CB30R

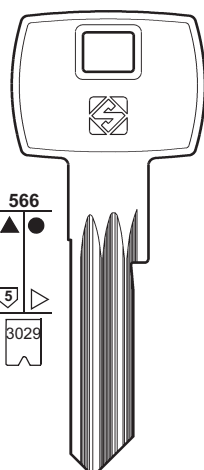

CB90R

CB86
..... 1-2-3-4-5-6-7

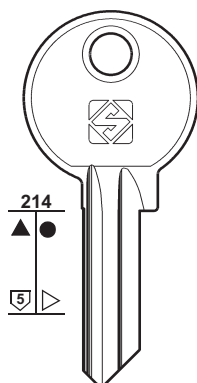

CB21

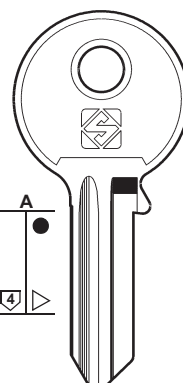

CB83

..... 1-2-3-4-5-6-7-8-9
..... 0-1-2-3-4-5-6-7-8
..... 8-7-6-5-4-3-2-1-0

TESIO





54

PER / FOR

CORBIN (I)

CORBIN (AUS)
LANE

CORBIN (USA)
SKILMANN

PER:
FOR:

CORBIN (I)

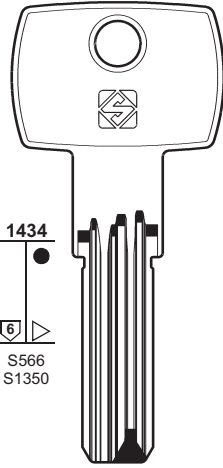

1434
6
S566
S1350



CB87

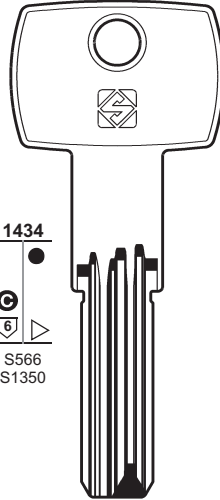

1434
6
S566
S1350



CB97



"Euro Star Plus"

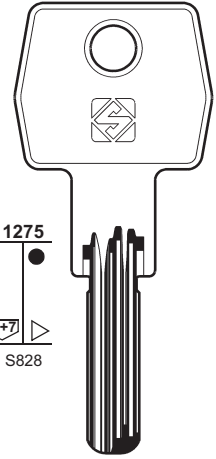

1275
6+7
S828



CB98



PER:
FOR:

CORBIN (USA)

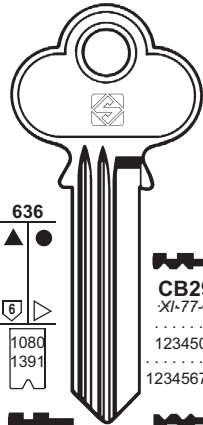

636
6
1080
1391



CB12



CB12R

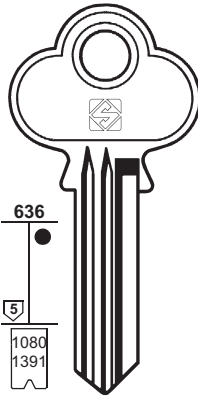

636
5
1080
1391

CB29
XI-77-6
1234506
123456789



CB29R



CB82



CB11

XI-77-5
1234567890



CB11R

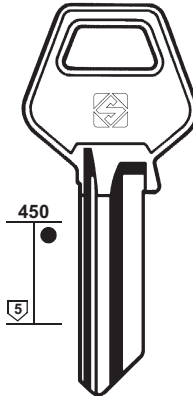

450
5



CB18

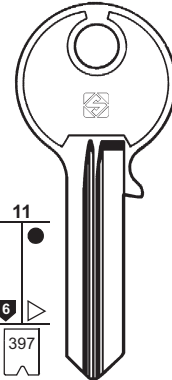

11
6
397



CB28R

4R
0-1-2-3-4-5-6-7-8

9R
0-1-2-3-4-5-6-7-8

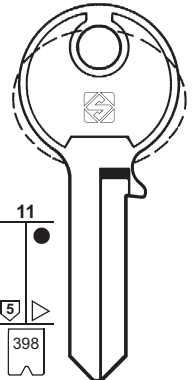

11
5
398



CB38

B4R
0-1-2-3-4-5-6-7-8-9

4T
0-1-2-3-4-5-6-7-8-9



CB37

1234567890



CB39R

1234506
1234567890

SKILMANN

PER:
FOR:

CORBIN (USA)

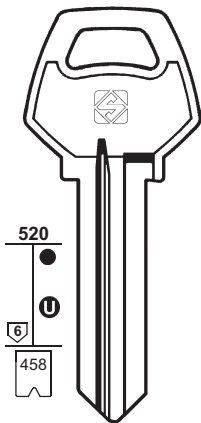

520
6
458

CB34R
1234567

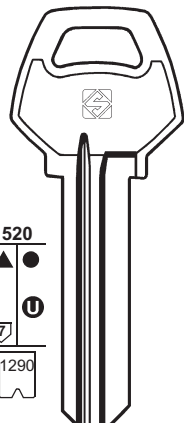

520
7
1290

CB25R
1234506
CB22R

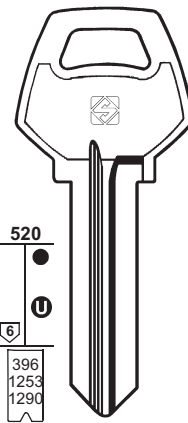

520
6
396
1253
1290

CB40R
1234506
1234567890
M 1234567890
CB23R
1234567890
M 1234567890

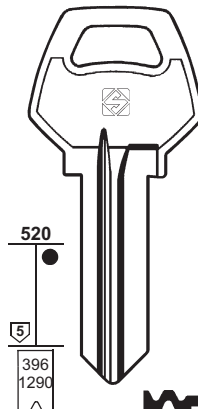

520
5
396
1290

CB26R
1234506
0123456789A
M 1234567890
1234567

CB27R
1234506
1234567890
M 1234567890
CB24R
1234567890
M 1234567890
CB41R
1234567890

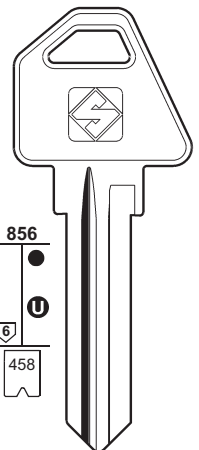

856
6
458

CB44R
1-2-3-4-5-6-7

CORBIN (AUS)
LANE

PER:
FOR:

CORBIN (USA)

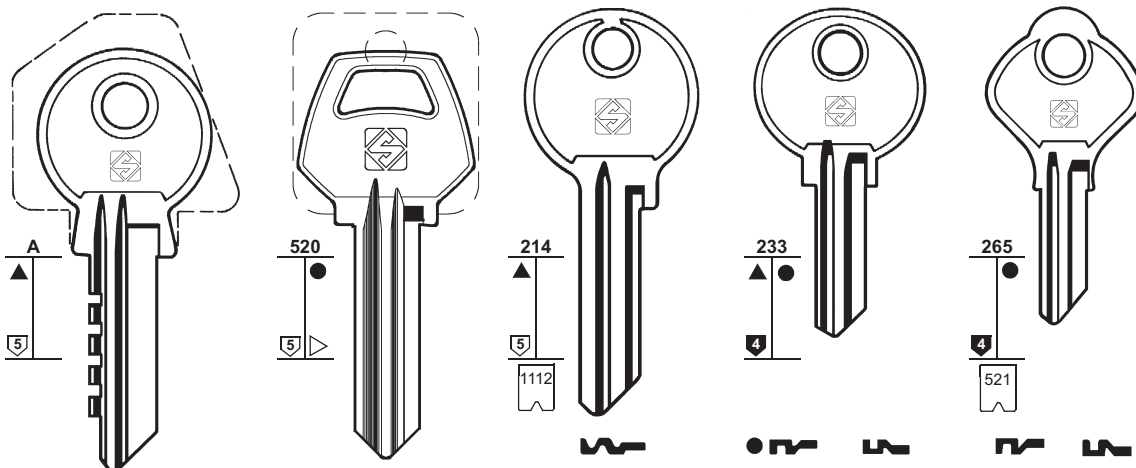

CB20

CB102R

CB10

CB13

CB13R

CB14

CB14R

2A 0-1-2-3-4-5-6-7-8-9
7A 0-1-2-3-4-5-6-7-8-9
8P 0-1-2-3-4-5-6-7-8-9

BGM ...
CAT ...
1-200

EMHART

CHANGE-O-MATIC

CCL



55

PER / FOR

CORBIN (USA)
CCL
CHANGE-O-MATIC
EMHART

CORNI (I)

333
BETA
CIC
EURONORM
FONTAINE
MUL.T.LOCK

CORONA (D)

BAB
BUG
DOCU
GEBRO
ZEISS IKON
+ BAB (26)
+ ZEISS IKON (201)

COTICO (D)

COUILLET (F)
 RICOUARD (146)

PER:
FOR:

CORNI

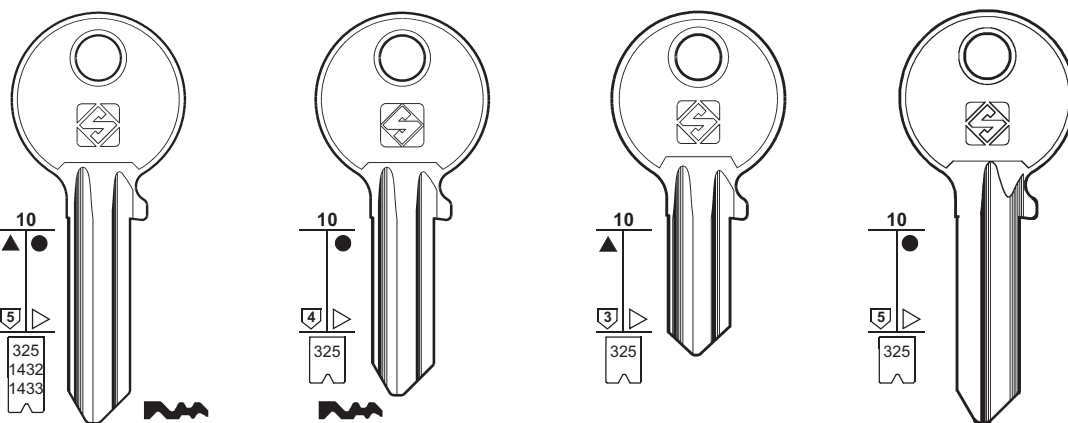

CC5
48 1-1000

CC4 0-1-2-3-4-5-6-7-8-9

CC3 0-1-2-3-4-5-6-7-8-9

CC6R
..... 0-1-2-3-4-5-6-7-8-9

CC2
48 1-1000

CC2R
48 1-1000
..... 28001-29000
..... 80000-80625
..... 85000-86000
..... 86000-87000

CC3 0-1-2-3-4-5-6-7-8-9

CC7 0-1-2-3-4-5-6-7-8-9

333 - BETA - CIC

BETA
EURONORM

BETA

FONTAINE
MUL.T.LOCK

PER:
FOR:

CORNI

CORONA

COTICO

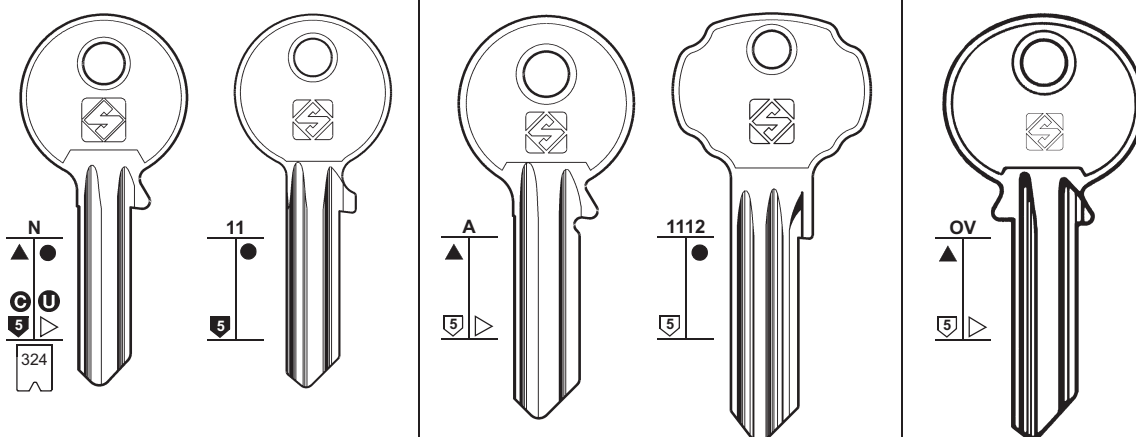

CC1
1-2-3-4-5

CC8

COR1

COR2 **COR2R**

CO1 **CO1R**

BAB - BUG - DOCU
GEBRO - ZEISS IKON



56

PER / FOR

C.R. (I)

CRC-CAMBÔA (P)
CORBIN (53)

CRISTANI (I)
R.C.

CROWN (RC)

CVL (E)

CWS (D)
DOM (61)

DAC (GR)

DAD (F)
DECAEUX
+ FORT (81)
+ L & F (116-117)
+ RONIS (146)
+ VACHETTE (181)

DAF (TR)

PER:
FOR:

C.R.

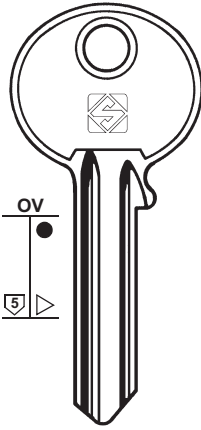

CRISTANI

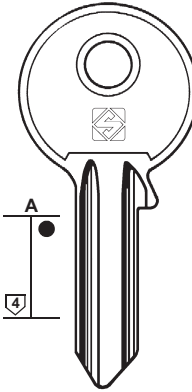
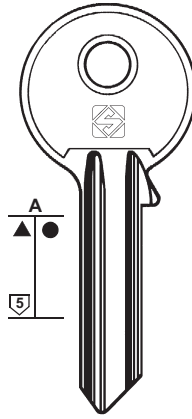

R.C.

CROWN

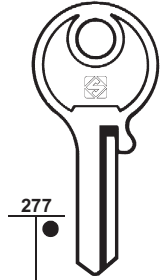

PER:
FOR:

CVL

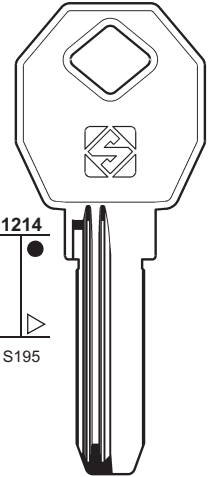
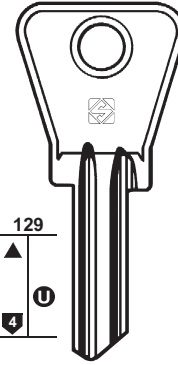
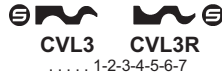
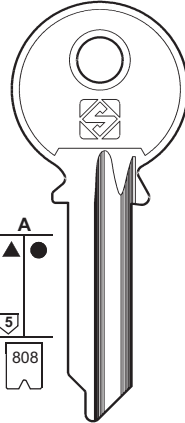
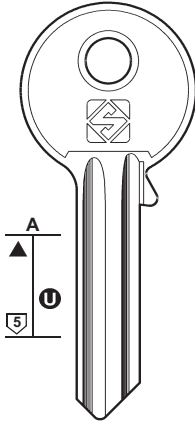

PER:
FOR:

DAC

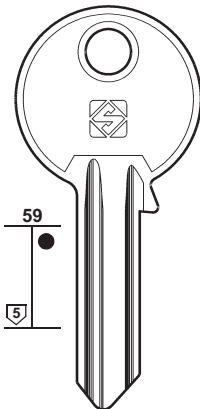

DAD

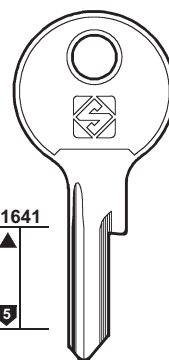
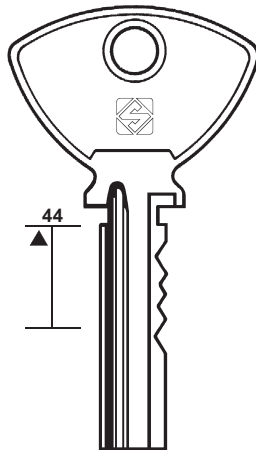

DECAEUX



DAF

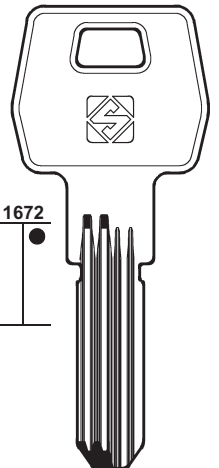
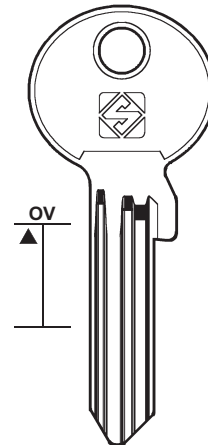

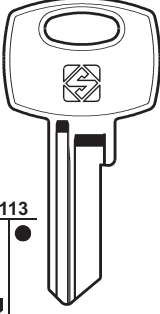
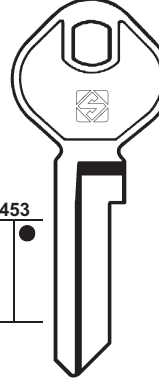
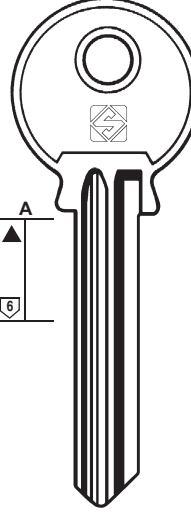
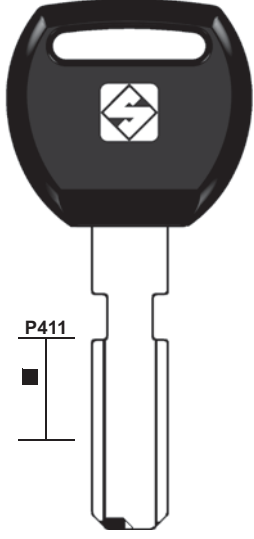
<p>PER: DAIYA</p> <p>FOR:</p>  <p>1113</p> <p>1640</p> <p>DY1 4801-9600 K..... 1-960</p> <p>DY1R 1-4800 S..... 1-960</p>	<p>PER: DALWA</p> <p>FOR:</p>  <p>453</p> <p>DAL1</p> <p>DAL2 DAL2R</p> <p>LIPS</p>	<p>PER: DE ANGELI</p> <p>FOR:</p>  <p>A</p> <p>6</p> <p>DEA2</p>	<p>PER: DEFEND LOCK</p> <p>FOR:</p>  <p>P411</p> <p>DFE1RP</p>
--	--	---	--

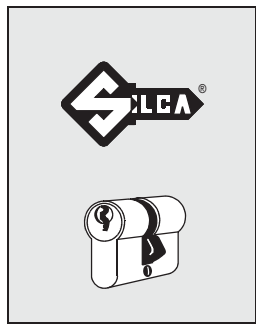

57

PER / FOR
DAIYA (RC)
DALWA (J) LIPS
DAMM (D) 👁️ BKS (30)
DAV (F) 👁️ RONIS (147)
DC (F) 👁️ RONIS (146)
DE ANGELI (I)
DEBEAURAIN (F) 👁️ RONIS (146)
DECAYEUX (F) 👁️ DAD (56) 👁️ DOM (62) 👁️ FORT (81) 👁️ O.NOVOX (136) 👁️ PICARDIE (141) 👁️ RICOUARD (146)
DEF (F) 👁️ KIFERM (106)
DEFEND LOCK (CZ)
DEHA (RC) 👁️ YETI (198-199)
DEKABA (BG) MAUER

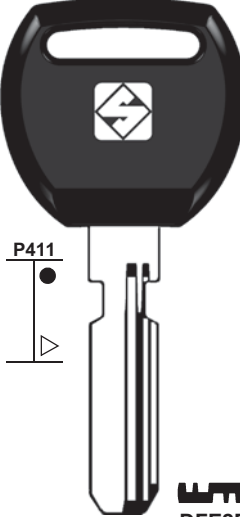
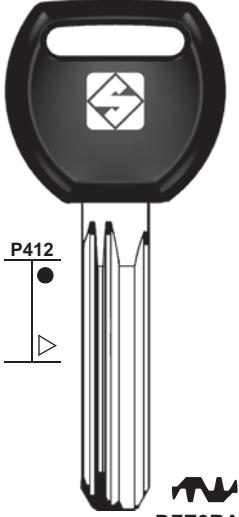
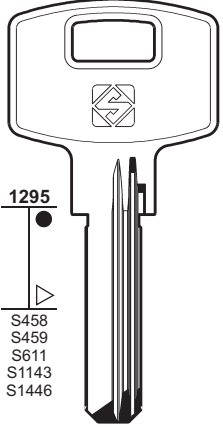
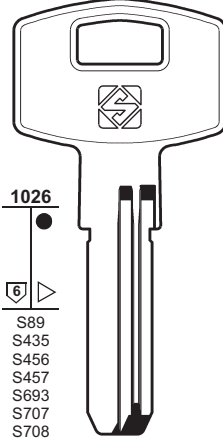
<p>PER: DEFEND LOCK</p> <p>FOR:</p>  <p>P411</p> <p>DFE2P</p>	 <p>P412</p> <p>DFE3RAP</p>	<p>PER: DEKABA</p> <p>FOR:</p>  <p>1295</p> <p>S458 S459 S611 S1143 S1446</p> <p>DK1 00001-85798 000001-028000</p> <p>MAUER</p>	 <p>1026</p> <p>S89 S435 S456 S457 S693 S707 S708 S1144 000016-280006</p> <p>DK3 DK6 E2 E2</p> <p>MAUER</p>
---	--	---	--

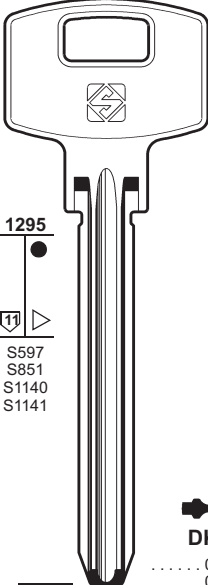
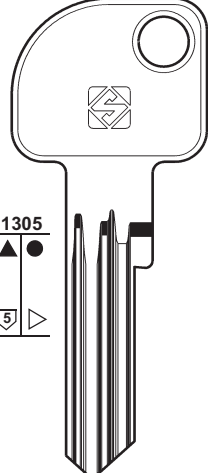
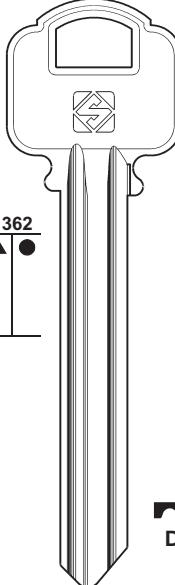
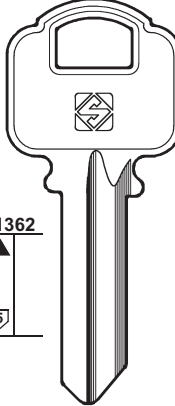
<p>PER: DEKABA</p> <p>FOR:</p>  <p>1295</p> <p>S597 S851 S1140 S1141</p> <p>DK7 000002-111985 000003-129307</p> <p>MAUER</p>	 <p>1305</p> <p>DK5 F</p> <p>MAUER</p>	 <p>1362</p> <p>DK4</p> <p>MAUER</p>	 <p>1362</p> <p>DK8R DK9R</p> <p>MAUER</p>
---	--	--	---



58

PER / FOR

DELCA (GR)
GEVY

DELTA (F)
RONIS (146)

DERLOCHE (F)
RONIS (146)

DESPREZ (F)
GABON (84)
RONIS (146)

DETHLEF (GB)
EURO-LOCKS (71)

DEXTER (I)

DIAMA (F)
FTH (82)

DIAMOND (RC)

PER:
FOR:

DELCA

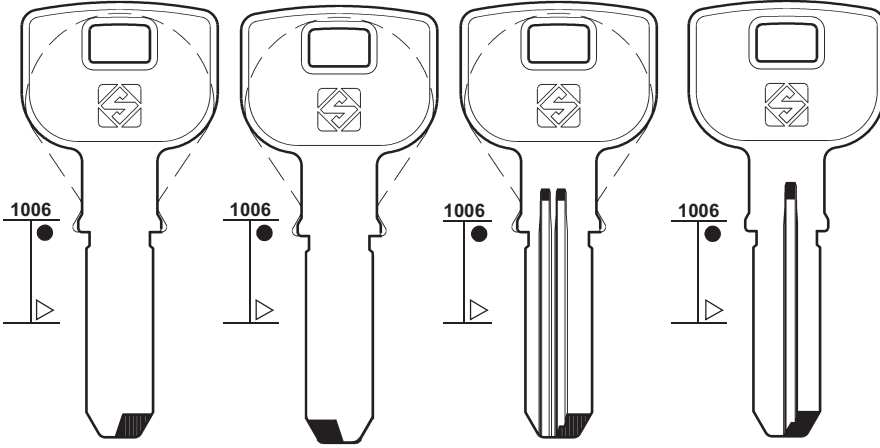

DLC1

DLC1R

DLC2R

DLC3



DEXTER

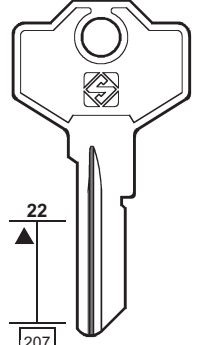

E....
9001-9741

GS4R



PER:
FOR:

DEXTER

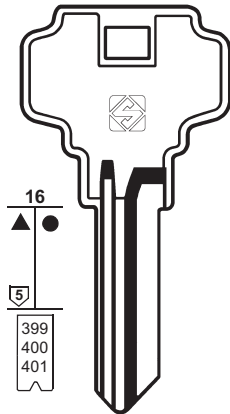

399
400
401

GM
DX18R

B2
DX6R

DX1

DX1R ▲ ●

BM
DX2R

..... 0-1-2-3-4-5-6-7
..... 0-1-2-3-4-5-6-7
..... 0-1-2-3-4-5-6-7-8-9
..... T 0-1-2-3-4-5-6-7-8-9

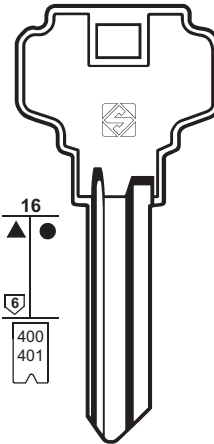

400
401

GM
DX17R ▲

CM
DX15R ▲

D3
DX13R ●

DX3 DX3R

B1
DX4R ▲

..... 0-1-2-3-4-5-6-7
..... 0-1-2-3-4-5-6-7-8-9
..... T 0-1-2-3-4-5-6-7-8-9

PER:
FOR:

DIAMOND

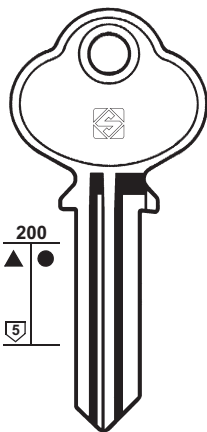

DN2

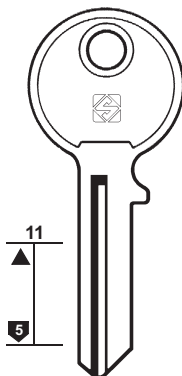

DN3

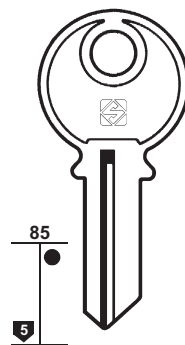

DN1

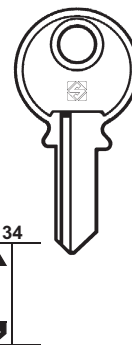

DN9R

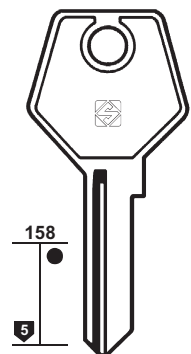

DN4



PER:
FOR:

DIAMOND

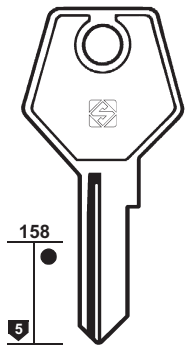

DN5

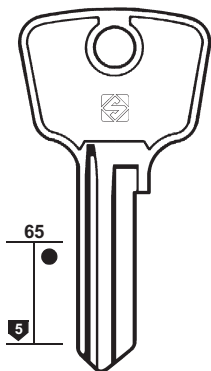

DN7

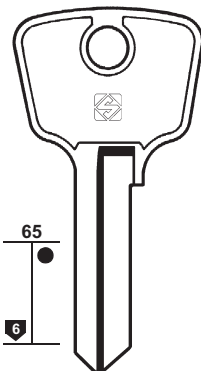

DN6

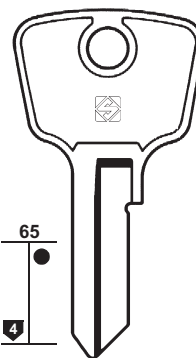

DN8



59

PER / FOR

DIAMOND (RC)

DIERRE (D)
+ WILKA (191)

DIFA (DK)
+ RUKO (148)

DIMITROVGRAD
(RUS)

DISQUIN (F)
+ TOK-WINKHAUS (169)

DLP
(D. LA PORTE) (D)
+ LA PORTE (110)

DNEPROPETROVSK
(UA)
FIMANEVSKI

DNS (GB)
+ EAGLE (67)

DOBLINA (D)

PER:
FOR:

DIERRE

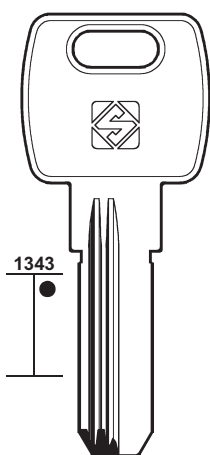

DIR1R



DIMITROVGRAD

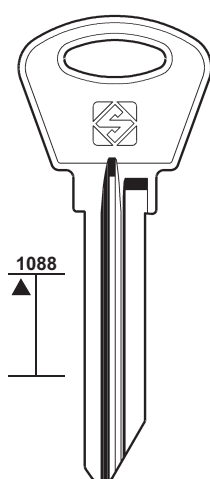

DMT1R

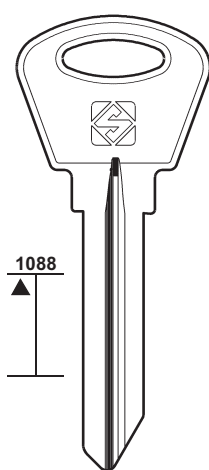

RUS3R



DMT2R

DLP (D. LA PORTE)

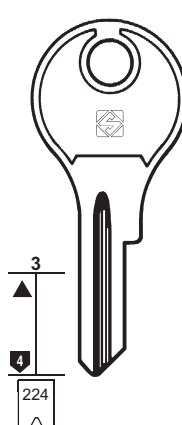

DL1R

... 2501-2550

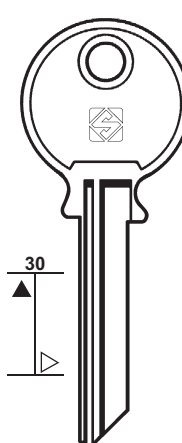

LAP3

PER:
FOR:

DLP (D. LA PORTE)

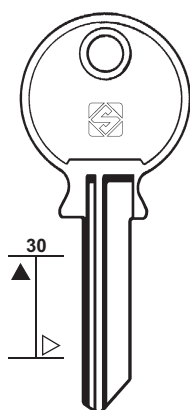

LAP2

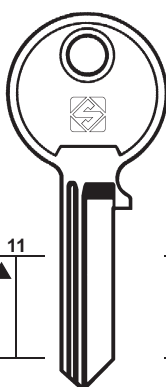

DL3

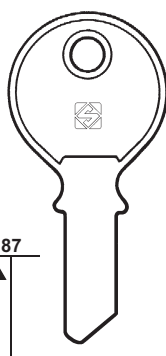

DL2

DNEPROPETROVSK

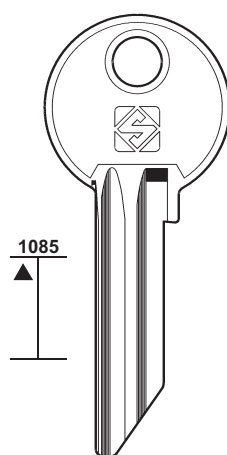

FMK1

FIMANEVSKI

DOBLINA

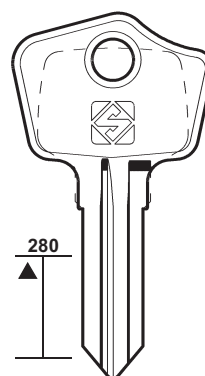

DB60



60

PER / FOR

DOBLINA (D)

DOBUS (D)
CISA (48)

DOCO (D)
CORONA (55)

DOFIN (F)
GLOBE (87)

DOM (D)
LISTA
NOBO
+ CORBIN (52)
+ EMR (69)
+ MLM (127)
+ STUV (163)

PER:
FOR:

DOBLINA

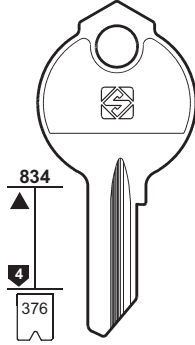

... 201-626

DB1 35 ...	DB1R 34 ...	DB12 22 ...	DB12R 23 ...	DB28 120 ...	DB28R 121 ...	DB44 H ...	DB44R G ...
DB2 U ...	DB2R V ...	DB13 25 ...	DB13R 24 ...	DB29 122 ...	DB29R 123 ...	DB45 L ...	DB45R K ...
DB3 2 ...	DB3R 1 ...	DB14 27 ...	DB14R 26 ...	DB30 125 ...	DB30R 124 ...	DB46 M ...	DB46R N ...
DB4 3 ...	DB4R 4 ...	DB15 29 ...	DB15R 28 ...	DB31 130 ...	DB31R 131 ...	DB47 P ...	DB47R R ...
DB5 6 ...	DB5R 5 ...	DB16 31 ...	DB16R 30 ...	DB32 132 ...	DB32R 133 ...	DB48 S ...	DB48R T ...
DB6 8 ...	DB6R 7 ...	DB17 32 ...	DB17R 33 ...	DB33 134 ...	DB33R 135 ...	DB49 Y ...	DB49R Z ...
DB7 11 ...	DB7R 12 ...	DB18 36 ...	DB18R 37 ...	DB34 136 ...	DB34R 137 ...	DB50 1Z ...	DB50R 1Y ...
DB8 14 ...	DB8R 13 ...	DB19 39 ...	DB19R 38 ...	DB35 138 ...	DB35R 139 ...	DB51 1A ...	DB51R 1B ...
DB9 15 ...	DB9R 16 ...	DB20 40 ...	DB20R 41 ...	DB36 141 ...	DB36R 140 ...	DB53 1E ...	DB53R 1F ...
DB10 17 ...	DB10R 18 ...	DB21 42 ...	DB21R 43 ...	DB37 142 ...	DB37R 143 ...	DB54 1H ...	DB54R 1G ...
DB11 20 ...	DB11R 21 ...	DB22 44 ...	DB22R 45 ...	DB38 145 ...	DB38R 144 ...	DB55 1K ...	DB55R 1L ...
		DB23 47 ...	DB23R 46 ...	DB39 147 ...	DB39R 146 ...	DB56 1M ...	DB56R 1N ...
		DB24 48 ...	DB24R 49 ...	DB40 148 ...	DB40R 149 ...	DB57 1R ...	DB57R 1P ...
		DB25 51 ...	DB25R 50 ...	DB41 B ...	DB41R A ...	DB58 1T ...	DB58R 1S ...
		DB26 53 ...	DB26R 52 ...	DB42 D ...	DB42R C ...	DB59 1X ...	DB59R 1W ...
		DB27 54 ...	DB27R 55 ...	DB43 F ...	DB43R E ...		

PER:
FOR:

DOM

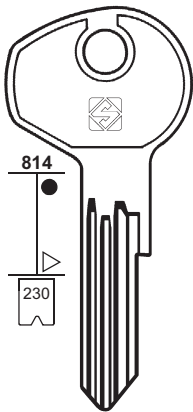

ZDDM ... 101-150
7F ... (KN)
1F ... 501-513
YSNR ... 201-275
YVLF ... (KN) 201-275
YZFZ ... (KN) 201-275

DM106

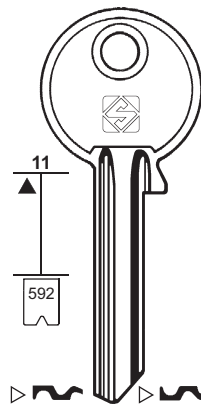

DM13 4 DM13R 3

DM96 1E ... 1-160

DM104R KNK

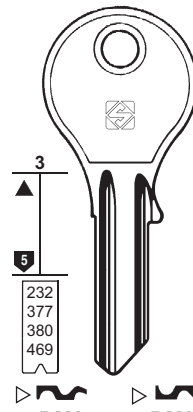

DM2 3 DM2R 4
EV ... 1-2840
GS ... 1-1000
FT ... 1-1000
CQ ... 301-400
... 1-1000

DM62 DM62R



NOBO

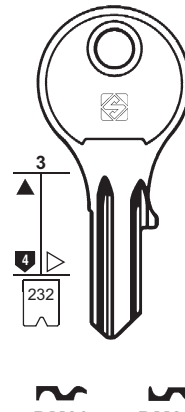

DM23 29 DM23R 3
CL ... 501-750
ED ... 1-380
EG ... 1-250



LISTA

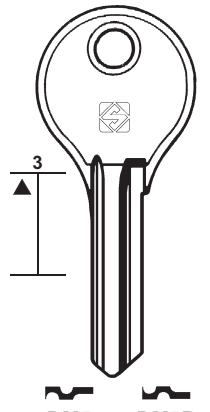

DM5 DM5R



PER:
FOR:

DOM

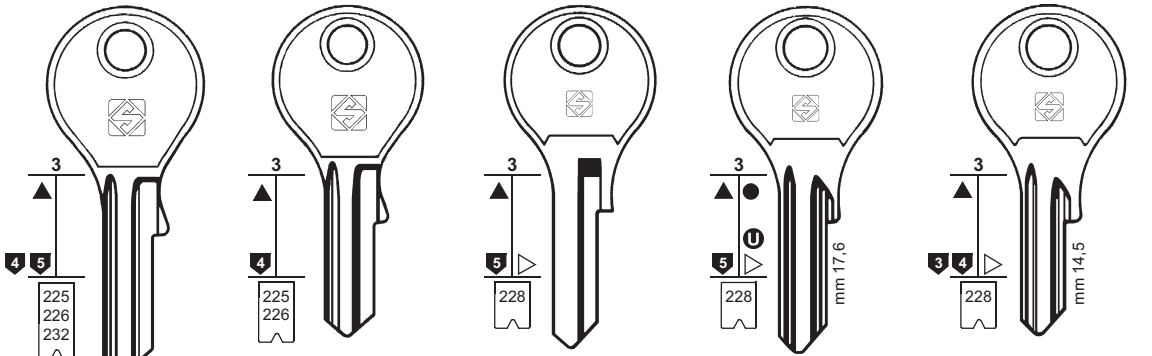

DM4 80138-80748
..... 80761-83242
DN ... 1-120

DM4R

DM6 80138-80748
..... 80761-83242

DM6R 80138-80748
GP ... 1-250
C ... 1001-1200
CL ... 1-250
C ... 1301-1500

DM39 80138-80748
..... 80761-83242

DM39R 6E ... 1-205
7E ... 269-473

DM8 2D ... 1-222
5A ... 1-2600
9A ... 1-5200
W ... 1-50
1D ... 601-654
2W ... 1-50

DM8R ▲

DM10 2A ... 1-34
DB ... 1-148
CF ... 1-140
3A ... 1-82
4A ... 1-482
1D ... 501-560
1D ... 1-57
FG ... 1-615
FS ... 1-60

DM10R 1D ... 58-114
2A ... 35-68

DM61 GS ... 1-1000
... 1-1000

DM61R

BARRO - IDEAL - TM

CHRIST

EAO - SWISSTAC

BTV - DECAEUX
HÄFELE - HEKNA
HUWIL - METEOR
MLM - RUKA
SCHLEGEL - STS

CWS - HÄFELE
HEKNA - HUWIL
MENOVA - METEOR
MLM - RUKA
SINJET



61

PER / FOR

DOM (D)
BARRO
BTV
CHRIST
CWS
DECAEUX
EAO
FLAMBO
GEWIRU
HÄFELE
HEKNA
HUWIL
IDEAL
MENOVA
METEOR
MLM
NOBO
PEROHAUS
RAFI
RUKA
SCHLEGEL
SINJET
STS
SWISSTAC
TM

+ CORBIN (52)
+ EMR (69)
+ MLM (127)
+ STUV (163)

PER:
FOR:

DOM

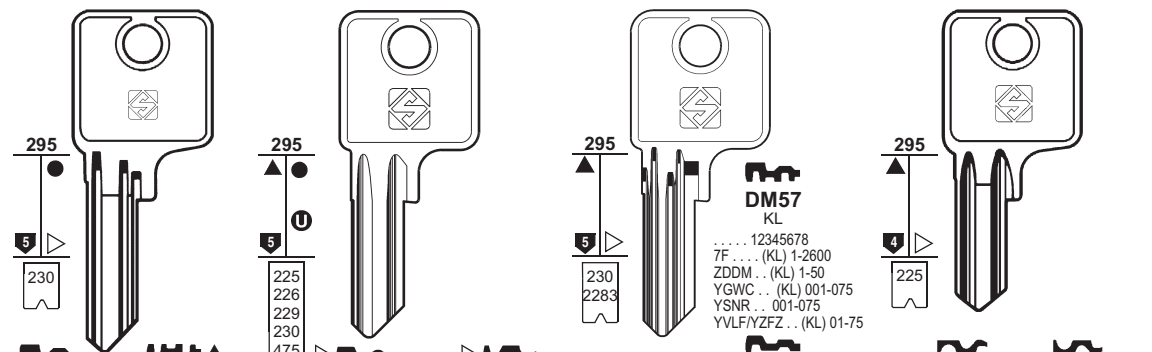

DM41 80138-80748
..... 80761-83242

DM41R

DM16 DC ... 1-1800
K ... 1-50
GD ... 1-1800
GZ ... 1-1800
3E ... 1-350
2C ... 1-2600

DM16R

DM57 KL
..... 12345678
7F ... (KL) 1-2600
ZDDM ... (KL) 1-50
YGWC ... (KL) 001-075
YSNR ... 001-075
YVLF/YZFX ... (KL) 01-75

DM102

DM37 80138-80748
..... 80761-83242

DM37R

DM38

DM52 ZDDM ... 51-100
7F ... (KM) 5201-5205
YSNR ... 001-075
YVLF/YZFX ... (KL) 01-75

DM101

DM11 VN 80138-80748
..... 80761-83242

DM112 YSNR ... (WS) 2701-2775
YZFX ... (WS) 2701-2775

DM113 WL 80138-80748
..... 80761-83242

DM137 YSNR ... (WL) 2701-2775
YZFX ... (WL) 2701-2775

DM19 DN ... 1-120
..... 80138-80748
..... 80761-83242

DM19R DN ... 1-120
..... 80138-80748
..... 80761-83242

DM110 2D ... 1-222
5A ... 1-2600
9A ... 1-5200
W ... 1-50

DM116

DM149

DM36 C ... 1001-1200
CL ... 1-250
GP ... 1-250
C ... 1301-1500

DM36R C ... 1001-1200
CL ... 1-250
GP ... 1-250
C ... 1301-1500

FLAMBO - HEKNA
NOBO - PEROHAUS

GEWIRU

PER:
FOR:

DOM

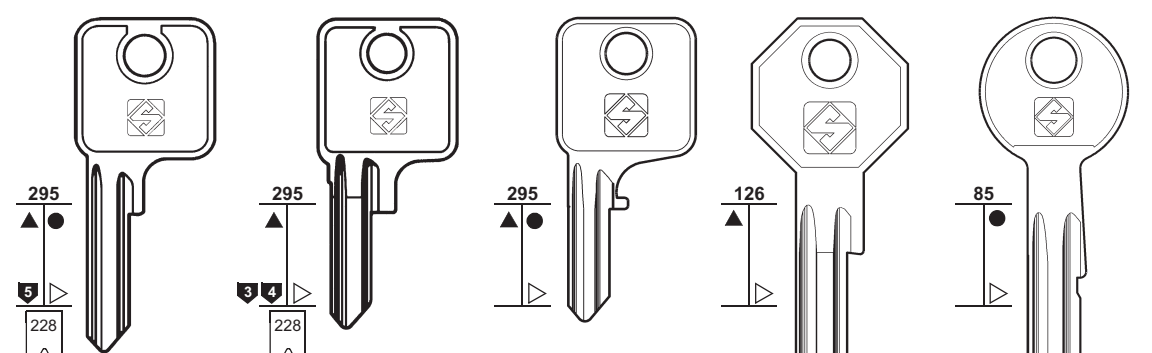

DM63 2D ... 1-222
5A ... 1-2600
9A ... 1-5200
W ... 1-50

DM63R ▲

DM34 CF ... 1-140
DB ... 1-148
2A ... 1-34
4A ... 1-482
1D ... 1-57
FG ... 1-615
3A ... 1-82
1D ... 501-560

DM34R 1D ... 58-114
2A ... 35-68

DM110

DM116

DM114

BMW

RAFI



62

PER / FOR

DOM (D)
 CORBIN
 DYES
 EMHART
 FORTSCHRITT
 HÄFELE
 HÖHRMANN
 LISTA
 MAQUET
 MARCO
 MIPPART
 MLM
 STEIGA
 STS
 STUV
 VARIO
 VIKI
 VOKO

- + CORBIN (52)
- + EMR (69)
- + MLM (127)
- + STUV (163)

PER:
FOR:

DOM

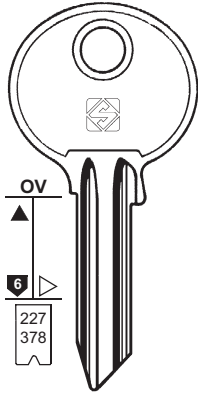

DM7
FA ... 1-3948
CD ... 1-500

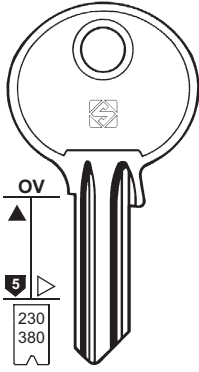

DM35R

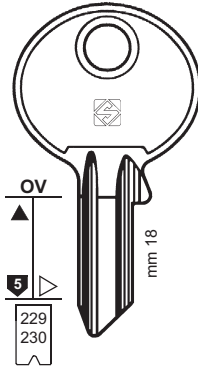

DM25
EV ... 1-2840
4C ... 1-3000



DM48
2C ... 1-2600
DC ... 1-1800
3E ... 1-350
GD ... 1-1800
GZ ... 1-1800
1C ... 1-363
TB ... 1-1796

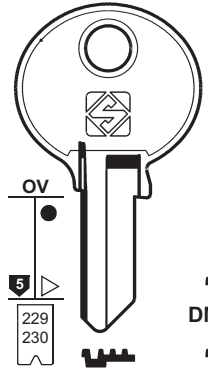

DM28

DM11
 2C ... 1-2600
 DC ... 1-1800
 3E ... 1-350
 GD ... 1-1800
 GZ ... 1-1800
 1C ... 1-363
 TB ... 1-1796
 YSNR ... (VN) 1201-1275
 YSNR ... (WN) 2201-2275
 YZfZ ... (VN) 1201-1275



DM123-6

DM123-1

DM123-7

DM123-2

DM123-8

DM123-3

DM123-9

DM123-4

DM123-10

DYES - FORTSCHRITT - HÄFELE
 LISTA - MAQUET - MARCO
 MIPPART - MLM - VOKO

VARIO

HÖHRMANN

PER:
FOR:

DOM

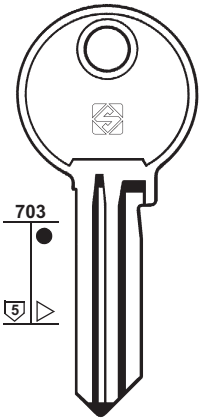

DM98R
E

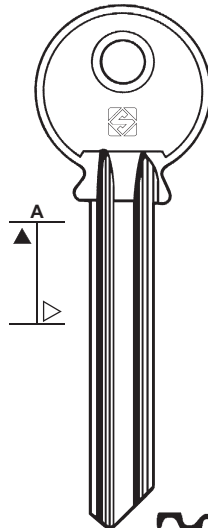

DM32

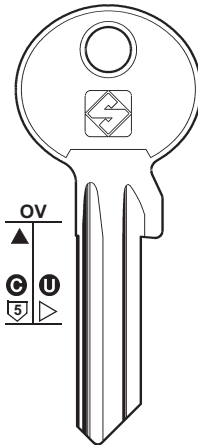

DM3X

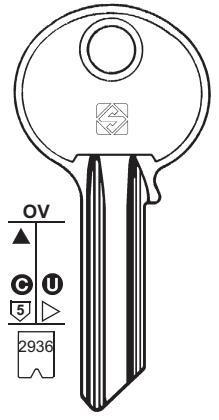

DM3



DM105R

..... 01234567

STEIGA
STUV - VIKI

PER:
FOR:

DOM

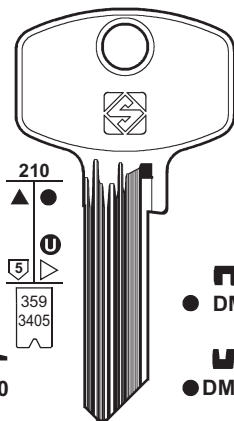

DM150



DM20
..... PT 129893-130092



DM14

0-1-2-3-4-5-6-7-8-9
..... PT
129893-130092



DM103



DM141R



DM97R



DM119

CORBIN
..... 0123456789
..... 0123456789

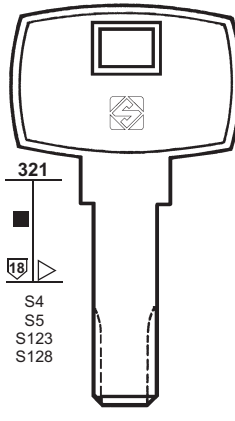

DM22



CORBIN - EMHART



DM22TVP



DM22TV5



DM22TV10



DM22TV4



DM22TV9



DM22TV3



DM22TV8



DM22TV2



DM22TV7



DM22TV1



DM22TV6

PER:
FOR:

DOM

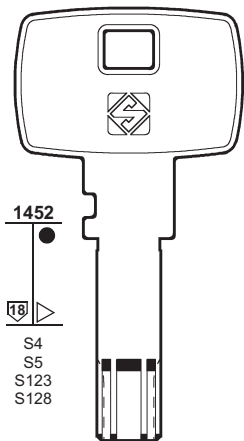

DM22TVPX **DM22TV5X**

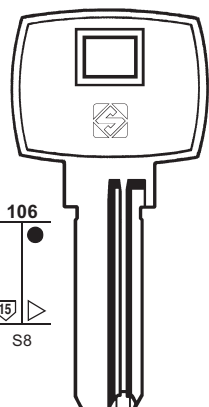

DM24 **DM64**
IX5



DM118

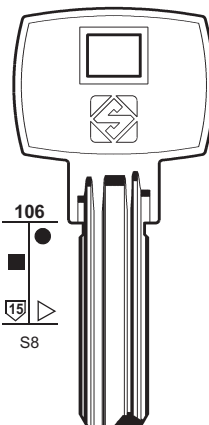

DM120 **DM122**



63

PER / FOR

DOM (D)

ASPA
CORBIN
EMHART
IR
LAPERCHE
MOREAUX
NOBO
STS

- + CORBIN (52)
- + EMR (69)
- + MLM (127)
- + STUV (163)

PER:
FOR:

DOM

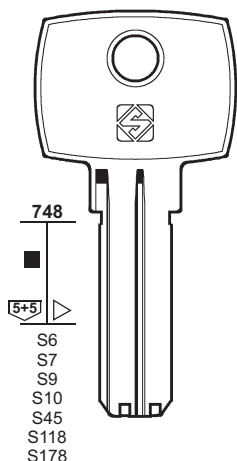

DM49 **DM53**

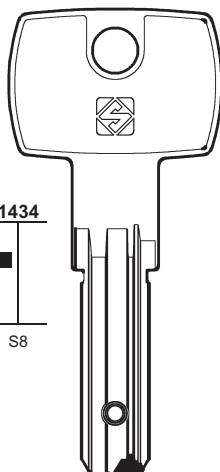

DM139 **DM145**
IX5

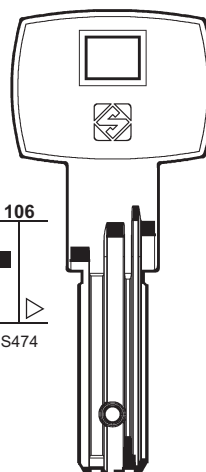

DM144
IX6



PER:
FOR:

DOM

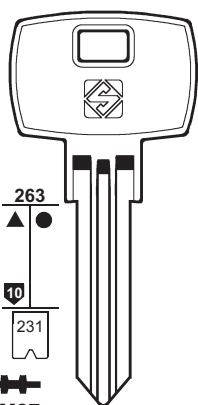

DM27
1H ... 1-4088
3H ... 1-600

DM17 **DM17R**

1H ... 1-4088
2H ... 1-2088
3H ... 1-600

ASPA

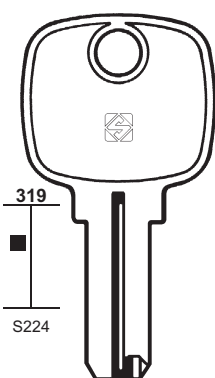

S224

DM21
..... 0-1-2-3-4-5



MOREAUX

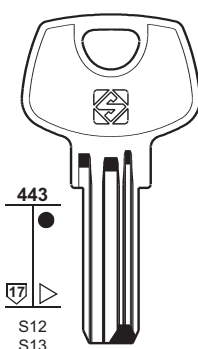

S12
S13

DM138

DM55
2Y



ALARM

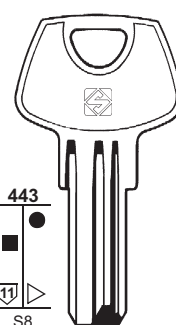

S8
S11

DM128

DM58



ALARM



64

PER / FOR

DOM (D)

PER:
FOR:

DOM

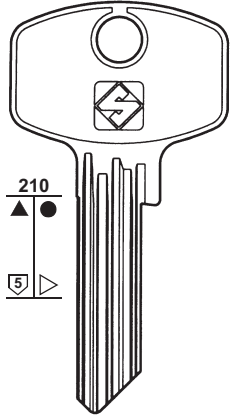

DM40
L



DM44
M



DM18R
C



DM42
D



DM29
P



DM43
U



DM40R
L



DM44R
M



DM18
C



DM42R
D



DM29R
P



DM43R
U



DM67



DM50



DM67R



DM66



DM68



DM69



DM70



DM74



DM60



DM66R



DM68R



DM69R



DM70R



DM74R



DM47
Q



DM46
R



DM26
S



DM47R
Q



DM46R
R



DM26R
S



DM71



DM72



DM73



DM75



DM115



DM71R



DM72R



DM73R



DM75R



DM115R



DM45
T



DM45R
T



DM33R



DM12-1



DM12-10



DM12-19



DM12-28



DM12R-12



DM12-37



DM12-46



DM12-2



DM12-11



DM12-20



DM12-29



DM12R-13



DM12-38



DM12-47



DM12-00



DM12-3



DM12-12



DM12-21



DM12-30



DM12R-16



DM12-39



DM12-4



DM12-13



DM12-22



DM12-31



DM12R-19



DM12-40



DM12-5



DM12-14



DM12-23



DM12-32



DM12R-31



DM12-41



DM12R-00



DM12-6



DM12-15



DM12-24



DM12-33



DM12R-32



DM12-42



DM12-7



DM12-16



DM12-25



DM12-34



DM12R-34



DM12-43



DM12-8



DM12-17



DM12-26



DM12-35



DM12R-35



DM12-44



DM12-9



DM12-18



DM12-27



DM12-36



DM12R-36



DM12-45

PER:
FOR:

DOM

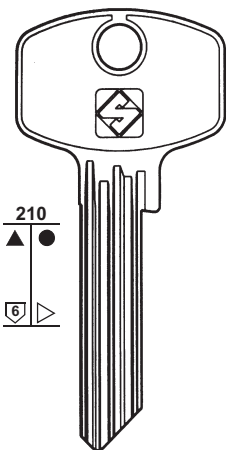

65

PER / FOR

DOM (D)



66

PER / FOR

DOMINION (USA)
PETERBORO
+ **ARROW** (18)

DOMUS (I)
+ **CAS-CISMA** (40)

DOMUS (GR)

PER:
FOR:

DOMINION

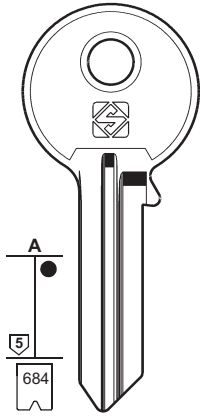

DO1R

1-2-3-4-5-6-7-8-9
PETERBORO

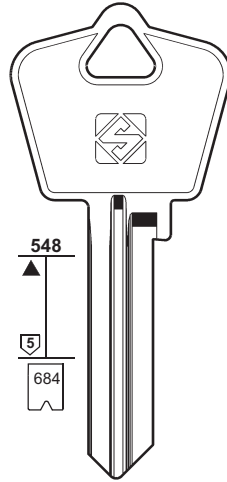

DO2R

1-2-3-4-5-6-7-8-9

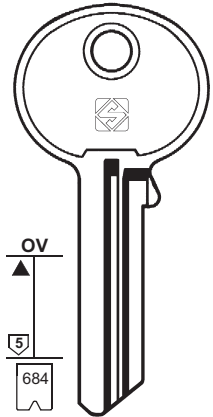

DO6

1-2-3-4-5-6-7-8-9

PER:
FOR:

DOMINION

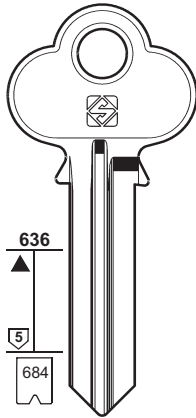

DO10

1-2-3-4-5-6-7-8-9

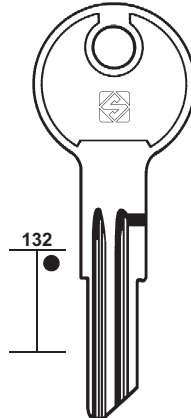

DO11

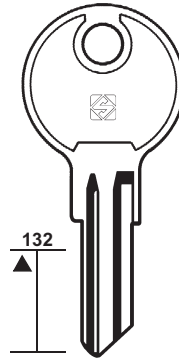

DO12

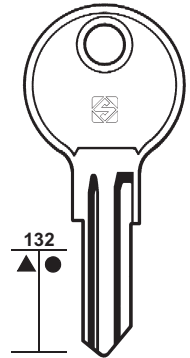

DO13



PER:
FOR:

DOMUS (I)

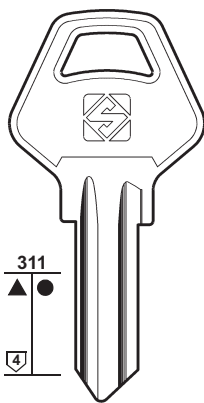

DS4

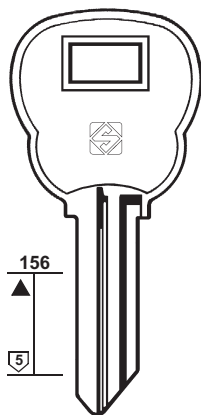

DS1



DS1R



DS2

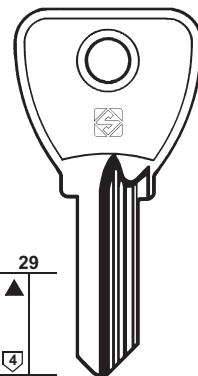

DS3R

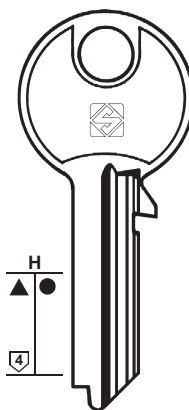

DS5R

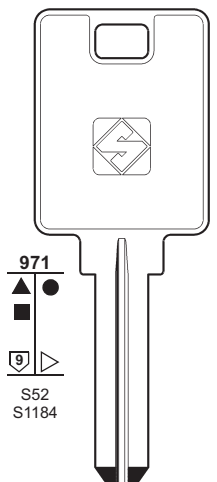







DS6

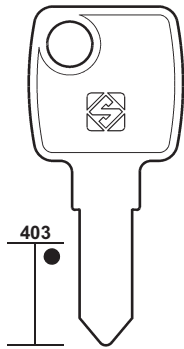
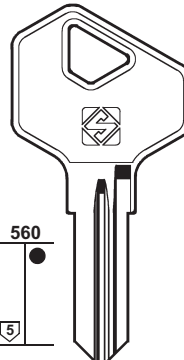
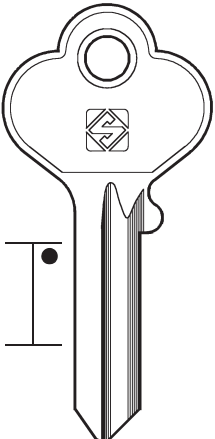
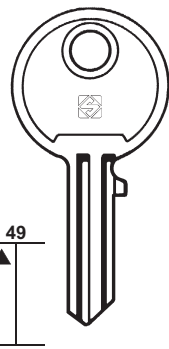

DS7







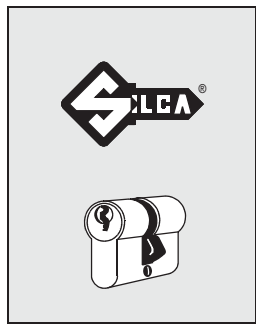



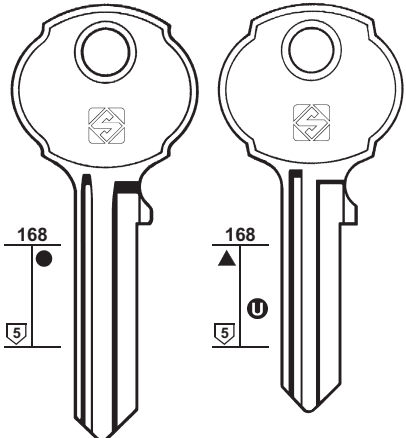
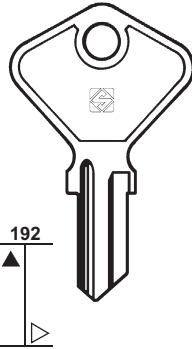
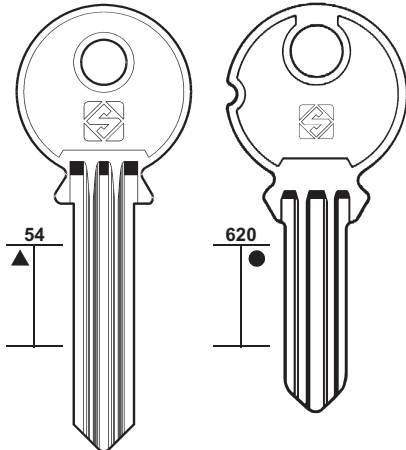







DOMUS (GR)



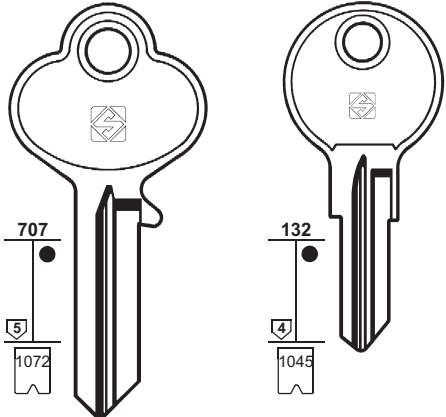
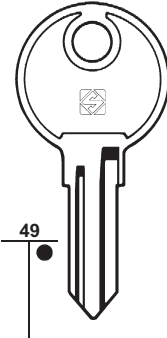
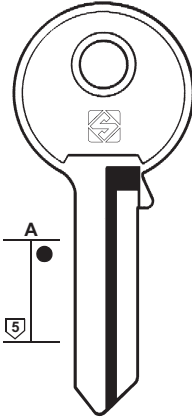



PER: FOR:	DONG HWA	DORIC	DORSET	DOUBLE ARROWS
	 403	 560 5		 49
	 DOW1R	 DRC1	 DRS1R	 DW1 



67

PER: FOR:	DOUBLE CIRCLE	DUPLOMATIC	EAG
	 168 5	 192	 54 620
	 DCR1	 DP1	 EA1
	 DCR2	 DP1R	 EA2
	 TRI-CIRCLE		 EA3  EA4

PER: FOR:	EAGLE	EAST	ECM
	 707 5 1072	 49	 A 5
	 EG1	 EAS1	 ECM1
	 EG2		 ECM1R
	 EG2R		
 1-2-3-4-5-6-7-8-9-0		
	DNS - HARLOCK - LORI		

PER / FOR
DONG HWA (RC)
DORIC (AUS)
DORMA (D)  WILKA (191)
DORSET (IND) +  KABA (103)
DOUBLE ARROWS (RC)
DOUBLE CIRCLE (RC) TRI-CIRCLE
DOUBLE SAFE (GB)  EURO LOCKS (71)  L & F (116)
DUBOIS (F)  LAS (110)
DUO (USA)  ILLINOIS (96)
DUPLOMATIC (I)
DYES (D)  DOM (62)
EAG (D)
EAGLE (USA) DNS HARLOCK LORI
EAO (D)  DOM (61)
EAST (RC)
EBA (I)  MERONI (124)
ECM (P)



68

PER / FOR

EFCO (AUS)

EFSA (F)

BABY-CLIP (27)

EGSA

TOK-WINKHAUS (170-171)

EIKO (RC)

CINA (48)

EKLA (HK)

GUARD (90)

ELCA (D)

STS
TESA
VIRO

ELDON (D)

EMKA (69)

ELEPHANT (RC)

TRI-CIRCLE (172)

ELFIN (I)

CEMA (41)

ELKO (CZ)

ELMO (USA)

BASCO (28)

ELP (RUS)

ELSA (I)

GIUSSANI (86)

ELSET (F)

CLAUSOR (51)

ELSI (I)

INDESIT (96)

ELVOX (I)

GIUSSANI (86)

ELZETT (H)

TIEFENTHAL
+ CES (41-42)

EMGE (F)

RONIS (147)

EMHART (USA)

CORBIN (55)

DOM (62-63)

RONIS (146-147)

PER:
FOR:

EFCO

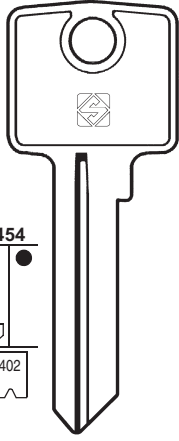

454
6
402

0-1-2-3-4-5-6-7-8-9



▲ EF7

- CA EF1R
- CK EF2R
- DA EF3R
- DB EF4R
- DK EF5R
- DM EF6R

ELCA

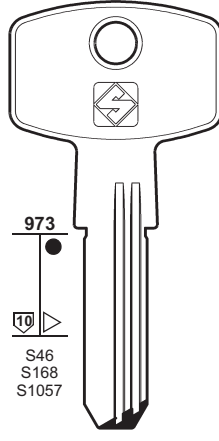

973
10
S46
S168
S1057



EC5



STS - TESA - VIRO

ELKO

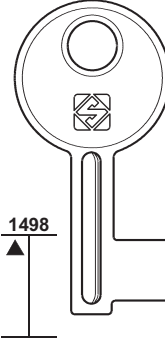

1498



ELK1

ELP

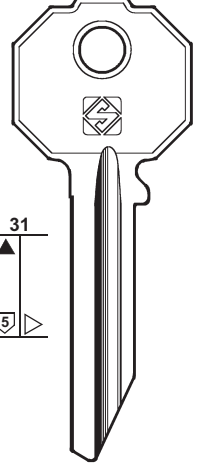

31
5



ELP1R

PER:
FOR:

ELZETT

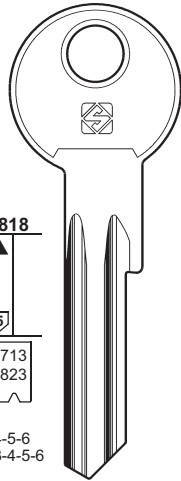

818
5
713
823
1-2-3-4-5-6
0-1-2-3-4-5-6



EL1X

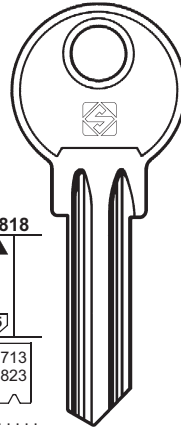

818
5
713
823
1-2-3-4-5-6
0-1-2-3-4-5-6



EL1



TUTIS
TIEFENTHAL

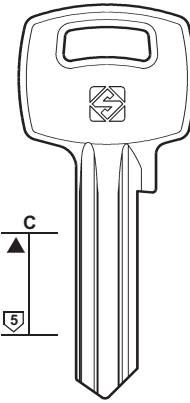

C
5



EL1C

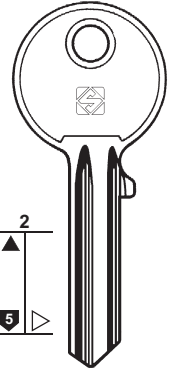

2
5



EL3

PER:
FOR:

ELZETT

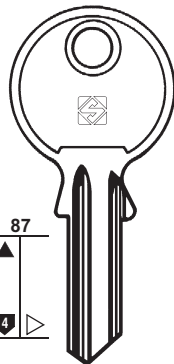

87
4



EL2

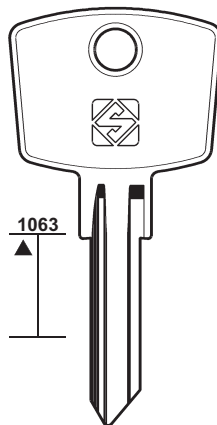

1063



EL4



EL6



EL5R



EL7R

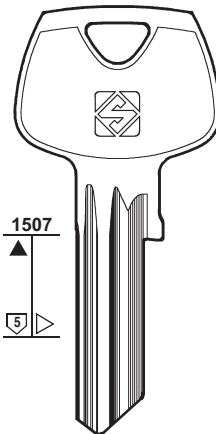

1507
5



EL10

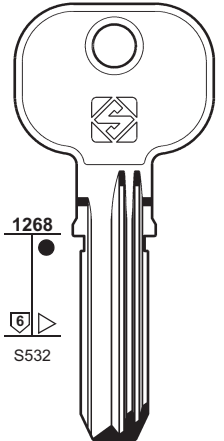









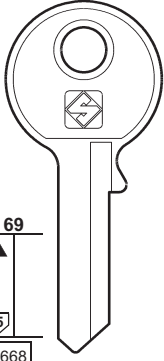
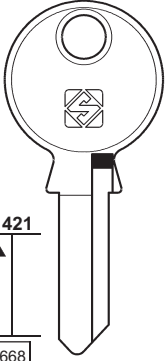
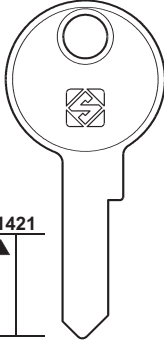
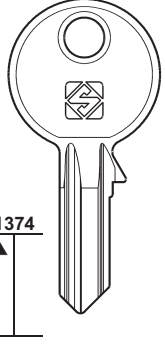
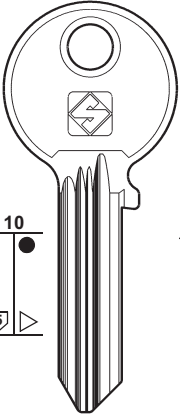



1268
6
S532
0-1-2-3-4







EL9

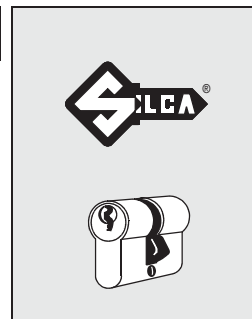



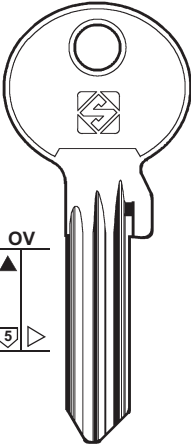
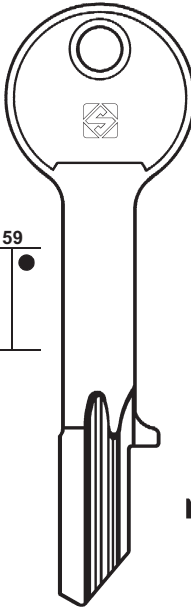
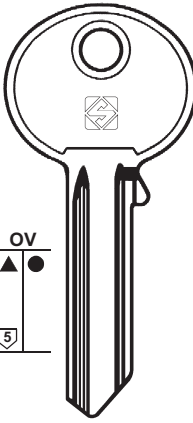
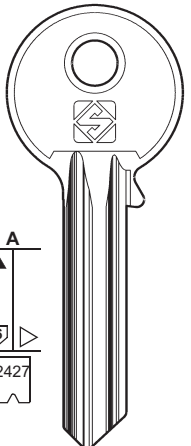



EMKA				EMR
				
69 ▲ 5 668	1421 ▲ 5 668	1421 ▲ 5	1374 ▲ 5	10 ● 5
..... 1-2-3-4	XX ... 091-320			
				
EMK1	EMK5	EMK6R	EMK2	EM4
				
			EMK3R	EM1
				
				EM1R
				
				EM2R
				
				EM3R
				
				EM3
ELDON - GHE KOVER - RONIS				DOM - GTV - JOWIL TIEFENTHAL

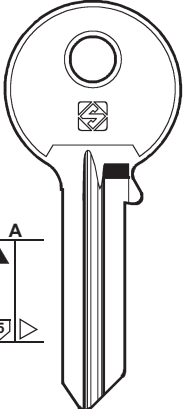
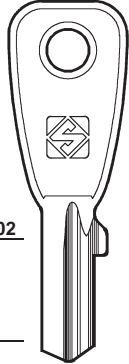
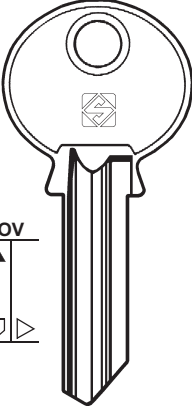
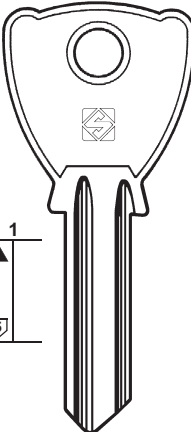





69

EMR	ENEL	ERA	
			
OV ▲ 5	59 ●	OV ▲ ● 5	A ▲ 6 2427
		 1-2-3-4-5-6-7-8-9
			
EM11	EN1R	ER1	ER2
GTV - JOWIL			

ERA		ERTEL	ESA
			
A ▲ 5	1402 ▲	OV ▲ 5	1 ▲ 5
			
ER3R	ER4R	ERT1	ES1R
			
			ES1
			NUMIDIA

PER / FOR

EMKA (F)
 ELDON
 GHE
 KOVER
 RONIS
 +  EURO LOCKS (70)
 +  FORT (81)
 +  RONIS (146)
 +  TITAN (167)
 +  WILKA (191)

EMR (D)
 DOM
 GTV
 JOWIL
 TIEFENTHAL

ENAX (F)
 TOK-WINKHAUS (171)

ENEL (I)

EPO (J)
 SCHLAGE (151)

EQUIBATIR (F)
 RONIS (146)



ERA (GB)

ERICSSON (S)
 TEKA (165)

ERMEX (S)
 TEKA (165)

ERTEL (D)

ESA (E)
 NUMIDIA

ESAFE (E)
 EZCURRA (73)
 TESA (165)

ESCO (D)
 CISA (48)
 CORBIN (53)

ESLA (GB)
 CISA (49)

ESS (D)
 BAB (25)

ESSENDIA (S)
 CISA (48)

ESZ (D)
 JOWIL (100)



70

PER / FOR

ETAS (GB)
YANEDIS

ETF (F)
+ BABY CLIP (27)

ETNA (I)
+ CAS-CISMA (40)

EUREKA (I)
ITALBLOCK

EURO LOCKS (B)
FASMA
L & F
SCHULTZ
+ BASTA (28)
+ CHICAGO (46)
+ L & F (116-117)

PER: FOR:	ETAS	ETF	ETNA
	 ETA1 YANEDIS	 ETF1	 ET1 ET1R ET2R

PER: FOR:	EUREKA				EURO LOCKS
	 EK1	 EK1R	 EK2R	 EK4	 EK3
				 EK3R	 EU17
	ITALBLOCK				

PER: FOR:	EURO LOCKS			
	 EU3	 EU12	 EU19	 EU18R
	 EU1R 1201-1400 45001-48000 45001-49001 43001-45000 48001-49000 2151-2949 5272-6291	 EU5R 25001-27000 FASMA	 LF4 60 ... 1-400 90 ... 1-200 92 ... 1-400 ... 1-400 GHM ... 1-155 M ... 1-400 92 ... 401-600 99 ... 1-400 RV ... 1-400 RVM ... 1-400 SP ... 1-400 GS ... 1-400 ... ES1 ... EV1	 LF4R 99 ... 401-600 92 ... 501-700
	 EU11R	 EU1R	 LF6	 LF6R 90 ... 1-200 ... 1-400 91 ... 201-275 GH ... 1-400 SS ... 1-400 91 ... 276-350
	SCHULTZ			LF18R
		L & F		L & F

PER:
FOR:

EURO LOCKS

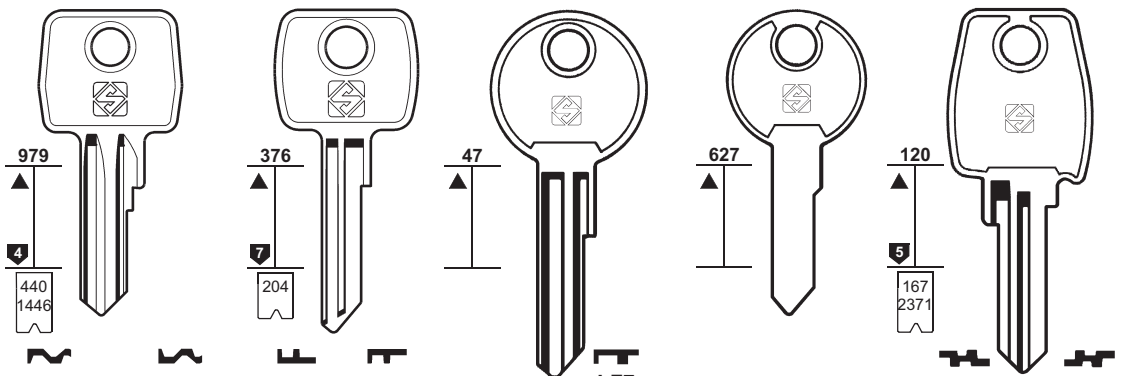

<p>EU4 E 01234 E 1111-4444 405-4324 E 405-4324</p> <p>EU2</p> <p>EU7</p>	<p>EU4R A 01234 A 1111-4444 458-5124</p> <p>EU2R</p>	<p>LF11 76 ... 1-400 70001-71000 M ... 70001-71000</p> <p>LF11R</p>	<p>LF7</p> <p>LF8 LF8R</p> <p>LF29R</p>	<p>LF16 LF16R</p> <p>LF2 LF26</p> <p>G ... 1001-5000 31001-32000 77001-77500 32001-33000 95000-99000 36001-38000 38001-38999 77001-77500 95000-99000</p>
---	--	---	---	--

L & F

L & F

DOUBLE SAFE



71

PER / FOR

EURO LOCKS (B)

BASI
DETHLEF
DOUBLE SAFE
HOBBY
KNAUS
L & F
TRABER
VIOMETAL

+ BASTA (28)
+ CHICAGO (45)
+ L & F (116-117)

EURONORM (D)

CORBIN (53)
 CORNI (55)

EUROP (F)

SUREX (163)

EUROSPEC (GB)

EVERGOOD (RC)

JNF
MERONI
SISO

PER:
FOR:

EURO LOCKS

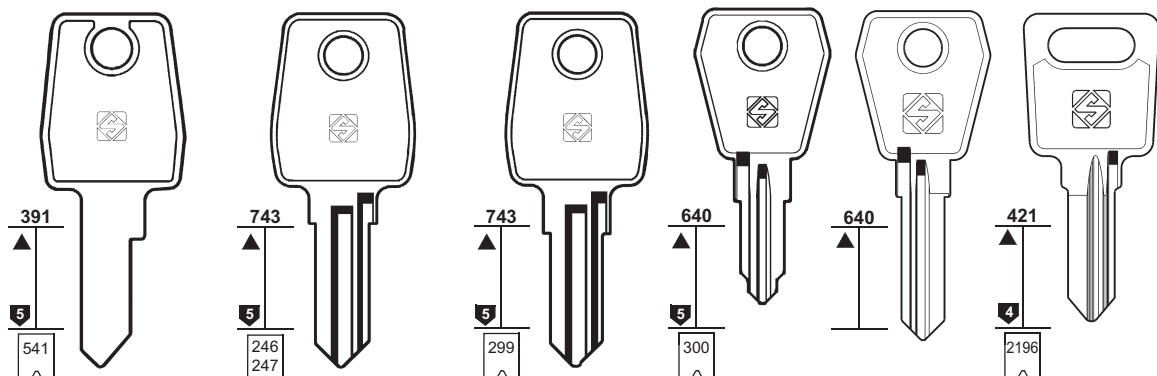

<p>LF13</p>	<p>LF22 93 ... 201-400 93901-94000</p>	<p>LF22R</p>	<p>LF20 LF20R</p> <p>93901-94000</p>	<p>LF30R 801-900 901-1000</p>	<p>EU16R</p>	<p>EU14 IF ... 1-2-3-4</p>
<p>LF17 LF15R</p> <p>L & F</p>	<p>EU13R 2001-4000 B ... 001-1000 C ... 001-1000</p>	<p>LF23R 93 ... 401-900 9001-95000 EL ... 9001-9500 EL ... 1-500 1001-1100</p>	<p>EU9</p> <p>BASI - L & F VIOMETAL</p>	<p>L & F</p>		

PER:
FOR:

EURO LOCKS

EUROSPEC

EVERGOOD

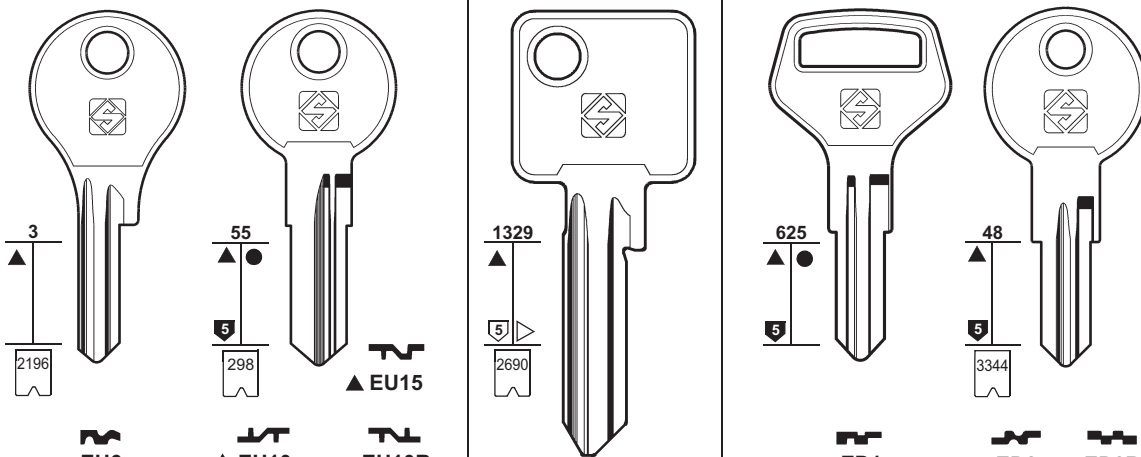

EU6

EU10 **EU10R**
..... 2001-2200



DETHLEF - HOBBY
KNAUS - TRABER



EUS1
..... 123456



JNF - SISO



72

PER / FOR

EVO (GB)
MILA

EVVA (A)
TRYBA

EXCEL (F)
+ SIDLEEN (154)

EXPRES (PL)
LOB (114)

PER: EVO
FOR:

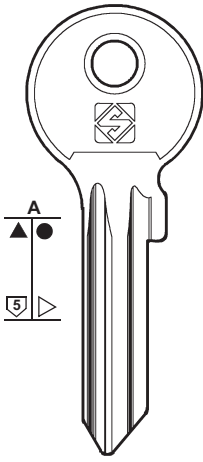

EVO1
MILA

EVVA

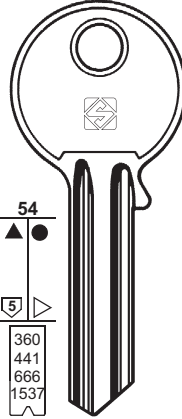

360
441
666
1537
... A 1000-9999
... A . 1000-9999
... A . 1000-9999
... A . 1000-9999
... 1234567890
... 1234567890
XA ... 40000-59999
A ... 5600-9999
... 60001-97000

... C 1000-9999
... C . 1000-9999
... C . 1000-9999
... C . 1000-9999
... () 1234567890
C ... 5600-9999
C ... 60001-97000

EV2
E
 EV3
C
 EV3R
2C
 EV4
F
 EV4R
2F
 EV5
Z
 EV9
BB
 EV10
A
... Z 1000-9999
... Z . 1000-9999
... Z . 1000-9999
... Z . 1000-9999
... Z . 1000-9999
Z ... 5600-9999
... F 1000-9999
... F . 1000-9999
... F . 1000-9999
F ... 5600-9999

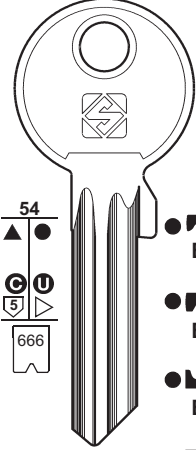

5S ... 40000-59999
S ... 40000-59999
S ... 60001-80000
S ... 98000-99965

EV3X
C
 EV3RX
2C
 EV4X
F
 EV4RX
2F
 EV5X
Z
 EV9X
BB
 EV2X
E
 EV10X1
A
 EV69X
S
 EV64RX

PER: EVVA
FOR:

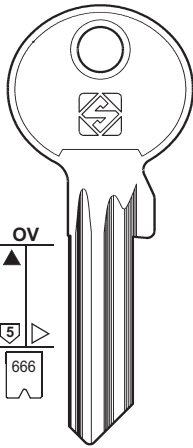

EV10X
A ... 60001-97000
TRYBA

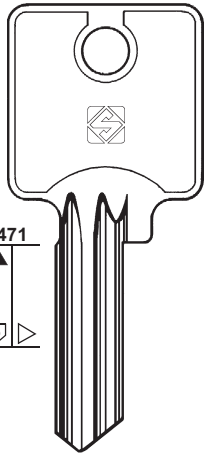

EV11
C

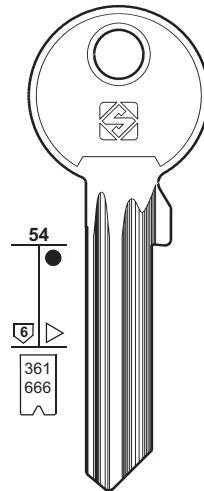

EV12
A
6S ...
40000-59999

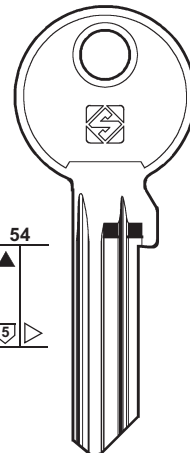

EV81X

EV103X-2

EV103X-3
 EV103X-8

EV103X-4
 EV103X-9

EV103X-5
 EV103X-10

EV103X-6
 EV103X-11

EV103X-7
 EV103X-12

PER: EVVA
FOR:

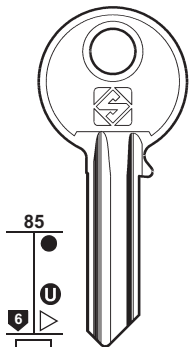

EV8
K1
... 2001-2479
... 1234567890

EV8R
K0
... 1001-1479
... 1234567890

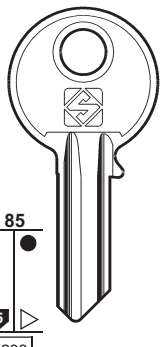

EV7
K1
... 4001-4250

EV7R
K0
... 3001-3250
M ... 3001-3250

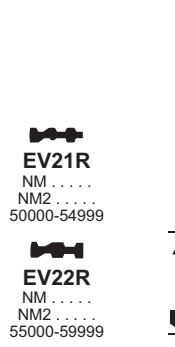

EV21R
NM ...
NM2 ...
50000-54999

EV22R
NM ...
NM2 ...
55000-59999

EV23R
NM ...
NM2 ...
60000-64999

EV24R
NM ...
NM2 ...
65000-59999

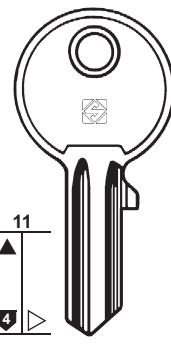

EV6
K1

EV6R
K0



EXCEL

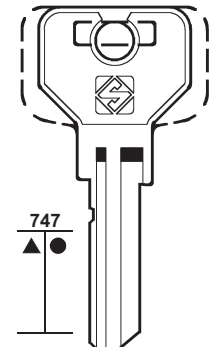

EX1



PER:
FOR:

EZCURRA

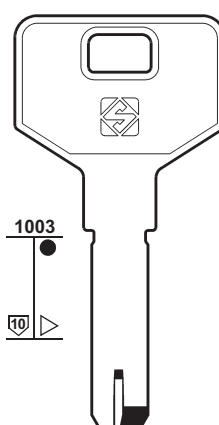
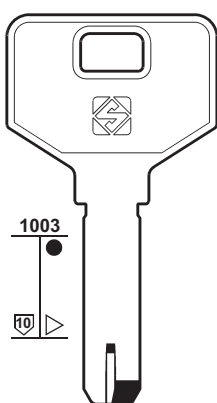
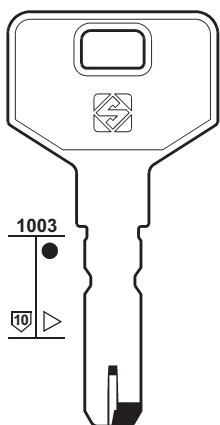
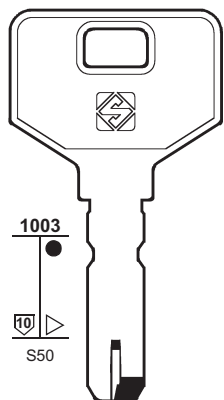

EZ3
DS10

EZ3X
DS10



EZ6
DS15

EZ6X
DS15



73

PER / FOR

EZCURRA (E)
ESAFE
JMR
NAZABAL
+  SEA (152)

E-Z-SET (USA)
 KWIKSET (108)

PER:
FOR:

EZCURRA

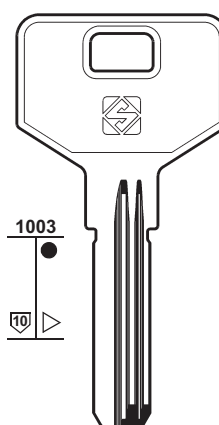
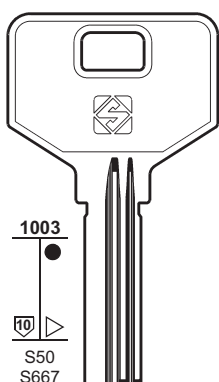
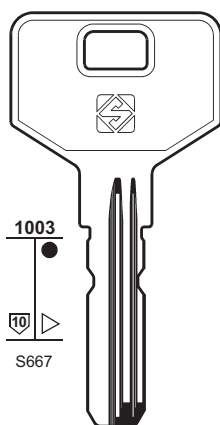
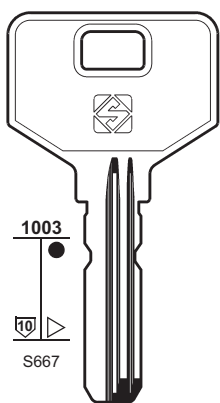

EZ4
DS10-E

EZ4X
DS10



EZ5
DS15-E

EZ5X
DS15

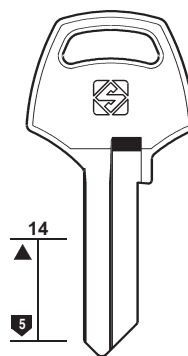
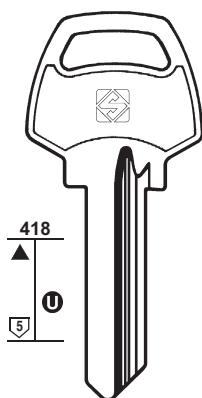
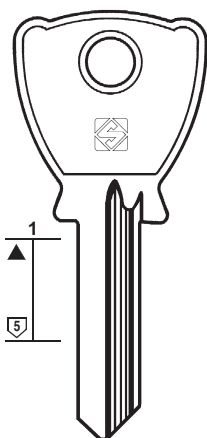

PER:
FOR:

EZCURRA



EZ1

EZ2R

EZ7

NAZABAL

ESAFE - JMR



74

PER / FOR

FAB (CZ)
GUARD
LOB
YETI

PER:
FOR:

FAB

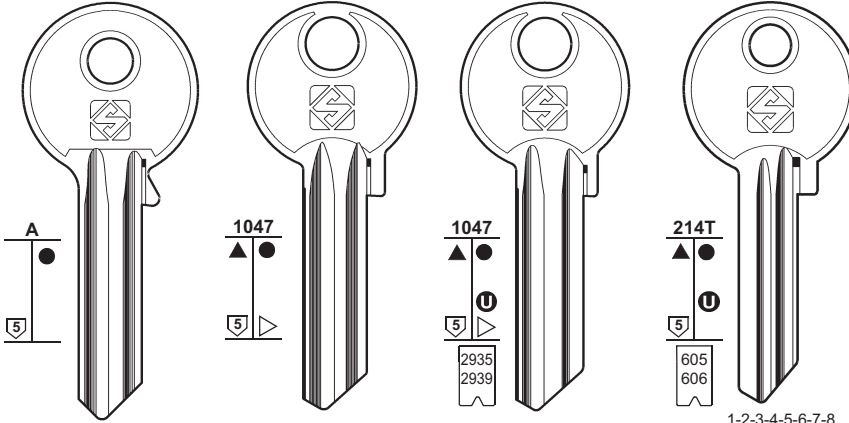

FB26
40



FB26R
40 1/2



FB23
41



FB23R
41 1/2



FB24
PP

..... 0123456789ABC
..... 0123456789



FB9



FB10R
13

11P
FB1



FB33

10P
FB2



FB33R

FB3R



FB42R

FB4R



FB81

FB5R



FB81R

FB6R

FB7R

FB8R

GUARD

GUARD

LOB - YETI

PER:
FOR:

FAB

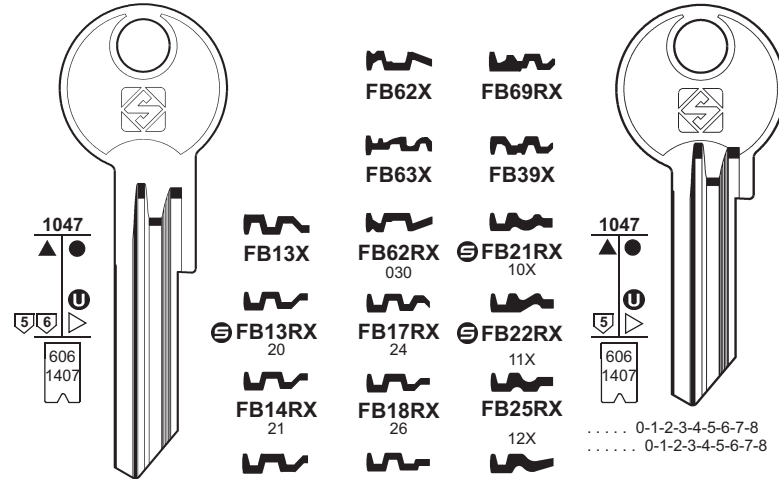

FB62X

FB69RX

FB63X

FB39X

FB13X

FB62RX

FB21RX

FB21RX

FB57R

FB21R

FB13RX

FB17RX

FB22RX

FB22RX

FB13R

FB17R

FB22R

FB14RX

FB18RX

FB25RX

FB25RX

FB14R

FB18R

FB25R

FB15RX

FB19RX

FB28RX

FB28RX

FB15R

FB19R

FB27R

FB16RX

FB20RX

FB20X

FB20X

FB16R

FB20R

FB28R

..... 0-1-2-3-4-5-6-7-8
..... 0-1-2-3-4-5-6-7-8

..... 0-1-2-3-4-5-6-7-8
..... 0-1-2-3-4-5-6-7-8

PER:
FOR:

FAB

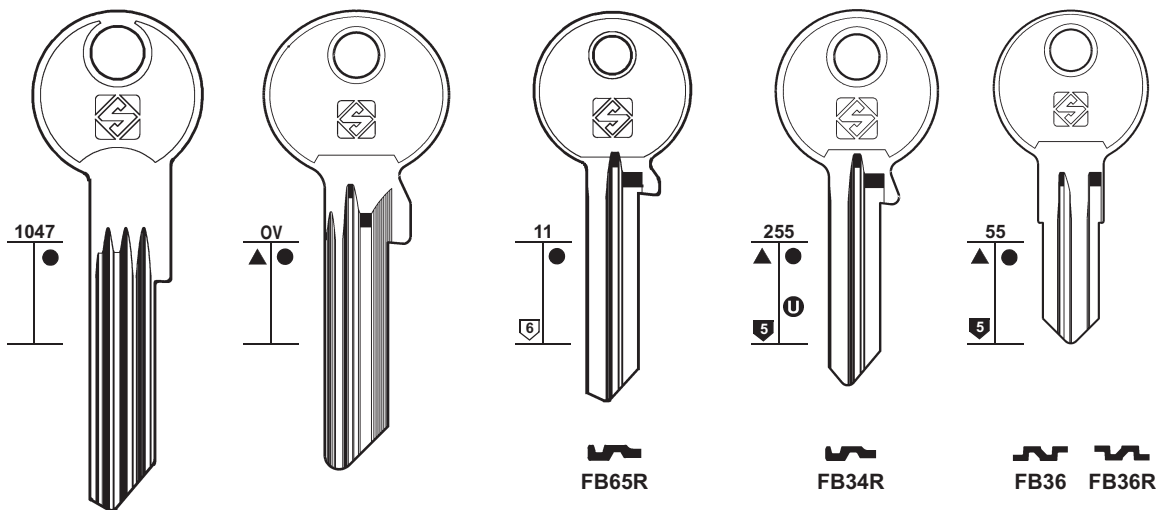

FB64RX
027

FB64X

FB35R
K

FB65R

FB34R

FB75R

FB36 FB36R



PER:
FOR:

FAC

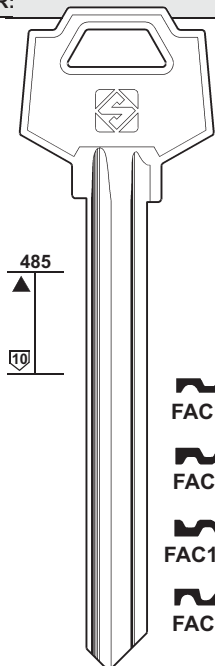

FAC1R
FAC10
FAC10R
FAC11●

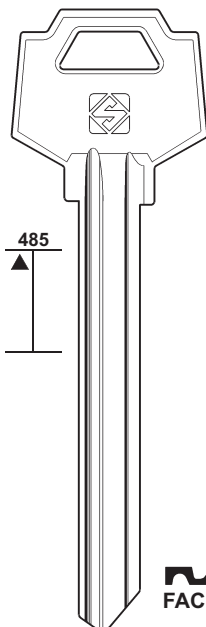

FAC14

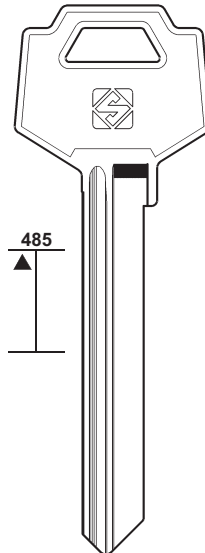

FAC12

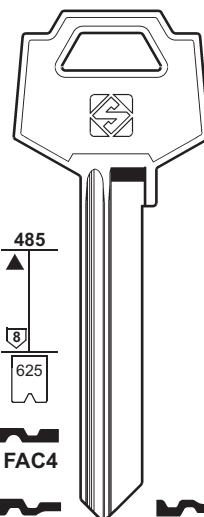

FAC4
FAC6
FAC9
FAC6R
FAC13

0123456789



75

PER / FOR

FAC (E)
ARREGUI
INDAUX

PER:
FOR:

FAC

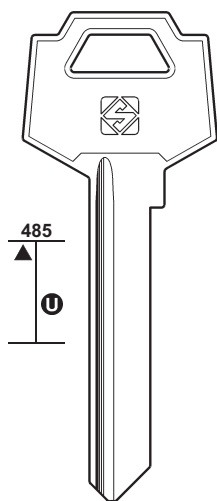

FAC7
FAC8

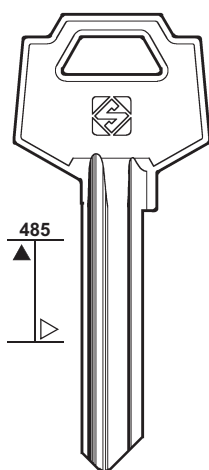

FAC30

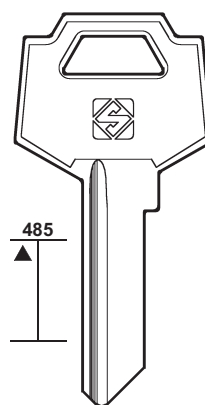

FAC29

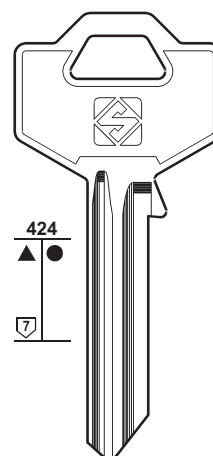

FAC5R
FAC5

PER:
FOR:

FAC

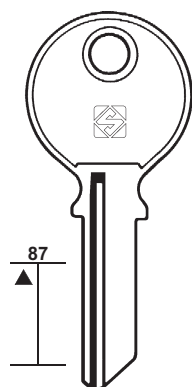

FAC3R
FAC3

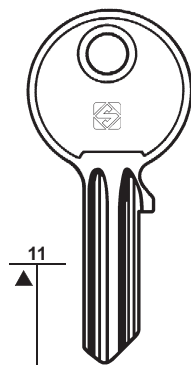

FAC2R
FAC2

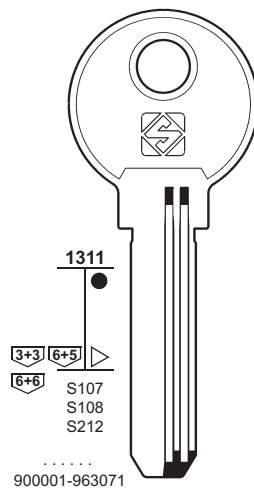

900001-963071

FAC15

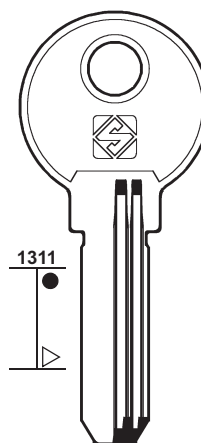

FAC31

ARREGUI - INDAUX

Copyright by Silca S.p.A. 2013 - All rights reserved





76

PER / FOR

FAI (I)
VIRO
+ VIRO (186)

FALCON (USA)
WEISER
+ BEST (29)

FAMA (I)

FAMA (BR)

FANA (PL)
+ BRUMME (36)

FARCE (F)
+ MELSMETAL (122)

FAS (S)

PER:
FOR:

FAI

FAI1R FAI2 FAI3

VIRO VIRO

FALCON

FN1 FN2 FN4

WEISER

PER:
FOR:

FAMA (I)

FAM1 FAM1R ▲ FAM2R

FAMA (BR)

FAM6 FAM3

..... 1-2-3-4-5-6-7-8-9-0-A

PER:
FOR:

FAMA (BR)

FAM9 FAM5 FAM8

..... 1234567890

FANA

FAN1

..... 123456789ABC

FAS

FS1 FS1R

PER:
FOR:

FASEM

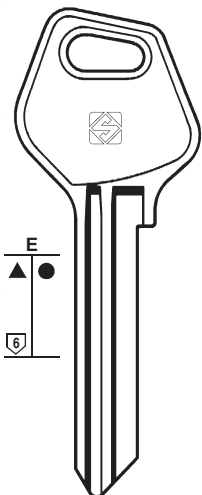

FM7

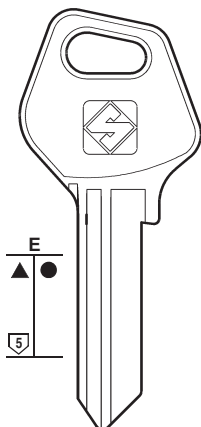

FM6

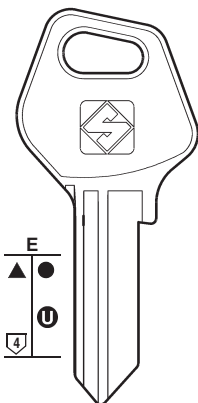

FM1

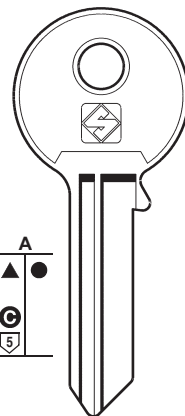

FM090

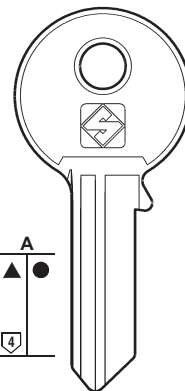

FM2

ILS
IULIA MAS FED

FPB



77

PER / FOR

FASEM (I)
BERETTA
BV
FPB
ILS
IULIA MAS FED
JUWEL
+ BIELLE (30)

PER:
FOR:

FASEM

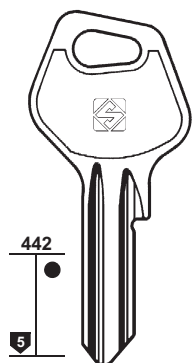

FM5

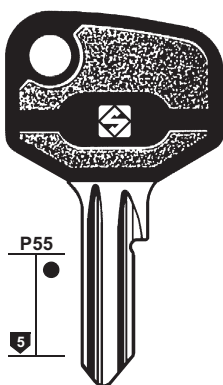

FM5P

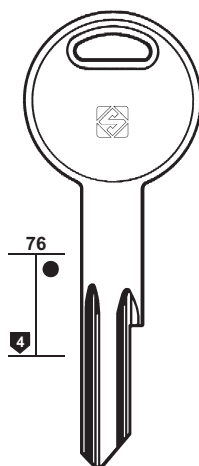

FM8

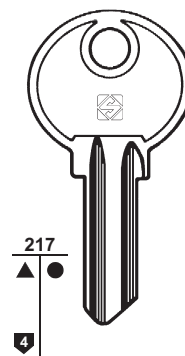

FM4

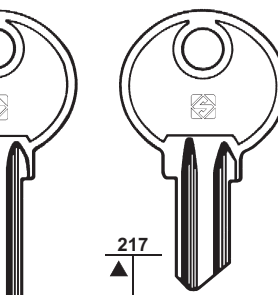

FM4R

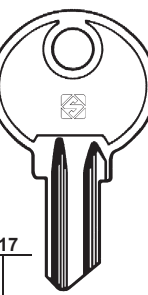

FM3



FM3R

BERETTA - BV

JUWEL

JUWEL

FASMA (I)
 EURO LOCKS (71)

FATTORINI (I)
 PREFER (142)

FAVOUR (DZ)

FAYN (TR)

FB (E)
 AGA (11)

FBC (I)
 GIUSSANI (86)

PER:
FOR:

FAVOUR

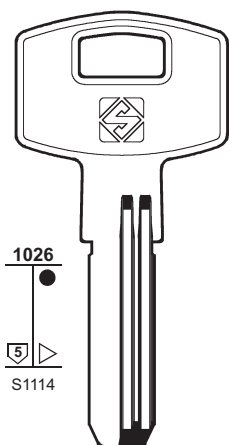

FVR1

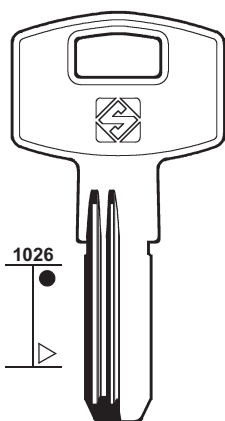

FVR2R

FVR4R

FVR3

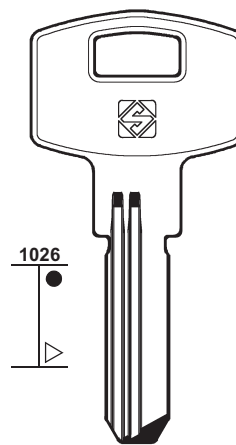

FY1R





78

PER / FOR

FCV (D)

- KFV
- VBH
- + KfV (105)

FEB (I)

- + ALPHA (15)
- + CORBIN (53)
- + JVAL (102)
- + MORI E. (129)
- + P.C. (CORTELLEZZI) (139-140)
- + VIRO (186)

FEDERAL (F)

- + FTH (82-83)
- + JUNKUNC (101)

FEFI (D)

- + CES (42)

FEL (D)

- + SIS (156)

FERCO (F)

- + YALE (195)

FERMABLOCK (I)

- + OLIVA (134)

FERONERIA (RO)

F.F. (I)

- + GUARDIAN

PER:
FOR:

FCV

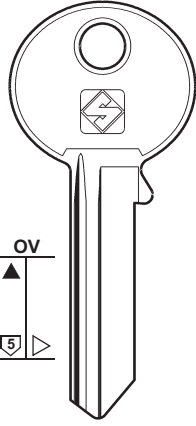

FV1

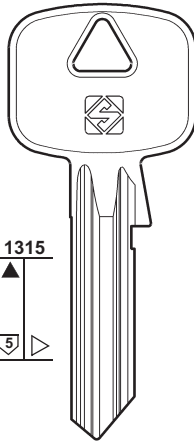

FV2

KFV

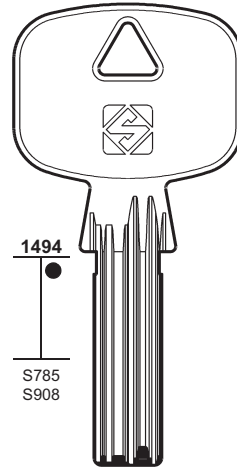

FV4



KFV - VBH

FEB

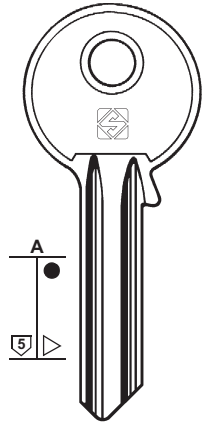

FEB2 FEB2R

PER:
FOR:

FEB

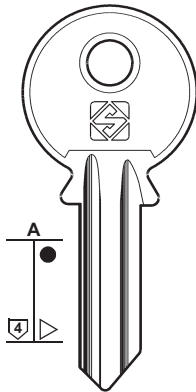

FEB1

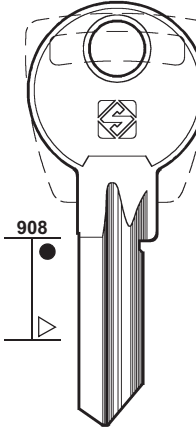

FEB6R

FEDERAL

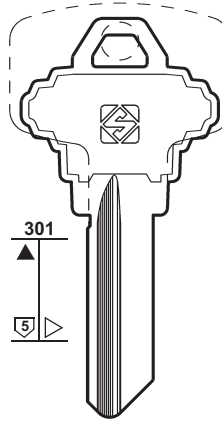

FDR1

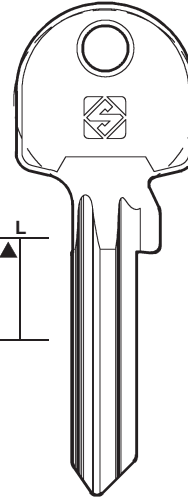

FDR2

FERONERIA

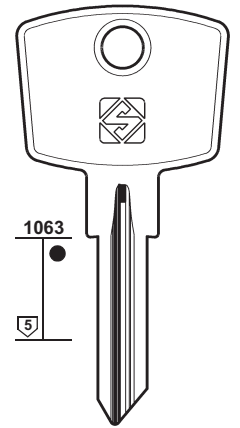

FRN1R

PER:
FOR:

F.F.

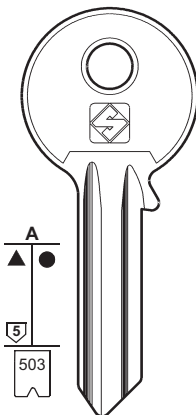

FF1

.....0-1-2-3-4-5-6-7

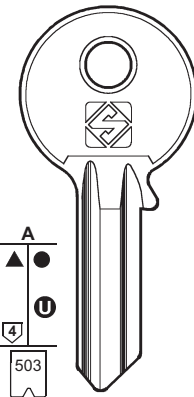

FF2

.....0-1-2-3-4-5-6-7

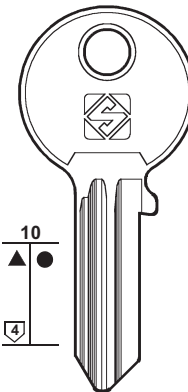

FF15

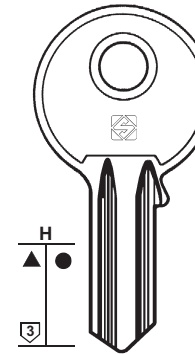

FF3



FF3R

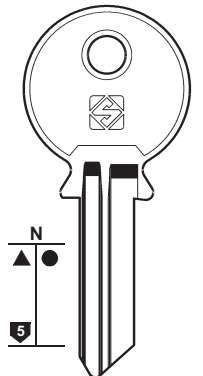

FF14



FF8



FF8R



FF9



FF9R



FF10



FF10R



FF17



FF7



FF7R

GUARDIAN

GUARDIAN

PER:
FOR:

F.F.

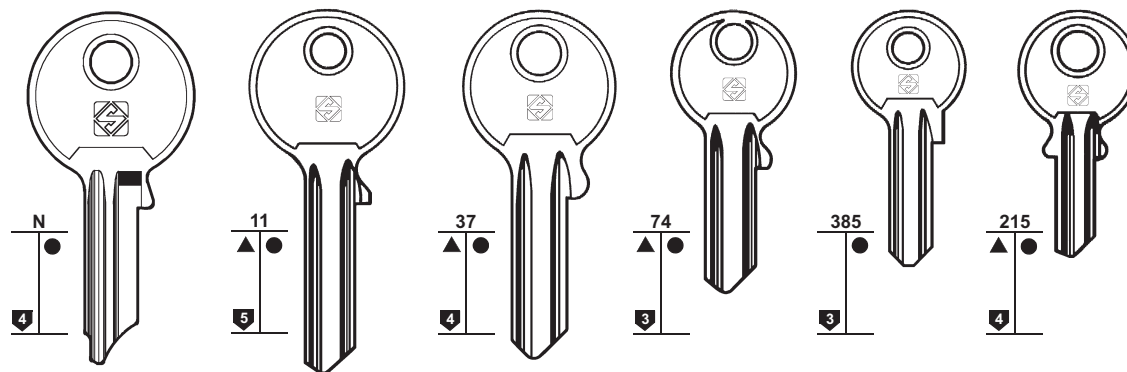

FF18

FF4

● FF4R

FF12

FF12R ▲

● FF5

FF13

● FF6

FF11

FF11R

FF5R

FF13R

FF6R



79

PER / FOR

F.F. (I)

FIAM (I)

+ KESO (105)

FIK (KSA)

+ ZANI (200)

PER:
FOR:

F.F.

FIAM

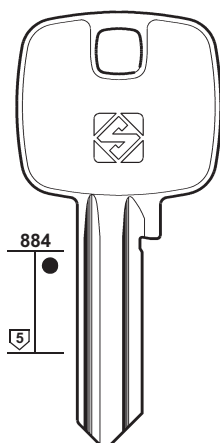

FF16

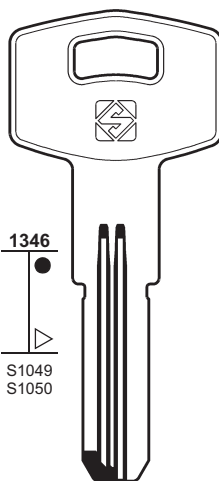

FI3R

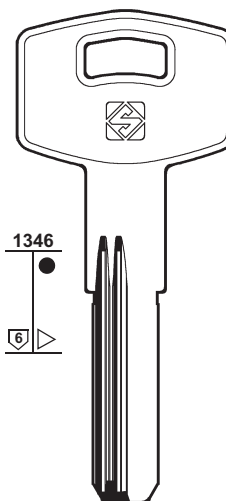

FI4R



PER:
FOR:

FIAM

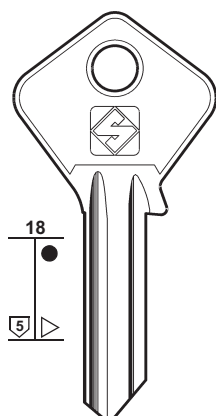

FI234

FI235

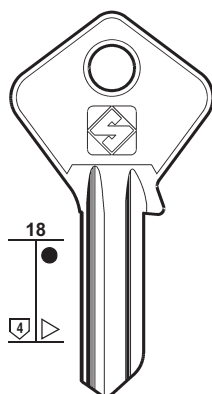

FI232

FI233

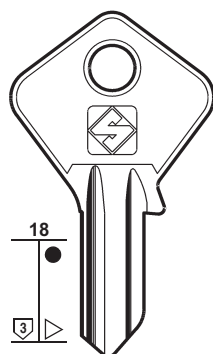

FI1

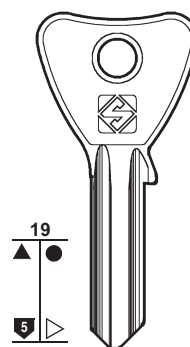

● FI064

FI065



80

PER / FOR

FICHET (F)
SURFINOR
TECNOR
+ TOK-WINKHAUS (171)

FIMANEVSKI (RUS)
DNEPROPETROVSK
(59)

FIRMADOOR (AUS)

FIRST (CH)

FIS (I)

PER:
FOR:

FICHET

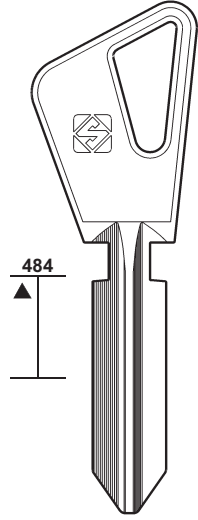

484



FT4



SURFINOR

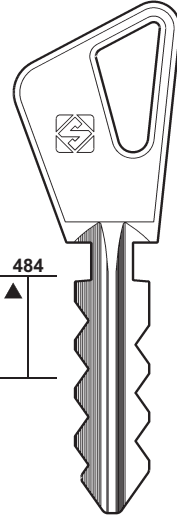

484



FT4C



SURFINOR

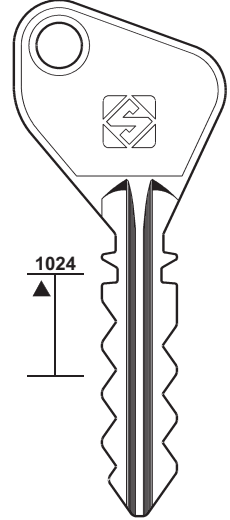

1024



FT5C



PER:
FOR:

FICHET

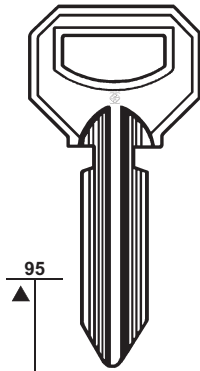

95



FT3



TECNOR

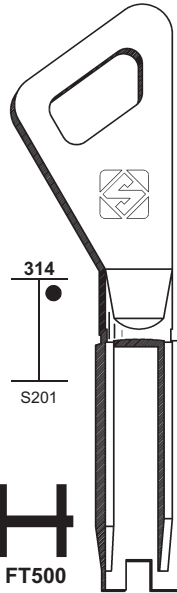

314

S201



FT500

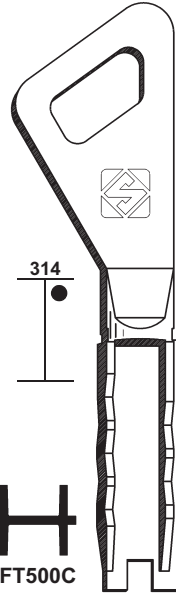

314

S202



FT500C

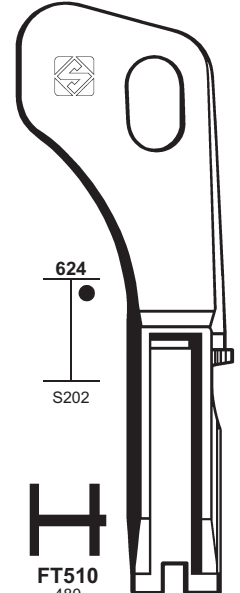

624

S202



FT510
480

PER:
FOR: FIRMADOOR

FIRST

FIS

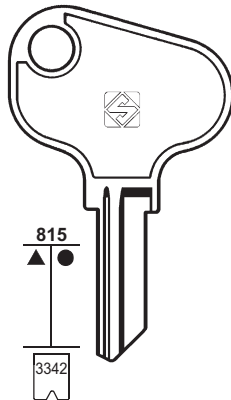

815

3342



FID1
B... 1-100

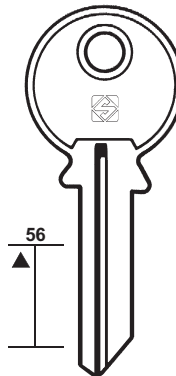

56



FIR1

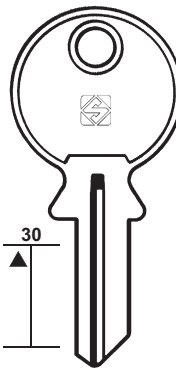

30



FIR3

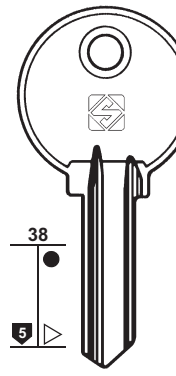

38

5



F1

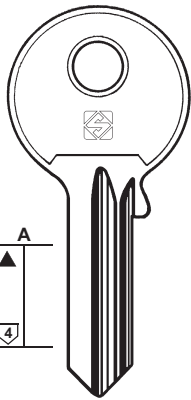

A

4



F2R

PER: FOR:	FIST	FLIK	FLIM	FLORA
				FLOHR - NB NORTHWEST - SUKI



81

PER: FOR:	FONDAR	FORT				
		<p>H 6001-6250 RM 7001-7200</p> <p>... 1-500 ... 9001-9500</p> <p>DAD - DECAEUX - EMKA SECURITAL - UTZ</p>				

PER / FOR
FIST (I)
FLAMBO (D) 👁️ DOM (61)
FLIETHER (D) 👁️ KFV (105)
FLIK (D) + 👁️ GEGE (84)
FLIM (RUS)
FLOHR (D) 👁️ FLORA (81)
FLORA (D) FLOHR NB NORTHWEST SUKI
FO (F) 👁️ CITY (51) 👁️ MONOBLOC (128) 👁️ ZENITH (201)
FONDAR (I) OT
FONTAINE (F) 👁️ CORNI (55) 👁️ RONIS (146) 👁️ VACHETTE (181)
FORINDEX (F) 👁️ RONIS (146-147)
FORT (USA) ARFE DAD DECAEUX EMKA HUDSON SECURITAL UTZ + 👁️ ABUS (9) + 👁️ ARROW (18) + 👁️ CHICAGO (45-46) + 👁️ LAS (110)
FORTIS (E) LBLM
FORTSCHRITT (D) 👁️ DOM (62) 👁️ ZEISS-IKON (201)
FOSAM (I) 👁️ PREFER (143)
FOUR-CIRCLE (RC) 👁️ YETI (198-199)
FPB (I) 👁️ FASEM (77) 👁️ P.C CORTELLEZZI (139)
FRAL (P) 👁️ P.C. CORTELLEZZI (139)
FRANZEN (USA)
FRANZMAR (BR)
FRECOV (D) 👁️ CES (41-42)
FTH (F)

PER: FOR:	FORTIS	FRANZEN	FRANZMAR		FTH



82

PER / FOR

FTH (F)

- CF
- CIB
- CIBC
- CITY
- DIAMA
- FEDERAL
- GISS
- GPR
- HUNIT
- IFAM
- JL
- NICO
- PICARDIE
- PROBAT
- SAMA
- SUF
- + 👁️ ABUS (8)
- + 👁️ BRUMME (36)
- + 👁️ CAS-CISMA (40)
- + 👁️ GLOBE (88)
- + 👁️ TITAN (168)

PER:
FOR:

FTH

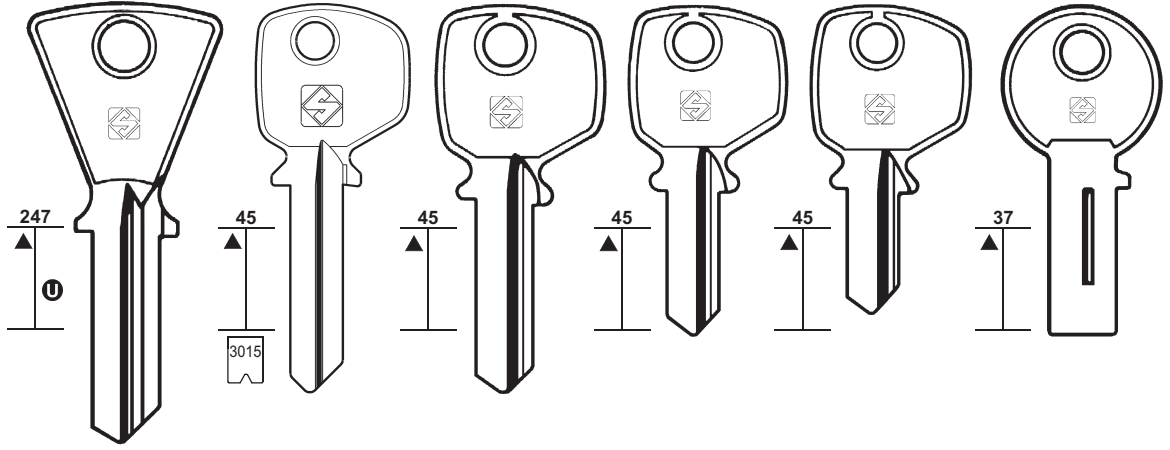

PER:
FOR:

FTH

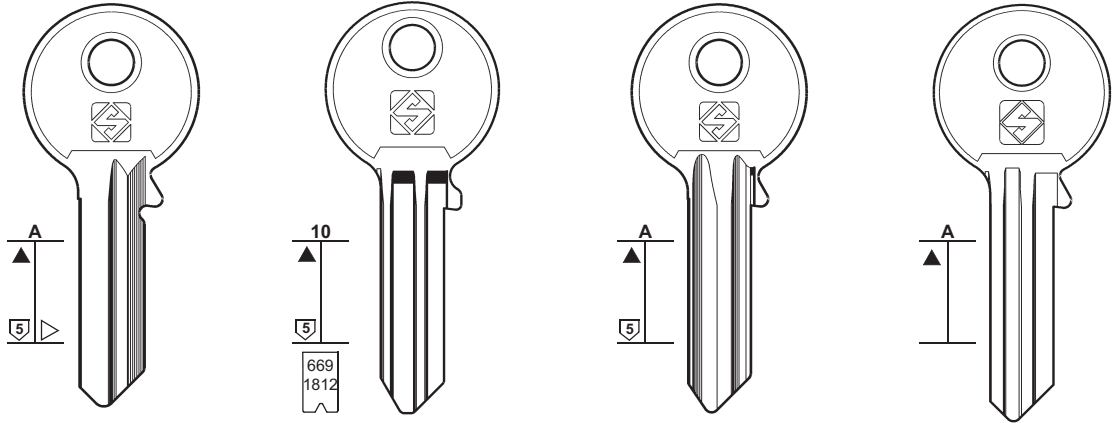

PER:
FOR:

FTH

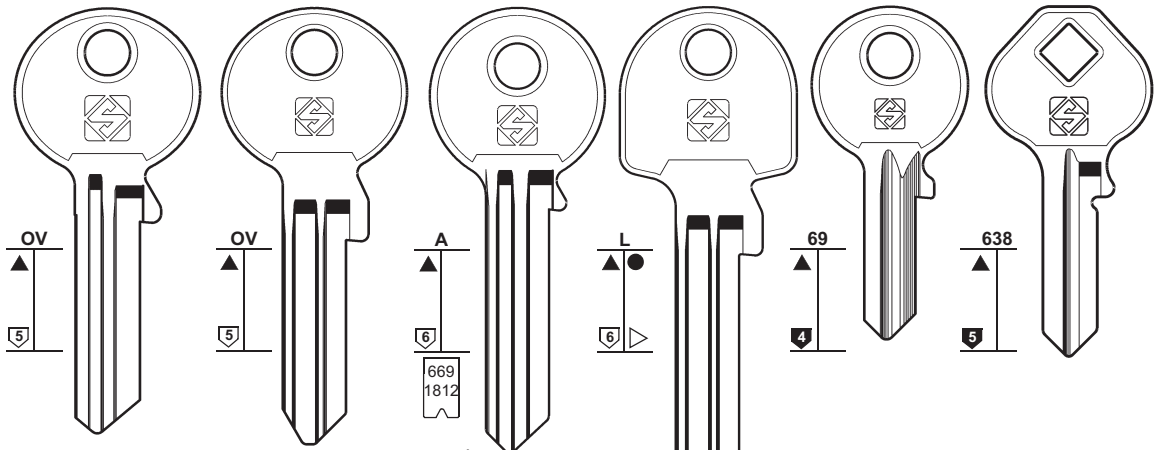

mm 50
CIBC - CITY - SUF

FEDERAL

PER:
FOR:

FTH

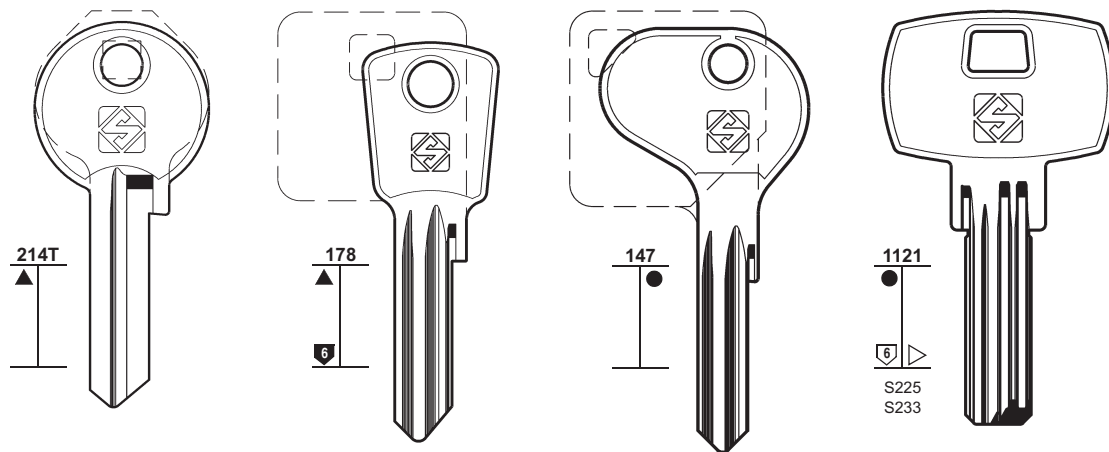

FH23R

FH21R FH22R

FH24R

FH12



83

PER / FOR

FTH (F)
 CODEM
 FEDERAL
 GOTTA
 IFAM
 ITO
 KARO
 SP
 TOVER
 YALTRES
 + ABUS (8)
 + BRUMME (36)
 + CAS-CISMA (40)
 + GLOBE (87)
 + TITAN (167)

FUHR (D)
 CES (42)
 JOWIL (100)

FULLEX (F)
 GEGE (85)

PER:
FOR:

FTH

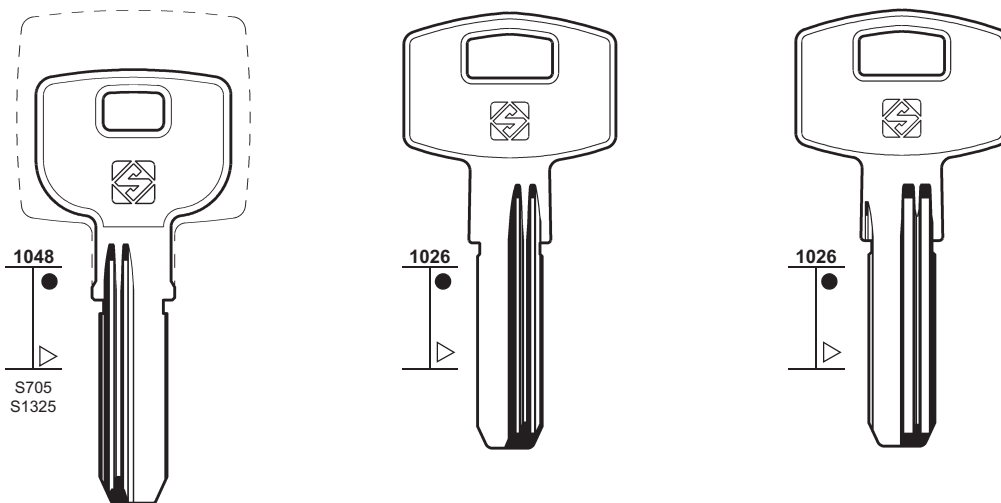

FH17R
..... 1-2-3-4-5
IFAM
KARO

FH37R

FH32

FH33

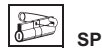

PER:
FOR:

FTH

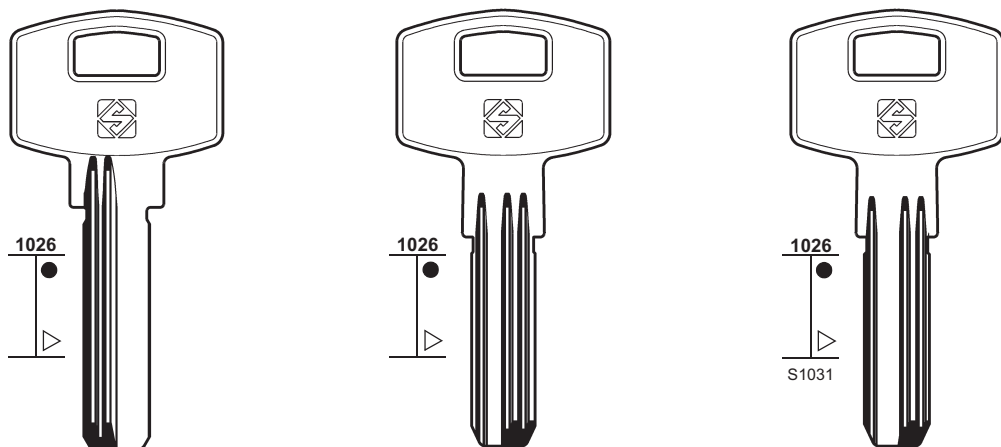

FH34R

FH35

FH36

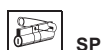

PER:
FOR:

GEGE

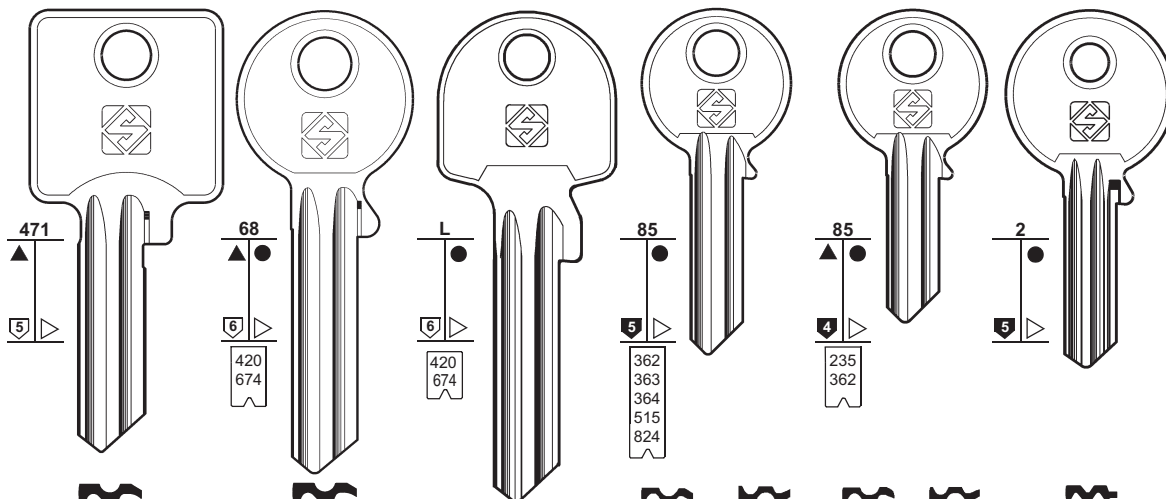

GE32

GE106

GE106XL

GE3 ▲GE3R

GE2 ●GE2R

GE118

1.....
500001-735807

1.....
500001-735807

..... U 1-14518
..... 10000-16539
..... 1234567
..... 1234567890

E... 00-576
... T 1-1750
X... 1001-1875

PEROHAUS

LABOFA



85

PER / FOR

GEGE (A)
LABOFA
PEROHAUS
+ ABUS (7)

GEM (USA)
CHICAGO (46)

GENTILI (I)
CILA (47)

GERA (D)
+ BUVA (39)
+ SATURN (151)
+ STARLET (161)

GETE (D)
CISA (48)

PER:
FOR:

GEGE

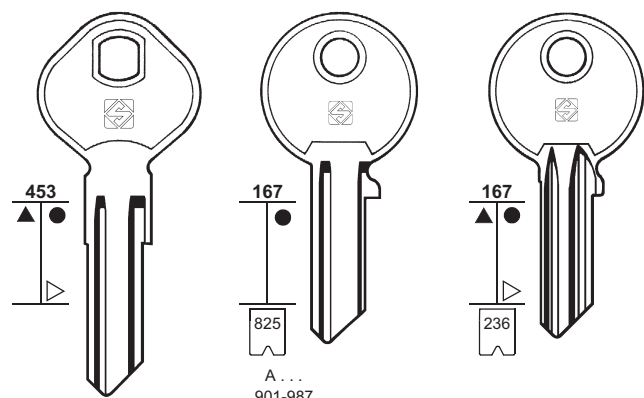

▲GE17 GE16R

●GE15 ▲GE15R

GE14



GE20
M 7
Z...
1491-1735

GE22
M 10
Z...
1981-2222

GE24
M 29
Z...
13743-14894

GE25
M 30
Z...
14895-16046

GE19R
M 6
Z...
1246-1490

GE21R
M 9
Z...
1736-1980

GE24R
M 20
Z...
3375-4526

GE25R
M 21
Z...
4527-5678

GE26
M 31
Z...
16047-17198

GE27
M 32
Z...
17199-18350

GE28
M 33
Z...
18351-19502

GE29
M 34
Z...
19503-20654

GE30
M 35
Z...
20655-21806

GE31
M 36
Z...
21807-22958

GE26R
M 22
Z...
5679-6830

GE27R
M 23
Z...
6831-7982

GE28R
M 24
Z...
7983-9134

GE29R
M 25
Z...
9135-10286

GE30R
M 26
Z...
10287-11438

GE31R
M 27
Z...
11439-12590

PER:
FOR:

GERA

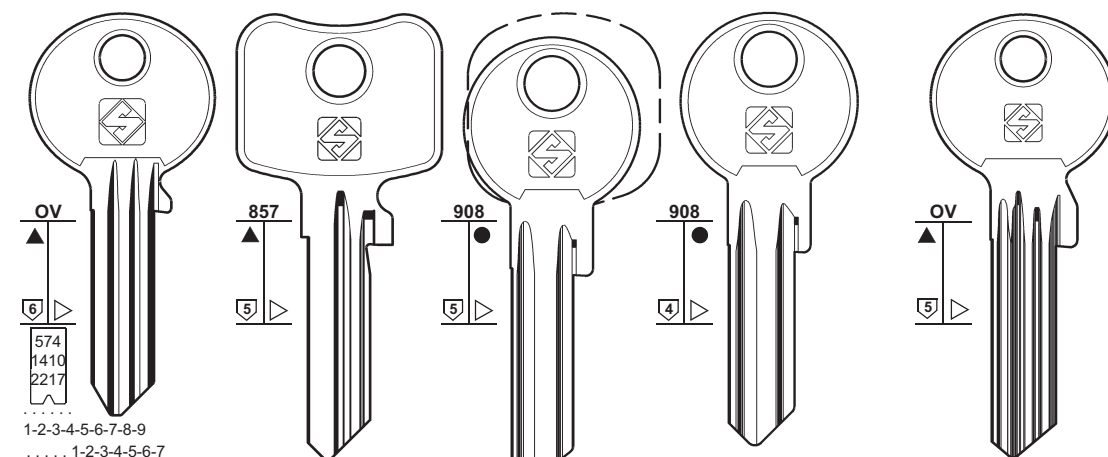

GR1R

GR2R

GR3
PZ6900

GR4
PZ5900

GR9-5

GR9R-3

GR9-7

GR9-8

GR9-9

GR9R-1

1-2-3-4-5-6-7-8-9
..... 1-2-3-4-5-6-7
N..... 1-28800



86

PER / FOR

GEVY (GR)
 MOTTURA
 + CISA (48)
 + DELCA (58)
 + P.C.
 CORTELEZZI (140)

GEWIRU (D)
 DOM (61)

GEWISS (I)

GHE (D)
 EMKA (69)
 LA PORTE (110)

GHIDINI (I)
 ZANETTI A. (200)

GIESCHE (GB)
 CES (42)
 KFV (105)

GIMM (F)
 RONIS (147)

GIOBERT (I)
 OLIVETTI

GIBBONS (GB)
 WILLENHALL

GIP (F)

GISS (F)
 FTH (82)

GIUSSANI (I)
 BRETER
 CAB
 ELSA
 ELVOX
 FBC
 LUME
 METALCASTELLI
 MLP
 OAL
 PLG
 SIMECA
 + BRETER (34)
 + TITAN (167)

PER: FOR:	GEVY	GEWISS	GIOBERT		
	1434 S1103 S1125 S1127 S1157	385 	73 	73 	21
	 GVY1R 600001-613040 900001-902780 MOTTURA	 GWS1 	 GT4 GT4R 	 CM2 CM2R 	 GT1 GT1R

PER: FOR:	GIOBERT	GIBBONS	GIP	GIUSSANI
	308 	168 	46 	1384
	 GT3 E GT3R F 	 GN1 	 GP1 	 GS17

PER: FOR:	GIUSSANI				
	22 207	558 1590	2 	2 	2
	 GS1 GS4R E...9001-9741 SM1R GS9 	 GS1R GS4 E...3001-3480 SM1 9001-9741 G... 3001-3480 3001-3480 G...9001-9741 G...0-480	 GS13 1-2-3-4 	 GS3 GS3R GS2 GS2R 	 GS10 GS10R
	 CAB - ELSA - ELVOX PLG - SIMECA 	 OAL - LUME 	 BRETER 	 FBC - MLP 	 METALCASTELLI

PER:
FOR:

GIUSSANI

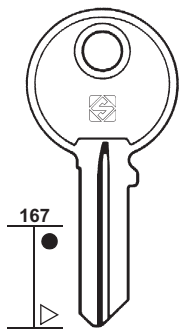

GS12R

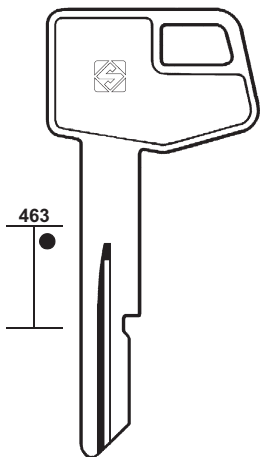

GS11R

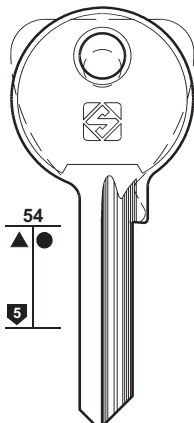

GS5 GS6

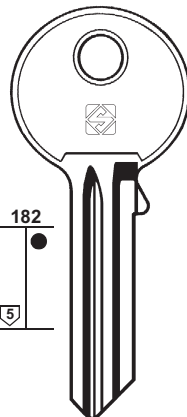

GS8

PASTORE

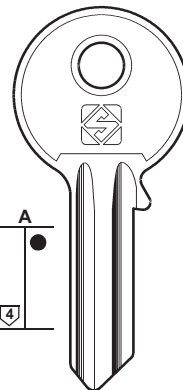

GS7



87

PER / FOR

GIUSSANI (I)
BANKA
MLP
PASTORE
+ BRETER (34)
+ TITAN (167)

GLAZIEV (RUS)

GLOBAL (GB)

GLOBE (RC)
ANLO
GOLD-DOOR
LARK
LUCO
MIAN-FORCE
SOF
WHALE
+ GOLD DOOR (89)
+ HILLO (93)

PER:
FOR:

GLAZIEV

GLOBAL

GLOBE

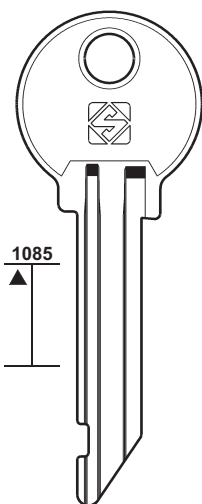

GLZ1

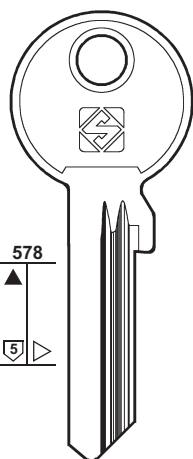

GBL1R

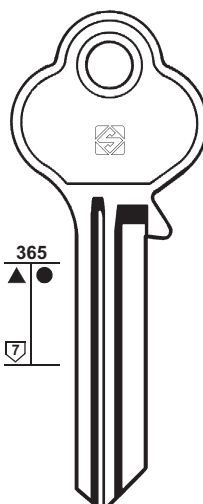

GL8

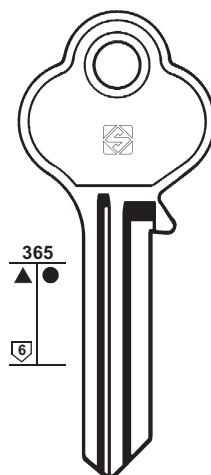

GL7 GL7R

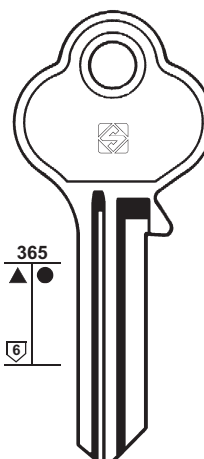

GL6 GL6R



PER:
FOR:

GLOBE

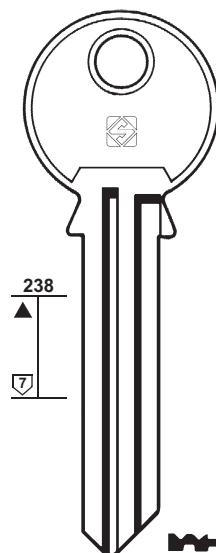

GL11R

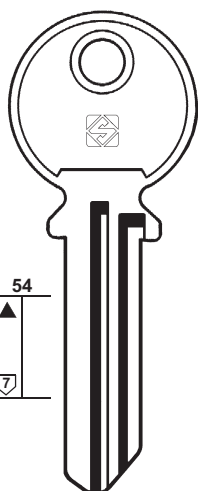

GL12R

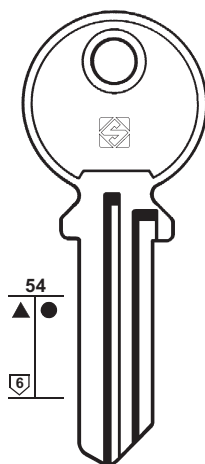

GL13R

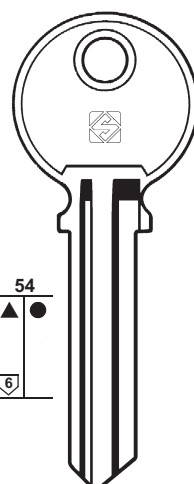

GL9 GL9R

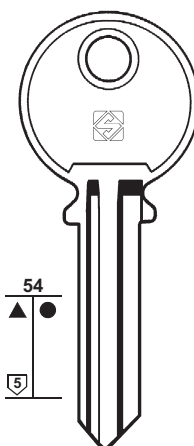

GL10 GL10R ●





88

PER / FOR

GLOBE (RC)

DOFIN

FTH

GOLD-DOOR

IFAM

SOF

+ GOLD DOOR (89)

+ HILLO (93)

GLOSTAL (D)

+ GEGE (84)

GOAL (J)

+ GSS (90)

PER:
FOR:

GLOBE

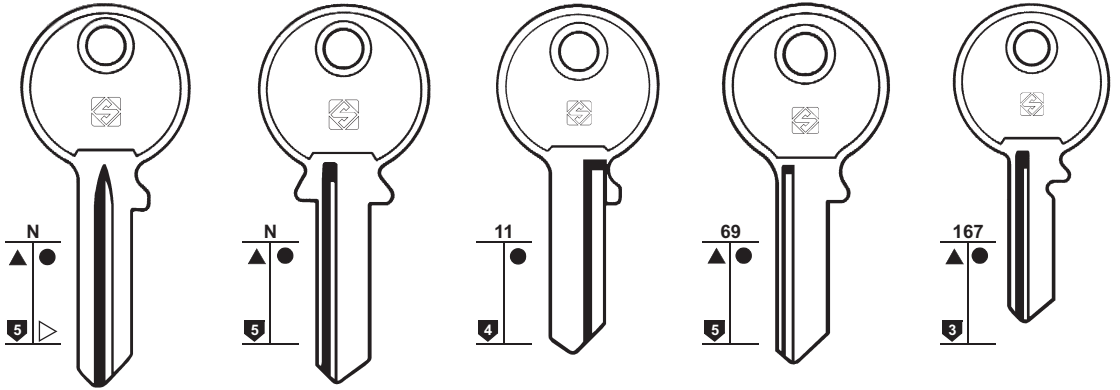

GL4



GL3R



GL5



GL2R



GL4R



GL3



GL5R



GL17R



GL2



DOFIN - FTH
GOLD DOOR
SOF



IFAM

PER:
FOR:

GLOBE

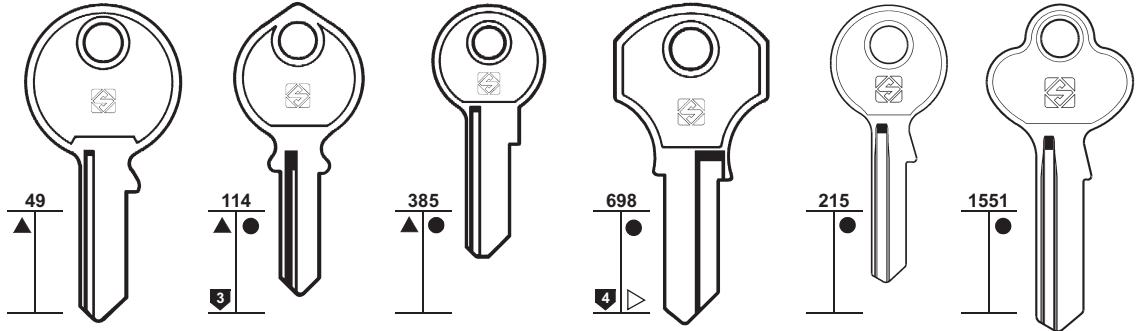

GL18R



GL1R



GL1



GL19R



GL14



GL21R



GL22R



GOLD-DOOR



PER:
FOR:

GOAL

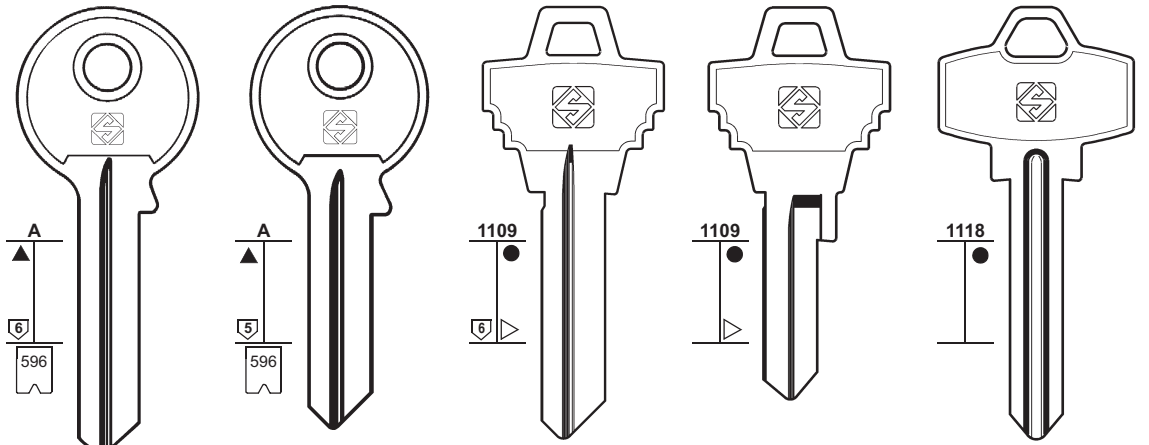

Y.....
1-2-3-4-5-6-7

Y.....
1-2-3-4-5-6-7



GO2R



GO1R



GO4R



GO3



GO5

PER: FOR:	GOAL	GODREJ	GOLD
	<p>1378 S547 S731 S884 GO6</p> <p>1378 S548 S877 GO7</p>	<p>GJ3</p>	<p>62 GOD4R</p>



89

- PER / FOR
- GOAL (J)**
+ GSS (90)
 - GODREJ (IND)**
 - GOLD (BRA)**
 - GOLD-DOOR (RC)**
GLOBE
+ GLOBE (87-88)
 - GOLLOT (F)**
RONIS (146)
 - GOTTA (D)**
FTH (82)
 - GÖTZ (D)**
KFV (105)
 - GP (I)**
 - GPR (F)**
FTH (82)
 - G.R. (F)**
(GUERVILLE-RIQUIER)
DEBEURAIN
MONDIAL
SE

PER: FOR:	GOLD DOOR	GP	G.R. (GUERVILLE RIQUIER)
	<p>56 GL20</p> <p>GLOBE</p>	<p>1129 GPI1</p>	<p>717 RIQ10R</p>

PER: FOR:	G.R. (GUERVILLE RIQUIER)	
	<p>53 302 RIQ3 RIQ2</p> <p>R 1234567890 F 1234567890 G 1234567890</p> <p>RIQ6S Y 1234567890</p> <p>MONDIAL</p>	<p>54 RIQ8 RIQ8R</p> <p>RIQ7 RIQ7R</p> <p>DEBEURAIN - SE</p>
	<p>52 302 RIQ1 RIQ1R</p> <p>Z 1234567890 T 1234567890 1234567890 XT 1234567890 Y 1234567890</p> <p>DEBEURAIN - SE</p>	



90

PER / FOR

G.R. (F)
(GUERVILLE-RIQUIER)
ABUS
BRICARD
PERRIER

GRAF (D)
KfV (105)

GRAYHILL (USA)
ILLINOIS (96)

GRIFO (RC)

GRUNDMANN (A)
GEGE (84)

GS (GR)
STAR (161)

GSA (I)
CAS-CISMA (40)

GSS (J)
GOAL

GTV (D)
JOWIL
TIEFENTHAL
+ CISA (48)
+ EMR (69)
+ JOWIL (100)

GUARD (HK) (CZ)
ABUS
EKLA
ROYAL
+ ABUS (8)
+ FAB (74)

PER:
FOR:

G.R. (GUERVILLE RIQUIER)

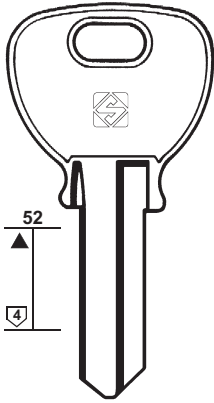

52
4



RIQ5



RIQ5R

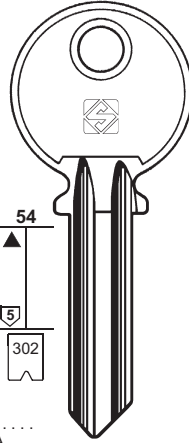

54
5
302



RIQ4



RIQ4R

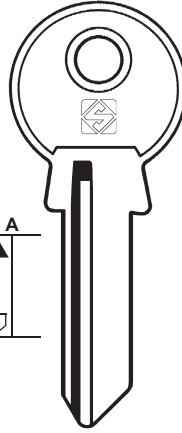

A
5



RIQ9



RIQ9R

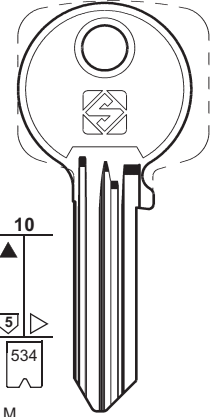

10
5
534



RIQ11



RIQ11R

.....
A.....
1-2-3-4-5-6-7-8-9-0

M.....
P.....
S.....
1-2-3-4-5-6-7-8-9-A-B-C-D-E-H-K-L

PERRIER

BRICARD - PERRIER

ABUS - BRICARD

PER:
FOR:

GRIFO

GSS

GTV

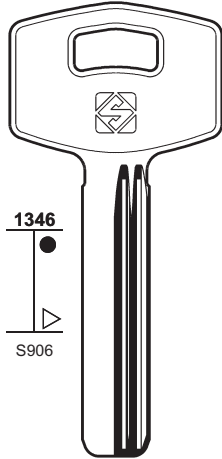

1346
S906



GF1

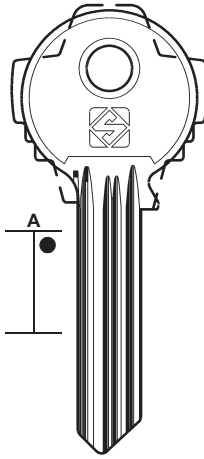

A



GSS1

GOAL

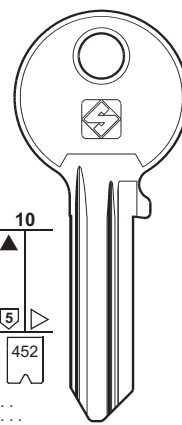

10
5
452

.....
0-1-2-3-4-5-6-7-8-9



GV1



GV2



GV3



GV4R



GV5R



GV6R

TIEFENTHAL

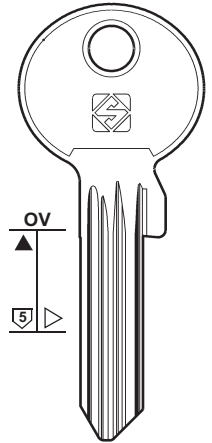

OV
5



GV7

JOWIL - TIEFENTHAL

PER:
FOR:

GUARD

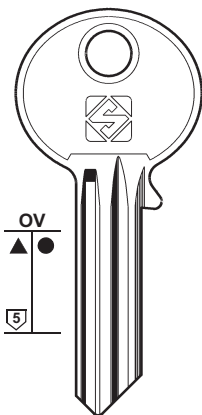

OV
5



GD8



GD8R

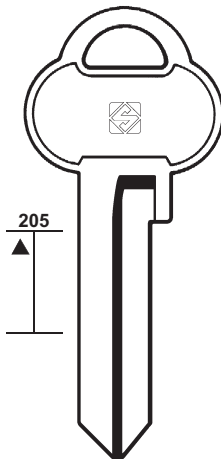

205



GD5

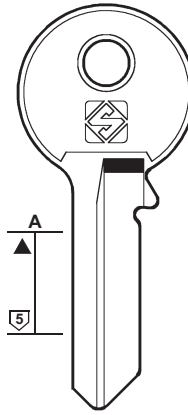

A
5



GD2

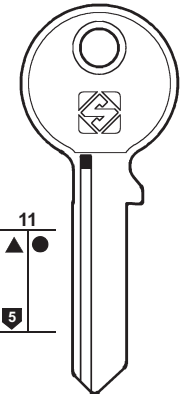

11
5



GD4



ABUS - EKLA - ROYAL

PER:
FOR:

GUARD

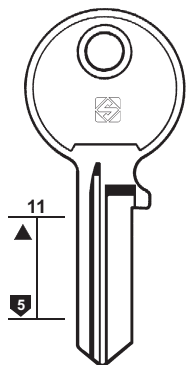

GD6R

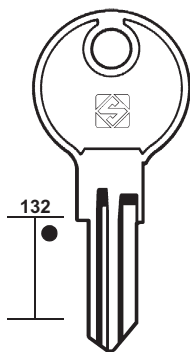

GD3

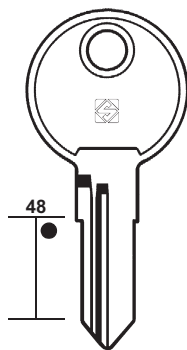

GD7R

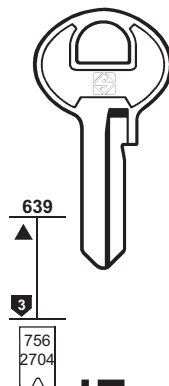

AB23

... 1-24
... 65/251-2-3-4-5

AB23R



GD1

GD1R



91

PER / FOR

GUARD (HK) (CZ)
ABUS

+ ABUS (8)
+ FAB (74)

GUARDIAN (I)

+ CAS-CISMA (40)
+ F.F. (78)

GUARUP (BR)

GUSHENG (CHN)

GUIDOTTI (F)

+ RONIS (146)

GUITTEL (F)

+ ABUS (8)

GÜTLER (D)

+ SIMECA (155)

HÄFELE (D)

+ BKS (30)
+ CES (41-42)
+ DOM (61-62)
+ HUWIL (94)
+ KIFERM (106)
+ LAS (110)

HAGA (BR)

HAIDE (RC)

+ YETI (198-199)

HALLE (D)

+ BAB (26)

HAMPTON (GB)

+ MASTER (119)

HANNO (D)

+ CES (41-42)

HARLOC (USA)

+ EAGLE (67)

PER:
FOR:

GUARUP

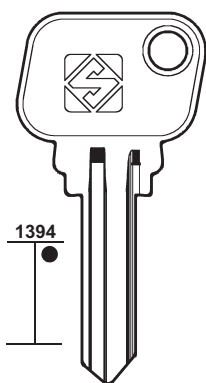

GUR1

GUSHENG

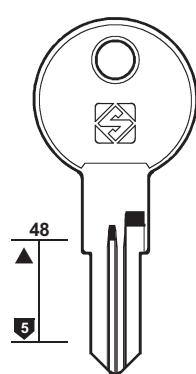

GUS1

HÄFELE

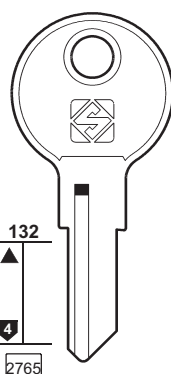

HF1R

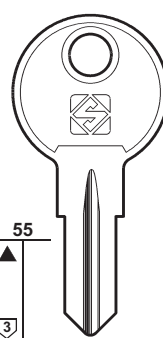

HF73R

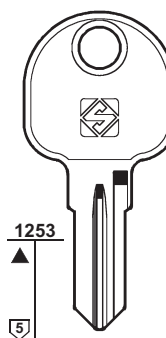

HF74 **HF74R**

PER:
FOR:

HÄFELE

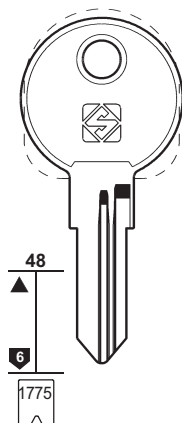

HF75

HF75R
... 1-3936

HAGA

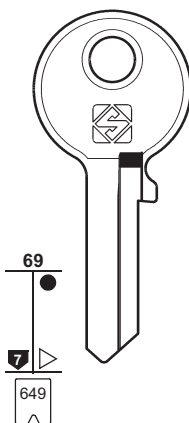

HAG1

HAG1R

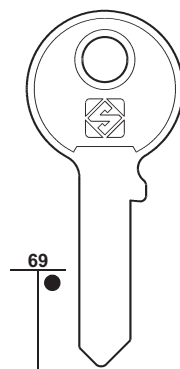

HAG6R

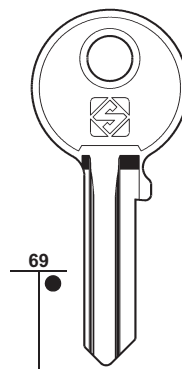

HAG7

HAG7R

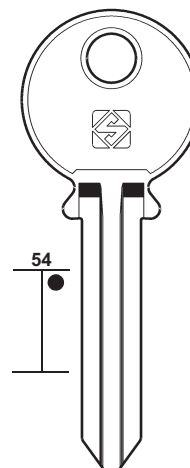

HAG5



92

PER / FOR

HARP (HK)

HASLER (D)
+ SEA (152)

HASMAN (IND)

HB (I)
 LEGALLAIS (111)

HBC (D)
 MELSMETALL (122)

HDL-PACRI (BR)

HECTOR (E)

HEGO (D)
 CORBIN (53)

HEKNA (D)
METALCASTELLI
RAUCO
REGENT
+ DOM (61)
+ HR (93)

HEL (E)

HEMA (RC)
 VACHETTE (181)

HEMY (F)
 YETI (198-199)

PER: FOR:	HARP	HASLER	HASMAN	HDL-PACRI

PER: FOR:	HDL-PACRI	HECTOR	HEKNA
		 1001-1425 C..... 1251-1700 1001-1425
			METALCASTELLI - RAUCO REGENT

PER: FOR:	HEKNA	HEL
 1-2-3-4 1501-1540	

PER: FOR: HENDERSON	HILLO	HK	HOK	HOPPE
 167 4 272	 11 5	 49 4	 1434 5	 1261 5 1643
 HEN1 R... 008-254	 HL1R mm 40	 H1 H1R mm 20	 HOK1R 	 HPP1 HPP1R ... 1001-3187
REAGENT	GLOBE - HERO			BURG - KIND - MAUSER

PER: FOR: HORSE	HR	HTV
 438 5	 521 5	 132 1809 E... 1-698
 HO1R	 HO2R	 HR1 E
		 HT1 HT1R 07
		 HT2 04
	HEKNA - HERO - OJMAR	VAUGHN SHAW - VAUGHN - YALE

PER: FOR: HUDSON	HUGIN	HUGO
 132 5 142	 11 1037	 178
 178	 178	 178
 616	 1219	 1219
 HD8R ▲	 HD1R	 HD1
 HD2	 HD2R	 HG1 A
A... 201-1050 C... 500-699 H... 601-1100 HM... 201-1050	 HG2 A	 HG3 P
	HUGIN (S)	HUGO (D)

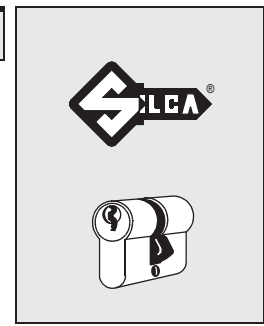

93

- PER / FOR**
- HENDERSON (GB)**
REGENT
+ UNION (176)
 - HERMES (RC)**
YETI (198-199)
 - HERO (D)**
HILLO (93)
HR (93)
 - HESTE (D)**
CORBIN (53)
 - HILLO (RC)**
GLOBE
HERO
 - HK (D)**
 - HMP (RC)**
ALPHA (15)
 - HOBBY (GB)**
EURO LOCKS (71)
 - HÖHRMANN (D)**
BKS (30)
CES (42)
DOM (62)
GEGE (84)
 - HOK (TR)**
 - HOPPE (D)**
BURG
KIND
MAUSER
+ BURG (38)
 - HOOPLY (PRC)**
WANJIN (188)
 - HORSE (RC)**
 - HR (D)**
HEKNA
HERO
OJMAR
 - H.R.S. (F)**
TH (166)
 - HSA (D)**
KFV (105)
 - HTV (GB)**
SHAW
VAUGHN
YALE
 - HUDSON (USA)**
+ FORT (81)
+ SEGAL (153)
+ YALE (194)
 - HUGIN (S)**
 - HUGO (D)**



94

PER / FOR

HUNIT (I)

+ FTH (82)

HUTRA (D)

+ SCHLECHTENDAHL (152)

HUWIL (D)

CEKA
CHRIST
HÄFELE
L.M.C.
MAUSER
SCHÄRF
STEELCASE
STRAFOR
WILLACH
WÜRTH
+ BOMORO (33)
+ DOM (61)

IALEX (P)

IBFM (I)

+ L & F (116)

ICA (E)

ICSA (I)

ORLANDO
REMO
ZANI
+ LINCE (112)

IDEAL (RC)

+ DOM (61)

IDEAL SECURITY (USA)

+ WEISER (189)

IDRO STOP (I)

CEV

PER: HUNIT
FOR:

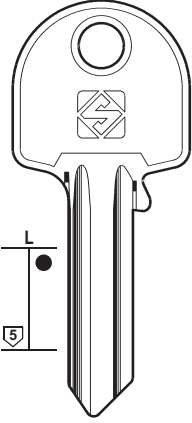

HUT1

HUWIL

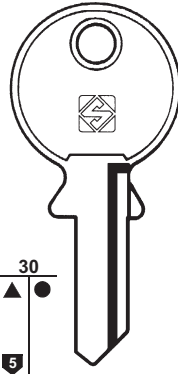

HW1

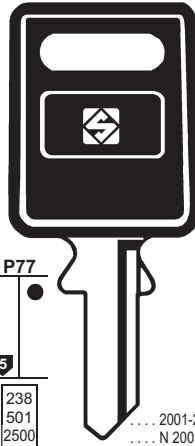

HW1P

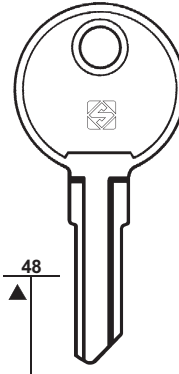

HW2
R



HW3
V

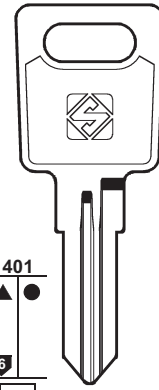

HW4

HW4R

- ... 000-051
- ... 0001-1915
- ..0A-9Z
- IG. 14101-16020
- 22001-23920
- DE. 25500-27419
- A 3001-4000
- W. 3001-4000
- 3001-4001
- 3010-3999
- 3202-4004
- A 5001-5050
- A. 5001-5050
- 5001-6169
- 7000-8001
- PL. 7420-8419
- RA. 7480-8479
- 7526-7726
- FH. 7526-7726
- 8001-8321
- 8001-9541
- LH 8701-9700
- UO. 9000-9999

CHRIST - HÄFELE - L.M.C.
WILLACH - WÜRTH

HÄFELE
STRAFOR - STEELCASE

PER: HUWIL
FOR:

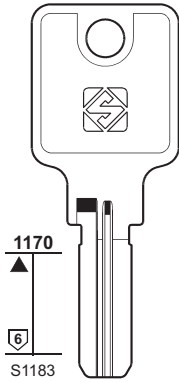

HW15R

CEKA - HÄFELE
MAUSER - SCHÄRF

IALEX

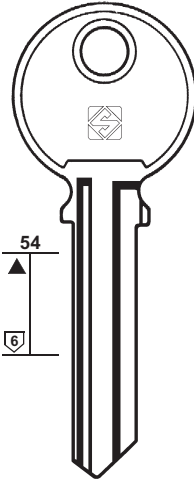

IX1 IX1R

IBFM

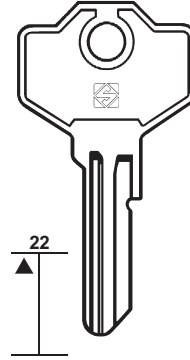

IBF1 IBF1R

ICA

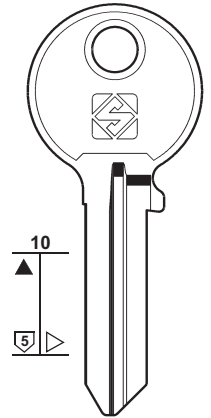

ICA1R

PER: ICSA
FOR:

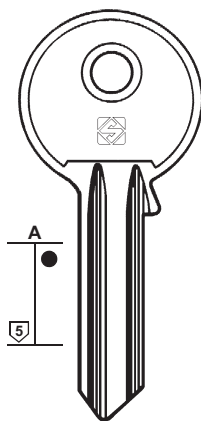

ICS1 ICS1R

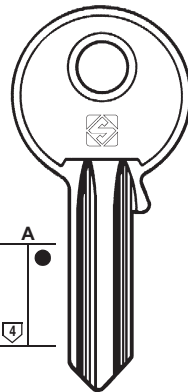

ICS3
ICS2 ▲ICS2R

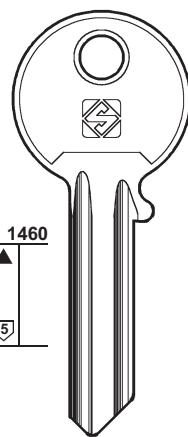

ICS5

ORLANDO
REMO - ZANI

IDRO-STOP

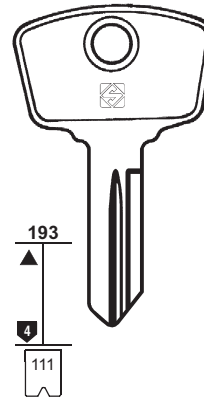

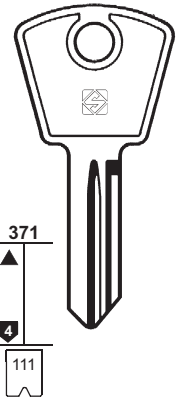

ISP2
.. 1-78



ISP4
.. 1-78



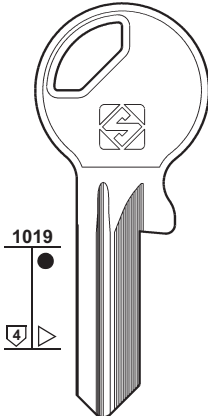
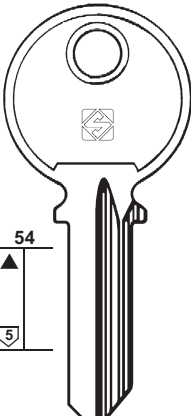
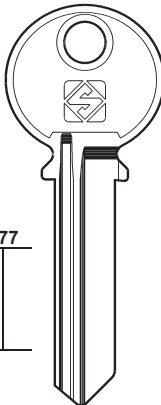
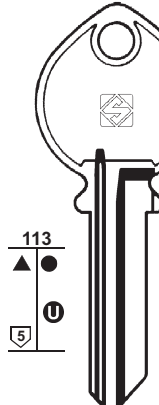
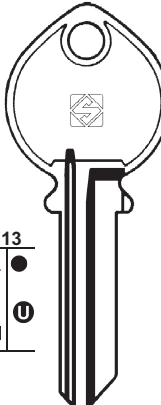
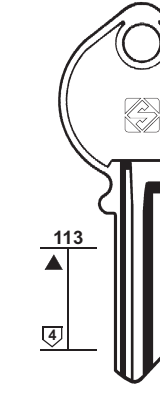
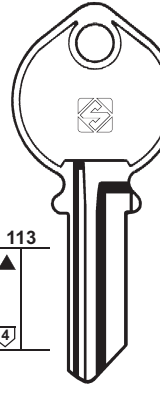
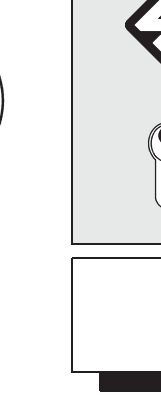

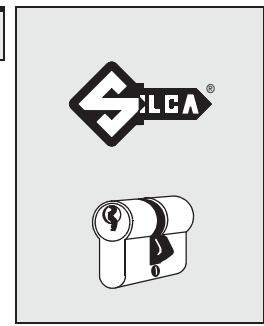

CEV







PER: FOR:	IES	IFAM					
 <p>1019</p> <p>4</p> <p>IES1R</p>	 <p>54</p> <p>5</p> <p>IF1</p>	 <p>477</p> <p>IF7</p>	 <p>113</p> <p>5</p> <p>IF7R</p>	 <p>113</p> <p>5</p> <p>IF3</p>	 <p>113</p> <p>4</p> <p>IF3R</p>	 <p>113</p> <p>4</p> <p>IF2</p>	 <p>113</p> <p>4</p> <p>IF2R</p>
				 mm 45-50-55	 mm 35-40 RIPA		













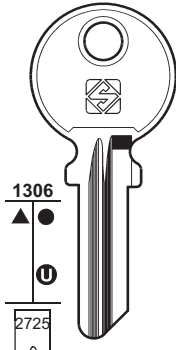
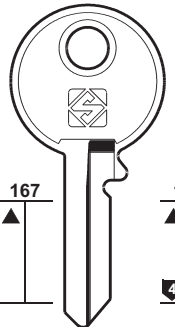
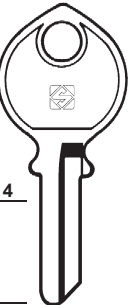

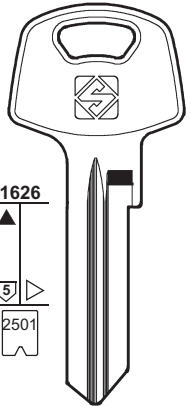
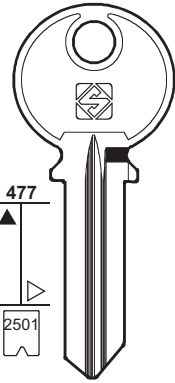
95



- PER / FOR**
- IES (I)**
- IFAM (E)**
 BATU
 JOMA
 RIPA
 TEM
 +  BUGA (36)
 +  CHICAGO (46)
 +  CISA (50-51)
 +  FTH (82-83)
 +  GLOBE (88)
 +  ISEO (97)

- IGS (F)**
- IJ (F)**
 JTF
 +  JTF (100)
 +  MERONI (124)
 +  STAR (161)

- IJN (F)**
 KIFERM (106)

ILARGI (E)

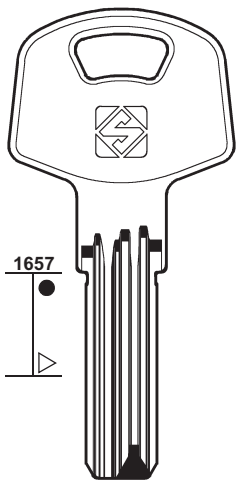
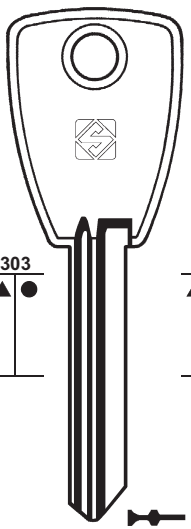
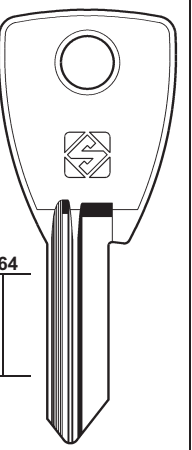
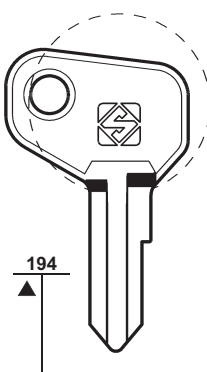
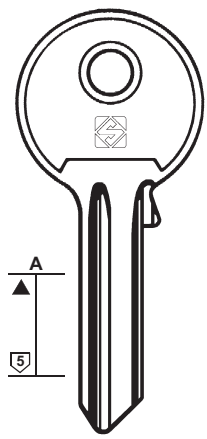
PER: FOR:	IFAM					
 <p>1306</p> <p>2725</p> <p>IF6 4001-4240</p>	 <p>167</p> <p>IF8</p>	 <p>114</p> <p>4</p> <p>IF4</p>	 <p>114</p> <p>3</p> <p>IF5</p>	 <p>1626</p> <p>2501</p> <p>..... (D) 0123456 (D) 55002-58124</p> <p>IF12R</p>	 <p>477</p> <p>2501</p> <p>..... (D) 0123456 (D) 55002-58124</p> <p>IF13R</p>	
	 IF8R	 IF4R	 IF5R	 IF12R	 IF13R	
	 JOMA	 JOMA	 mm 25 BATU - RIPA - TEM	 mm 20 JOMA - TEM		

PER: FOR:	IFAM	IGS		IJ	ILARGI
 <p>1657</p> <p>IF14</p>	 <p>303</p> <p>IS2</p>	 <p>264</p> <p>IS1</p>	 <p>194</p> <p>IJ1</p>	 <p>A</p> <p>5</p> <p>IL1R</p>	 IL1
				 JTF	



96

PER / FOR

ILCO (USA)
BARGMAN

ILLINOIS (USA)
DUO
GRAYHILL
LAGRANGE
OTIS
SEEBURG
+ CHICAGO (45)

ILS (I)
+ FASEM (77)

IMAB (BR)

IMBAC (F)
PREFER (143)

IMP (D)
ABUS (8)

IMSI (I)
PERINO (140)

INDAUX (E)
FAC (75)

INDESIT (I)
ELSI
MIT
RECA

INGERSOLL (GB)

PER:
FOR:

ILCO

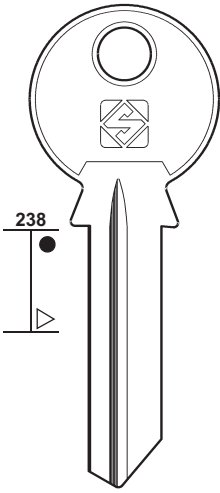

ILC13R

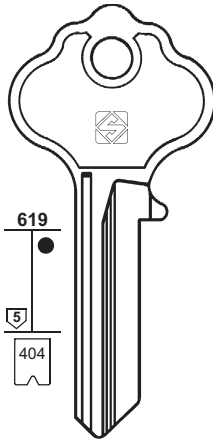

ILC2

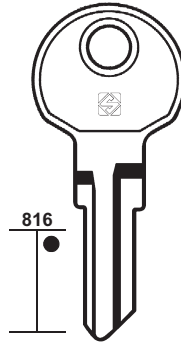

ILC6

BARGMAN

ILLINOIS

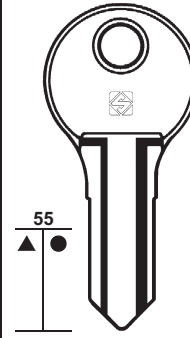

IN1



NUOVO PIGNONE
GRAYHILL - LAGRANGE
OTIS - SEEBURG

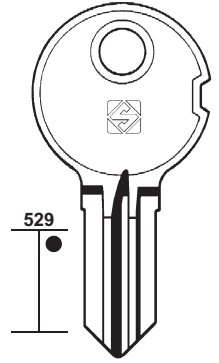

IN2
H

IN3
J



PER:
FOR:

ILLINOIS

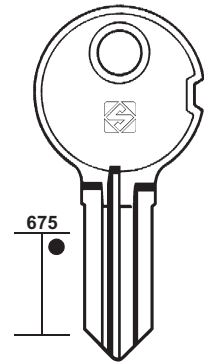

IN5



DUO

ILS

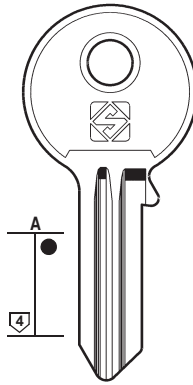

ILS1



IMAB

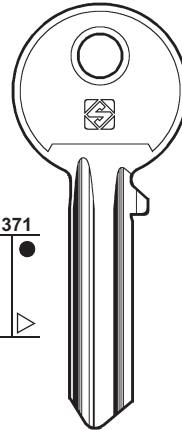

IAB7

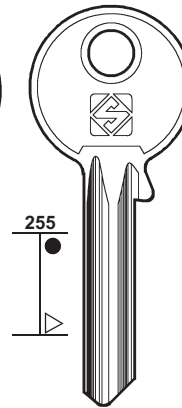

IAB8

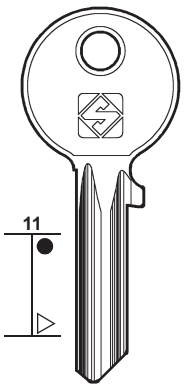

IAB9

PER:
FOR:

INDESIT

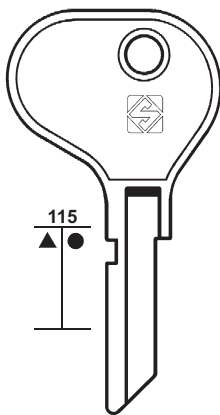

ID1
REG

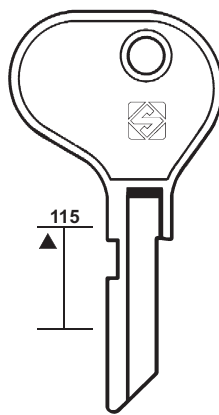

ID2
X

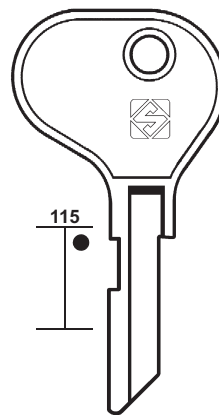

ID3
MGR



INGERSOLL

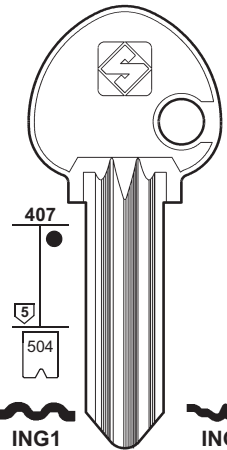

ING1
A 1-2-3-4







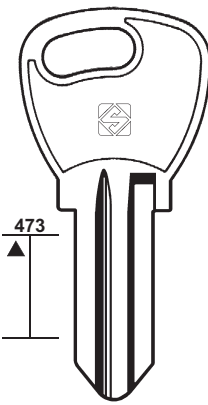
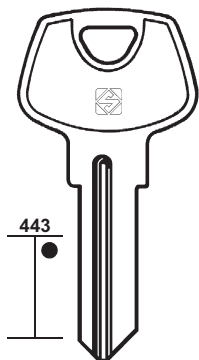

ING5
S 1-2-3-4

ING2
W

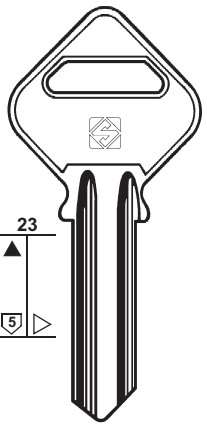
ING6
N

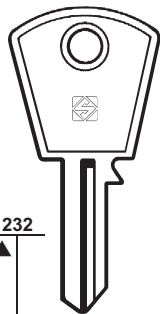





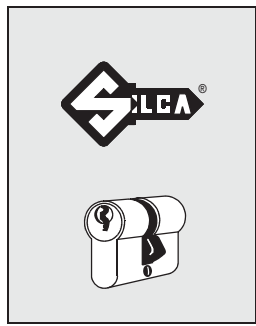





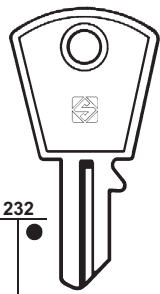



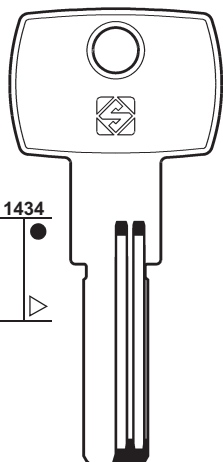

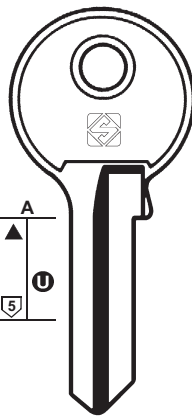

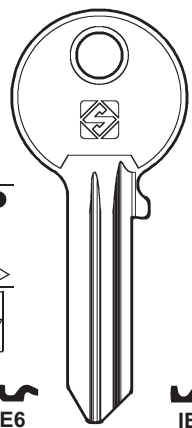

ELSI - MIT - RECA











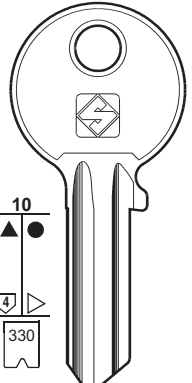

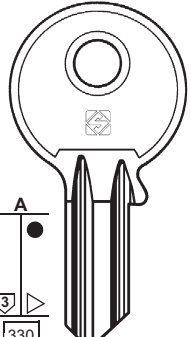

PER: FOR:	INGERSOLL	INSA	INT
	 473  443  ING3  ING4R	 23  INS1	 232  IT1  IT1R 

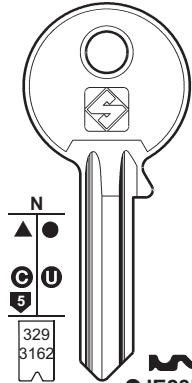

97

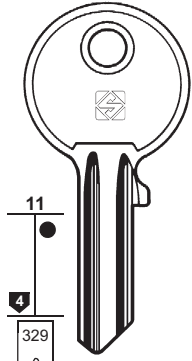
- PER / FOR
- INGERSOLL (GB)
 - INLOC (F)
 - BRICARD (35)
 - INSA (I)
 - INT (I)
 - I.R. (F)
 - DOM (63)
 - W.M.S. (192)
 - ISABEL FAINER'S (P)
 - ISEO (I)
 - CAM
 - IFAM
 - STAR
 - VACHETTE (180)

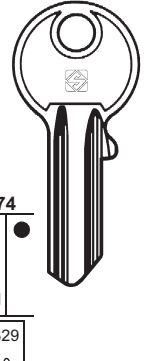
PER: FOR:	INT	I.R.	ISABEL FAINER'S	ISEO
	 232  IT2  IT2R 	 1434  IR1 	 A  IB1 	 10  IE31  IE27R F3 0-1-2-3-4-5-6-7-8-9  IE13  IE12  IE10  IE6 IFAM - STAR 012345678 LCE 1-17513 Y 1-2000 Y0 1-2000  IE6R 012345678 KFC 1-28800 1-6516  IE2 1-2000 0-1-2-3-4-5-6-7-8  IE2R 1-2000 0-1-2-3-4-5-6-7-8  IE9 1-2000 ME 1-210 CAM  IE10 1-2000 ME 1-210 CAM

PER: FOR:	ISEO				
	 10  IE7  IE7R  IE224  IE225 0-1-2-3-4-5-6-7-8	 A  IE8  IE8R 0-1-2-3-4-5-6-7-8	 N  IE3  IE3R 1-2-3-4-5-6  IE1  IE1R 1-2-3-4-5-6	 11  IE4  IE4R 1-2-3-4-5	 74  IE5 1-2-3-4-5



98

PER / FOR

ISEO (I)
ATRA
CITY
VACHETTE
+ VACHETTE (180)

ISSERSTEDT (D)
CORBIN (53)

ITALBLOCK (I)
EUREKA (70)

ITO (TR)
CISA (48)
FTH (83)

ITOKI (J)

IULIA MAS FED (I)
FASEM (77)

PER:
FOR:

ISEO

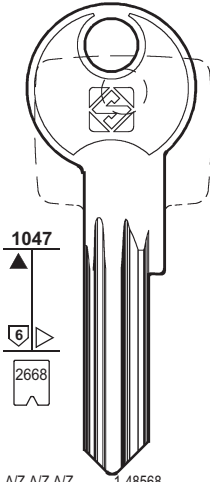

1047
6
2668

A/Z A/Z A/Z 1-48568

F6
IE29

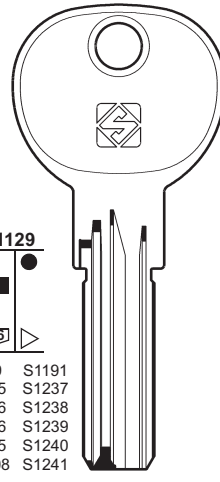

1129
5+6+6

S99 S1191
S725 S1237
S726 S1238
S916 S1239
S965 S1240
S1108 S1241

EDL
CFA 1-27065
EDL 1-350589
ECA 1-050000
ECA 100001-150000
EDA 1-350589
EDY 1-350612
EGE 1-027508
EGE 100001-127508
EGE 200001-227508

HNH
IE14
R11

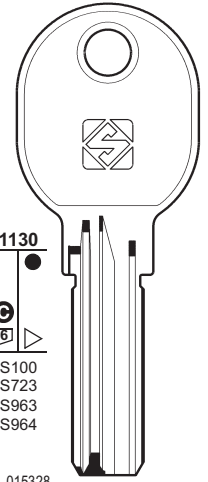

1130
5+6+6

S100
S723
S963
S964

ABL 1-015328
ACY 1-015328
AGL 1-015328
ABF 1-015694

HNH
IE15
R6



CITY - VACHETTE

PER:
FOR:

ISEO

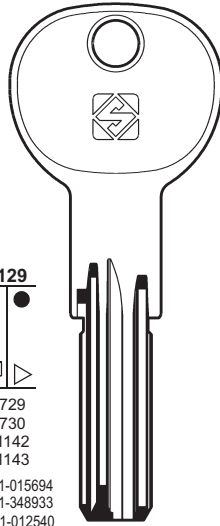

1129
5+6+6
S729
S730
S1142
S1143

AAC 1-015694
DAA 1-348933
AMB 1-012540
AMB 100001-112540

HNH
IE26



ATRA - CITY

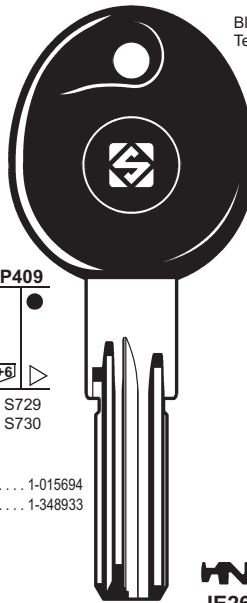

P409
5+6+6
S729
S730

AAC 1-015694
DAA 1-348933

HNH
IE26P

Blue head
Testa blu

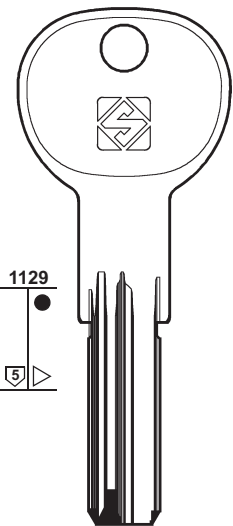

1129
5

HNH
IE30



PER:
FOR:

ITO

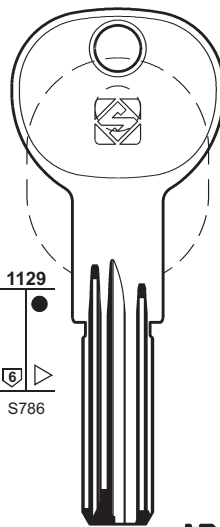

1129
6
S786

HNH
IO1



ITOKI

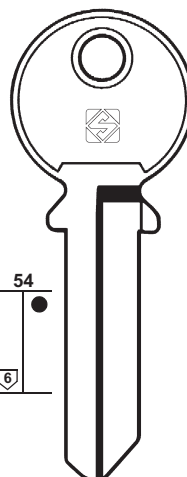





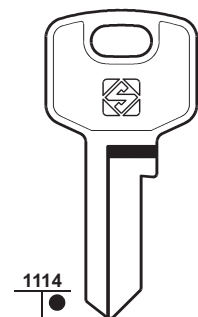

54
6

HNH
ITO1R ITO2 ▲

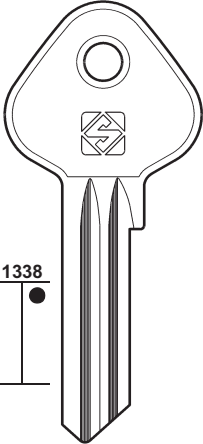
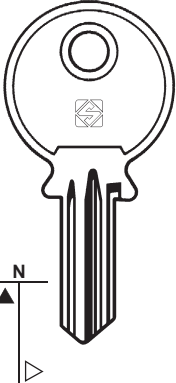
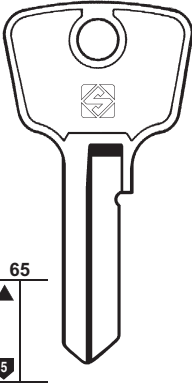
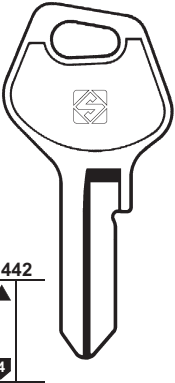

1114





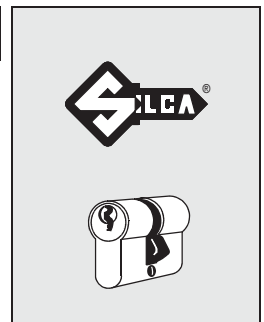

HNH
ITO3 ITO3R



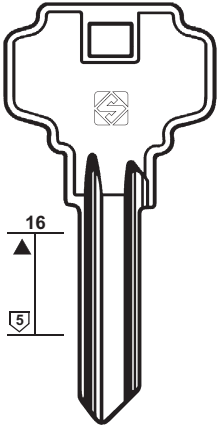
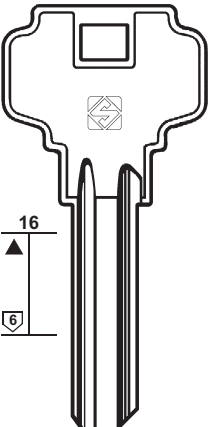
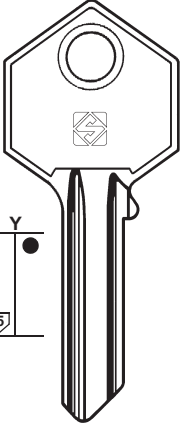





PER: FOR:	IWATA	JÄBA	JAPAN	
	 1338	 N	 65	 442
	 IW1R	 JB1	 JPN1  ● JPN2	 JPN3R 

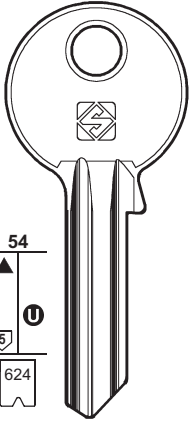
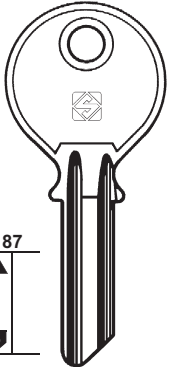
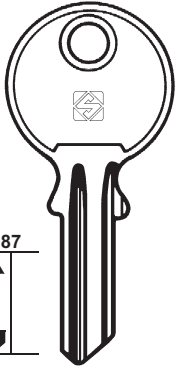
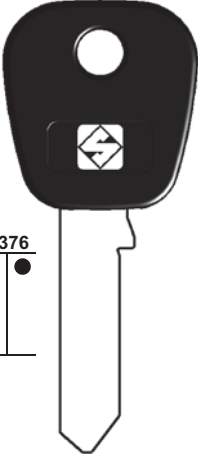

99

PER / FOR
IWATA (J)
JÄBA (DK)
JAPAN (J)
JARDI (E)
JD (J) 👁️ ALPHA (15)
JEHU (RC)
JET (D) 👁️ ABUS (7)
JIP (F) 👁️ PREFER (142) 👁️ RONIS (146-147)
JIS (E) SEMEL
JL (F) 👁️ FTH (81)
JMR (E) 👁️ EZCURRA (73)
JNF (IL) 👁️ EVERGOOD (71)
JOLY (F) 👁️ GABON (84)
JOMA (E) 👁️ IFAM (95)
JORE (D) 👁️ WILKA (191)
JOSTA (D) 👁️ CES (41-42)

PER: FOR:	JARDI	JEHU	JIS
	 16	 16	 Y
	 JAR1  JAR1R	 JH1  mm 60	 JS1  JS1R

PER: FOR:	JIS			
	 54	 87	 87	 P376
	 JS2  JS2R 0-1-2-3-4-5-6-7-8-9	 JS4  JS4R	 ● JS3  JS3R	 JS5P 

SEMEL



100

PER / FOR

JOWIL (D)

ESZ
FUHR
GTV
JÜNGST
MERCUR
OSKO
PANTHER
TIEFENTHAL
TRITON
VOKO
WEPA
+ EMR (69)

JPM (F)

+ ABUS (6-7)
+ CISA (49)
+ KESO (104-105)
+ SIMECA (155)

JTF (F)

IJ
+ IJ (95)
+ MERONI (124)

JU (D)

+ KIFERM (106)
+ VACHETTE (181)

PER:
FOR:

JOWIL

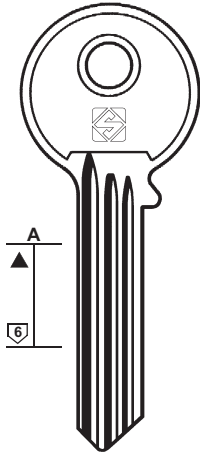

JOW8

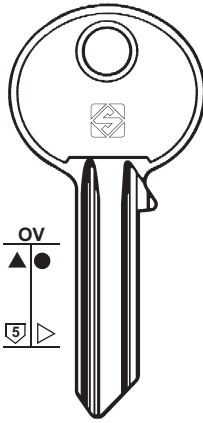

JOW1 JOW1R ▲

ESZ - FUHR - GTV
JÜNGST - MERCUR
OSKO - PANTHER
TIEFENTHAL
TRITON - VOKO - WEPA

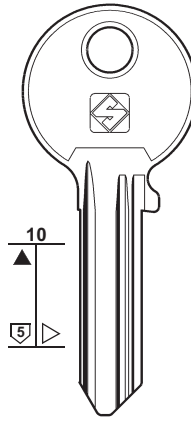

JOW2
 JOW5
 JOW6
 JOW7
 JOW9
 JOW10

JOW11

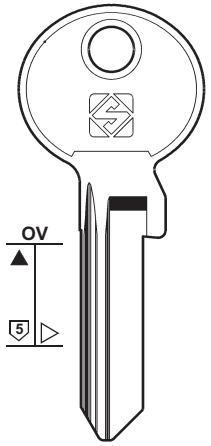

JOW12X JOW12RX

PER:
FOR:

JOWIL

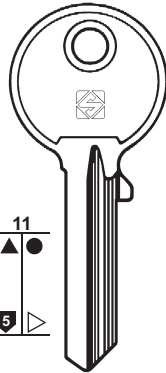

JOW3R

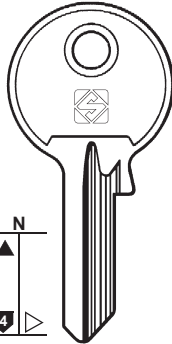

JOW4R

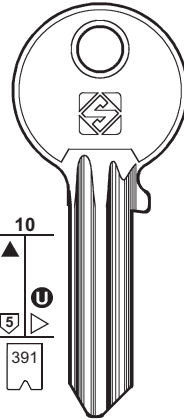

▲ JM3 JM3R ▲

A
X
1-2-3-4-5-6-7

▲ JM2 JM2R ⊕

JM1 ▲ ●

F3
AY
BA
BB
BC
BD
BD
BL
BM
BN
BP
BQ
BR
BS
BT
BU
BY
F3C
SA
SB
1-6032

JM1R ▲

F3
F3D
1-6032

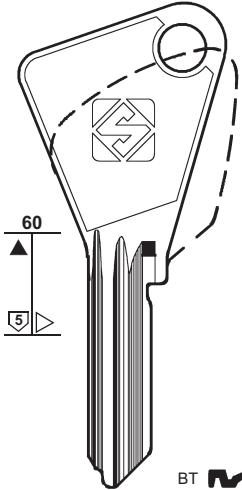

BT JM6

BK JM7

PER:
FOR:

JTF

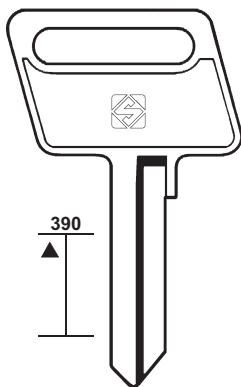

JT1
JA

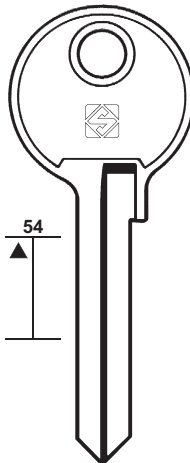

JT2R

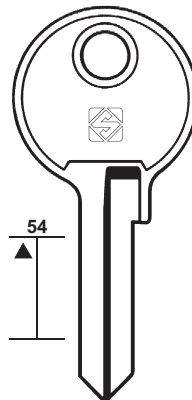

JT3R



JU

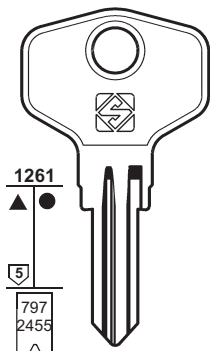

JU11 JU11R
D A
..... (A) 1-2-3 (D) 1-2-3
B ... (D) 376-500+(507-508) B ... (A) 001-125+(501-502)

JU12 JU13R
C B
..... (B) 1-2-3 (B) 126-250+(503-504)
B ... (C) 251-375+(505-506)



PER: **JUNGHEINRICH**
FOR:

JUNIE

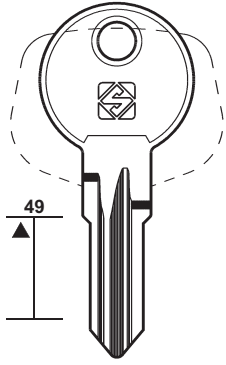

JR1R

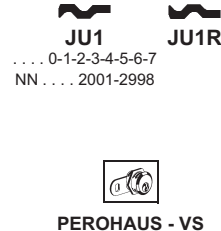
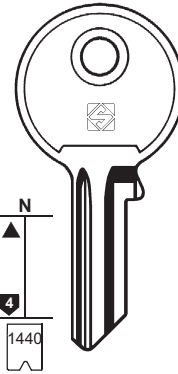
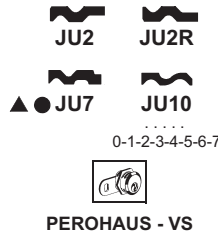
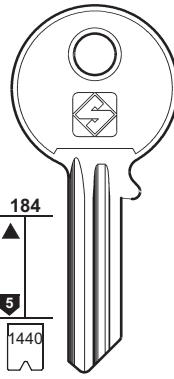
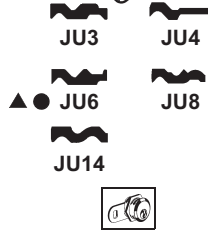
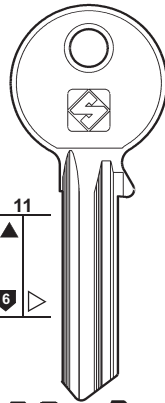

... 0-1-2-3-4-5-6-7
NN ... 2001-2998

0-1-2-3-4-5-6-7

PEROHAUS - VS

PEROHAUS - VS



101

PER / FOR

JUNGHEINRICH (D)

JUNGHWA (J)

JÜNGST (D)

👁️ **JOWIL (100)**

JUNIE (D)

PEROHAUS
VS

JUNKUNC (USA)

ALSO
AMERICAN
FEDERAL
LION

JUWEL (I)

+ 👁️ **FASEM (77)**

PER: **JUNIE**
FOR:

JUNGHWA

JUNKUNC

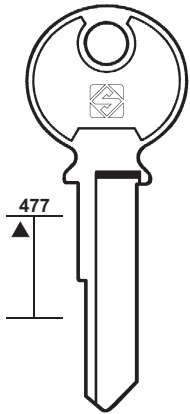

JU5

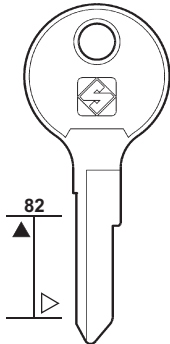

JU9

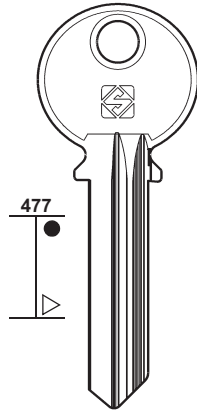

JN1R

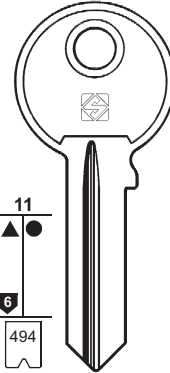

... 80000-88999

JC2R

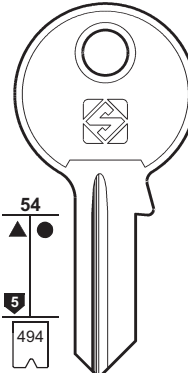

... 1-2-3-4-5-6-7-8

JC1



ALSO - AMERICAN - FEDERAL - LION



PER: **JUWEL**
FOR:

JUWEL

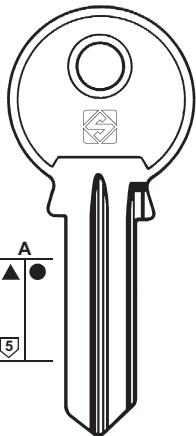

JW6 ●
5

JW7R ▲
10

JW8 ▲
51

JW9 ▲
52

JW4R ▲
2

JW12 ▲

JW5
3

JW13
16

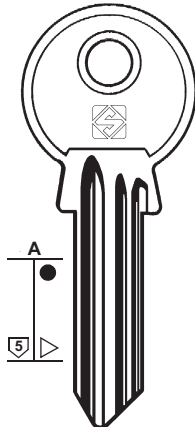

JW1R

JW1

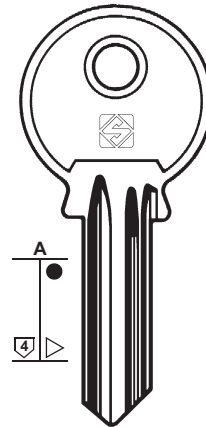

JW2R

▲ JW2



102

PER / FOR

JUWEL (I)
+ FASEM (77)

JVAL (P)
FEB
P.C.
SAVIO
+ P.C.
(CORTELLEZI) (140)

KABA (CH)
BORKEY
LÄSBOLAGET
PICARD

PER:
FOR:

JUWEL

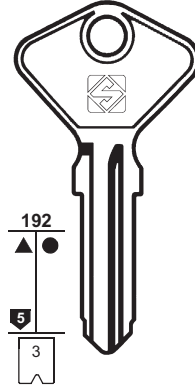
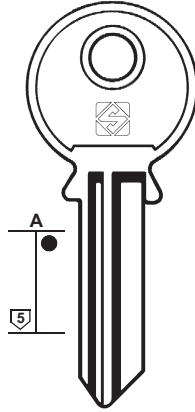
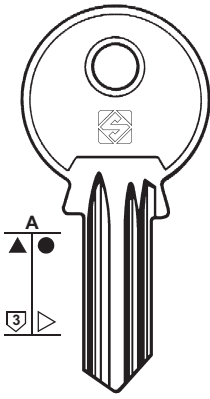

JVAL

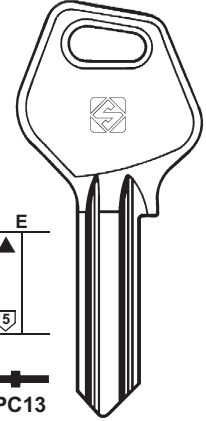

FEB - P.C. - SAVIO

PER:
FOR:

JVAL

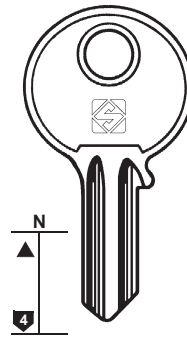
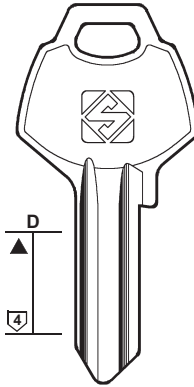
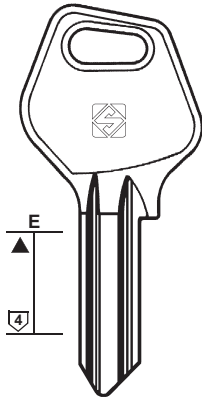

FEB - P.C.

FEB

KABA

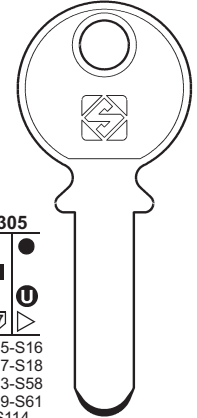

S15-S16
S17-S18
S53-S58
S59-S61
S114

PH....
0001-9000
... 1-200



LÄSBOLAGET

PER:
FOR:

KABA

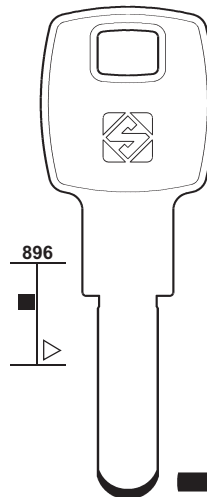
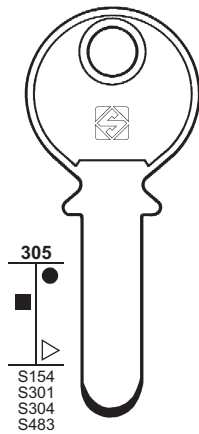

PICARD

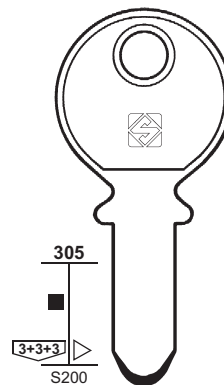

BÖRKEY

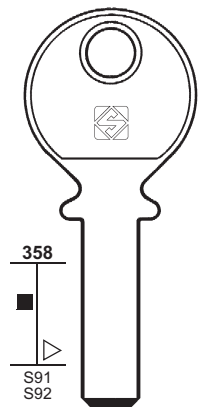

MINI KABA



PER:
FOR:

KABA



103

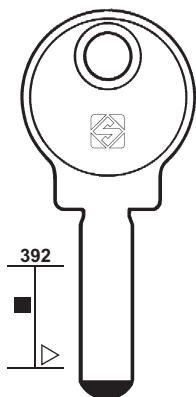

KA4

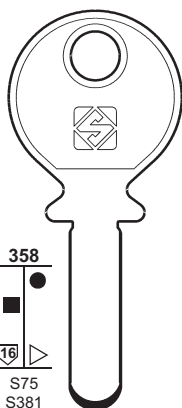

KA5

GEMINI



DORSET

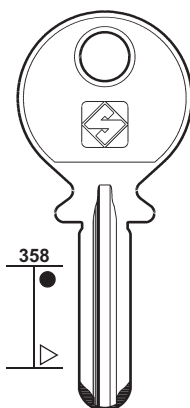

KA9

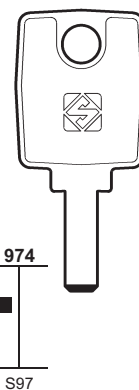

KA8

MICRO KABA



PER / FOR

KABA (CH)
DORSET

KAKEN (ROK)

KALE (TR)

- + ABUS (7)
- + BUVA (39)
- + TESA (166)

PER:
FOR:

KAKEN

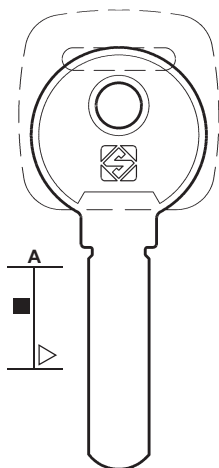

KAK1



KALE

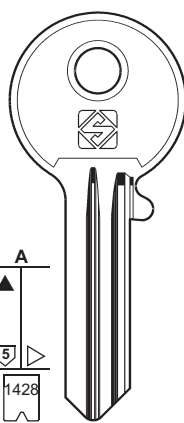

KLE3R

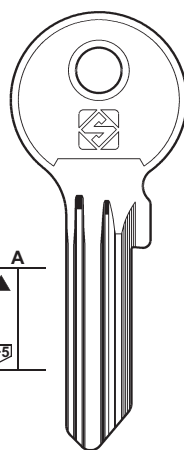

KLE3X

KLE3RX

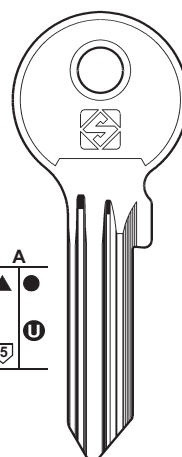

KLE6X

KLE6RX

..... 1-2-3-4-5-6-7-8-9

KLE5X

KLE5RX

KLE7X

KLE7RX

PER:
FOR:

KALE

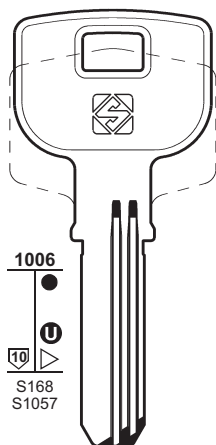

KLE1

KLE4

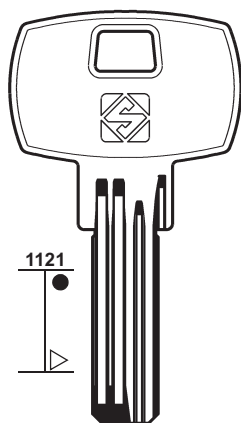

KLE2R

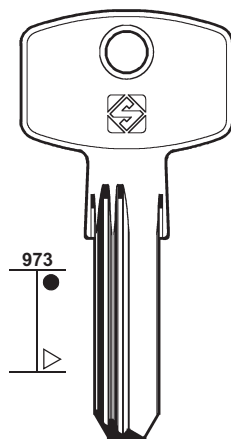

KLE8R

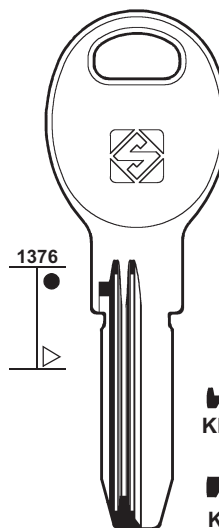

KLE10R

KLE9R





104

PER / FOR

KALUGA (RUS)

KARDEX (F)

👁️ CES (41-42)

👁️ RONIS (147)

👁️ VINCO (186)

KARO (E)

👁️ FTH (82)

KASPIJSK (RUS)

KATE (D)

👁️ SIMECA (155)

KAWE (D)

👁️ CORBIN (53)

👁️ TESA (165)

👁️ WEISER (189)

KAZAN (RUS)

KEIL (USA)

KESO (CH)

JPM

PER:
FOR:

KALUGA

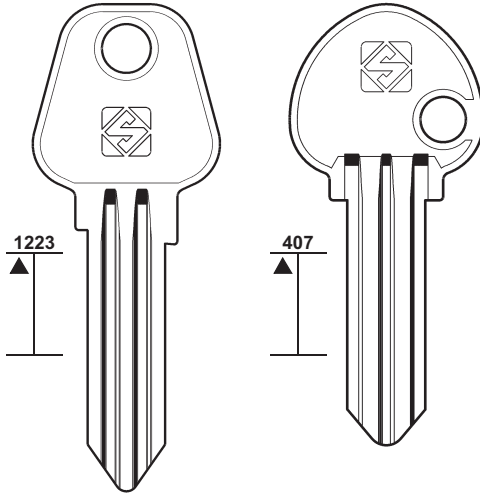

KLG1R

KLG2R

RUS2

KASPIJSK

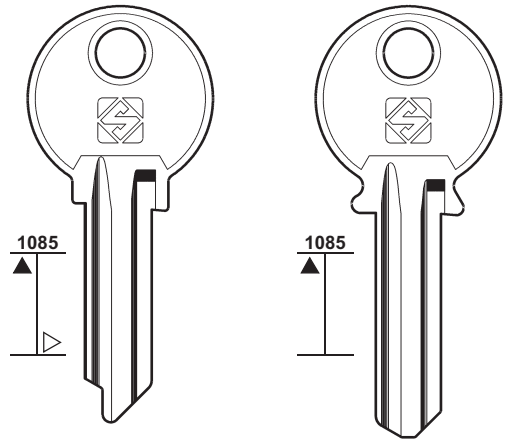

KAP1

KAP1R

RUS1

RUS1R

PER:
FOR:

KAZAN

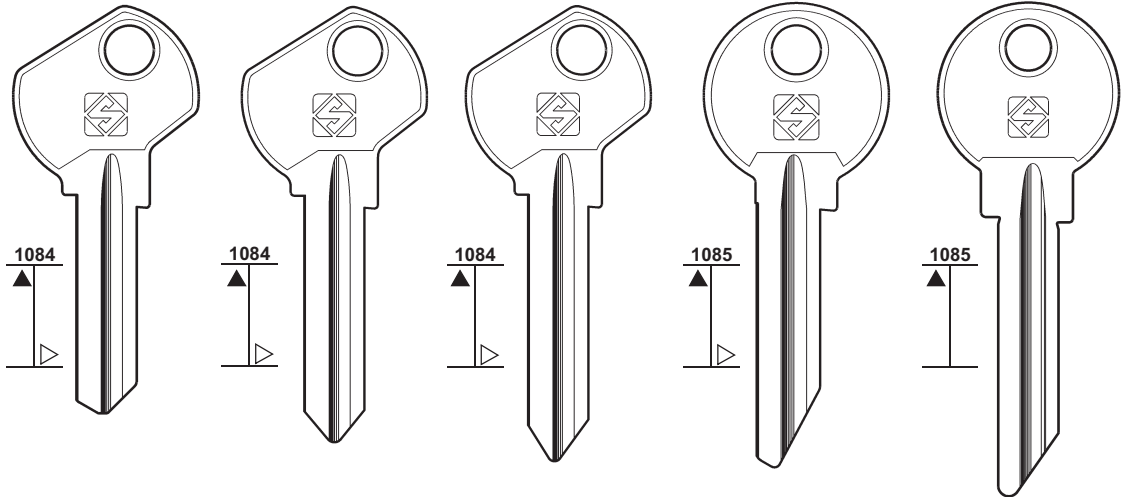

KAZ1R

KAZ4R

KAZ5R

KAZ2

KAZ2R

KAZ8R

PER:
FOR:

KAZAN

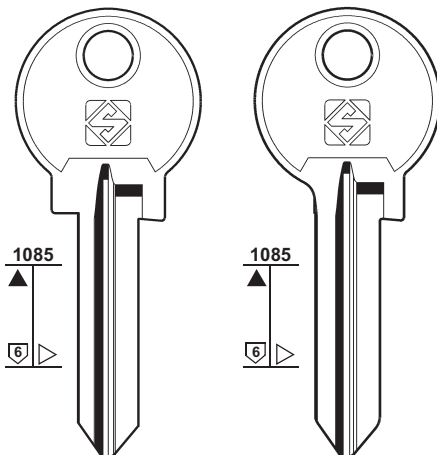

KAZ3R

KAZ7R

KEIL

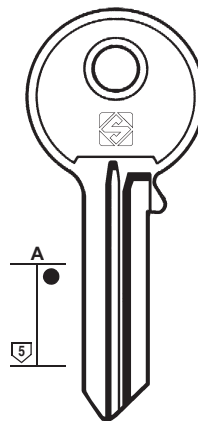

KEI1R

KESO

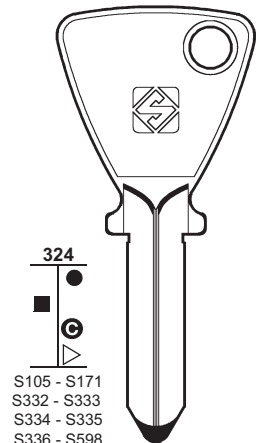

S105 - S171
S332 - S333
S334 - S335
S336 - S598
S599 - S600
S601 - S678
S259 - S807

KE1



JPM

PER: **KESO**
FOR:

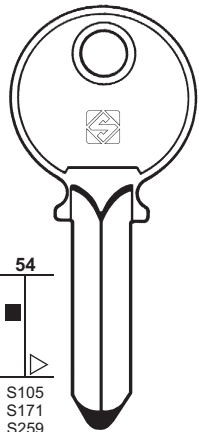

54

- S105
- S171
- S259
- S332
- S333
- S334
- S335
- S336
- S598
- S599
- S600
- S601

KE2



JPM

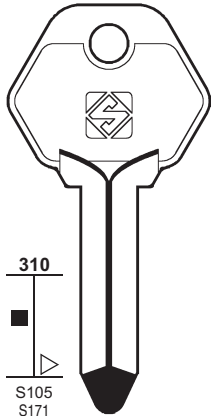

310

- S105
- S171
- S259
- S332
- S333
- S334
- S335
- S336
- S598
- S599
- S600
- S601

KE4



SARGENT

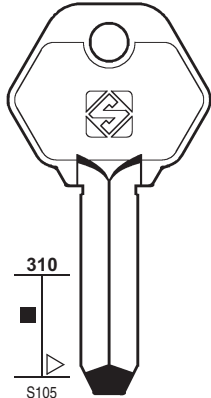

310

- S105

LP11



LIPS

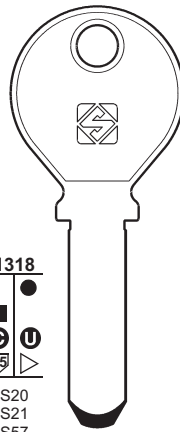

1318

- S20
- S21
- S27
- S57
- S267
- S273
- S277
- S359
- S1298

KE3



ALA

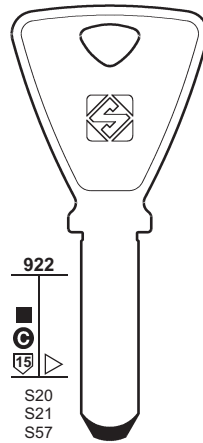

922

- S20
- S21
- S57
- S267
- S273
- S277
- S359
- S663
- S1298

KE9



JPM



105

PER: **KESO** **KEYA** **KFV**
FOR:

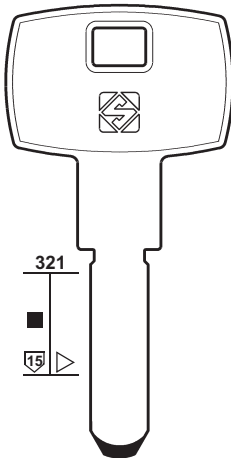

321

- 15

KE11



JPM

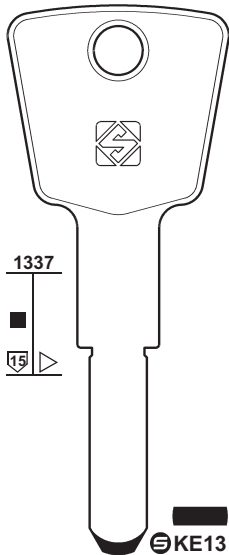

1337

- 15

KE13



FIAM

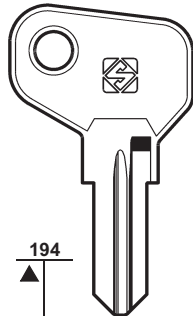

194

- 5

KEY1

KEY1R

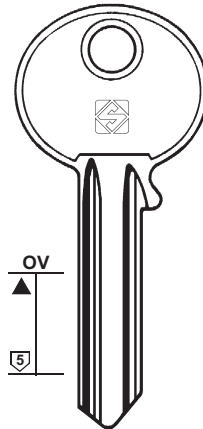

OV

- 5

COMBA - FCV - FLIETHER

GIESCHE - GÖTZ - GRAF - HSA
NICO - SCHÜCO - SEN

- KFA
- KFB
- KFC
- KFD
- KFE
- KFF
- KFG
- KFH
- KFS
- KFR
- KFJ
- KFK
- KFL
- KFM
- KFN
- KFO
- KFI
- KFU
- KFX
- KFW

PER: **KHARKOV**
FOR:

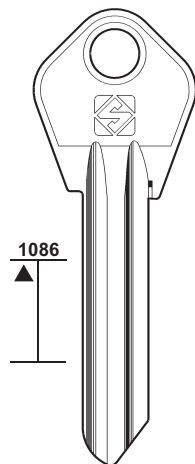

1086

HAK1

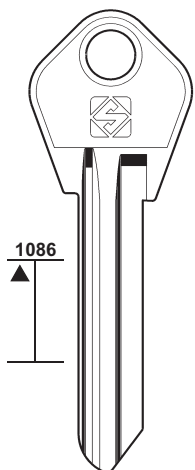

1086

HAK2

HAK6

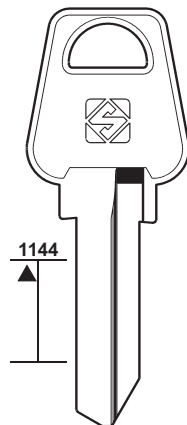

1144

HAK3

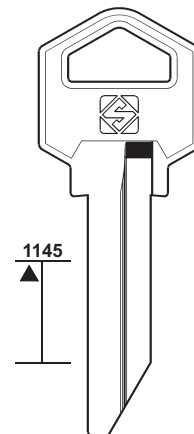

1145

HAK4

PER / FOR
KESO (CH)
ALA
FIAM
JPM
LIPS
SARGENT

KEYA (E)
+ MELSMETALL (122)

KFV (D)
COMBA
FCV
FLIETHER
GIESCHE
GÖTZ
GRAF
HSA
NICO
SCHÜCO
SEN

KHARKOV (UA)



106

PER / FOR

KIENZLE (D)
VDO

KIEV (UA)
METIZ

KIFERM (F)

ATAL
CASH-BOX
DEF
GB
HÄFELE
IJN
JU
LAS
METEOR
ORDO
RENZ
SEIM
TEEN HAAF
WESCO
+ LAS (110)
+ RICOUARD (146)

KILT (F)

VACHETTE (180)

KIMA (D)

CES (42)

KIND (D)

CES (41-42)
HOPPE (93)

PER:
FOR:

KIENZLE

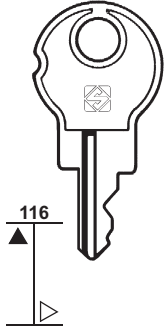

KZ1

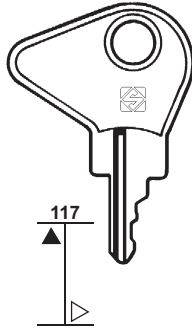

KZ2
1

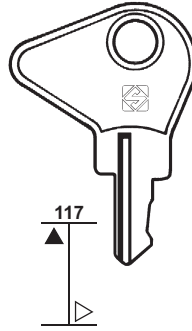

KZ3
2

VDO

KIEV

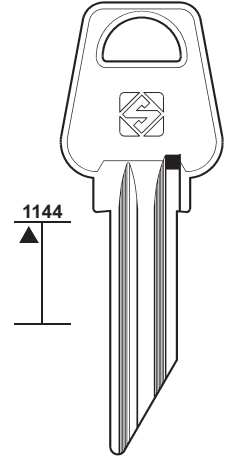

MTZ1

METIZ

PER:
FOR:

KIFERM

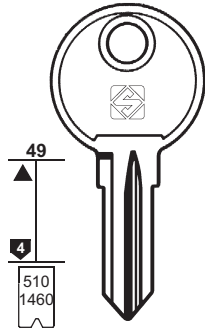

KI4
... 1-50
... 167
X ... 167

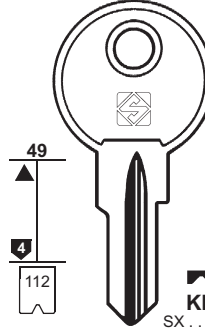

KI6
TX ... 1-275

KI5R
SX ... 1-275
XT ... 1-75
RX ... 1-275

KI5
C ... 1-275
XS ... 1-275

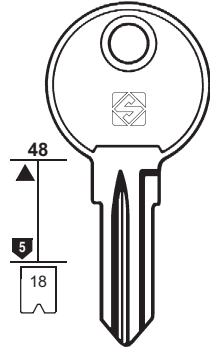

KI8
W ... 1-224

KI8R
Z ... 1-224

KI12
... 151-218
... 101-150
... 1116-7776
H ... 1116-7776
E ... 425-499

KI12R
... 1-68
... 51-100
H ... 500-574
E ... 1116-7776

KI7
XY ... 1-275

KI7R

ATAL - IJN - JU
LAS - METEOR
RENZ - TEEN HAAF

KI10
Y ... 1-224

KI10R
C ... 1-224
CA ... 1-224

DEF - GB
LAS - ORDO

PER:
FOR:

KIFERM

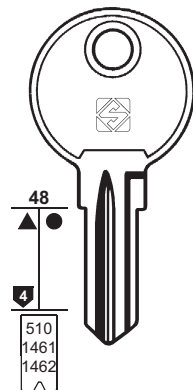

KI9
... 226-293
... 1-2-3
F ... 80-130
... 258

KI9R
... 76-143
CASH-BOX

DEF - HÄFELE
LAS - WESCO

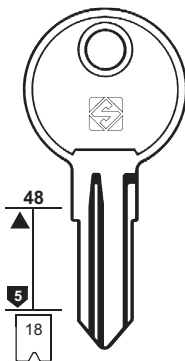

KI13
P ... 1-224

LAS

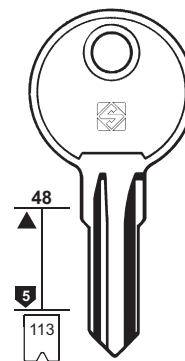

KI16
EX ... 1-224

LAS

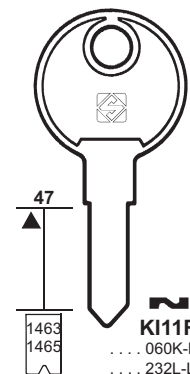

KI14
TL ... 1-50

KI11R
... 060K-K660
... 232L-L332

KI11
... 232K-K332

KI15
S ... 1-20

KI15R
T ... 1-20

SEIM

PER: FOR:	KING	KIROVSMACH	KISHINEV	

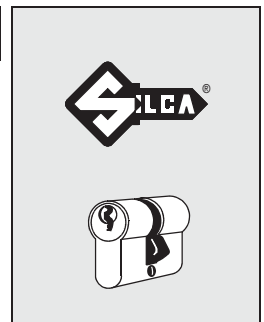

107

PER / FOR
KING (RC)
KIROVSMACH (RUS)
KISHINEV (MD)
KITTY (RC) ABLOY (4)
K+K (I) TAMPALINI (164)
KKL (A) WB
KMF (GR)
KNAPP (D) CES (41-42)
KNAUS (GB) EURO LOCKS (71)
KOBE (RUS)
KOPAT (YU)
KÖNIG (D) VIRO (186)
KOVER (D) EMKA (69)
KP (RUS)
KRAMATORSK (UA)
KREMENCHUK (UA)
KROST (D) BUS (39)
KUNERT (D) CISA (50)
KURZEMES (LV) AISPUTE (12)

PER: FOR:	KKL	KMF	KOBE	KOPAT

PER: FOR:	KP	KRAMATORSK	KREMENCHUK



108

PER / FOR

KVR (D)
CAP
PROTEC

KWIKSET (USA)
BRICARD
E-Z-SET
MASTER
VACHETTE

KYNNARPS (GB)

KYR (I)
SECURITAL (153)

LABOFA (NL)
GEGE (85)

LADA (RUS)

LA FONTE (BR)

PER: FOR: KVR

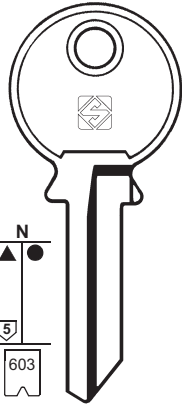

N
▲ ●
5

603

... 1576-1725



CA9

CAP - PROTEC

KWIKSET

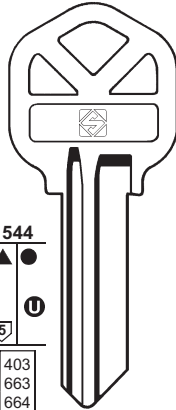

544
▲ ●

U

5
403
663
664



KS1

0-1-2-3-4-5-6-7
1-2-3-4-5-6-7
1-2-3-4-5-6-7-8-9

BRICARD - E-Z-SET - MASTER - VACHETTE

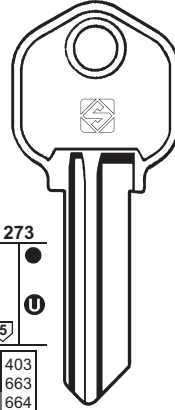

273
▲ ●

U

5
403
663
664



KS1FT

0-1-2-3-4-5-6-7
1-2-3-4-5-6-7
1-2-3-4-5-6-7-8-9

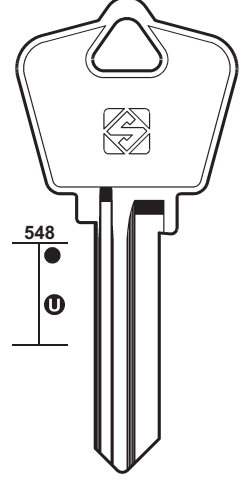

548
▲ ●

U



KS4

PER: FOR: KYNNARPS

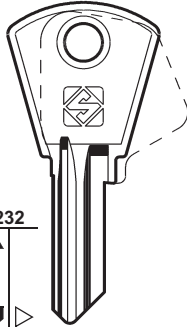

232
▲

5

474

... 201-250



KNA1

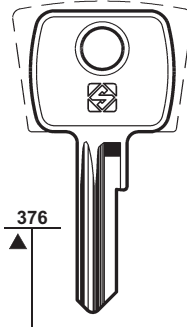

376
▲



KNA2

LADA

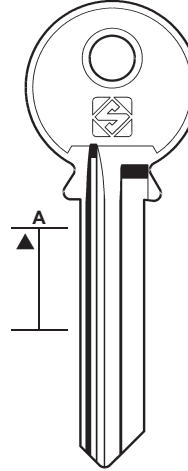

A
▲



LD4

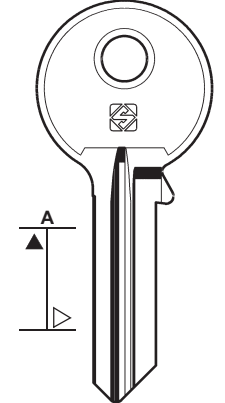

A
▲



LD4R



LD5R

PER: FOR: LA FONTE

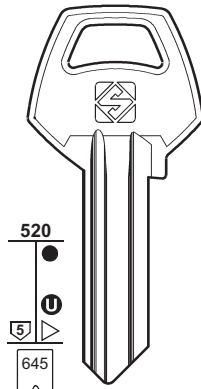

520
▲ ●

5

645

... 1-2-3-4-5-6



LAF1

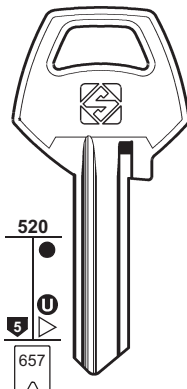

520
▲ ●

5

657

... 1-2-3-4-5



LAF2

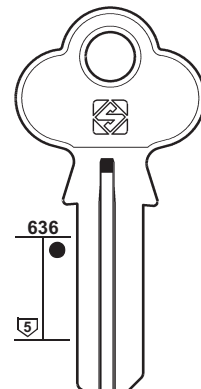

636
▲ ●

5



LAF4R

PER:
FOR:

LA FONTE

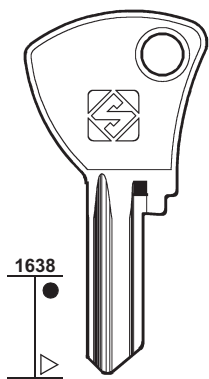

LAF5

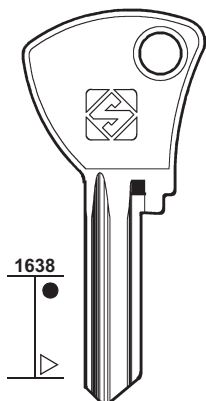

LAF6

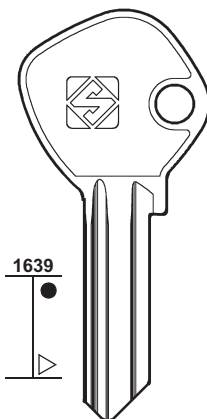

LAF7

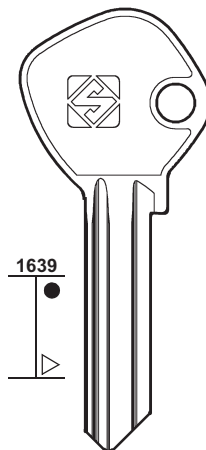

LAF8



109

PER / FOR

LA FONTE (BR)

LAGRANGE (USA)
ILLINOIS (96)

LAMA (YU)
+ MERONI (123)
+ TITAN (167)

LAMPA (USA)
CEMA (41)

LANE (AUS)
CORBIN (54)

LAPERCHE (F)
+ CAS-CISMA (40)
+ DOM (63)
+ RONIS (146-147)

PER:
FOR:

LAMA

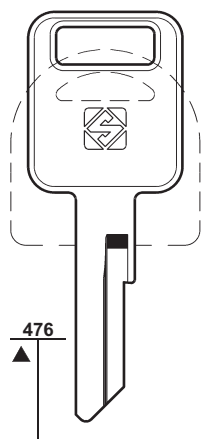

LMA1



LAPERCHE

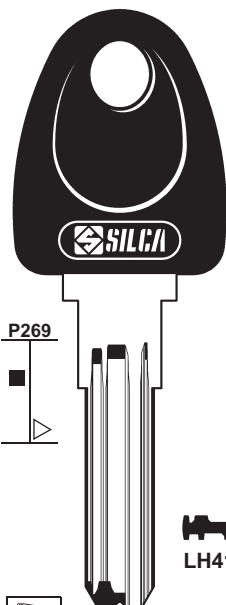

LH41P

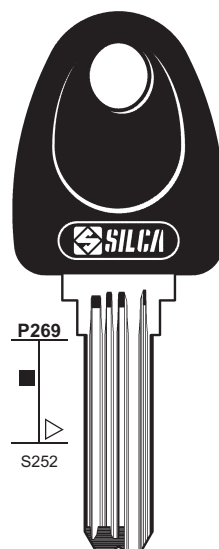

PER:
FOR:

LAPERCHE

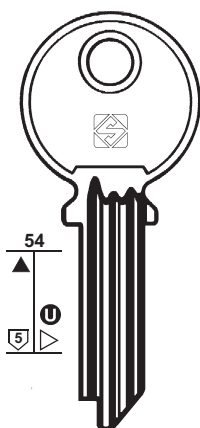

LH1
DM

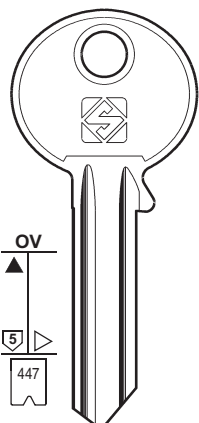

LH4

- C0 1-1000
- C1 1-1000
- C2 1-1000
- C3 1-1000
- B0 1-1000
- B1 1-1000
- B2 1-1000
- B3 1-1000

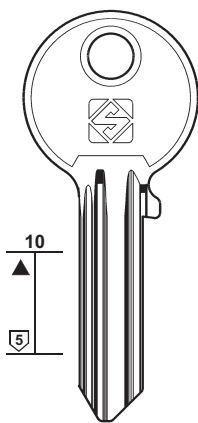

LH40

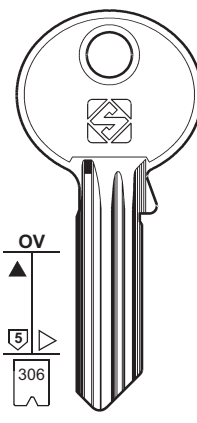

LH42

- L0 1-9999



110

PER / FOR

LAPERCHE (F)

- + CAS-CISMA (40)
- + DOM (63)
- + RONIS (146-147)

LA PORTE (D)

- DLP
- GHE
- PRESTA
- + BOMORO (33)
- + DLP (59)

LAREDO (E)

- YALE (193)

LARK (RC)

- GLOBE (87)

LAS (F)

- ATAL
- DUBOIS
- HÄFELE
- KIFERM
- MARCADET
- PK
- RENZ
- RONIS
- STRAFOR
- WESCO
- + KIFERM (106)
- + RICOUARD (146)

PER:
FOR:

LAPERCHE

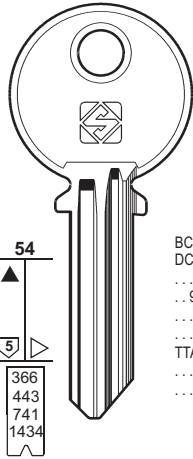

LH5
..... 0-1-2-3-4-5-6-7-8-9
..... 1-2-3-4-5-6-7-8-9
TTP 0-1-2-3-4-5-6-7-8-9
... 9 ... 1-2-3-4-5-6-7-8-9

LH5R

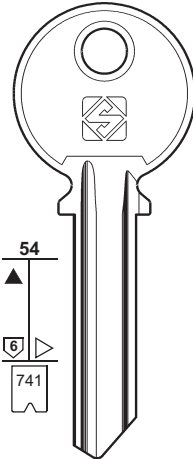

LH10
..... 0123456789
UUP
0123456789

LH10R

LH20
..... 0-1-2-3-4-5-6-7-8-9
TTR
0-1-2-3-4-5-6-7-8-9

LH21
..... 0-1-2-3-4-5-6-7-8-9
TTS
0-1-2-3-4-5-6-7-8-9

LH22
..... 0-1-2-3-4-5-6-7-8-9
TTT
0-1-2-3-4-5-6-7-8-9

LH23
..... 0-1-2-3-4-5-6-7-8-9

LH24
..... 0-1-2-3-4-5-6-7-8-9

LH25
UUR
0-1-2-3-4-5-6-7-8-9

LH26
UUS
0-1-2-3-4-5-6-7-8-9

LH27
UUT
0-1-2-3-4-5-6-7-8-9

LH28
UUV
0-1-2-3-4-5-6-7-8-9

LH29
UUX
0-1-2-3-4-5-6-7-8-9

PER:
FOR:

LA PORTE

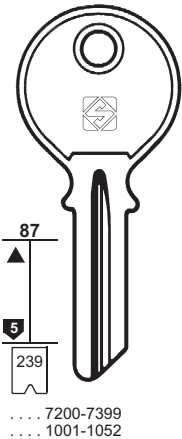

LAP1

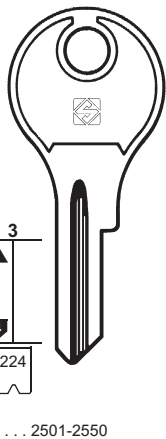

DL1R

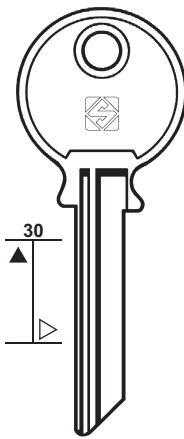

LAP3

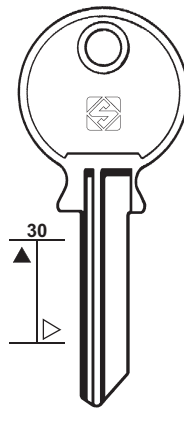

LAP2

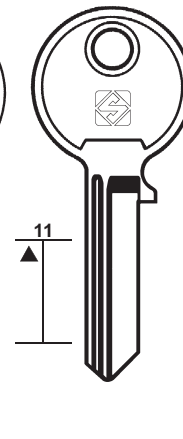

DL3

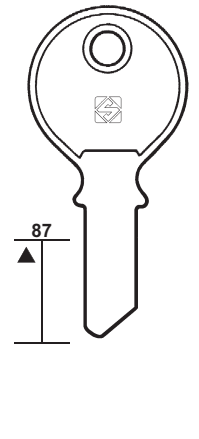

DL2

GHE - PRESTA

DLP

PER:
FOR:

LAS

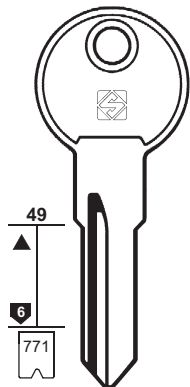

LS3
A ... 1-650

LS10
AB

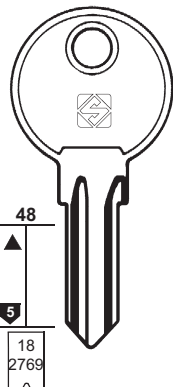

LS1
R ... 1-224

DUBOIS - KIFERM
PK - RENZ
RONIS - WESCO

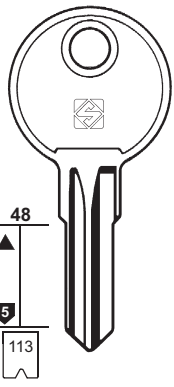

LS1R
V ... 1-224

ATAL - HÄFELE
KIFERM

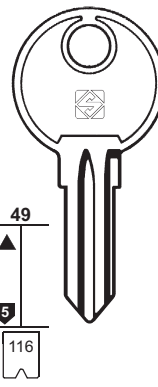

LS2
AX ... 1-224

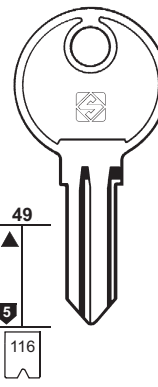

LS7
FH ... 1-400
LH ... 1-400
FH ... 501-550

LS4
U

LS4R
X

LS19
FH ... 1-400
LH ... 1-400
FH ... 501-550

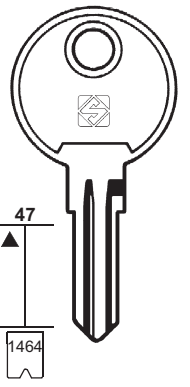

LS12
LS ... 1-60

PER: **LAS**
FOR:

LS5
L

LS6
L231

LS9
AT ... 1-650

LS9R
TA ... 1-650

LS11
RM ... 1-2000
KT ... 3001-4000
KT ... 7001-8000

LS11R
TK ... 4001-5000

LS13
JH ... 1-100
FH ... 1-400
LH ... 1-400
SH ... 1-400
WH ... 1-400
AA ... 1-50
LH ... 1-60
... 301-675
FH ... 501-500

LS14
MJ ... 1-400
FM ... 1-100
SM ... 1-400
MR ... 001-050
FM ... 501-550
SM ... 501-550

LS14R

LS15

LS17
PR

LS18
PM ... 1-10

FORT

LS13R
FM
SH ...
501-550

MARCADET - RONIS

ABBES - ORDO



111

PER / FOR

LAS (F)
ABBES
FORT
MARCADET
ORDO
RONIS
+ KIFERM (106)
+ RICOUARD (146)

PER: **LÅSBOLAGET**
FOR:

LEGALLAIS

LB11

LB10

LB19

LB18

LB23

LB22

LB28
6543210

LB29

LB32

LB33

LB34

LB35

TANLOCKS

TANLOCKS

LEA1

HB

LÅSBOLAGET (S)
TANLOCKS
+ KABA (102)
+ SIS (156)

LAUDON (RSA)
L & F (117)

LBLM (E)
FORTIS (81)

LE FEBURE (USA)
CIFIAL (47)

LEGALLAIS (F)
HB

LEGGE (GB)

LEHEMANN (D)
MLM (127)

LEN-LOK (AUS)
ROLL-A-DOOR
+ LOCKWOOD (115)

LG (F)
ARROW (18)

PER: **LEGALLAIS**
FOR:

LEGGE

LEN-LOK

LEA2

LEG1

LEG2

LEG3
PASSEPARTOUT

LL1
LL

ROLL-A-DOOR



112

PER / FOR

LINCE (E)
ICSA
+ ALPHA (15)

LION (USA)
JUNKUNC (101)

LIONA-LIOX (F)
RONIS (146)

LIPS (NL)
DALWA (57)

PER:
FOR:

LINCE

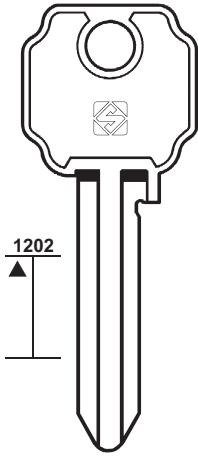

LC10
K

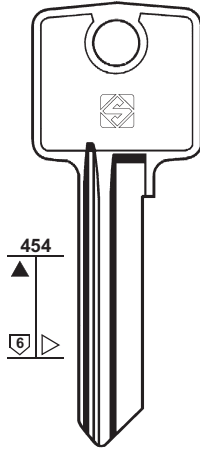

LC7 **LC7R**
M M

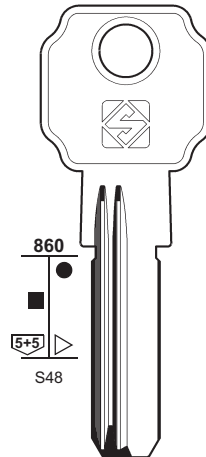

LC14R
X
ICSA

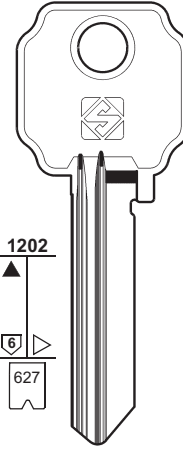

LC15 **LC15R**
S S
1-2-3-4-5-6-7-8

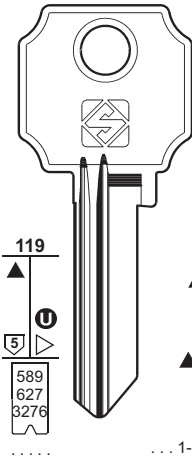

... 1-160 **LC11**
R
1-2-3-4-5-6-7-8

- LC1**
A
- LC1R**
A
- LC2**
C
- LC2R**
C
- LC11**
R
- LC11R**
R
- LC12**
B

PER:
FOR:

LINCE

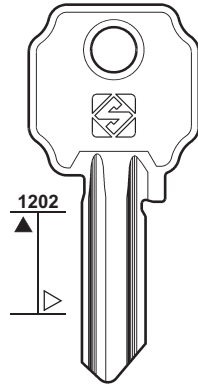

LC13
U

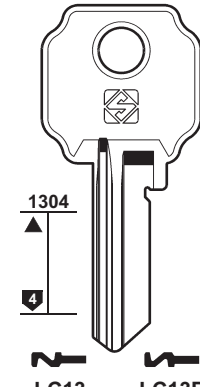

LC13 **LC13R**
D1 D1

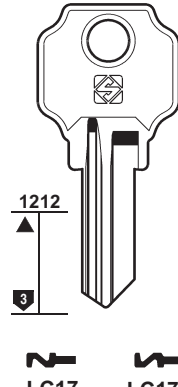

LC17 **LC17R**

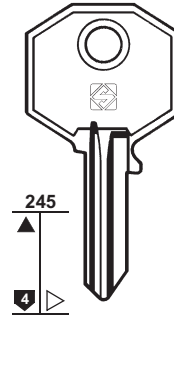

LC9R

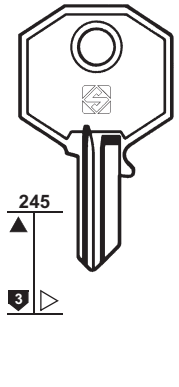

LC6 **LC6R**
J J

LC5 **LC5R**
F F

PER:
FOR:

LIPS

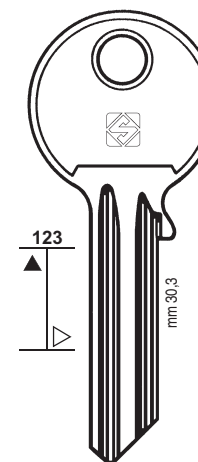

LP38R
34D

LP36R
34B

LP35R
34A

LP12 **LP12R**
22 25

LP8 **LP8R** ▲ ●
39 41

▲ ● **LP2** **LP2R**
29 34

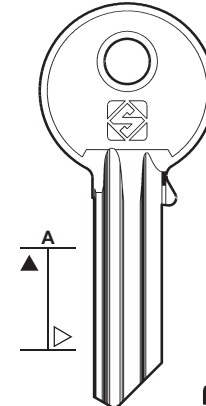

LP20R
35C

LP13 **LP13R**
23 26

LP7 **LP7R**
40 42

Ⓢ ● **LP5** **LP5R**
30 35

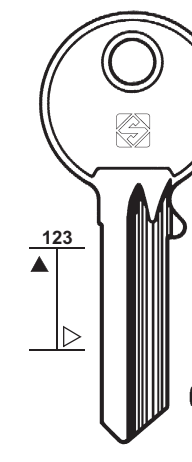

LP17R
A

LP18R
B

LP19R
D

PER:
FOR:

LIPS

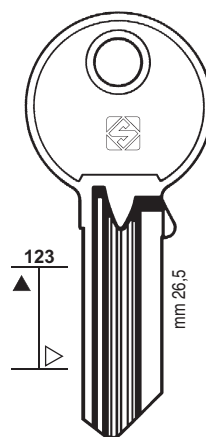
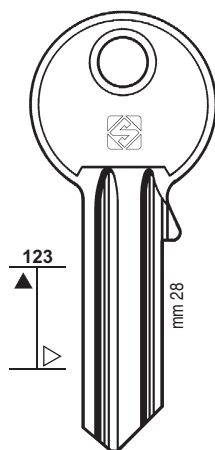
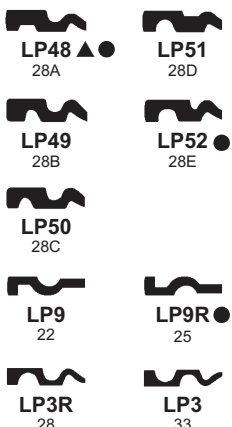
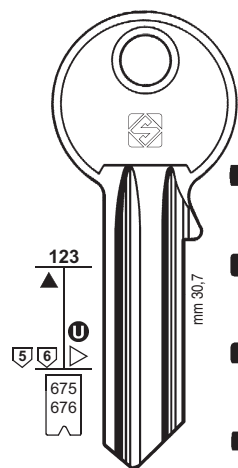

.....
1-2-3-4-5-6-7-8-9-0
A-B-C-D-E-F-G-H-I-L



113

PER / FOR

LIPS (NL)
+ DALWA (57)

LIPS-VAGO (I)
 PREFER (143)

LISTA (D)
 DOM (62)

LITTO (B)
ANKERSLOT
BKS
CORBIN
+ ANKERSLOT (16)
+ CORBIN (53)

PER:
FOR:

LIPS

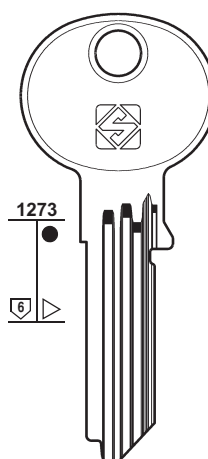
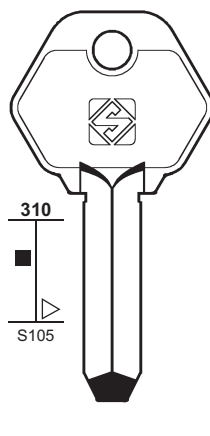
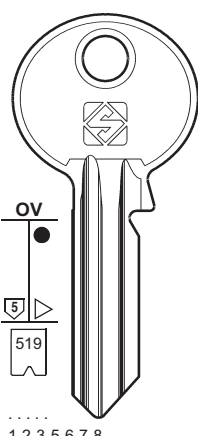
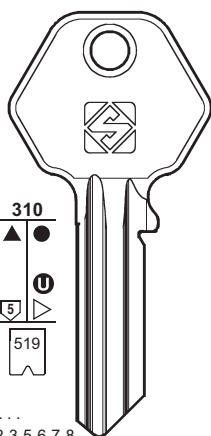

.....
1-2-3-5-6-7-8

.....
1-2-3-5-6-7-8



PER:
FOR:

LIPS

LITTO

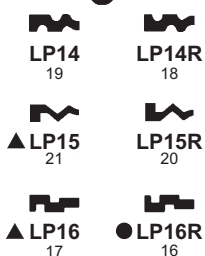
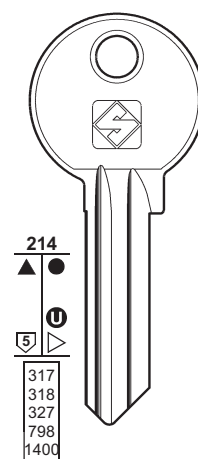
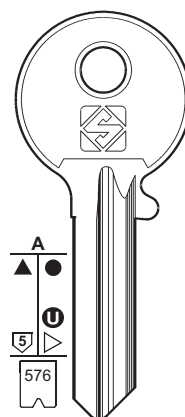
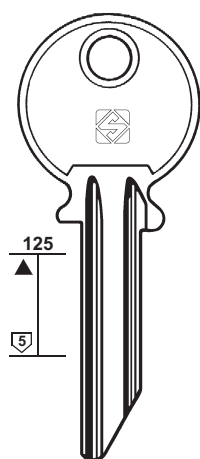
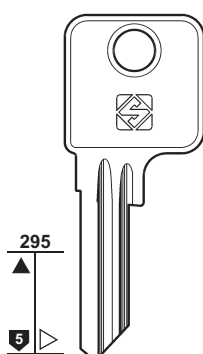
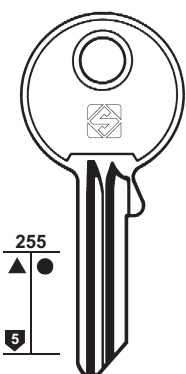

BKS

ANKERSLOT

CORBIN



114

PER / FOR**LITTO (B)**

+ ANKERSLOT (16)

+ CORBIN (53)

LM (S)

+ TEKA (165)

L.M.C. (D)

+ HUWIL (94)

LML (I)

+ MORI E. (128)

LN (BR)**LOB (PL)**

+ BRICARD

+ EXPRES

+ REDY

+ ROSTEX

+ YETI

+ FAB (74)

+ MCM (121)

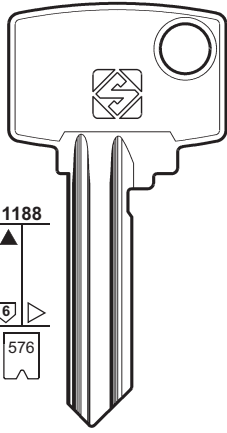
LOCKSYS (BG)**LOCKWELL (BR)****PER:
FOR:****LITTO****LN**

..... 1234567890

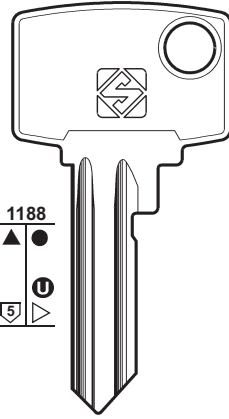
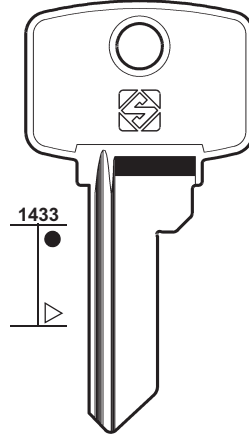
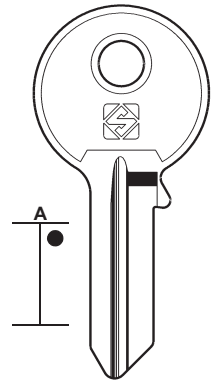
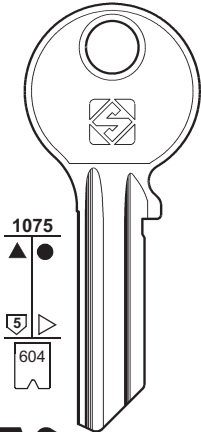
LT3**LT4****LT5****LN1****PER:
FOR:****LOB****YT16****YT15**

..... 0-1-2-3-4-5-6-7-8-9

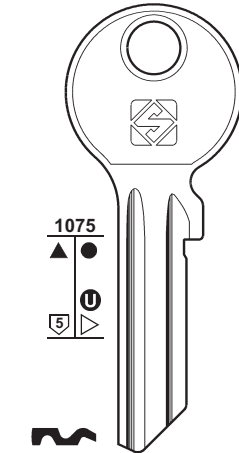
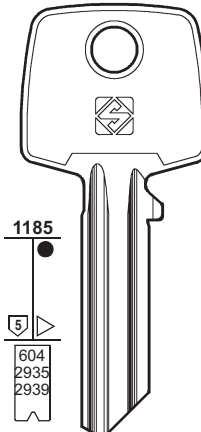
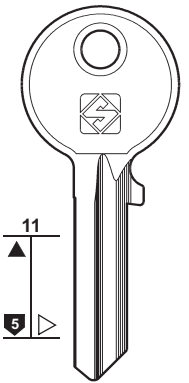
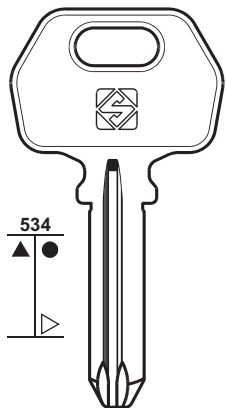
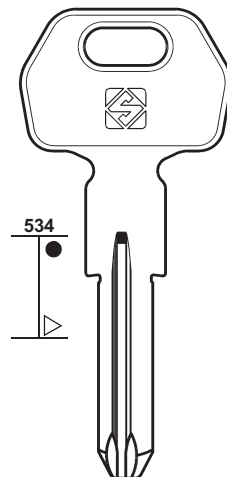
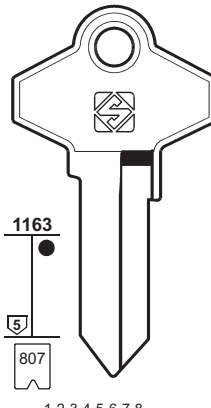
**BRICARD - EXPRES
REDY - YETI****YT16X****YT15X****YT15RX****YETI**..... 0123456789
..... 123456789ABC**LOB16****YETI****LOB1** **LOB1R****ROSTEX****PER:
FOR:****LOCKSYS****LOCKWELL****LCK1R****LCK1RX****LOC1**

..... 1-2-3-4-5-6-7-8

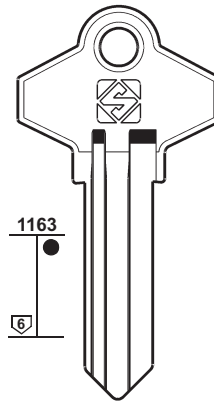
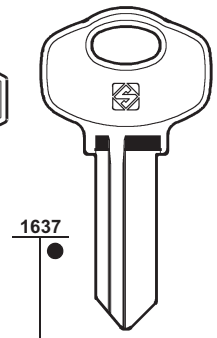
**LOC3****LOC4**

PER:
FOR:

LOCKWOOD

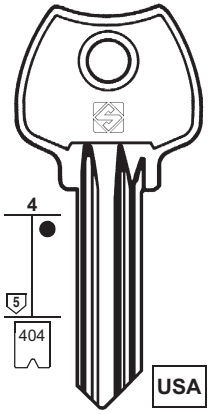

LW1 ▲ LW1R
.....
0-1-2-3-4-5-6-7-8-9

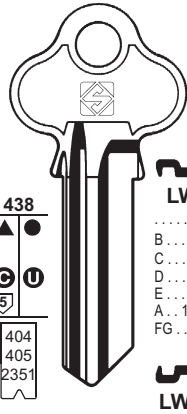

▲ LW20
..... 0123456789
X..... 100-27787
HX..... 1000-1500

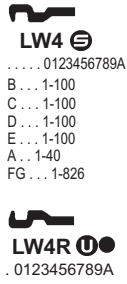

▲ LW20R
..... 0123456789

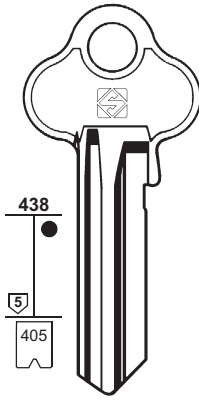

LW40 ▲ LW40R
.....
0-1-2-3-4-5-6-7-8-9-A

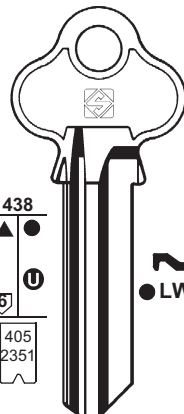

LW5 ● LW5R ●
..... 0123456789A
B... 1-100
D... 1-100
F... 1-100
A... 1-40
C... 1-40

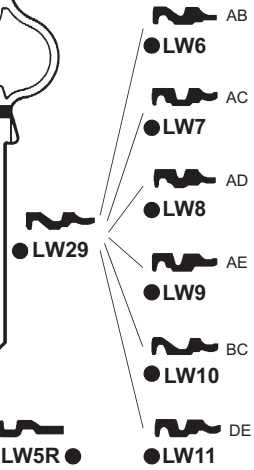

- AB
- LW6
- AC
- AD
- LW8
- AE
- LW9
- BC
- LW10
- DE
- LW11

GAINSBOROUGH



115

PER / FOR

LOCKWOOD (AUS)
GAINSBOROUGH

LOCKWOOD (AUS) (USA)
LEN-LOK

PER:
FOR:

LOCKWOOD

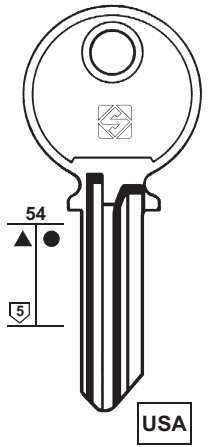

LW2 ● LW2R

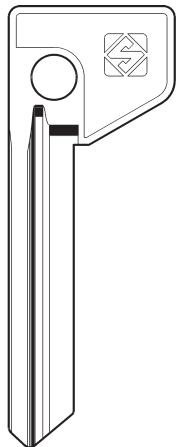

LW21R
.....
0-1-2-3-4-5-6-7-8-9-A

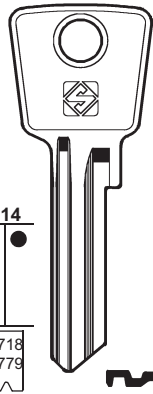

LW28
..... 1-3720
..... 3001-6720
..... 456789A

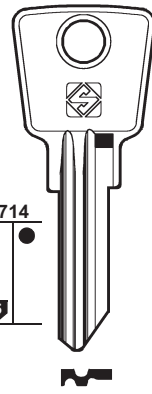

LW14
24A

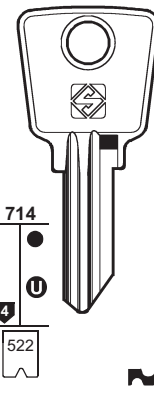

LW3
..... 1-960
L... 1-960
L... 151-250

● LW13 ● LW12R
CL... 1-1000 Y... 1-960



PER:
FOR:

LOCKWOOD

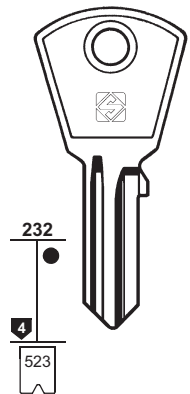

LW15
..... 1-2100

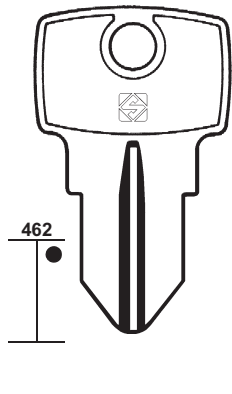

LL1
LL

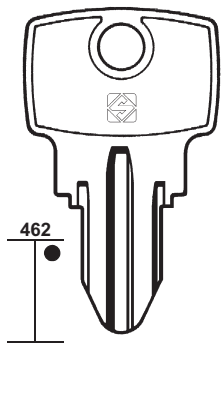

LW16
R

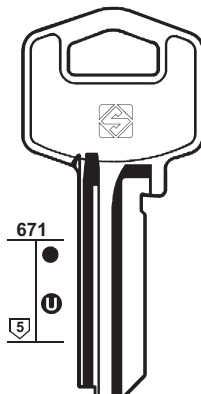

LW17
N

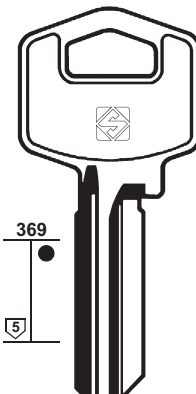

LW18

LW19



LEN-LOK



116

PER / FOR

LOCKWOOD (AUS) (USA)

LOGO (I)

CISA (48-50)

LOK 2000 (I)

CISA (50)

LORI (USA)

EAGLE (67)

LOTUS (RC)

YETI (198-199)

L & F (GB)

ATAL
DAD
DOUBLE SAFE
EURO LOCKS
IBFM
MIBRA
TELFORD
ULTRA
UTZ

+ CHICAGO (46)

+ EURO LOCKS (71)

PER: LOCKWOOD
FOR:

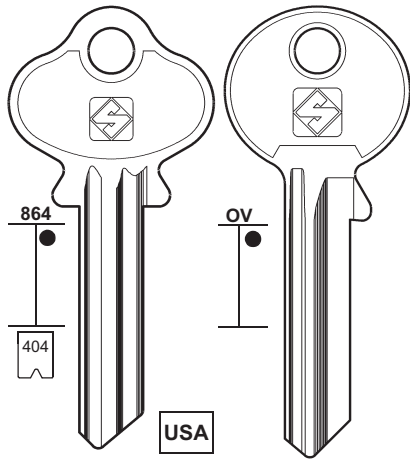

LW23
..... 0123456789



LW24



LOWE & FLETCHER

LF2
G ... 1001-5000
..... 31001-32000
..... 31001-33000
..... 32001-33000
..... 36001-38000
..... 38001-38999
..... 77001-77500
..... 87001-91000
..... 95000-99000
..... 5001-9000

LF13
..... 2001-4000

LF17
ATAL

LF23R
EL ... 1-500
..... 1001-1100
93 ... 401-900
..... 9001-9500
EL ... 9001-9500

LF22R
mm 19

LF22
93 ... 201-400
..... 93901-94000

LF26
..... 77001-77500
..... 95000-99000

LF16 **LF16R** **LF15R**
..... 90901-90975

LF57

DOUBLE SAFE
EURO LOCKS

DAD - MIBRA - UTZ

PER: LOWE & FLETCHER
FOR:

LF20 **LF20R**
..... 93901-94000

LF4
60 ... 1-400
90 ... 1-200
92 ... 1-400
..... 1-400
GHM ... 1-155
M ... 1-400
92 ... 401-600
99 ... 1-400
RV ... 1-400
RVM ... 1-400
SP ... 1-400
GS ... 1-400
... ES1
... EV1

LF4R
99 ... 401-600
92 ... 501-700

LF6 **LF6R**
90 ... 1-200
..... 1-400
91 ... 201-350
GH ... 1-400
SS ... 1-400
92 ... 401-600
GS ... 1-400

LF11 **LF11R**
76 ...
1-400
.....
70001-71200

LF7

LF18R **LF42R**
FFE ... 1-100
NF ... 1-30

LF52 **LF8** **LF8R**

ULTRA TELFORD

PER: LOWE & FLETCHER
FOR:

LF29R

LF24 **LF25**
V ... 1-88
E ... 101-600
RE ... 101-600
..... 5001-9000
..... 31001-33000
..... 36001-38000
..... 87001-91000

LF27 **LF27R**
..... 419001-419420
19 ... 1-420
..... 17001-19000
..... 23001-23400
..... 23001-25100
..... 27001-27400
..... 7001-7400
..... 7001-9000
..... 701-900
..... 1-150

LF43R
92 ... 601-800

LF37
R ... 151-650
T ... 1-1000
S ... 1-1000
..... 9001-9494

AUSTRALIA AUSTRALIA

PER:
FOR:

LOWE & FLETCHER

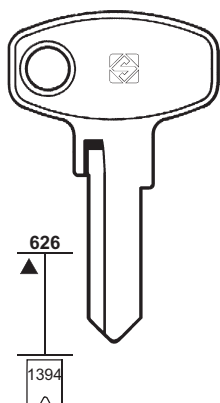

LF28R
RO2...
101-215

EURO LOCKS
LAUDON

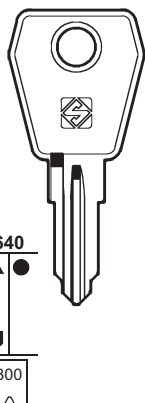

LF30R
... 801-900
... 901-1000

BASI - DAD

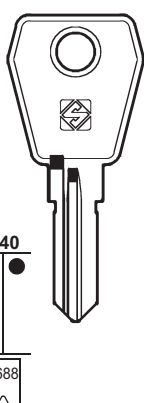

LF61R
... 6601-7100

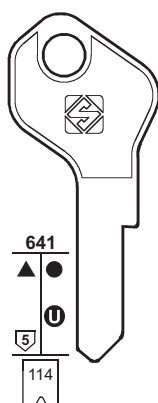

LF31R
60... 001-400
... 1-400
92... 1-400
M... 1-400
91... 201-350
... ES1
... RV1

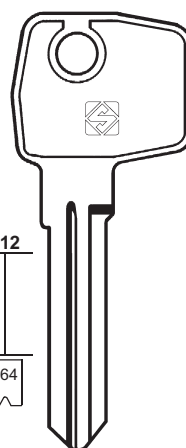

LF33
68001-70000

LF51R

EURO LOCKS



117

PER / FOR

L & F (GB)
BASI
DAD
EURO LOCKS
LAUDON
ROLL-A-DOOR
+ CHICAGO (46)
+ EURO LOCKS (71)

PER:
FOR:

LOWE & FLETCHER

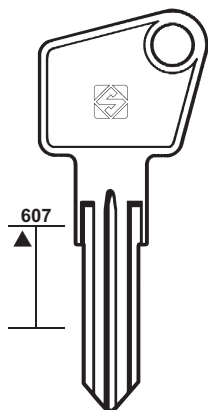

LF34

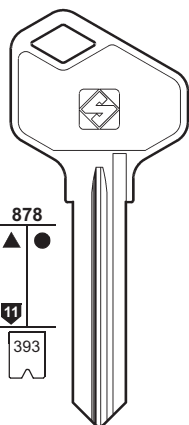

LF39
09... 1-900
29... 1-478

AUSTRALIA
ROLL-A-DOOR

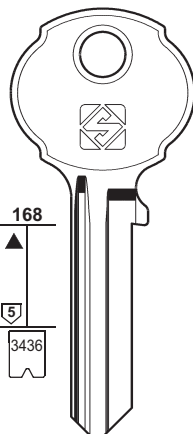

LF47
A... 12000-13049

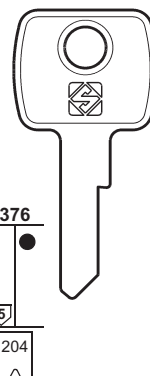

LF54
75... 001-200

PER:
FOR:

LOWE & FLETCHER

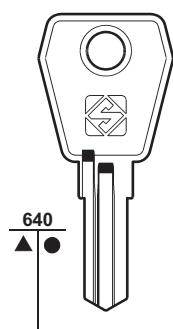

LF46R

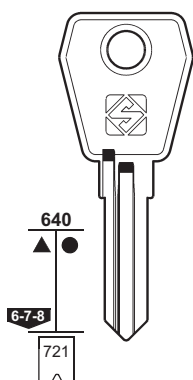

LF45R **LF53**
ME... 001-300
... 18000-18999
... 19000-19999
... 35000-35499
... 78000-78999
... 79000-79999

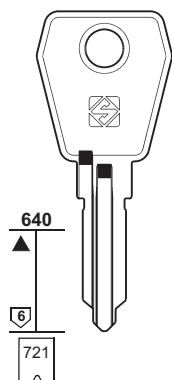

LF58R **LF59R**
AA... 000-999

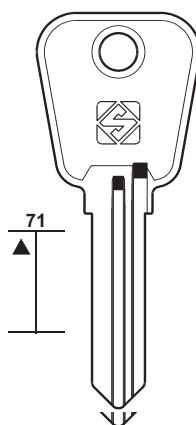

LF56

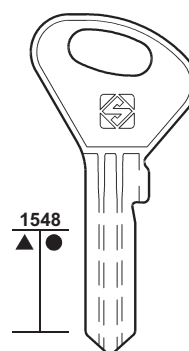

LF60



118

PER / FOR

LOXEM (GB)

LR (I)
MORI E. (128)

LUCO (RC)
GLOBE (87)

LUCKY (RC)

LUMA (E)

LUME (I)
GIUSSANI (86)

LUNA (I)
P.C.
(CORTELLEZZI) (139)

LUX (ET)

LYF (E)

M (I)
CAS-CISMA (40)

MAFOR (F)
RONIS (146)

MAQUET (F)
DOM (62)

MARCADET (F)
LAS (110-111)

MARCO (D)
DOM (62)

MAGNUM (I)

MARIANI (I)

MARK (RC)
TRI-CIRCLE (173)

MARLIN (I)
BOSS (33)

MARS (RC)

MASTER (USA)
+ ABUS (8)
+ KWIKSET (108)
+ TOK-WINKHAUS (168)

PER: **LOXEM**

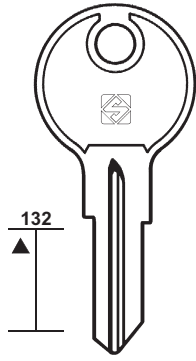

LXM1R



LUCKY

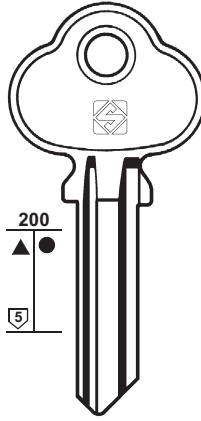

LU1

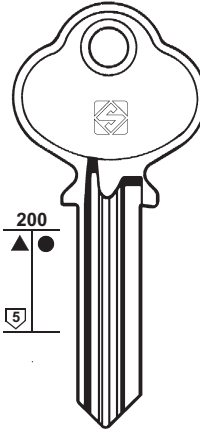

LU2

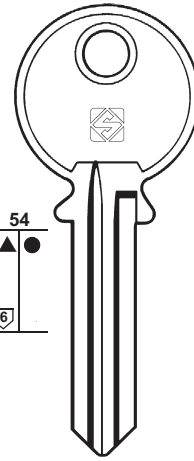

LU3R

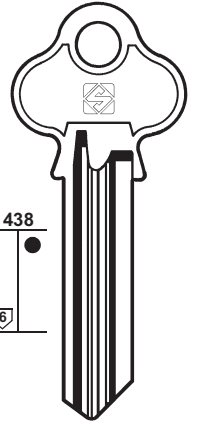

LU4

PER: **LUMA**

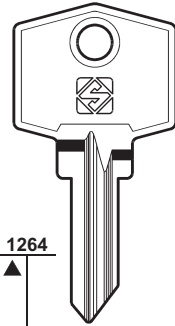

LM3

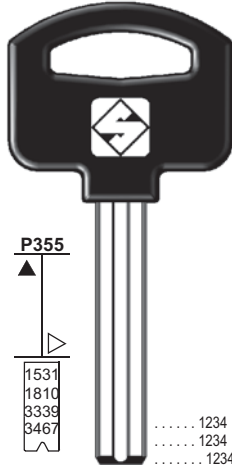

LM3R

..... 1234
..... 1234
..... 1234
..... 01234

LM4

LM4R

LM5P



LUX



LX1

LX1R



LYF

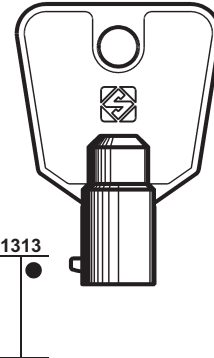

LYF1T

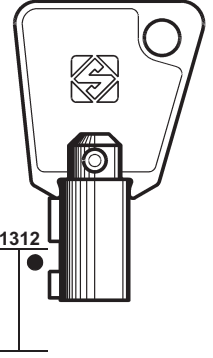
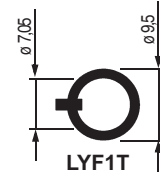

LYF2T

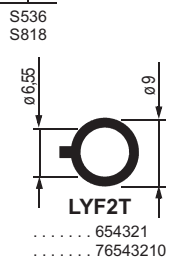

PER: **MAGNUM**

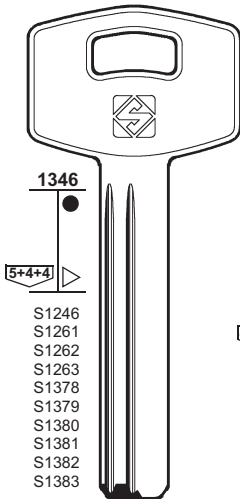

MGN1R

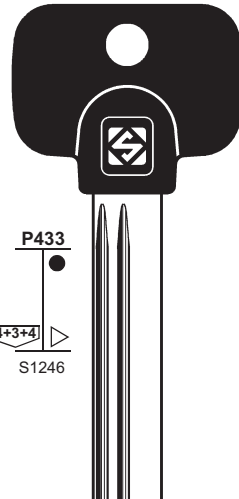

MGN1RP



MARIANI

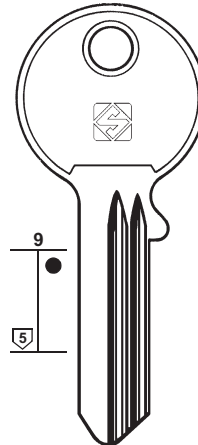

MR1

MARS

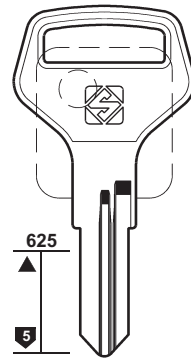

MAR1

MASTER

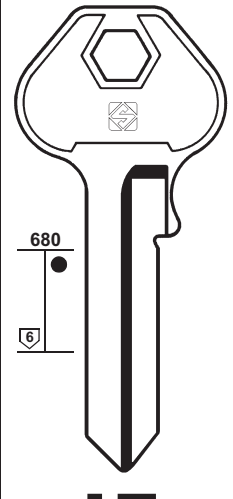

MS8



PER:
FOR: **MASTER**

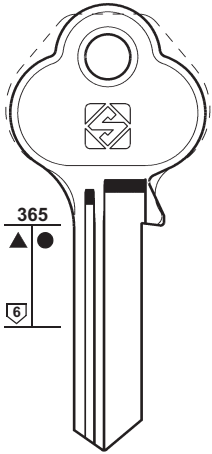

MS19

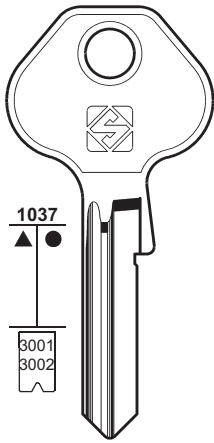

MS17
..... 01234567
410K 001-999

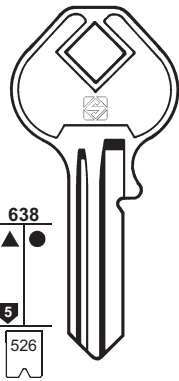

MS6 **MS5R**
10T 1-1000

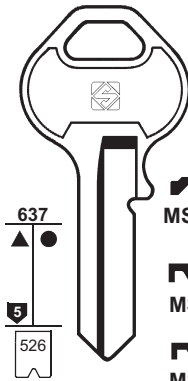

MS13R
MS9R
MS4R
..... 1-9800
34H 601-912
MS3R
10L 1-1000
MS11R

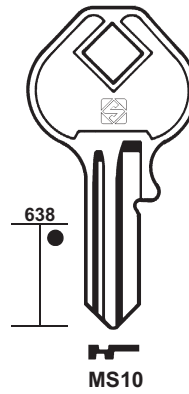

MS10



119

PER / FOR
MASTER (USA)
HAMPTON
+ ABUS (8)
+ KWIKSET (108)
+ TOK-WINKHAUS (168)

MASTER LOCK (RC)

MATTEY (F)
SUREX (163)

MAUER LOCKS (BG)
DEKABA
+ DEKABA (57)

PER:
FOR: **MASTER**

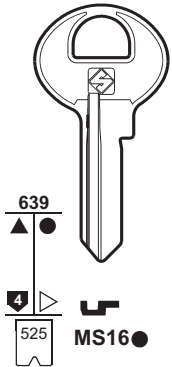

MS16

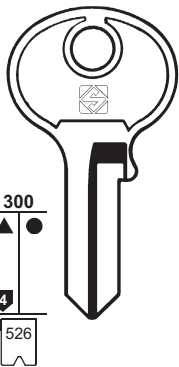

MS7



MS1



MS12

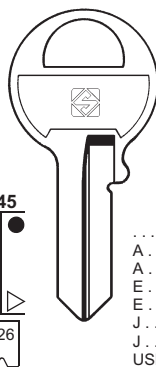

MS2

- 1-3200
- A 101-2100
- A 5501-6400
- E 1-700
- E 2001-3000
- J 301-1250
- J 2001-2150
- USN 1-4500
- W 0-3500
- WO 1-1000
- X 2001-3000
- X 5001-6000
- 4201-5000
- 5001-6000
- 6001-7000
- 7001-8000
- 8001-9000
- 9001-10000
- M 2001-4515



mm 40
HAMPTON

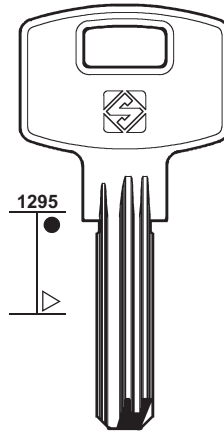

MS23

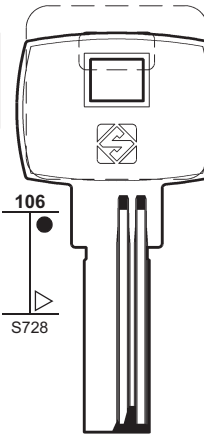

MS22



PER:
FOR: **MASTER MASTER LOCK MAUER**

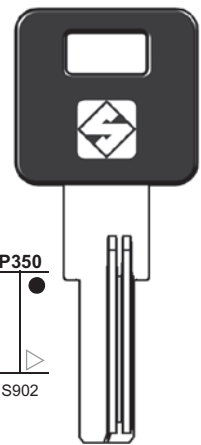

MS20P

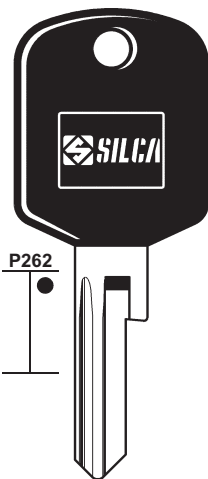

MS21AP

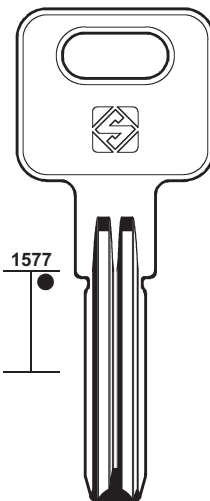

MSL1

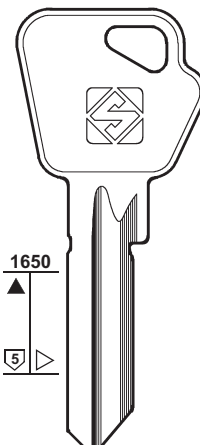

MAU1R

DEKABA

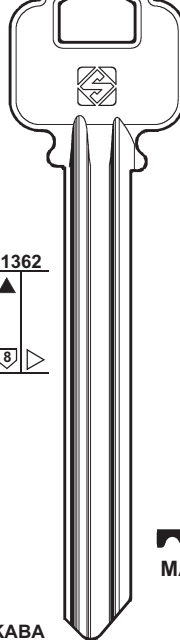

MAU2



120

PER / FOR

MAUER LOCKS (BG)
DEKABA
+ DEKABA (57)

MAUSER (D)
 CES (42)
 HOPPE (93)
 HUWIL (94)

MAXIGARD (F)
 GABON (84)

MAXUS (GB)

MAY-TAY (IL)

MBB (D)
 CES (42)

MCM (E)
MONDRAGON

PER: FOR:	MAUER	MAXUS	MAY-TAY
	 1362 1362 MAU3 MAU4 DEKABA	 1671 MXU1R	 1355 MAY1

PER: FOR:	MCM								
	 128 MC1	 129 MC1R	 129 MC2 1-2-3-4-5-6-7 0-1-2-3-4-5-6-7	 129 MC2R 1-2-3-4-5-6-7	 129 MC7	 129 MC5	 129 MC5R	 129 MC6	 129 MC6R
	MONDRAGON								

PER: FOR:	MCM					
	 129 MC4 3116	 454 MC4R 748 750 0-1-2-3-4-5-6-7	 459 MC3	 890 MC17	 890 MC8	 890 MC13
	MONDRAGON					

PER:
FOR: **MCM**

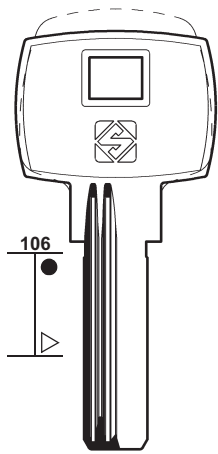

MC14R

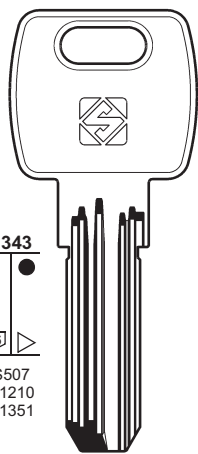

..... 162-17HH6

MC15R
E8

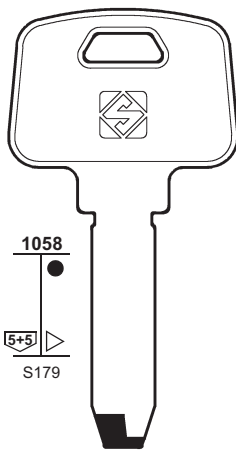

MC9X
4SS

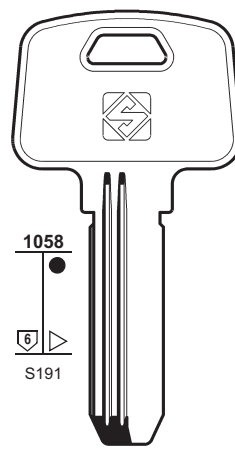

MC10R
4SE



LOB - YETI

TROMER



121

PER / FOR

MCM (E)
LOB
TROMER
YETI

MECALUX (F)
AGA (10)

MECO (D)

MEDECO (USA)

PER:
FOR: **MCM**

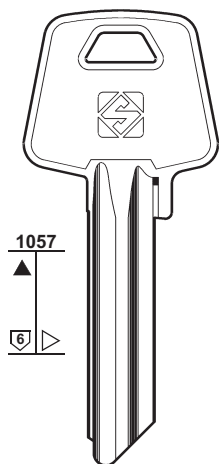

MC11
X

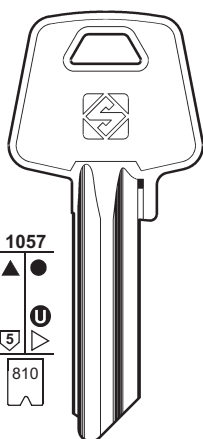

MC12
E..... 11241-79868
X..... 123456789

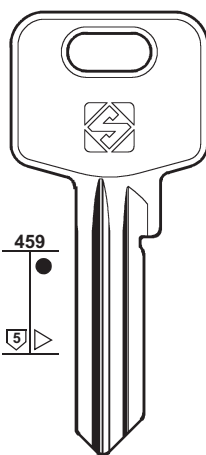

MC18R
B

MC19R
C

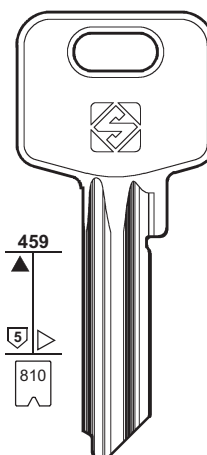

MC20
X..... 1234567890
E..... 11241-79868

PER:
FOR: **MECO**

MEDECO

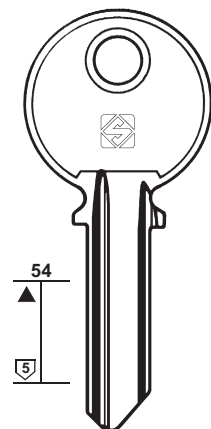

MEC1

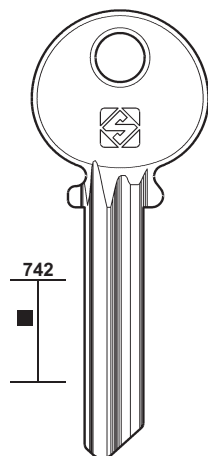

MD4

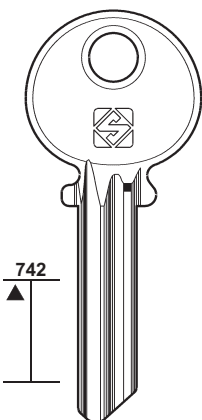

MD7

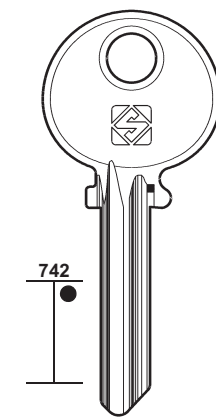

MD11

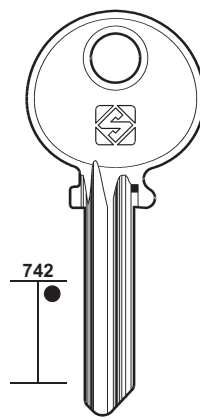

MD6

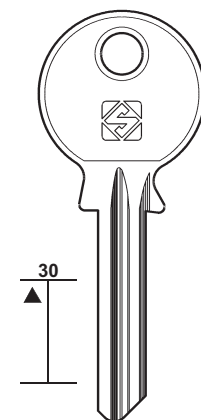

MD8R

MD1R



122

PER / FOR

ME-FA (RC)
BRABANTIA
CLAUSOR

MEGA (RO)

MELSMETALL (D)

BURG
FARCE
HBC
KEYA
SES
+ BURG (37)

MENOVA (D)

DOM (61)

MERCUR (D)

JOWIL (100)

MERLE (RA)

MERMIER (F)

CORBIN (52-53)

PER:
FOR:

ME-FA

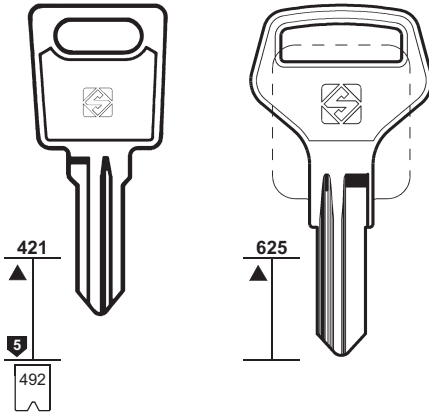

421
5
492

625

MF1R
... 1-100
... 101-200

MFA1



BRABANTIA - CLAUSOR

MEGA

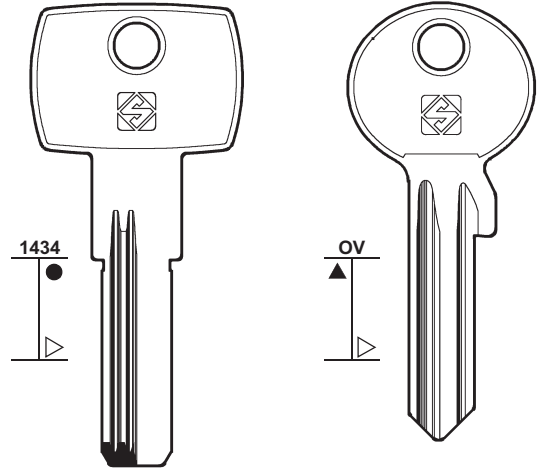

1434

OV

MEG1R



MEG2

PER:
FOR:

MELSMETALL

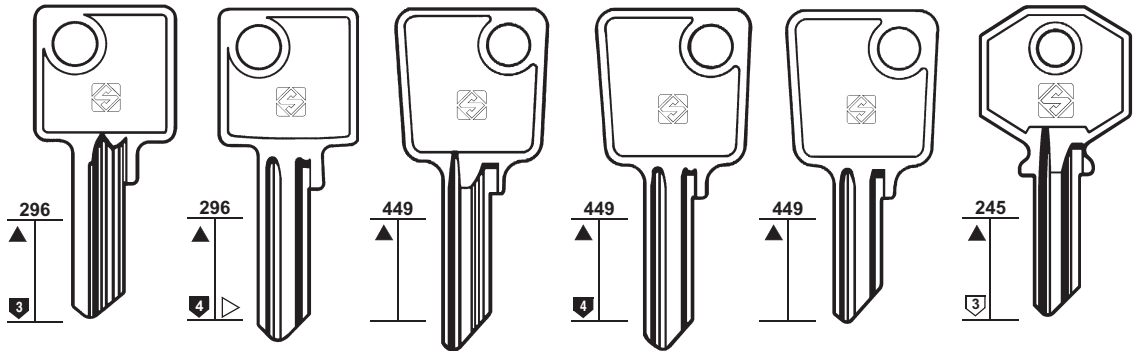

296
3

296
4

449

449
4

449

245
3

ME1

ME3

ME6

ME7

BUR6

ME2R

ME8

ME4

ME4R

ME5

ME5R



HBC



BURG

PER:
FOR:

MELSMETALL

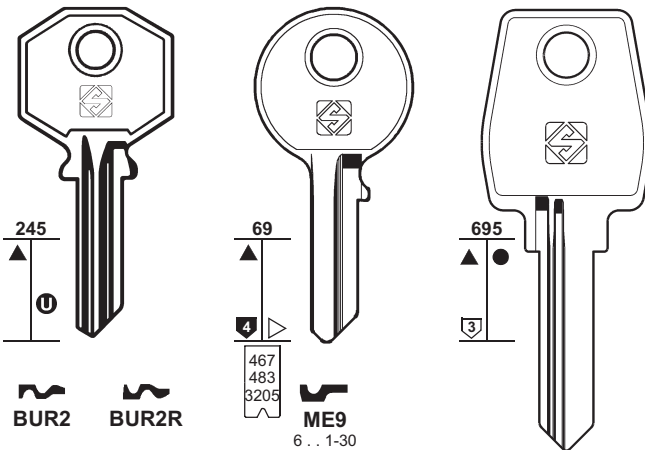

245
1

69
4

695
3

BUR2

BUR2R

467
483
3205

ME9
6 ... 1-30
6 ... 31-60
... 1234

ME10R



BURG



**FARCE - KEYA
SES**

MERLE

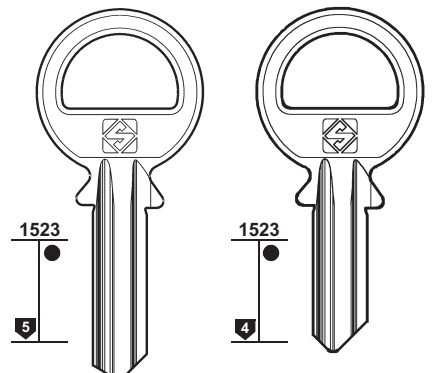

1523
5

1523
4

MLE1

MLE2

PER:
FOR:

MERONI

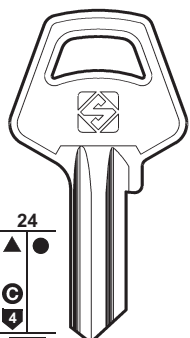

MER1

... 1001-1500

BIB - NOVOTECNICA



MER1R



LAMA

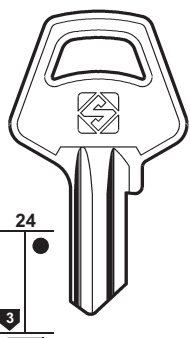

MER27

... T001-113
... 1701-1810

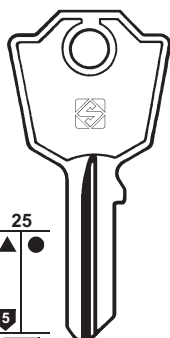

MER4

G ... 3001-3480
G ... 0-479
... 3001-3480



MER4R



LAMA

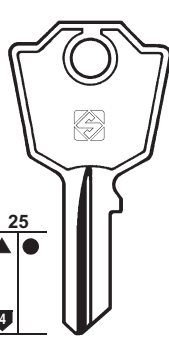

MER5

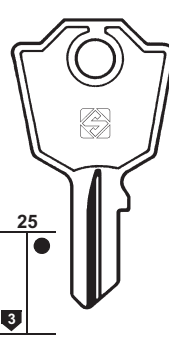

MER6



MER6R



123

PER / FOR

MERONI (I)
BIB
CAROLI
LAMA
NOVOTECNICA
+ EVERGOOD (71)

PER:
FOR:

MERONI

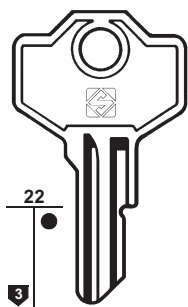

MER7R

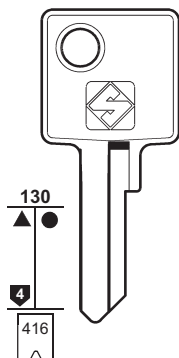

MER2

... 1-294
... 301-400
... 401-694
... 941-975



CAROLI

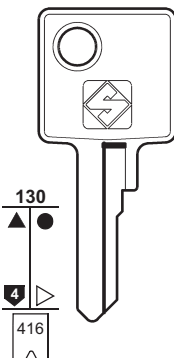

MER24

... 1-294

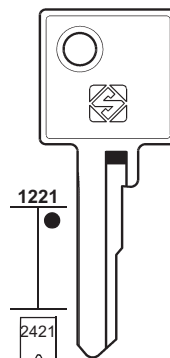

MER29

... 1-294
... 301-400
... 401-694
... 941-975

PER:
FOR:

MERONI

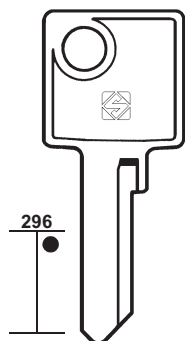

MER23
PREMI-APRI

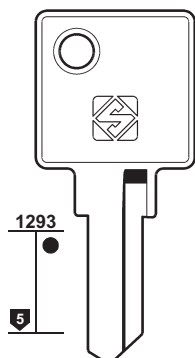

MER31

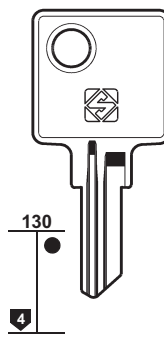

MER32



124

PER / FOR

MERONI (I)
 EBA
 IJ
 JTF
 MING-TAY
 WINFOR
 + EVERGOOD (71)

PER:
FOR:

MERONI

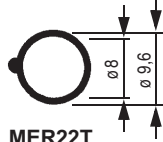
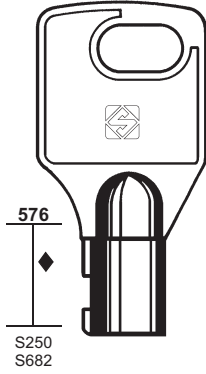

MER22T
..... 543210

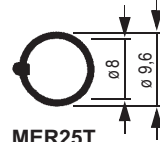
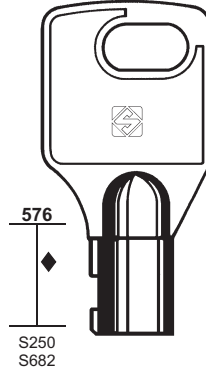

MER25T
..... 543210

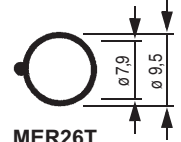
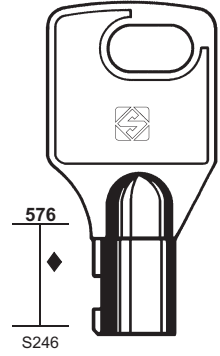

MER26T
..... 10000-10998



MING-TAY - WINFOR

PER:
FOR:

MERONI

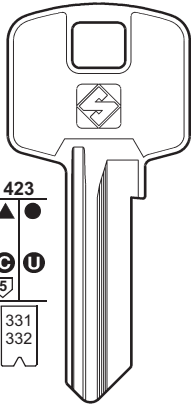

MER8

..... T
 0-1-2-3-4-5-6-7-8-9
 M.....
 0-1-2-3-4-5-6-7-8-9
 PREMI-APRI
 EBA - IJ - JTF

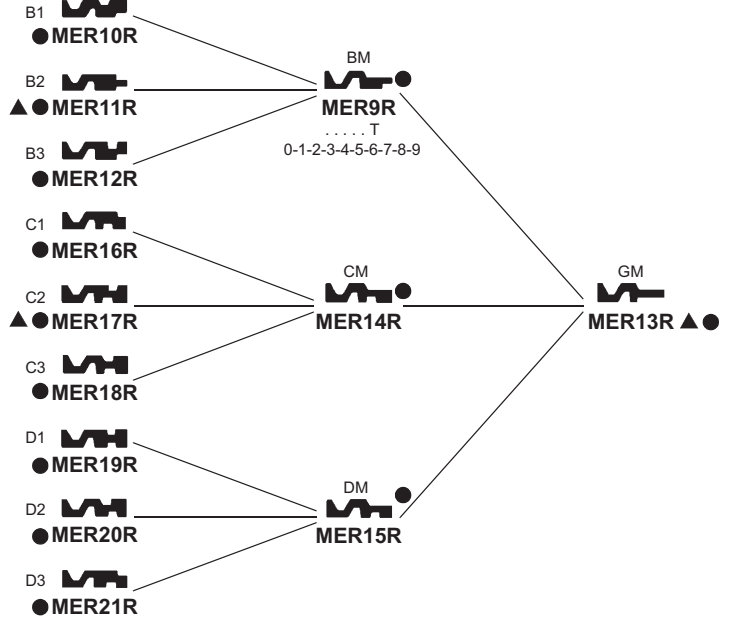

PER:
FOR:

MERONI

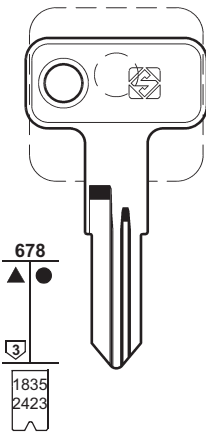

MER33R

... 0-1-2-3
 ... 1-709
 CB ... 1-709

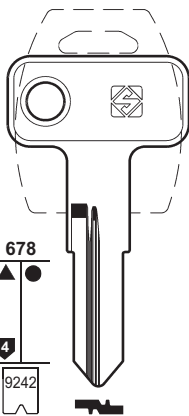

MER34R

CC 4001-4650

MER35R

CD

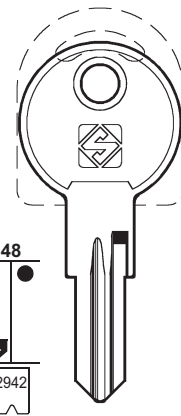

MER36

..... 1234

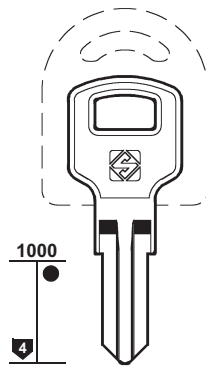



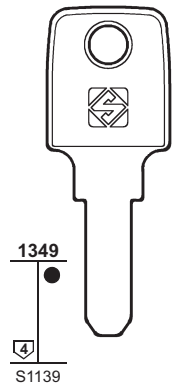





MER37

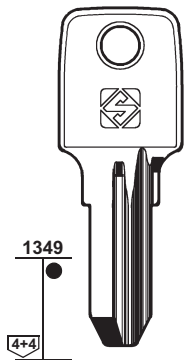

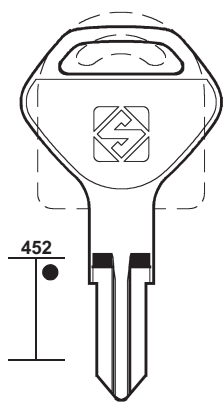
MER39

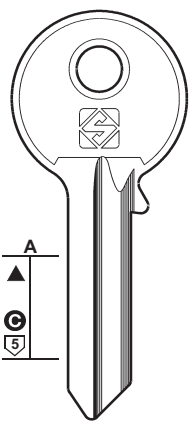
WA

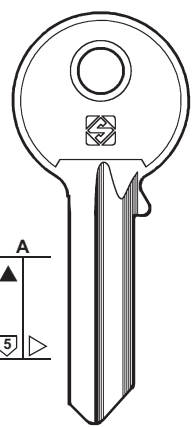



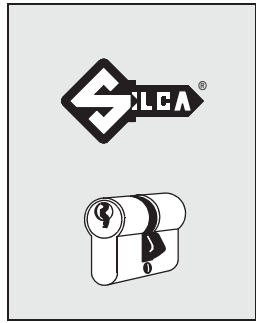





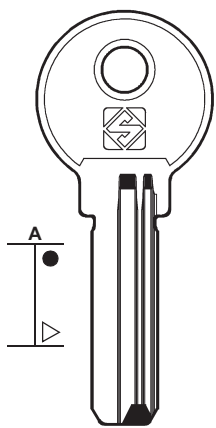

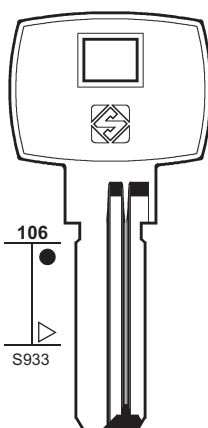

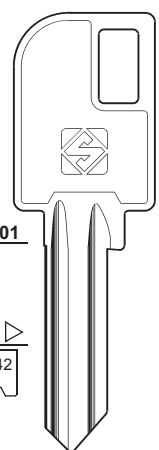

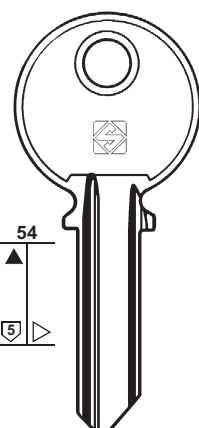



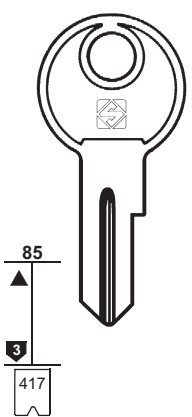

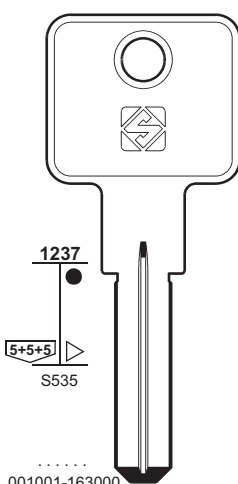

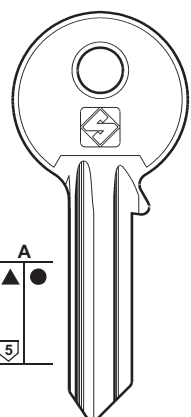
<p>PER: FOR:</p> <p style="text-align: center;">MERONI</p> <div style="display: flex; justify-content: space-around;"> <div style="text-align: center;">  <p>1349</p> <p>4+4</p>  <p>MER38</p>  </div> <div style="text-align: center;">  <p>452</p>  <p>MER41</p>  </div> </div>	<p style="text-align: center;">METAL</p> <div style="display: flex; justify-content: space-around;"> <div style="text-align: center;">  <p>A</p> <p>5</p>  <p>MTA1R</p>  </div> <div style="text-align: center;">  <p>A</p> <p>5</p>  <p>MTA3R</p>  </div> </div>
--	--

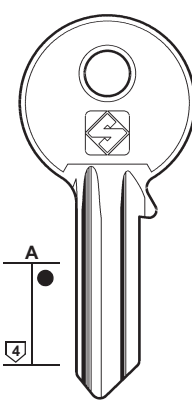

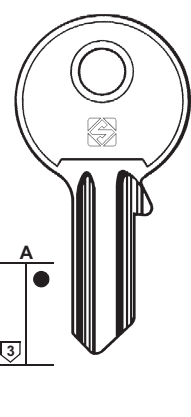
125

- PER / FOR**
- MERONI** (I)
 - + EVERGOOD (71)
 - METAL** (BG)
 - + OJMAR (134)
 - METALCASTELLI** (I)
 - + GIUSSANI (86)
 - + HEKNA (92)
 - + PREFER (143)
 - METALUX** (F)
 - + TESA (165)
 - + VACHETTE (181)
 - METEOR** (F)
 - + BKS (31)
 - + DOM (61)
 - + KIFERM (106)
 - METIZ** (UA)
 - + KIEV (106)
 - MG (MONTI)** (I)

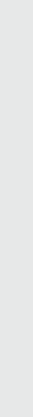
<p>PER: FOR:</p> <p style="text-align: center;">METAL</p> <div style="display: flex; justify-content: space-around;"> <div style="text-align: center;">  <p>A</p>  <p>MTA4</p>  </div> <div style="text-align: center;">  <p>106</p> <p>S933</p>  <p>MTA2</p>  </div> </div>	<p style="text-align: center;">METALUX</p> <div style="display: flex; justify-content: space-around;"> <div style="text-align: center;">  <p>1001</p> <p>5</p> <p>442</p>  <p>MX1</p> <p>..... 1001-2178</p> <p>L..... 1001-2178</p> <p>..... 1234567</p> <p>L..... 14001-14500</p> <p>L..... 15001-18199</p> <p>..... 20001-20625</p> </div> <div style="text-align: center;">  <p>54</p> <p>5</p>  <p>MX5</p> </div> </div>
---	--

<p>PER: FOR:</p> <p style="text-align: center;">METEOR</p> <div style="text-align: center;">  <p>85</p> <p>3</p> <p>417</p>  <p>MET1</p> <p>B... 1-600</p> <p>G... 1-600</p> </div>	<p style="text-align: center;">MG (MONTI)</p> <div style="display: flex; justify-content: space-around;"> <div style="text-align: center;">  <p>1237</p> <p>5+5+5</p> <p>S535</p> <p>.....</p> <p>001001-163000</p>  <p>MG8</p> <p>PBA</p>  </div> <div style="text-align: center;">  <p>A</p> <p>5</p>  <p>MG1</p> </div> <div style="text-align: center;">  <p>A</p> <p>5</p>  <p>MG1R</p> </div> <div style="text-align: center;">  <p>A</p> <p>4</p>  <p>MG2</p> </div> <div style="text-align: center;">  <p>A</p> <p>3</p>  <p>MG2R</p> </div> <div style="text-align: center;">  <p>A</p> <p>3</p>  <p>MG3</p> </div> </div>
---	---



126

PER / FOR

MG (MONTI) (I)

MIAN-FORCE (RC)

GLOBE (87)

MIBRA (GB)

L & F (116)

MICHEL-SEAT (I)

+ **O.M.R.** (136)

+ **POTENT** (142)

+ **SEAT** (152)

MILA (DK)

+ **EVO** (72)

MILANO (BR)

MILES (RUS)

MING-TAY (RC)

SOS

+ **MERONI** (124)

MIPPART (D)

DOM (62)

MIT (I)

INDESIT (96)

PER:
FOR:

MG (MONTI)

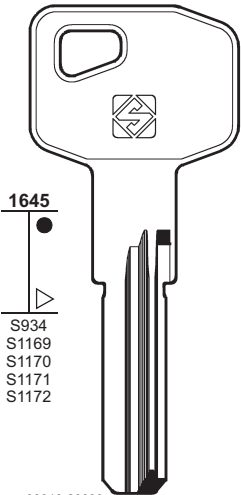

A5 00010-28000
A6 00010-28000
A7 00010-28000
A8 00010-28000

MG9
X8



MICHEL-SEAT

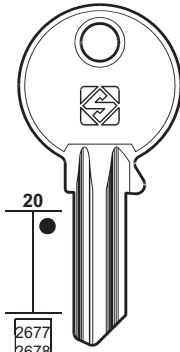

MH1
... 201-436

MH1R
... 437-672

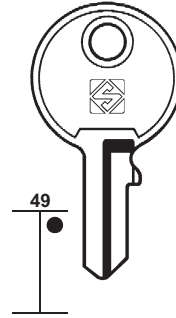

SEA4

SEA4R

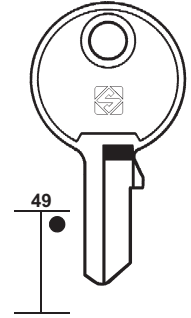

MH5R



PER:
FOR:

MILA

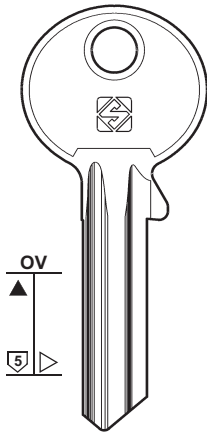

MIL1

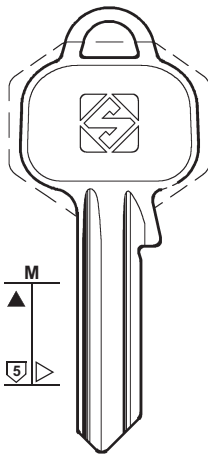

MIL2

MILANO

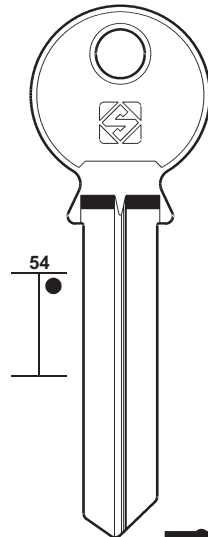

MLN3

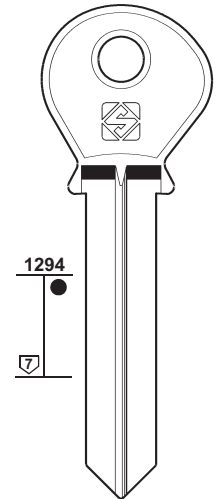

MLN1

PER:
FOR:

MILES

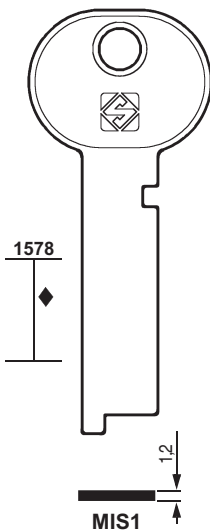

MIS1

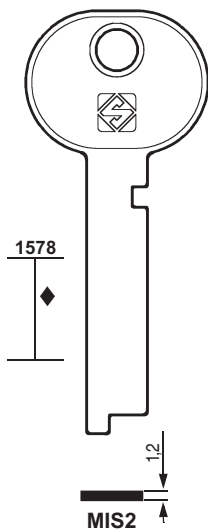

MIS2



MING-TAY

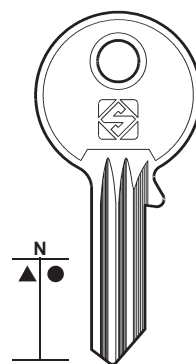

MTY1

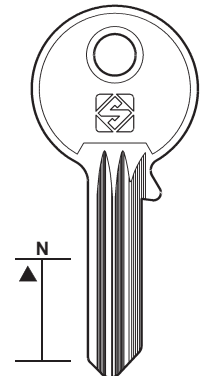

MTY2

SOS

PER:
FOR:

MIWA

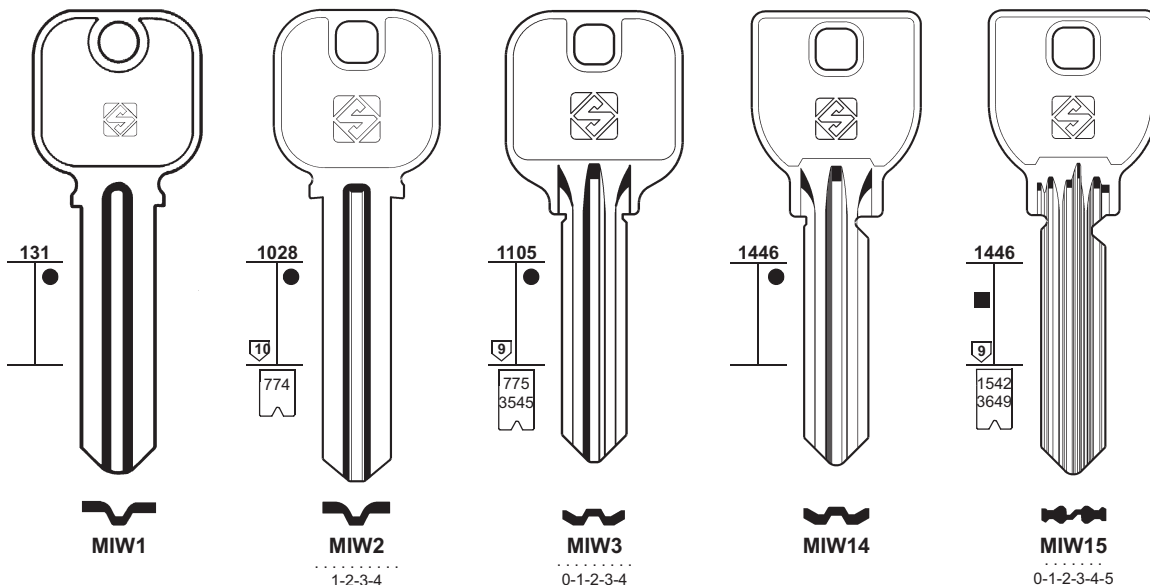

NITI LOCKS



127

PER / FOR

MIWA (J)
NITI LOCKS

MLM (D)
DOM
LEHEMANN
ORDO
STUV

- + DOM (61-62)
- + OJMAR (134)
- + RONIS (147)

MLP (I)
GIUSSANI
+ GIUSSANI (86-87)

PER:
FOR:

MIWA

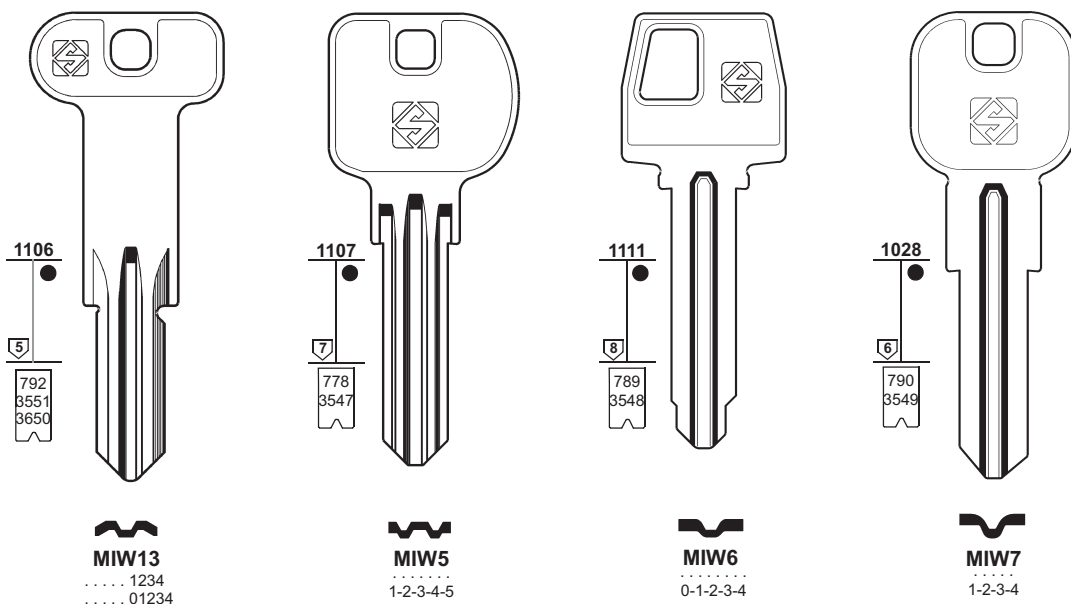

PER:
FOR:

MLM

MLP

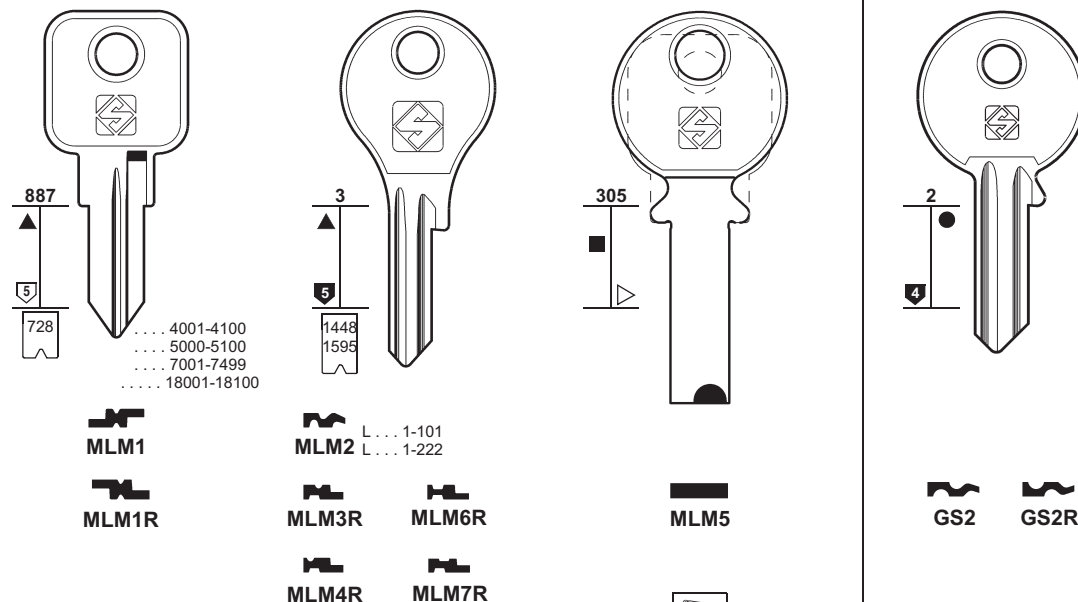

DOM - LEHEMANN - ORDO - STUV

GIUSSANI



128

PER / FOR

MOBELLA (S)

MODA (F)
PICARDIE (141)

MODERN (RC)

MODERN BAU (D)
VACHETTE (181)

MOFLEX (E)
OJMAR (134)

MON (E)

MONACOR (RC)
ALPHA (15)

MONDIAL (F)
G.R. (89)
RONIS (146)

MONDRAGON (E)
MCM (120)

MONOBLOC (F)
FO
+ ZENITH (201)

MONTI-MG (I)

MOREAUX (F)
DOM (63)
RONIS (146)
WALLY (188)

MORI E. (I)
CRISTIANI
LML
LR
TAMPALINI
ZANI
+ FIAM (79)

PER: FOR:	MOBELLA	MODERN	MON	MONOBLOC
	... 1-2-3-4			FO

PER: FOR:	MONTI-MG									

PER: FOR:	MONTI-MG		MORI E.		

CRISTIANI - LML - LR - TAMPALINI - ZANI

PER: FOR:	MORI E.	MORI G.
	<p>472 1556 1-2-3-4-5-6</p> <p>MI3 MI7 MI7R</p>	<p>A A</p> <p>MIG1 MIG2</p>
	FEB	



129

- PER / FOR
- MORI E. (I)
FEB
+ FIAM (79)
 - MORI G. (I)
 - MOSCON (RUS)
 - MOSRENTGEN (RUS)
 - MOTORSICH (UA)
 - MOTTA (BR)
 - MOTTURA (I)
 GEVY (86)
 - MP-PLODARI (I)

PER: FOR:	MOSCON	MOSRENTGEN	MOTORSICH
	<p>1081</p> <p>MSC1</p>	<p>1101</p> <p>MST1</p>	<p>1147</p> <p>MTS1 MTS1R</p>

PER: FOR:	MOTTA	MP-PLODARI
	<p>1532 1532</p> <p>MTT1R MTT2R</p>	<p>A A 26</p> <p>▲ MP230 MP231 ▲ MP228 MP229</p> <p>MP101</p>



130

PER / FOR

MP-PLODARI (I)

M.S.S. (P)

MST (I)

CAS-CISMA (40)

MSV (P)

MUKRA (D)

CORBIN (53)

MULT-LEI (GR)

MULT (BR)

MUL.T.LOCK (IL)

GARRISON

+ CORNI (55)

PER: **MP-PLODARI**

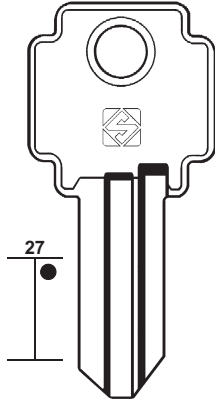

27



MP102



MP103 ▲●



MP104



MP105

PER: **M.S.S.**

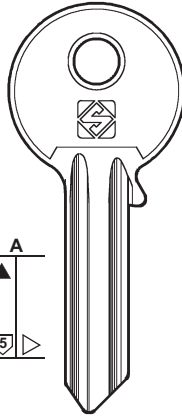

MSF1

PER: **MSV**

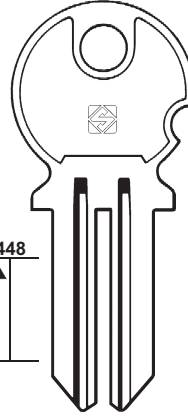

MSV1



MSV1R

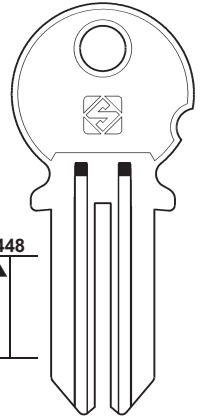

MSV2



MSV2R

PER: **MULT-LEI**

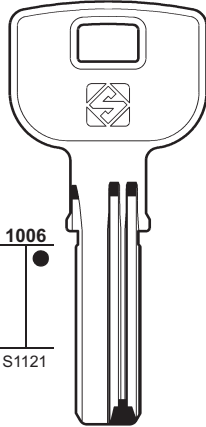

1006

S1121



MTL1



PER: **MULT**

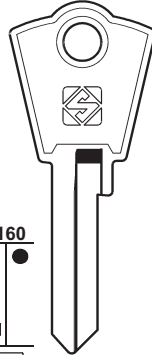

1160

644

..... 1-2-3-4-5



MUL1

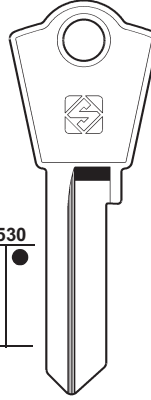

1530



MUL2

PER: **MUL.T.LOCK**

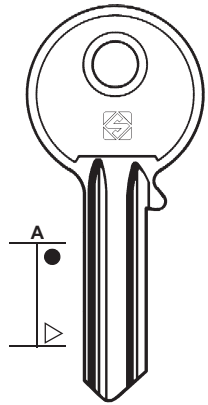

A



MTK5



MTK5R

PER: **MUL.T.LOCK**

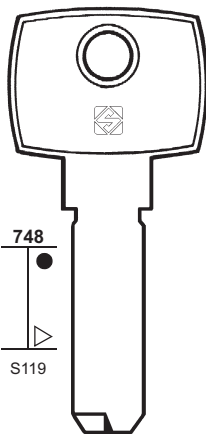

748

S119

J.....
9001-9766

MTK1

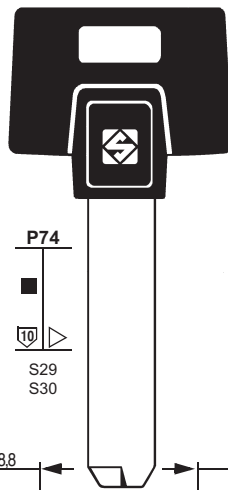

P74

S29

S30

88

MTK2P
(006)

ABCD-12345



9

MTK3P
(006)

ABCD-12345-01

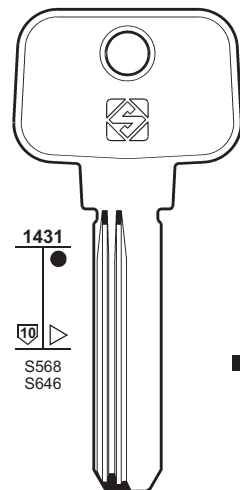

1431

S568

S646

MTK11R
06



MTK15R
66

MTK16
11

MTK12R
08
(008)
ABCD-12345

MTK13R
77

GARRISON

PER:
FOR:

MUL.T.LOCK



131

PER / FOR

MUL.T.LOCK (IL)
GARRISON
SP

+ CORNI (55)

NABOB (IL)

NAIKI (J)

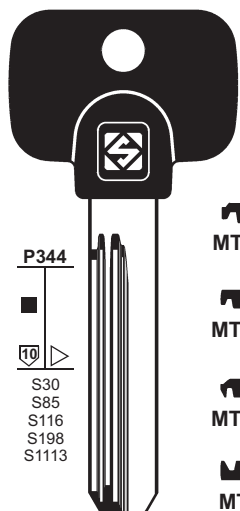

MTK9RP

P344



S30
S85
S116
S198
S1113

(006)
MTK8RP ABCD-12345-01
64

(006)
MTK7RP ABCD-12345-01
50

(005)
MTK4P ABCD-12345
05

(006)
ABCD-12345-01 **MTK10RP**

(006)
MTK4RP ABCD-12345-01
06



SP

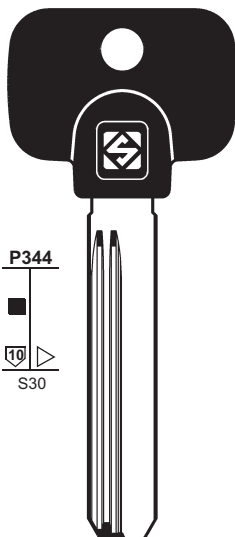

MTK4RPX
06

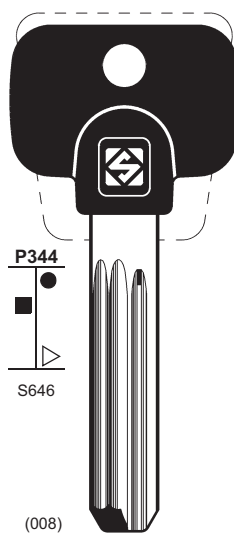

(008)
ABCD-12345

MTK12RP
08



PER:
FOR:

MUL.T.LOCK

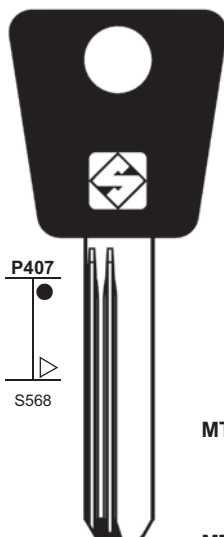

MTK15RAP
66

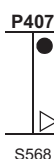

S568

MTK13RAP
77



GARRISON

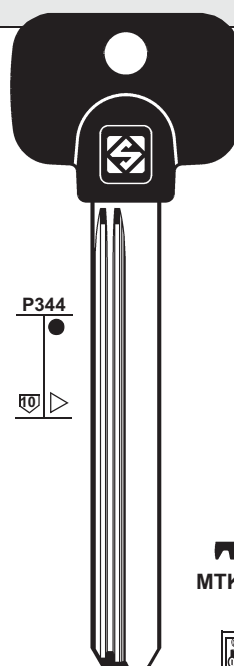

MTK14RP



P344



PER:
FOR:

NABOB

NAIKI

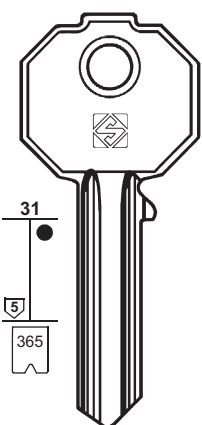

NAB1
.....

0-1-2-3-4-5-6-7-8

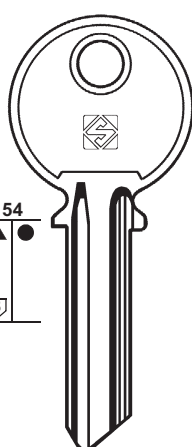

NAB2

NAB1R
NAB5
8

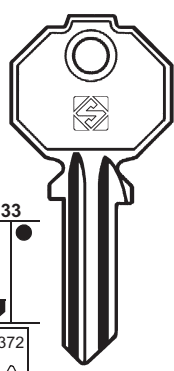

NAB3R
.....

0-1-2-3-4-5-6

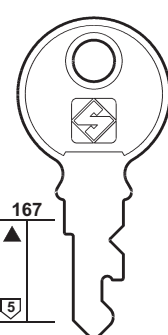

NR1R

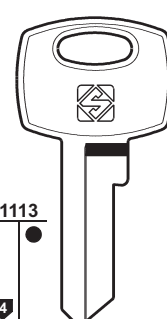

NK1
H...
1-960

NK3
J...
1-960

NK2
E...
1-960



132

PER / FOR

NATIONAL CABINET (USA)
NATIONAL CASH REGISTER
NATIONAL ROCKFORD

NATIONAL CASH REGISTER (USA)
NATIONAL CABINET (132)

NATIONAL LOCK HARDWARE (USA)
NATIONAL ROCKFORD (132)

NATIONAL ROCKFORD (USA)
NATIONAL LOCK HARDWARE
+ NATIONAL CABINET (132)

NAZABAL (E)
EZCURRA (73)

NB (D)
CISA (48)
FLORA (81)

NEC (J)

NELFA (DK)

NEMEF (NL)
+ CES (41-42-43)
+ CORBIN (53)
+ RONIS (147)

NEPTUNE (GB)

NICO (D)
FTH (81)
KFV (105)

NINO (E)
TESA (165)

NITI LOCKS (J)
MIWA (127)

NOBO (N)
DOM (60-61-63)
VING (186)

NONES (I)

NONFANGO (I)

PER:
FOR:

NATIONAL CABINET

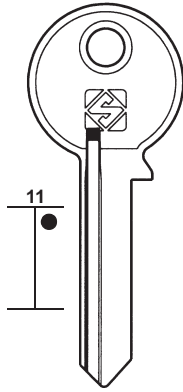

NCR1 NCR1R



NATIONAL CASH REGISTER

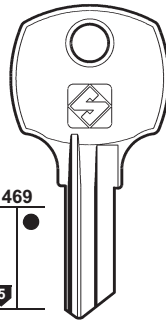

NCR6

NCR11R NCR19

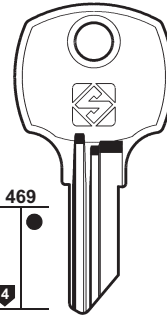

NCR12 NCR13

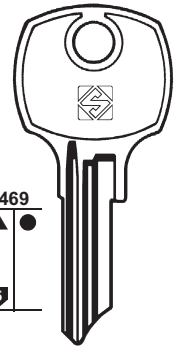

NCR3



NATIONAL ROCKFORD

PER:
FOR:

NATIONAL ROCKFORD

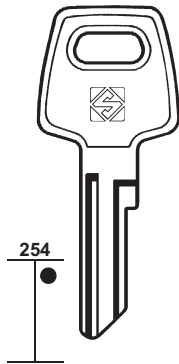

NCR2

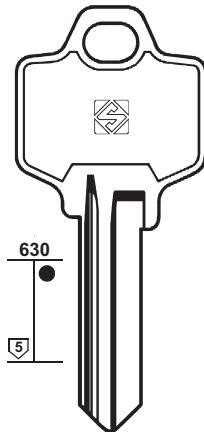

NCR4

NATIONAL LOCK HARDWARE

NEC

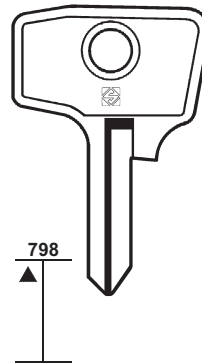

NEC1



NELFA

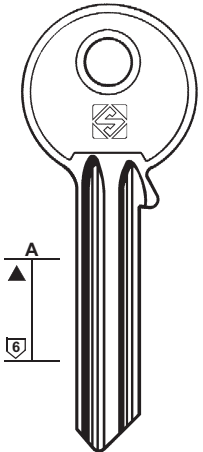

NF1 NF1R

PER:
FOR:

NEMEF

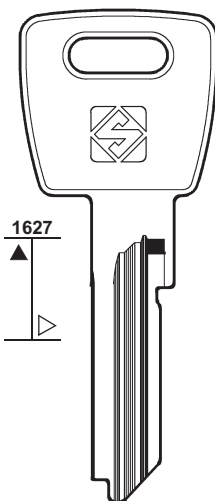

NME1R NME2R

NF1

NEPTUNE

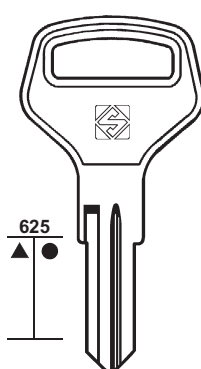

NP1R



NONES

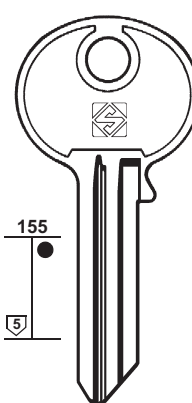

NN1



NONFANGO

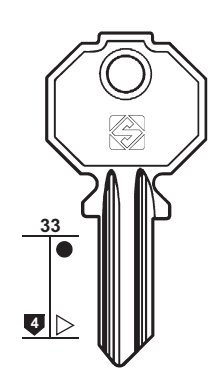

PF12



PER: **NONFANGO**
FOR:

OAL

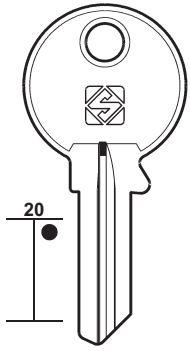

PT1 PT1R

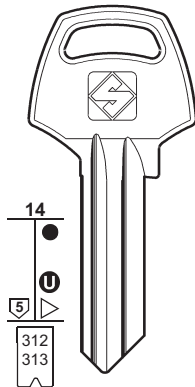

CB1 CB1R

..... 2-3-4-5-6-7-8-9
..... 1-2-3-4-5-6-7-8-9



CORBIN

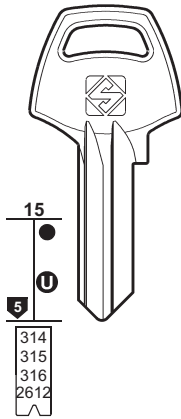

CB3

..... 1-2-3-4-5-6-7-8-9
..... 2-3-4-5-6-7
..... 1-2-3-4-5-6-7-8



CORBIN

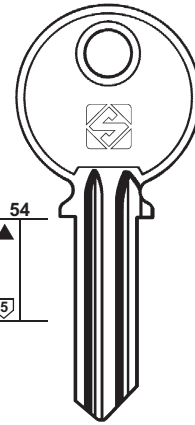

OAL4



133

PER / FOR
NONFANGO (I)

NORDWEST (D)
👁️ FLORA (81)
👁️ SCHLECHTENDAHL (152)

NOVA (D)
👁️ TOP (171)
👁️ YETI (199)

NOVOFERM (I)
👁️ CORBIN (53)

NOVOTECNICA (I)
👁️ MERONI (123)

NUMIDIA (E)
👁️ ESA (69)
👁️ RONIS (146)

OAL (I)
CORBIN
+ 👁️ CORBIN (52)
+ 👁️ GIUSSANI (86)

OB (I)
👁️ ZANETTI A. (200)

OBEL-ODARIA (J)

ODA (NL)
👁️ ANKERSLOT (16)
👁️ CHICAGO (45)

OFFERMANS-FLOOD (RCH)

OJMAR (E)
+ 👁️ CES (41-42)
+ 👁️ HR (93)

PER: **OAL**
FOR:

OBEL-ODARIA

OFFERMANS-FLOOD

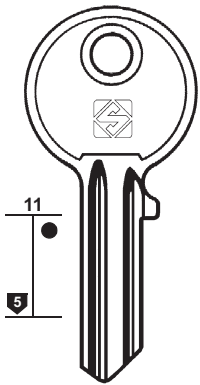

OAL3

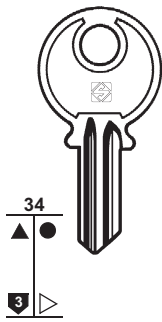

OAL1 OAL1R

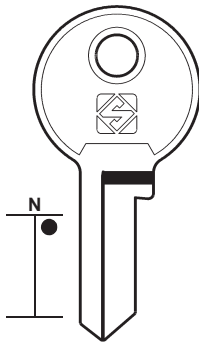

OB1

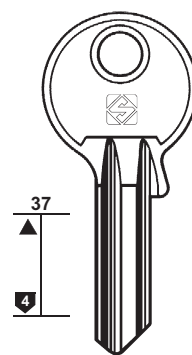

OF4



PER: **OJMAR**
FOR:

OJMAR

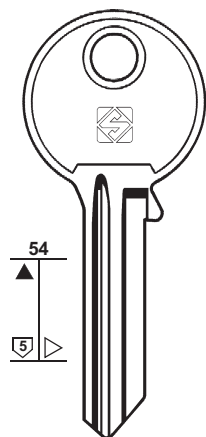

OJ2

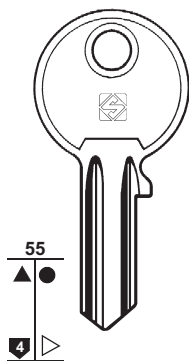

OJ1 OJ1R ▲

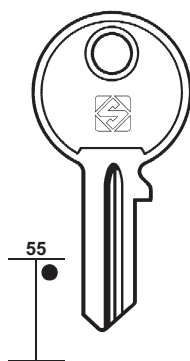

OJ3R

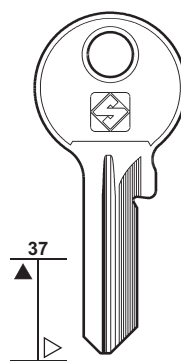

OJ4 OJ4R ▲●

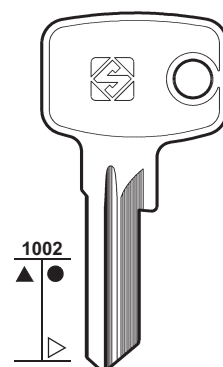

OJ5R

OJ16R

J



134

PER / FOR

OJMAR (E)

BURG
METAL
MLM
MOFLEX
SISO
STUMPF
+ CES (42)
+ HR (93)

OLIVA (I)

FERMABLOCK
PB
PREFER

OLIVETTI (I)

CASIO
 GIOBERT (86)

PER:
FOR:

OJMAR

A1 ... 1-698
S ... 1-698
..... 680
S 680

A ... 1-698
S ... 1-698
U ... 1-698
..... 680

F 680

F1

U 680

BURG - METAL - MOFLEX
SISO - STUMPF

BURG - MLM

..... 0-1-2

5-Q4

PER:
FOR:

OLIVA

OLIVETTI

A

A

616

616

OL5R

OL5

▲ OL4

OL6

OLT1

OLT2

FERMABLOCK - PB - PREFER

PER:
FOR:

OLIVETTI

616

616

616

616

OLT4

OLT5

OLT6R
X

OLT8R
P

CASIO

CASIO

CASIO

CASIO

PER:
FOR:

OLIVETTI

616 616

OLT7
X

OLT3

PER:
FOR:

OMA

54 A A

6 5 4

▲ OA1 OA1R ▲ OA2 OA2R ● ▲ OA3R ●

C.A.R.S. C.A.R.S.

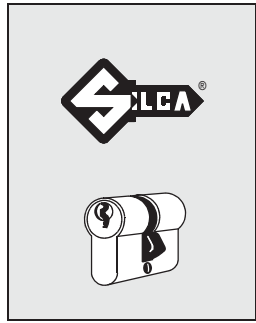

135

PER / FOR

OLIVETTI (I)
GIOBERT (86)

O.M.A. (I)
C.A.R.S.

OMEC (I)
SANTOS

PER:
FOR:

OMEC

1369 29 29 29 29

5 5 4 3 4

3688 3688 333 334

OC5
.....
123456789

OC238 **OC239 ●**

OC236 **OC237 ●**

OC2

OC1
..... 1-2-3-4-5

PER:
FOR:

OMEC

29 1339 1339 1339

5 6 6 6

333 S661 S711 S710
334 S1053

⊕ **OC074** **OC075 ●**

..... 1-2-3-4-5

OC3

OC4
AB
000001-0046656

OC6
BA
000001-0046656



136

PER / FOR

OMIV (I)

CIB
STV
+ BIELLE (30)

O.M.R. (I)

MICHEL-SEAT
+ POTENT (142)
+ PREFER (143)

ONIUN (RC)

UNION (176)

ORBA (D)

SIMECA (155)

ORDO (F)

+ KIFERM (106)
+ LAS (111)
+ MLM (127)

ORION NOVOX (F)

DECAYEUX

ORLANDO (I)

ICSA (94)

ORO (IL)

ORSA (BY)

OSKO (D)

JOWIL (100)

OT (I)

FONDAR (81)

OTHMER (D)

ABUS (6)

OTIS (I)

CES (42)
 ILLINOIS (96)
 ZEISS-IKON (200)

OTTO (I)

BURG (37)

PER:
FOR:

OMIV

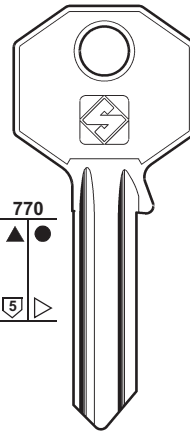
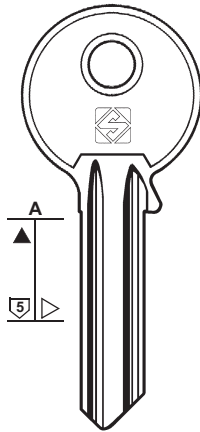
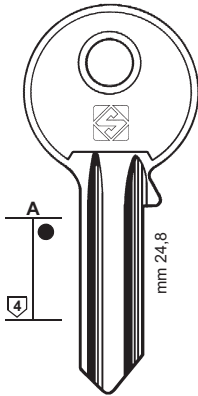

CIB - STV

CIB - STV

O.M.R.

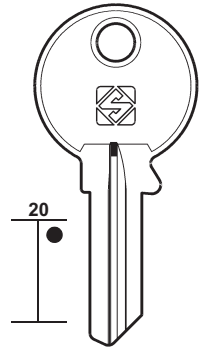
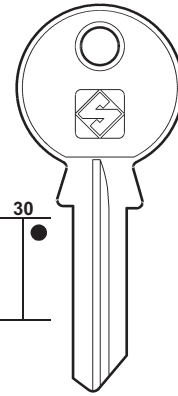

MICHEL-SEAT

PER:
FOR:

O.M.R.

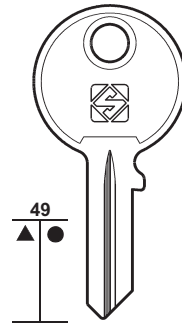
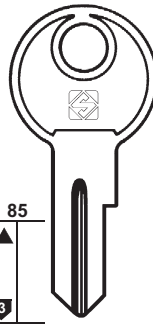
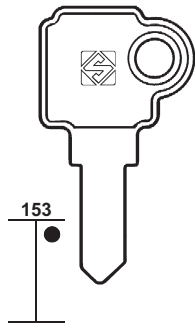

SEA5 SEA5R

MET1

B... 1-600
G... 1-600

OMR1R

SEA7 SEA8

ORDO

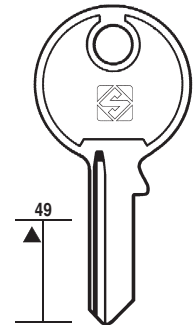

OR1R



MICHEL-SEAT



MICHEL-SEAT



PER:
FOR:

ORION NOVOX

ORO

ORSA

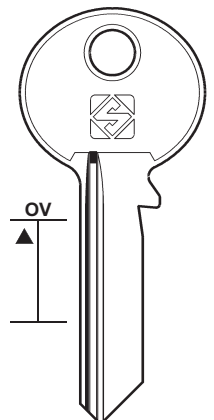
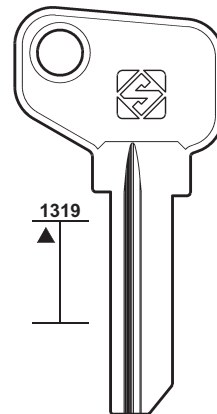
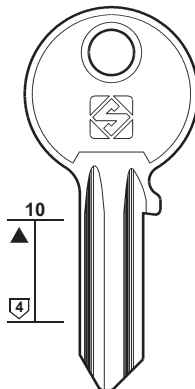
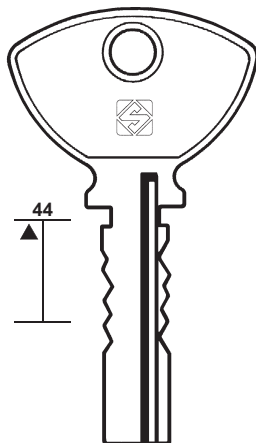

ON1

ON1R

ORO1

● ORO2

ORA1

ORA2

DECAYEUX

PER:
FOR:

PACRI

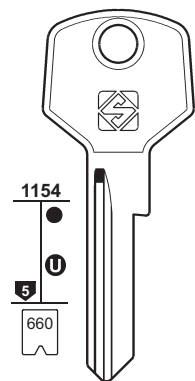

..... 1-2-3-4-5-6-7



PAC1R

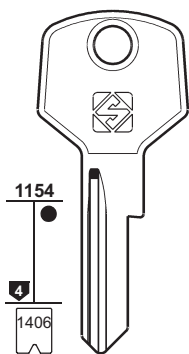

..... 1-2-3-4



PAC2R

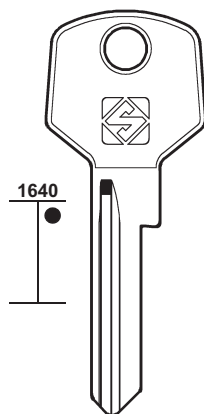

PAC3R

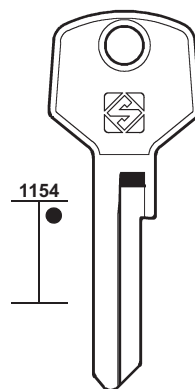

PAC4



137

PER / FOR

PACRI (BR)

PADO (BR)

PER:
FOR:

PADO

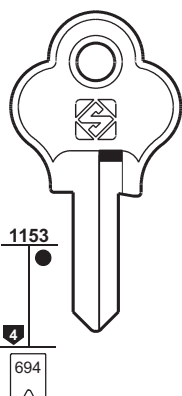

..... 1-2-3



PDO12



PDO12R

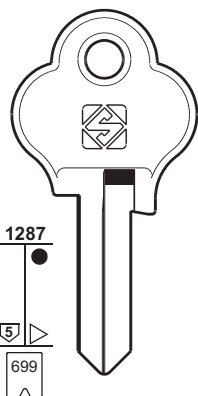

..... 1-2-3-4-5



PDO17



PDO17R

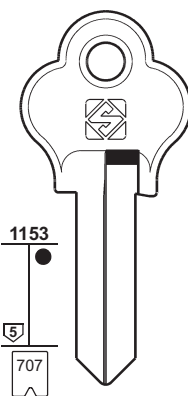

..... 1-2-3-4-5-6



PDO2

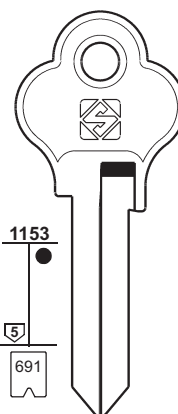

..... 1-2-3-4-5



PDO9



PDO9R

PER:
FOR:

PADO

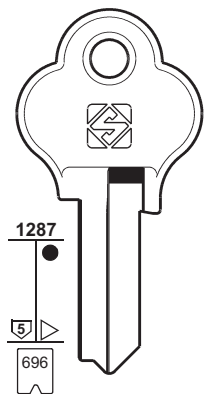

..... 1-2-3-4-5



PDO14



PDO14R

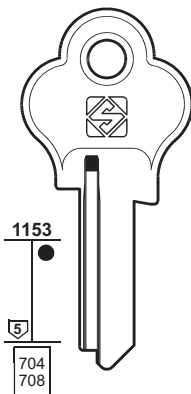

..... 1-2-3-4-5



PDO1R



PDO1R

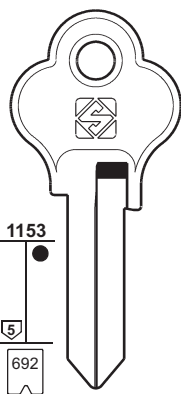

..... 1-2-3-4-5



PDO10R



PDO10R

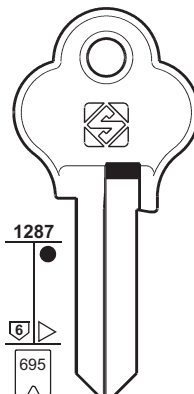

..... 1-2-3-4-5-6



PDO13



PDO13R

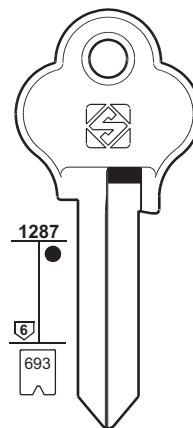

..... 1-2-3-4-5



PDO11



PDO11



138

PER / FOR

PADO (BR)

PANDA (F) (RC)

PANTHER (D)
JOWIL (100)

PAPAIZ (BR)

PER:
FOR:

PADO

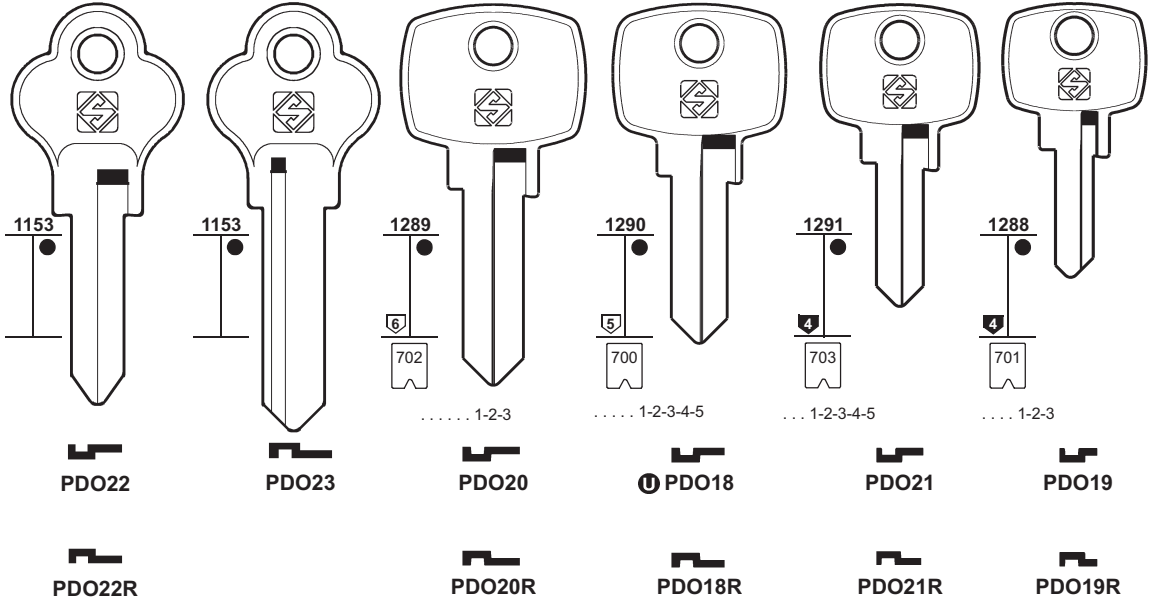

PER:
FOR:

PANDA

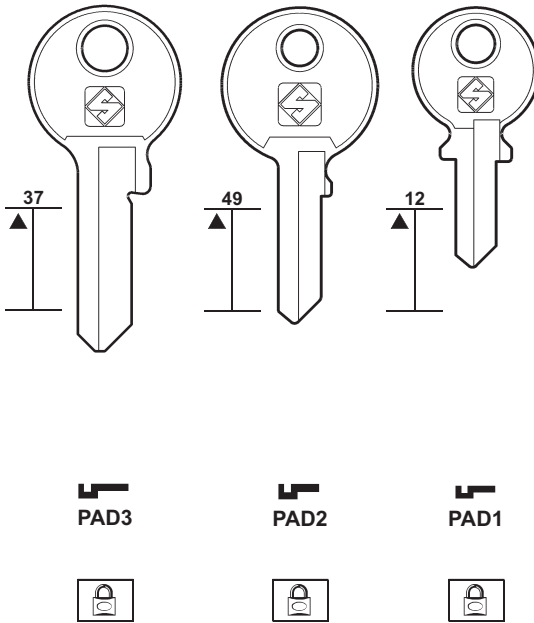

PAPAIZ

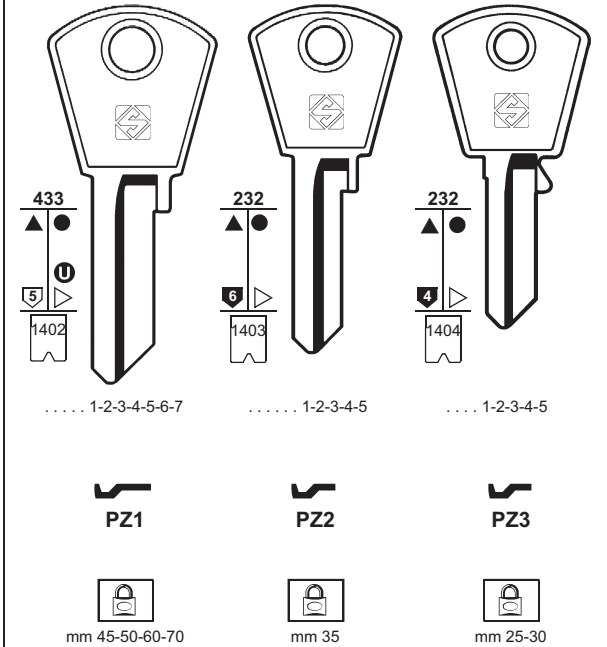

PER:
FOR:

PAPAIZ

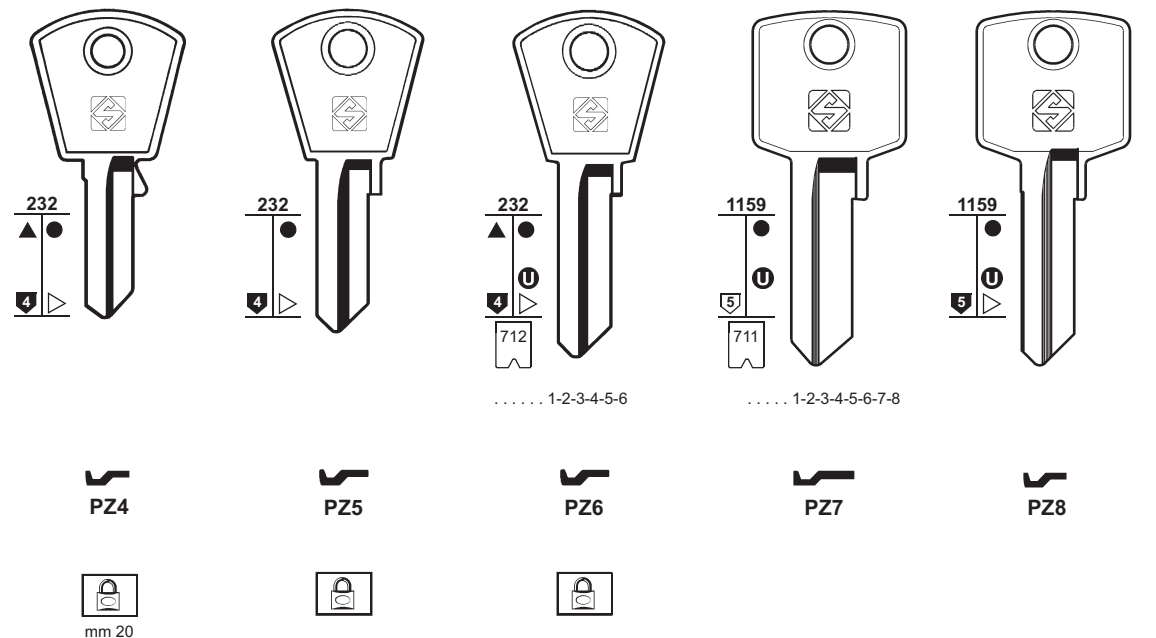

PER:
FOR:

PAPAIZ

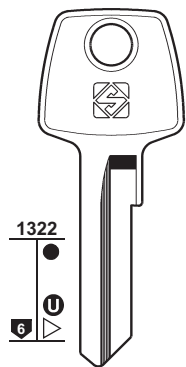

PZ9

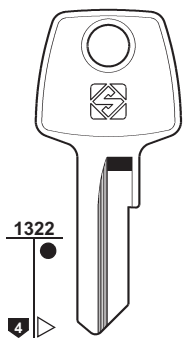

PZ14

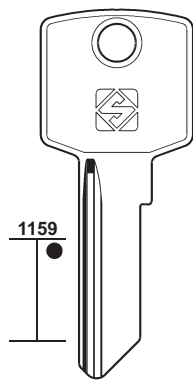

PZ18R

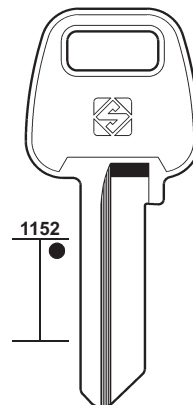

PZ17



139

PER / FOR

PAPAIZ (BR)

PARMA (I)

PAS (I)

👁️ PREFER (143)

PASSY (F)

👁️ RICOUARD (146)

PASTORE (I)

👁️ GIUSSANI (87)

👁️ PREFER (142)

P.B. (I)

👁️ OLIVA (134)

P.C. (CORTELLEZZI) (I)

ETNA

FEB

FPB

FRAL

LUNA

PLODARI

SANTOS

SAVIO

+ 👁️ BIELLE (30)

+ 👁️ JVAL (102)

PER:
FOR:

PAPAIZ

PARMA

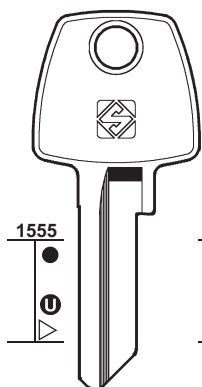

PZ15

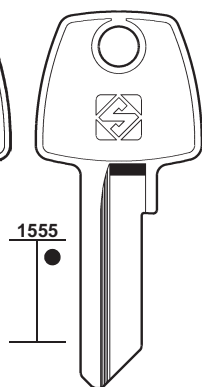

PZ19

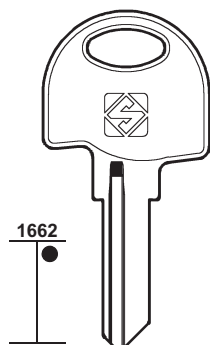

PZ20R

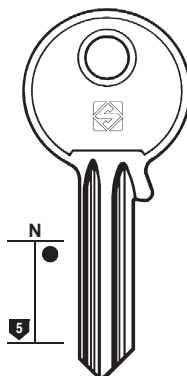

PA2

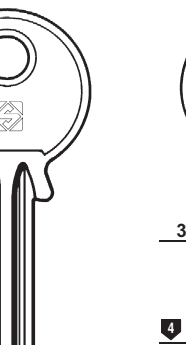

PA1

▲PA2R

PA1R

PER:
FOR:

P.C. (CORTELLEZZI)

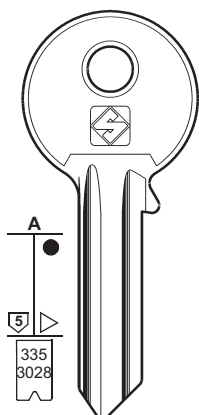

PC14

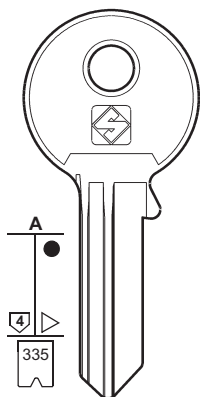

PC20

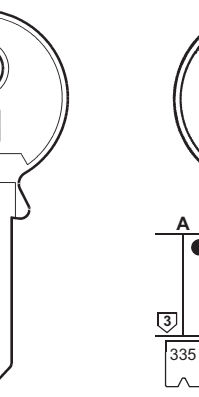

PC18R ▲●

... 1-2-3-4-5

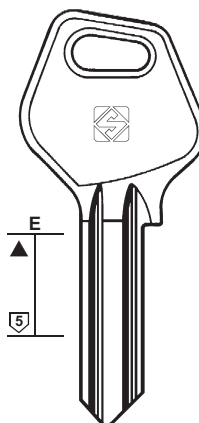

PC13

▲●PC1

PC1R

... 1-2-3-4-5
... 1-2-3-4-5-6-7

PC4

PC4R

... 1-2-3-4-5

PC10

PC10R ▲●

... 1-2-3-4-5

ETNA - FEB - FPB
FRAL - SANTOS - SAVIO

ETNA - FEB
FPB - LUNA - PLODARI



140

PER / FOR

P.C. (CORTELLEZZI) (I)

CASMA
FEB
GEVY
JVAL
R.S.M.
SILCA
SUL

+ BIELLE (30)
+ JVAL (102)

PENZA (RUS)

PERINO PG (I) IMSI

PEROHAUS (F)

DOM (61)
 GEGE (84-85)
 JUNIE (101)

PERRIER (F)

G.R. (90)

PETERBORO (USA)

DOMINION (66)

PER:
FOR:

P.C. (CORTELLEZZI)

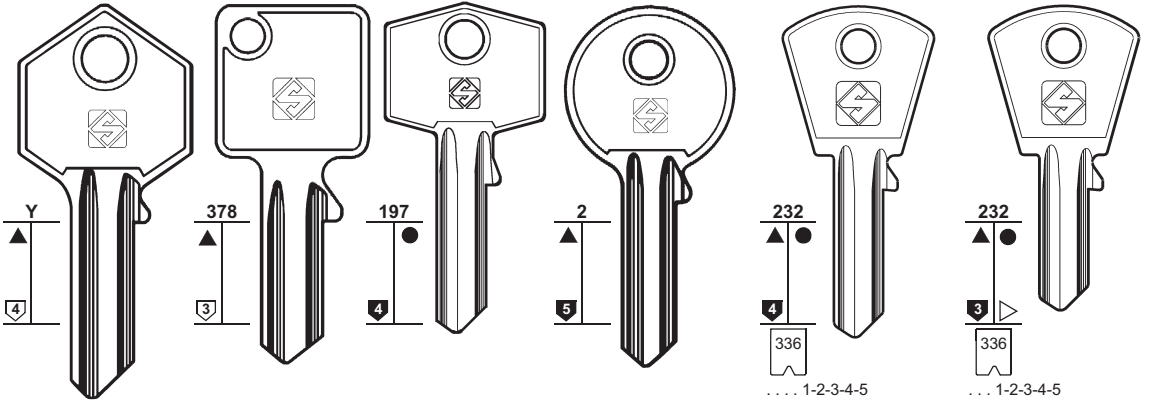

PC11

PC5

PC6

PC8

PC2

PC3

● PC2R

GEVY - R.S.M.

JVAL - SUL

CASMA



PER:
FOR:

P.C. (CORTELLEZZI)

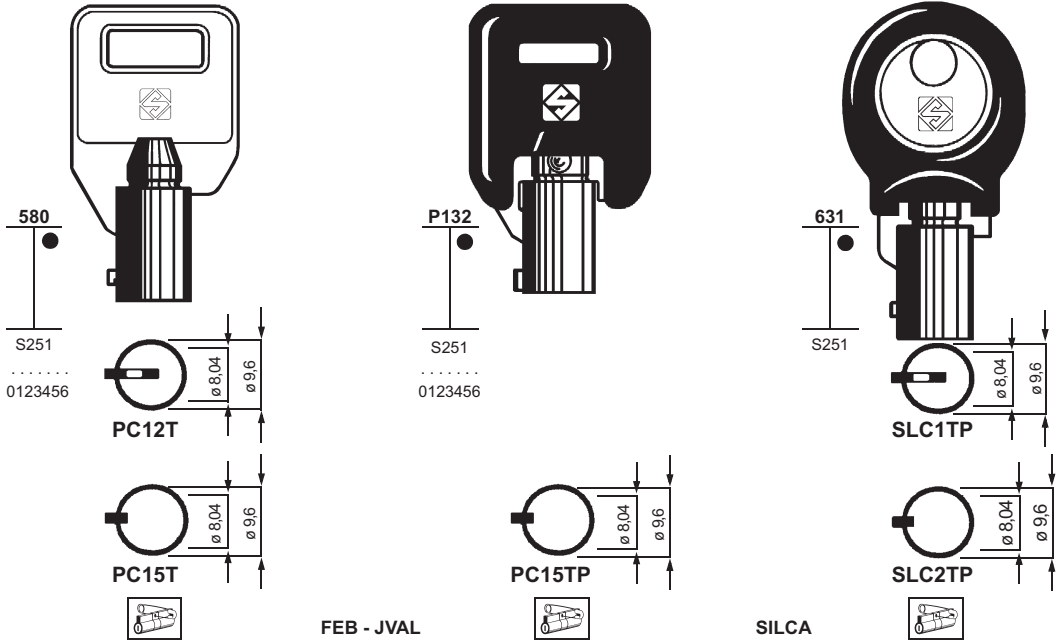

PC12T

PC15T

SLC1TP

PC15TP

SLC2TP

FEB - JVAL

SILCA

PER:
FOR:

PENZA

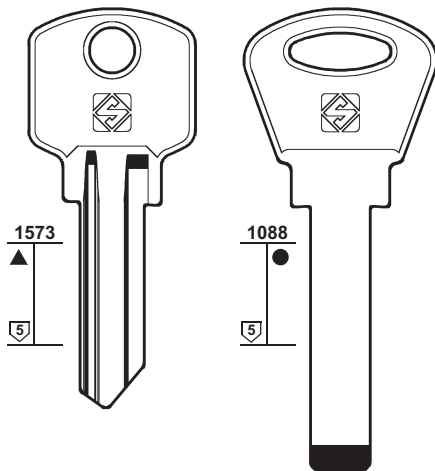

BZ2

BZ2R

BZ3



IMSI

PERINO PG

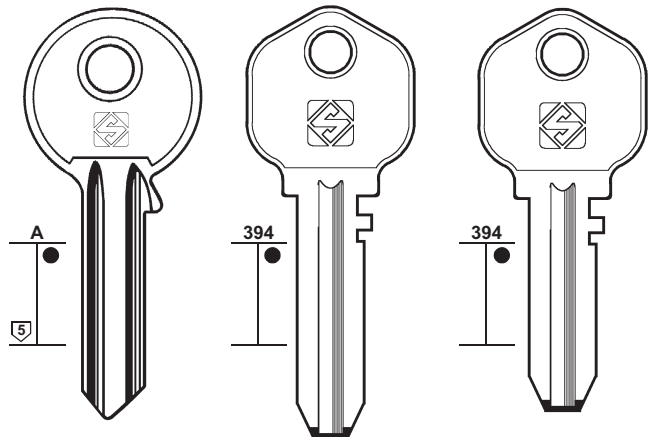

▲ PG1

PG1R

PN1

PN2



IMSI



PER: **PETROZAVODSK**
FOR:

PFAFFENHAIN



141

PER / FOR

PETROZAVODSK
(RUS)

PFAFFENHAIN (D)
ABUS
BUVA

PICARD (F)
BETA (29)
KABA (102)

PICARDIE (F)
DECAYEUX
MODA
S & E
STS
+ AMARO LIMITADA (15)
+ FTH (81)
+ GABON (84)
+ SIS (156)
+ TITAN (167)

P.J. (F)
RONIS (147)

P.K. (F)
LAS (110)

PLG (I)
GIUSSANI (86)

PLODARI (I)
P.C. (139)

PM (F)
RONIS (146-147)

POLI (RCH)

POPLOCK (I)
CORBIN (52-53)

POS (D)
SIGENIA

POTENT (I)
MICHEL (126)

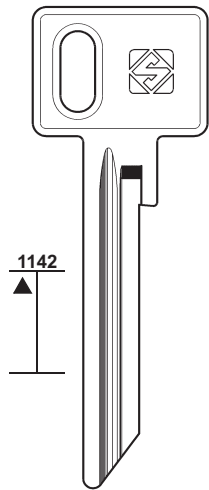

1142

PTZ1R

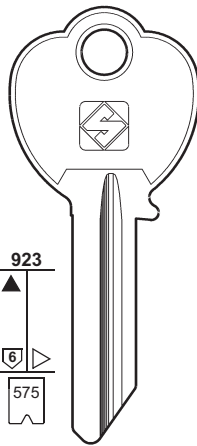

923

6
575

PHF1R
HK

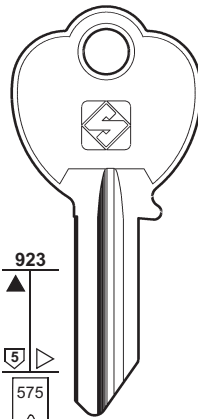

923

5
575

PHF2R
L

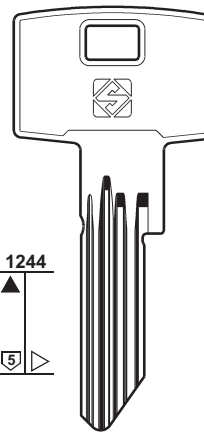

1244

5

PHF7R

PHF8R

PHF9R

PHF10R

PHF11R

PHF12

PHF15

..... X-Y-0-1-2-3-4-5-6-7-8-9 0-1-2-3-4-5-6-7-8-9
..... 25080-58049 1-57036



ABUS

PHF5

PHF6

PHF4R

ABUS

PER: **PFAFFENHAIN**
FOR:

PICARDIE

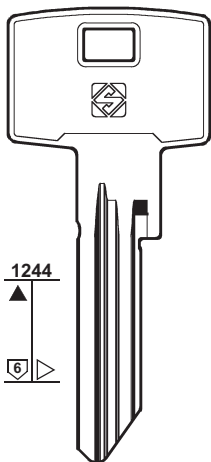

1244

6

PHF16R
SRA
BUVA

PHF23

PHF22R

PHF19
EA

PHF18R
FD

PHF17
ED

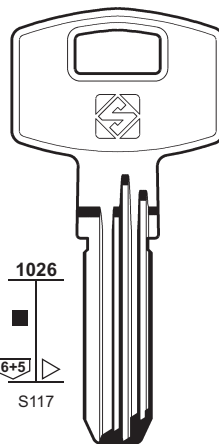

1026

6+5
S117

PIC1

DECAYEUX - MODA
S & E - STS

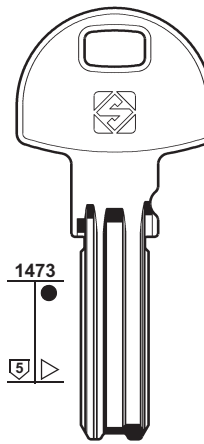

1473

5

PIC2



PER: **POLI**
FOR:

POS

POTENT

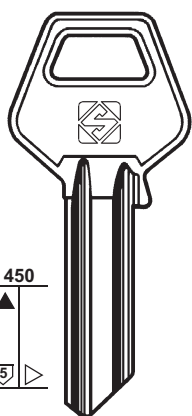

450

5

PL1

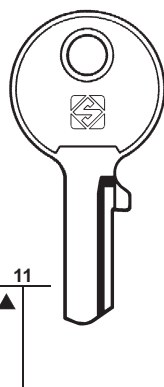

11

PS1
CZ

SIGENIA

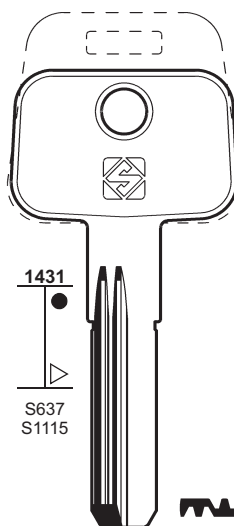

1431

S637
S1115

PT4R

..... 1-2-3-4-5

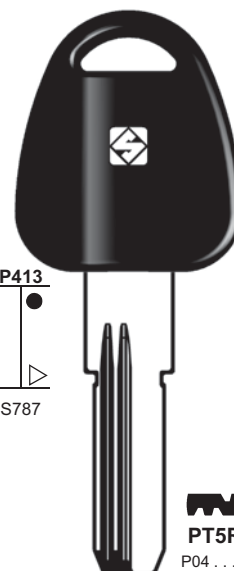

P413

S787

PT5RP

P04
1-2-3-4-5-6





142

PER / FOR

POTENT (I)

AM
MICHEL
NONFANGO
O.M.R.

+ MICHEL (126)

PREFER (I)

BLOCUS
CAP
CIB
FATTORINI
JIP
PASTORE
PROMO
UNIFOR

+ OLIVA (134)

+ TRAU (172)

PER:
FOR:

POTENT

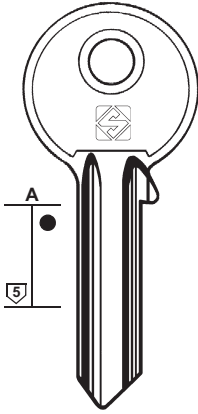

PT2

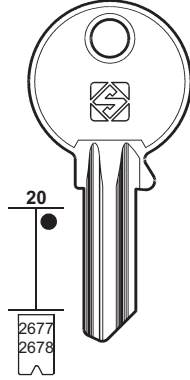

MH1
... 201-436



MH1R
... 437-672



MICHEL

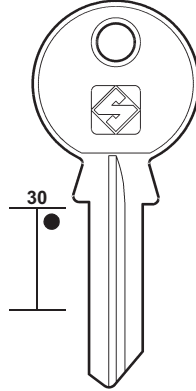

MH2



MH2R

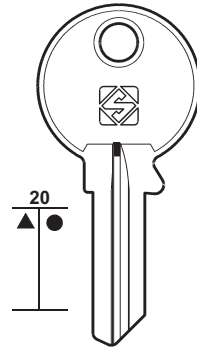

PT1



PT1R



AM
MICHEL
NONFANGO

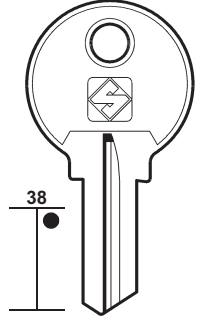

MH4



MH4R



MICHEL
O.M.R.

PER:
FOR:

PREFER

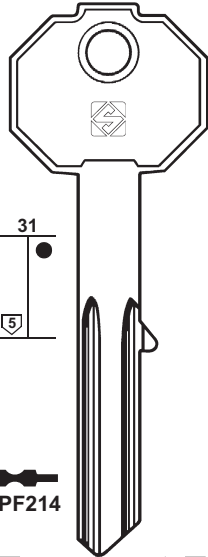

PF214



PF215

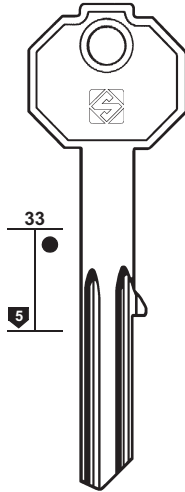

PF215R

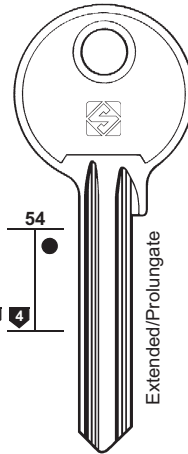

PF3



PF3R



PF11



PF11R

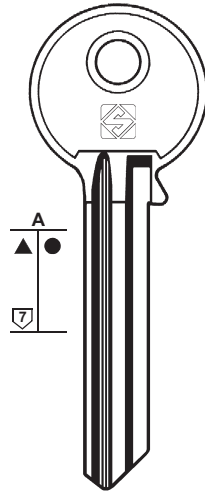

PF7



PF7S

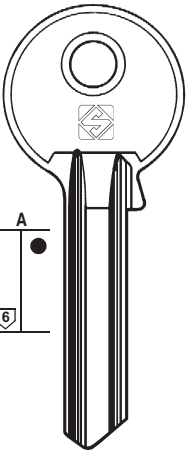

PF8



PF8R

PER:
FOR:

PREFER

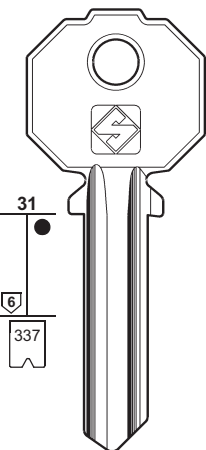

PF6



PF6R

... 1-2-3-4-5

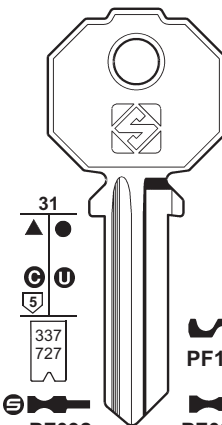

PF92

... 1-2-3-4-5



PF16R



PF92S

... 1-2-3-4-5



BLOCUS - CAP - CIB - JIP
PASTORE - PROMO

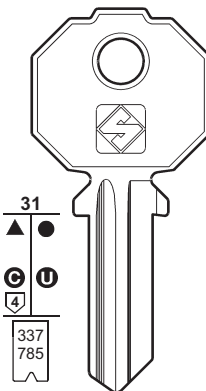

PF2

... 1-2-3-4-5



PF2S

... 1-2-3-4-5



BLOCUS - CAP - CIB
FATTORINI - PASTORE - PROMO

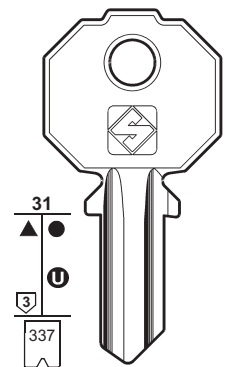

PF5

... 1-2-3-4-5



PF5S

... 1-2-3-4-5



UNIFOR

PER:
FOR:

PREFER

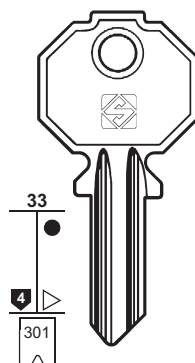
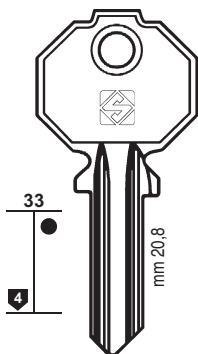
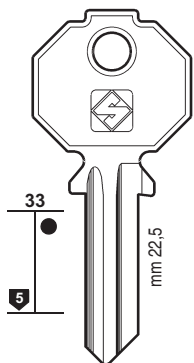
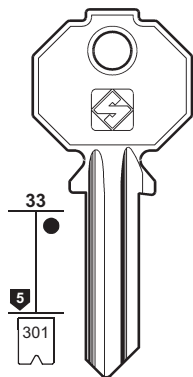

▲ PF072
..... 1-2-3-4-5

PF073

PF15 ▲ PF19

PF9 PF9R

PF12
... 501-700



NONFANGO



143

PER / FOR

PREFER (I)
FOSAM
IMBAC
LIPS VAGO
METALCASTELLI
NONFANGO
O.M.R.
PAS
SERITAL
SWEDA
+ OLIVA (134)
+ TRAU (172)

PRESTA (D)
 BOMORO (33)
 LA PORTE (110)

PER:
FOR:

PREFER

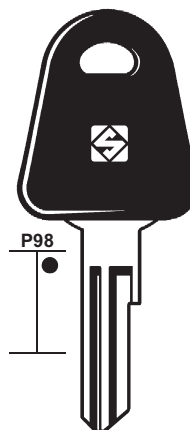
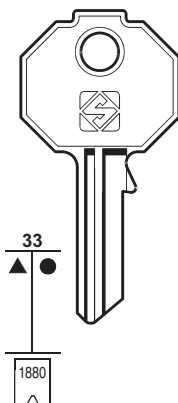
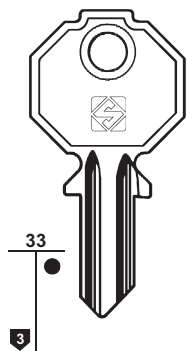
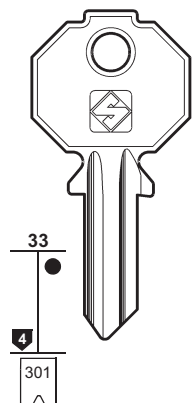

▲ PF070 PF071
..... 501-700

PF4 PF4R

PF1R PF1
..... 1234

PF1RP ▲ PF1P



LIPS VAGO - PAS - SWEDA

FOSAM

METALCASTELLI
SERITAL - O.M.R.

METALCASTELLI

PER:
FOR:

PREFER

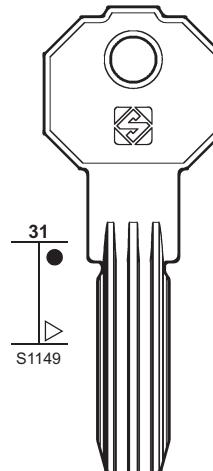
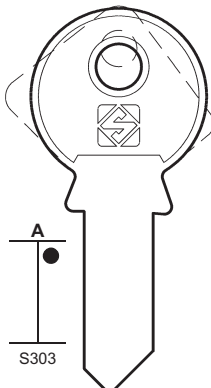
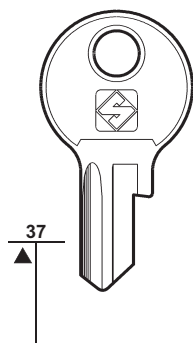
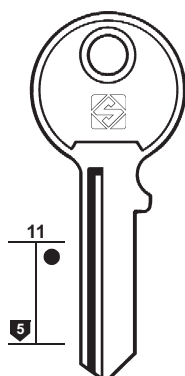

PF13R

PF14

PF18

PF20



IMBAC





144

PER / FOR

PRIM (CH)

PRIVE (RA)
YALE (193)

PROBAT (F)
FTH (81)

PROFILMAR (F)

PROMECA (F)
RONIS (146)

PROMETA (I)

PROMO (I)
PREFER (142)

PROTEC (F)
CITY (51)
KVR (108)

PUNDRRA (USA)

QCP (F)
CITY (51)
ZENITH (201)

RABBIT (HK)

RAFI (D)
DOM (61)

RAM (RC)
YETI (198-199)

RAMIS (ET)

RAUCO (D)
HEKNA (92)

R.C. (I)
CRISTANI (56)

READING (USA)
SEGAL (153)

RECA (I)
INDESIT (96)

REDY (IND)
LOB (114)

REGAL (GB)

REGENT (USA)
HEKNA (92)
HENDERSON (93)

REGISTRATORI DI CASSA (I)

RELIANCE (J)

REMO (I)
ICSA (94)

PER: FOR:	PRIM	PROFILMAR	PROMETA	PUNDRRA

PER: FOR:	RABBIT	RAMIS	REGAL
 0-1-2-3-4-5-6-7-8-9	FP... 626-750	

PER: FOR:	REGISTRATORI DI CASSA	RELIANCE

PER:
FOR:

RENZ

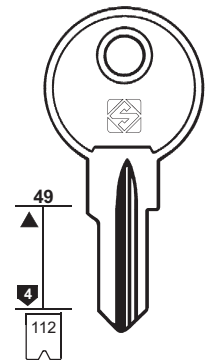

KI5
C ... 1-275
XS ... 1-275

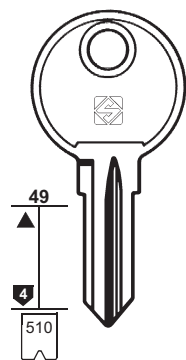

KI5R
SX ... 1-275
XT ... 1-75
RX ... 1-275

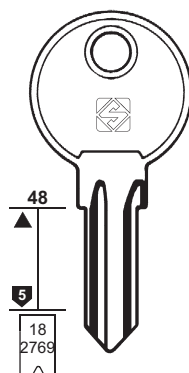

KI12 ... 151-218
... 101-150
... 1116-7776
H ... 1116-7776
E ... 425-499

KI12R ... 1-68
... 51-100
H ... 500-574
E ... 1116-7776

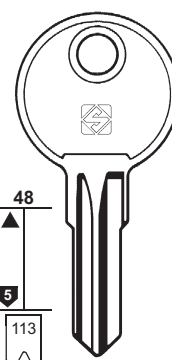

LS1 R ... 1-224

LS1R V ... 1-224

LS2 AX ... 1-224

KI7
XY ... 1-275

ATAL



145

PER / FOR

RENZ (D)
ATAL
+ KIFERM (106)
+ LAS (110)

RESMINI (I)

REX (DK)

PER:
FOR:

RENZ

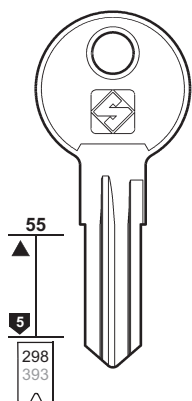

REN1 REN1R
... 1-200

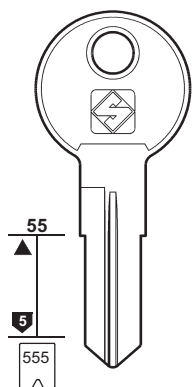

REN2 REN2R
32 ... 001-200

REN4R

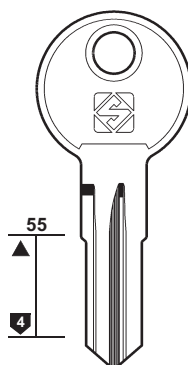

REN3R

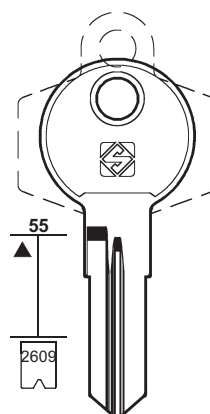

REN5R
ER ... 1-500



PER:
FOR:

RESMINI

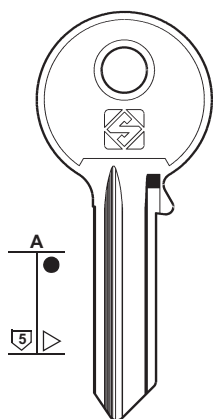

RM1A RM1RA

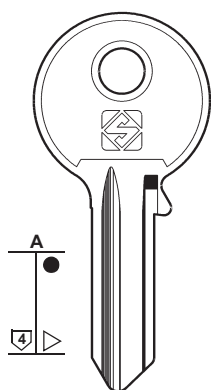

RM2A RM2RA

REX

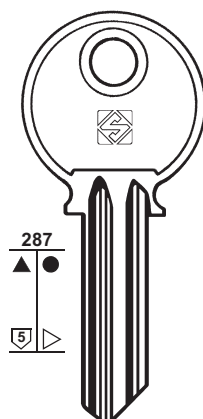

RX2

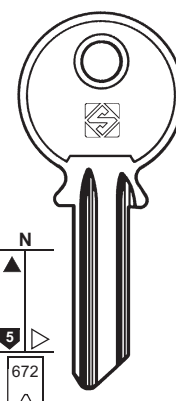

RX1
K ... 1-50



146

PER / FOR

RGM (E)

RICOUARD (F)

COUILLET
DECAYEUX
KIFERM
LAS
PASSY
YVEL

RIGA (LV)

RIPA (E)

IFAM (95)

RIQUIER (F)

G.R. (89)

RIV (E)

UCEM (175)

RIVERS (AUS)

RJAZAN (RUS)

ROC (F)

YALE (193)

ROLEX (GR)

ZANETTI A. (200)

ROLL-A-DOOR (GB)

+ LEN-LOK (111)

+ L & F (117)

ROMA (I)

RONEO (E)

RONIS (147)

RONIS (F)

ANTAR

BLOCUS

CATOR

DAD

DC

DEBEURAIN

DELTA

DERLOCHE

DESPREZ

EMGE

EMHART

EQUIBATIR

FONTAINE

FORINDEX

GOLLOT

GUIDOTTI

JIP

LAPERCHE

LIONA-LIOX

MAFOR

MONDIAL

MOREAUX

NUMIDIA

PM

PROMECA

SESA

SOFRANQ

STREMLER

VEGA

+ EMKA (69)

+ LAS (110-111)

+ VACHETTE (181)

PER:
FOR:

RGM

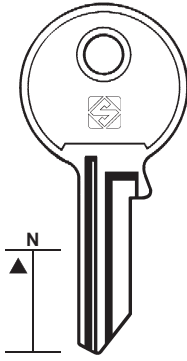

RGM1 RGM1R

RICOUARD

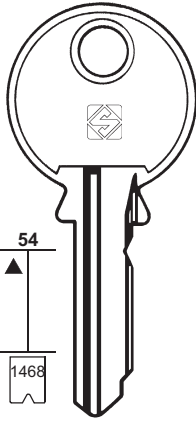

RIC1

K...726-950

COUILLET - DECAYEUX
KIFERM - LAS - PASSY - YVEL

RIGA

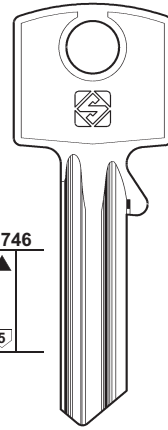

RGA1

RIVERS

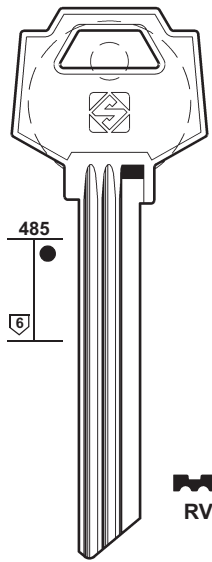

RV1

PER:
FOR:

RJAZAN

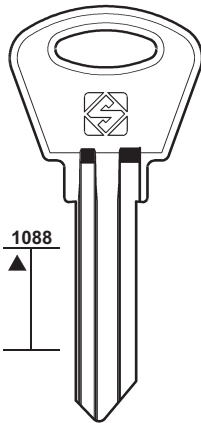

RZA1

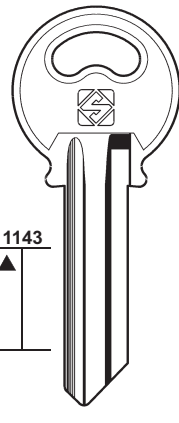

RZA2

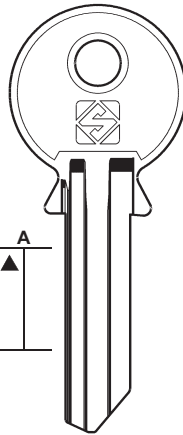

RZA3

ROLL-A-DOOR

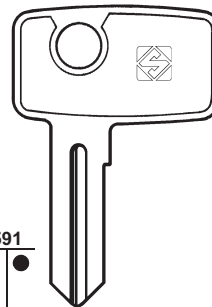

RD1

RD2
19...1-420

ROMA

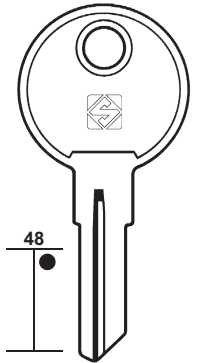

RA1

PER:
FOR:

RONIS

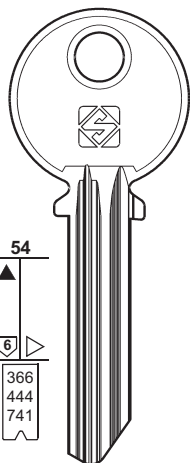

0-1-2-3-4-5-6-7-8-9

1-2-3-4-5-6-7-8-9

K...
KK...
N...
NN...
123456789

RO9 RO9R

ANTAR
LAPERCHE - SESA

UUL RO23 RO23R
FL
LAPERCHE

UUK RO25 RO25R
FK
LAPERCHE

UUM RO27 RO27R
FM
LAPERCHE

RO47 RO47R

RO41 DAD

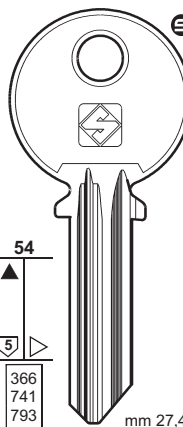

mm 27,4

MX... 1100-1699
A/Z... 12345678
... A/Z 12345678
... 123456789
... 9... 123456789
... J... 123456789

RO8

ANTAR
BLOCUS
CATOR

DC
DEBEURAIN
DELTA
DERLOCHE
DESPREZ
EMGE
EMHART
EQUIBATIR
FONTAINE
FORINDEX
GOLLOT
GUIDOTTI
JIP
LAPERCHE
LIONA-LIOX
MAFOR
MONDIAL
MOREAUX
NUMIDIA
PM
PROMECA
SESA
SOFRANQ
STREMLER
VEGA

RO8R
... 9 123456789
... N 123456789
9... 123456789

TTL RO22 RO22R
FL
LAPERCHE

TTK RO24 RO24R
FK
FONTAINE
LAPERCHE

TTM RO26
FM
LIONA-LIOX
LAPERCHE

RO37 RO37R

ET

RO43R

0-1-2-3-4-5-6-7-8-9

PER:
FOR:

RONIS

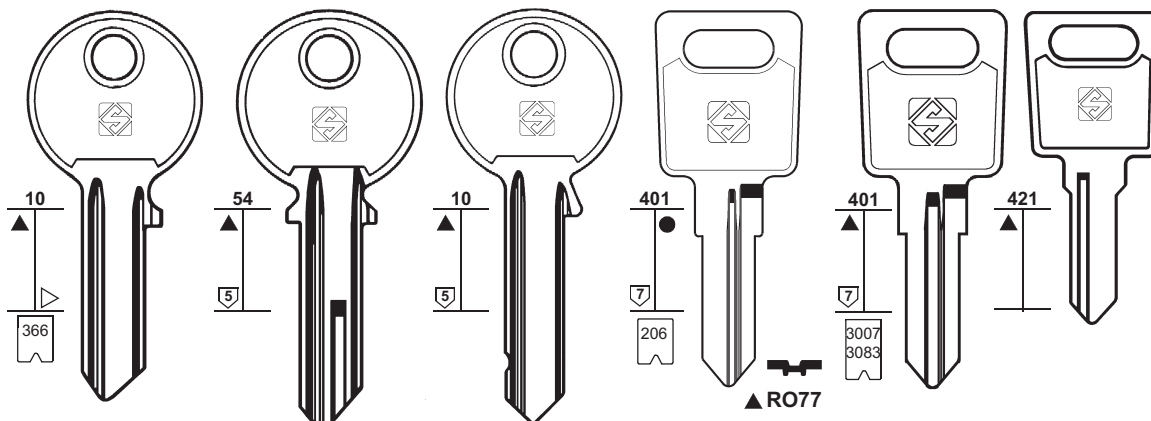

RO7 RO7R
... 0-1-2-3-4-5-6-7-8

RO13

RO14

RO67
NA ...
4001-5000

RO67R
ND ...
4001-5000

RO69
CC ... 1-2000

RO46R

ANTAR - GIMM
JIP - LAPERCHE
PM - SESA

SOLOR

CATOR

RO68
NC ...
4001-5000

RO68R
NB ...
4001-5000



147

PER / FOR

RONIS (F)

ANTAR
ARMOR
BURG
CATOR
DAV
EMHART
EMKA
FORINDEX
GIMM
JIP

KARDEX
LAPERCHE
MLM
NEMEF
P.J.
PM
RONEO
SANEL
SCHÄFER
SESA
SOLOR
STRAFOR
TAV
YAC

+ EMKA (69)
+ LAS (110-111)
+ VACHETTE (181)

PER:
FOR:

RONIS

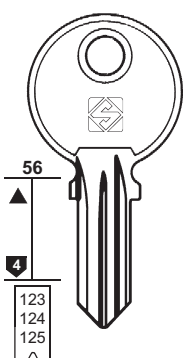

RO15 RO15R
A8 ... AA-DS
... 8 AB-ZZ
S ... 385-402

A9 ... AA-DS
... 9 AB-ZZ
S ... 403-420

P.J.

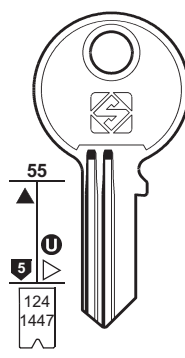

RO4
D ... 1-1000
S ... 1-106
T ... 1-106
... 11 1-200
A ... A 1-200
F ... 1-200
1F ... 1-21
TA ... 1-224
PS ... 1-30
GV ... 1-300
... F 1-500
... C 101-600
C ... 101-600
C ... 11111-44444
... A ... 12345
00 ... 12345
C ... 12345
T ... 313-380
... 11 501-700
A ... A 501-700

EMHART - MLM
NEMEF - SCHÄFER

RO45 RO48R

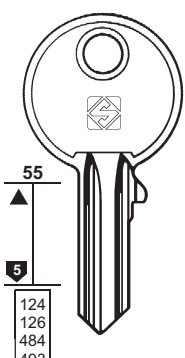

RO20
... E 12345
2 ... 12345
F ... 12345
S ... 247-279
T ... 247-279
1F ... 30-33
... 400-520
2 ... 400-520
... E 601-800
E ... 601-800

ARMOR - DAV - FORINDEX - KARDEX
RONEO - SANEL - STRAFOR - YAC

RO30
F ... 1-500
Z ... 1-900

RO38

RO42

RO50
B ... 1-20

RO20R
... A 12345
S ... 280-312
T ... 280-312
... A 400-520
... A 601-800
A ... 601-800

EMKA

RO30R

RO38R
H ... 1-1000

RO42R
... ZA1-ZZ3

PER:
FOR:

RONIS

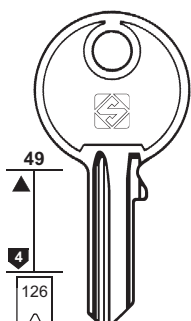

RO44 RO44R

RO34 RO34R
N ... 601-983 P ... 601-983

RO21 RO21R
... 601-983 M ... 601-983

BURG - STRAFOR - TAV

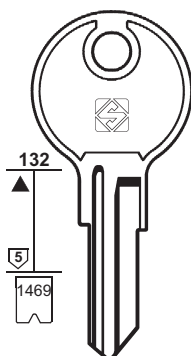

RO49
CH ... 101-751
GZ ... 101-751

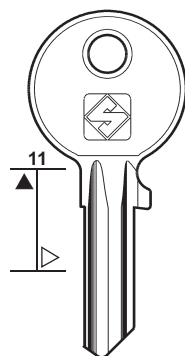

RO51

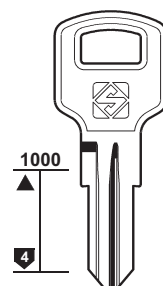

RO53R



148

PER / FOR

ROSSETTI (R)

ROSTEX (CZ)

LOB (114)

ROYAL (RC)

ABUS (8)

COLE (52)

GUARD (90)

VIRO (187)

YETI (198-199)

R.S.M. (GB)

P.C.

CORTELEZZI (140)

RUFFLER & DEITH (GB)

SIDLEEN (154)

RUFFLER & WALKER (GB)

SIDLEEN (154)

RUKA (D)

DOM (61)

VACHETTE (182)

RUKO (DK)

ASSA

DIFA

RUSSIA (RUS)

RUSSWIN (USA)

PER: ROSSETTI

FOR:

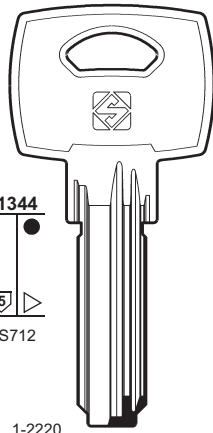

... 1-2220



RUKO

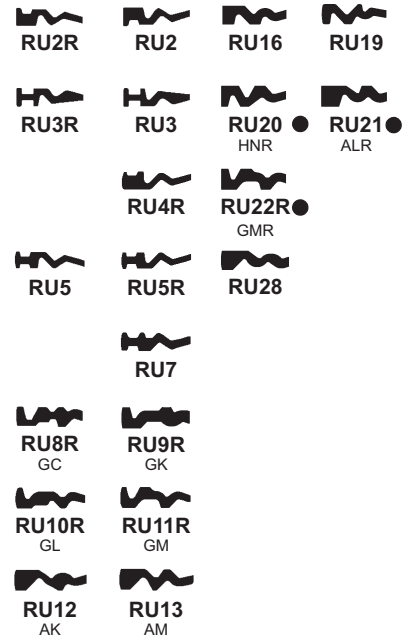

RU1
..... 1-2-3-4-5-6-7-8
..... 1-2-3-4-5-6-7-8-9
..... 1-2-3-4-5-6-7-8-9-0-A-B
..... 0-1-2-3-4-5-6-7-8-9-A-B-C-D-E-F-G-H-L-M
S..... 1-2-3-4-5-6-7-8-9

RU1R

DIFA

PER: RUKO

FOR:

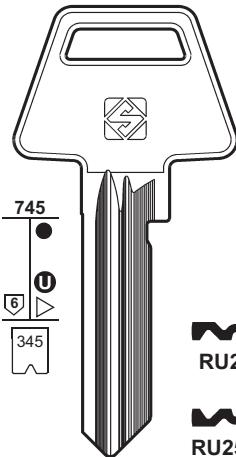

RU14
..... ABCDEFGHJ



ASSA

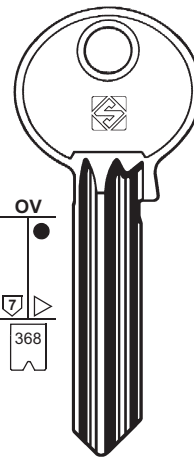

1-2-3-4-5-6-7-8-9-A-B-C

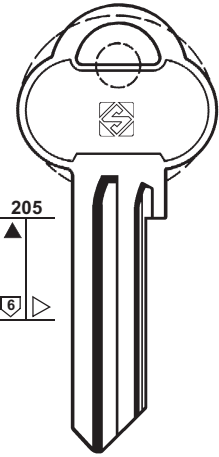

PER: RUSSIA

FOR:

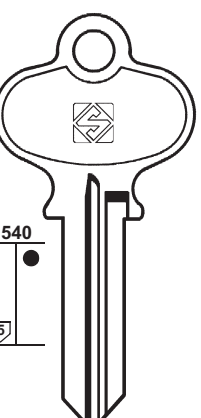
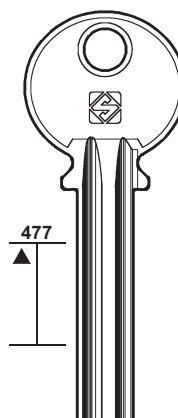
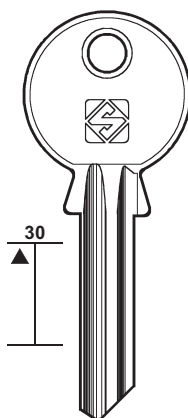
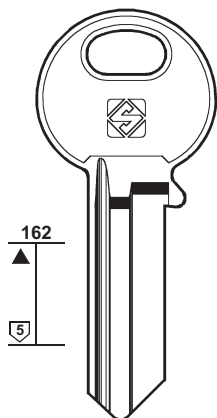

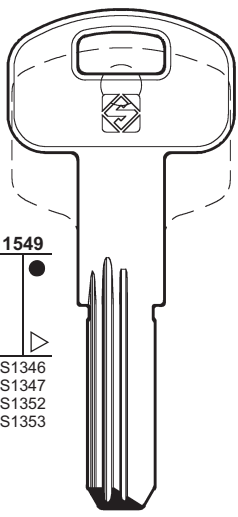
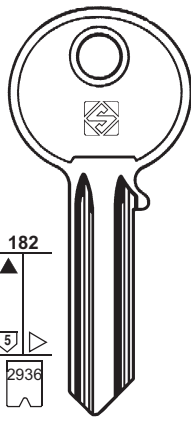
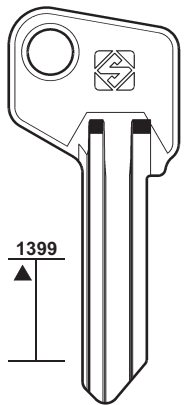
PER: FOR:	S-TECH	SABI	SAM
	 <p>1549</p> <p>S1346 S1347 S1352 S1353</p> <p>SCH1R</p>	 <p>182</p> <p>5</p> <p>2936</p> <p>..... 01234567</p> <p>SB1</p>	 <p>1399</p> <p>SMA1</p>

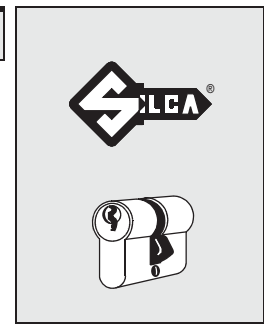

149

- PER / FOR
- S-TECH** (GB)
 - SAB** (I)
👁️ TAMPALINI (164)
 - SABI** (ET)
 - SAFE** (I)
 - SAM** (RUS)
 - SAMA** (F)
👁️ FTH (82)
 - SAMSONITE** (USA)
 - SANCHUN** (RC)
👁️ YETI (198-199)
 - SANEL** (F)
👁️ RONIS (147)
 - SANPEUR** (F)
👁️ VACHETTE (180)
 - SÄNTIS** (CH)
+ 👁️ CES (41-42)
 - SANTOS** (P)
👁️ OMEC (135)
👁️ P.C. (CORTELLEZZI) (139)
 - SANWA** (J)
 - SANY** (F)
👁️ ALPHA (15)

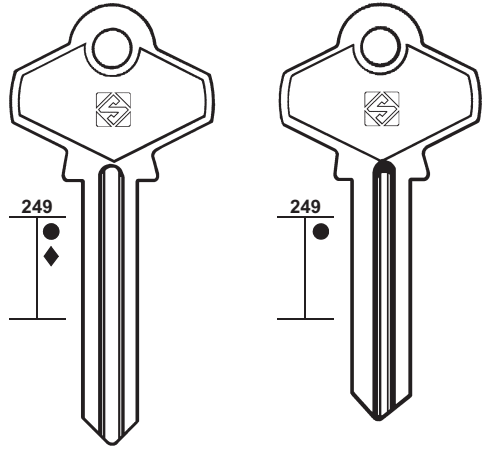
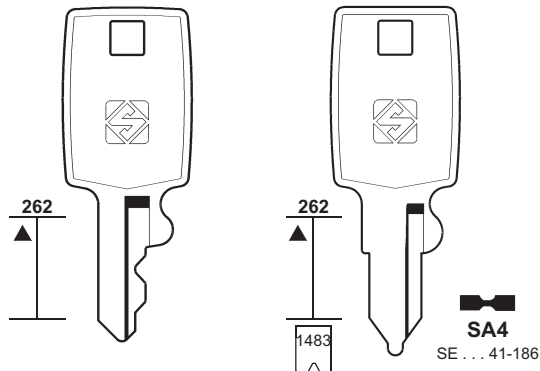
PER: FOR:	SAFE	SAMSONITE
	 <p>249</p> <p>SF1</p> <p>SF2</p>	 <p>262</p> <p>1483</p> <p>SA4 SE ... 41-186</p> <p>SA1 170 S SA1R</p> <p>SA2 70 S SA2R</p> <p>SA3 SE ... 315-396 SA3R SE ... 231-294</p> <p>SA5 SA5R</p>

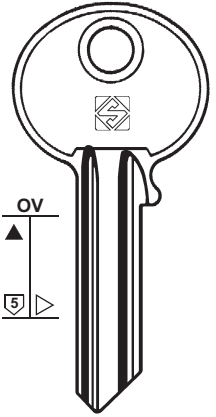
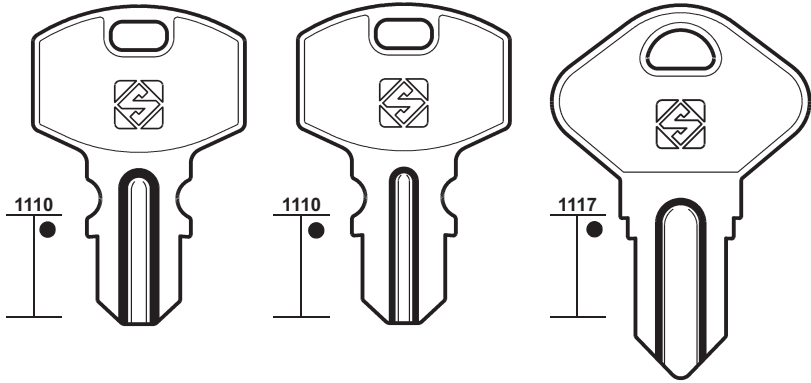
PER: FOR:	SÄNTIS	SANWA
	 <p>OV</p> <p>SAN1 SAN1R</p>	 <p>1110</p> <p>1110</p> <p>1117</p> <p>SNW1 SNW2 SNW3</p>



150

PER / FOR

SARATOV (RUS)

SARGENT (USA)
BRICARD
KESO
SHOWA

SARGENT & GREENLEAF (USA)
SLAYMAKER (157)

PER:
FOR:

SARATOV

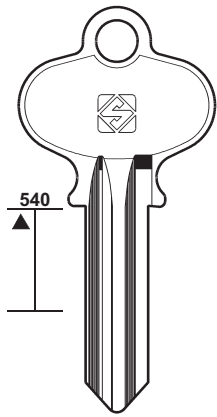

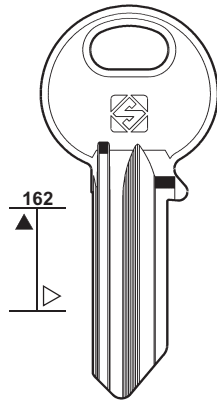

SRT1

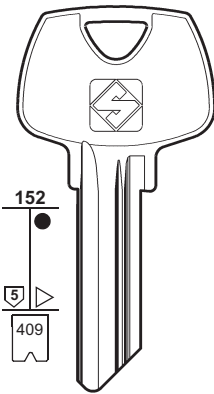

SRT2

SARGENT



 **SAR8**  **SAR17**

.....
1-2-3-4-5-6-7-8-9-0

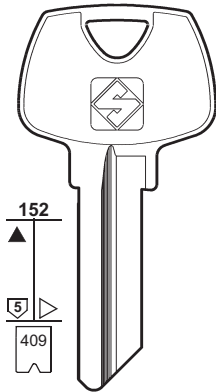

PER:
FOR:

SARGENT



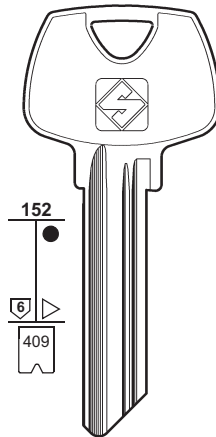



SAR17R
.....
1-2-3-4-5-6-7-8-9-0

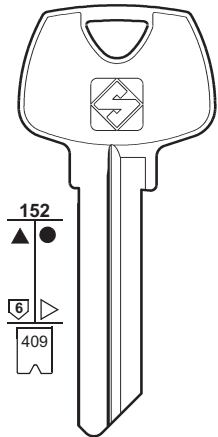

 **SAR21**  **SAR3**
.....
1-2-3-4-5-6-7-8-9-0



 **SAR22R**  **SAR3R**
.....
1-2-3-4-5-6-7-8-9-0
 **SAR21R**

PER:
FOR:

SARGENT

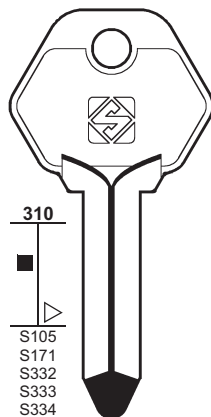

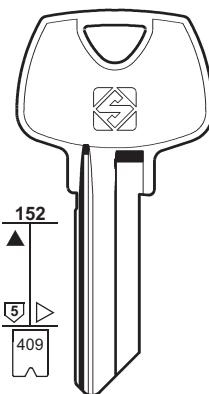

S105
S171
S332
S333
S334
S335
S336
S598
S599
S600
S601
 **KE4**

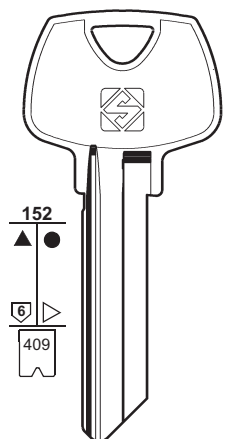

 **SAR1**
S
.....
1-2-3-4-5-6-7-8-9-0



 **SAR2**  **SAR4R**
S
.....
1-2-3-4-5-6-7-8-9-0

BRICARD - SHOWA

BRICARD - SHOWA

SATURN			SAVE	
OV ▲ 587	37 ▲ 5	1346 ● S1103	1047 ▲ ▶	1329 ▲ ▶
STU1	STU3	STU6R	SVE1R	SVE2R
1-2-3-4-5-6-7-8-9	mm 50	BASI		
GERA - VERA				



151

PER / FOR
SATURN (SLO) BASI GERA VERA
SAVE (CZ)
SAVIO (I) AGB (11) JVAL (102) P.C. (CORTELLEZZI) (139)
SCHÄFER (D) RONIS (147)
SCHÄRF (D) HUWIL (94)
SCHLAGE (I) (USA) BALDWIN EPO TACO

SCHLAGE				
249 ● ◆	583 ●	301 ▲ ▶ 401		301 ● ▶ 410
SH1 A	SH2 W	SH5R	SH27	T SH12R
EPO		A/Z 0123456789 A/Z-A/Z 0123456789		A/Z 0123456789 A/Z-A/Z 0123456789

SCHLAGE	
	<p>..... 0123456789 C </p> <p>..... A 0123456789 SH3</p> <p>S 100-27787 BALDWIN</p> <p>CE </p> <p>● SH17</p> <p>E </p> <p>● SH11</p> <p>EF </p> <p>▲ SH8</p> <p>F </p> <p>▲ SH9</p> <p>FG </p> <p>● SH18</p> <p>G </p> <p>▲ SH12</p>
301 ▲ ●	<p>H </p> <p>● SH13</p> <p>J </p> <p>▲ SH14</p> <p>K </p> <p>▲ SH15</p> <p>L </p> <p>SH16</p> <p>A/Z 0123456789</p> <p>A/Z-A/Z 0123456789</p>
410 ▶ 546	
TACO	



152

PER / FOR**SCHLAGE** (I) (USA)
BALDWIN
TACO**SCHLECHTENDAHL** (D)
CASI
HUTRA
NORDWEST**SCHLEGEL** (D)
DOM (61)**SCHÜCO** (D)
CISA (48)
KFV (105)**SCHULTZ** (D)
EURO LOCKS (71)**S & E** (F)
PICARDIE (141)**SE** (F)
G.R. (89)**SEA** (CH)
EZCURRA
HASLER
VIDMAR**SEAT** (I)
MICHEL
SICCAF**SECURE** (GB)
STA-LOCKPER:
FOR:

SCHLAGE

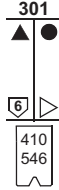
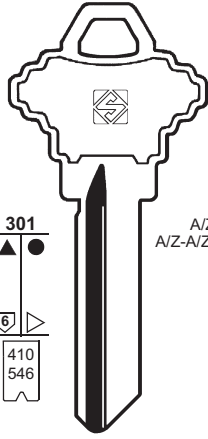
A/Z 0123456789
A/Z-A/Z 0123456789..... DG C
0123456789
SH5
BALDWINCE
SH23E
SH10EF
SH6F
SH7FG
SH24G
SH19A/Z 0123456789
A/Z-A/Z 0123456789

TACO

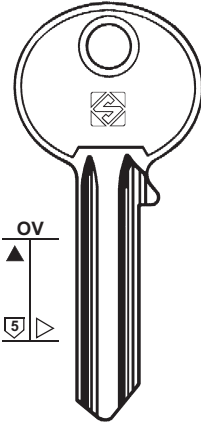
PER: **SCHLECHTENDAHL**
FOR:**SEA****ST1**

CASI - HUTRA - NORDWEST

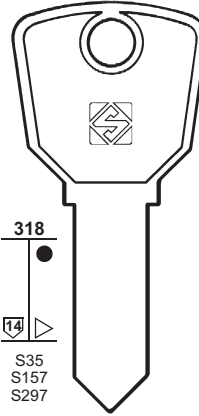
**SEB1**
20-23

EZCURRA - HASLER

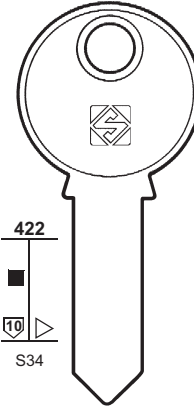
**SEB2**

EZCURRA - HASLER - VIDMAR

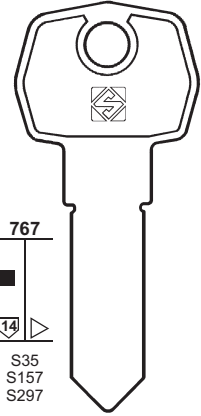
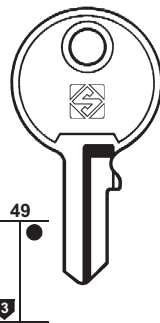
**SEB3**
20-23PER: **SEAT**
FOR:**SECURE****SEA4****SEA4R**

MICHEL - SICCAF

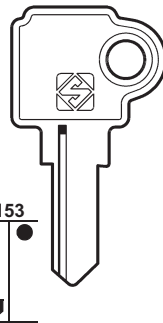
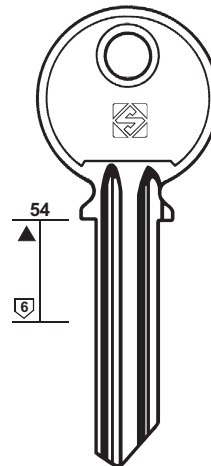
**SEA5** **SEA5R****SEA7** **SEA8****SC1**

STA-LOCK

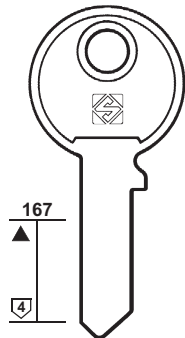
**SC2**

STA-LOCK

PER: **SECUREMME**
FOR:

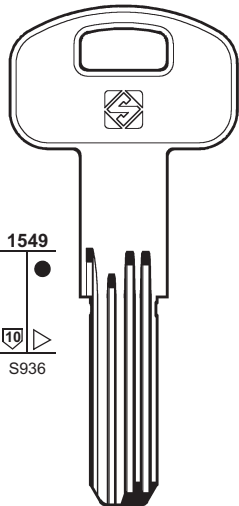

SCM1R
K2

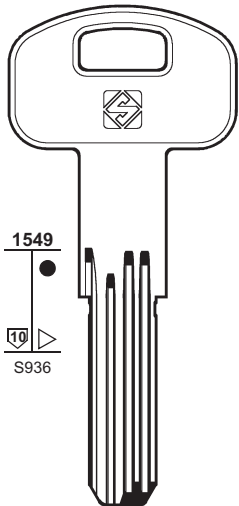

SCM2
K1

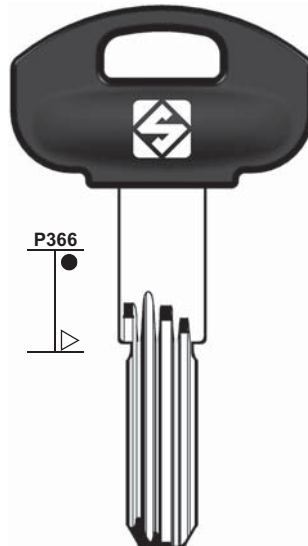

SCM3RP



153

PER / FOR
SECUREMME (I)
SECURITAL (I) KYR + ABUS (9) + FORT (81)
SEEBURG (USA) ILLINOIS (96)
SEGAL (USA) HUDSON READING
SEIM (F) KIFERM (106)
SELECT (F)
SELMACH (RUS)
SEMEL (F) JIS (99)
SEN (D) KFV (105)
SERITAL (I) PREFER (142)
SERRALLER (E) AGA (11)
SES (F) MELSMETAL (122)
SESA (F) RONIS (146-147)
SEZAN (RC) YETI (198-199)
SHANGHAI (PRC) CINA + CINA (48)

PER: **SECURITAL**
FOR:

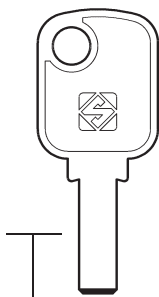

ZAMA
S39
S612
S760
S761
S1265
S1391
SCU1

KYR

SEGAL

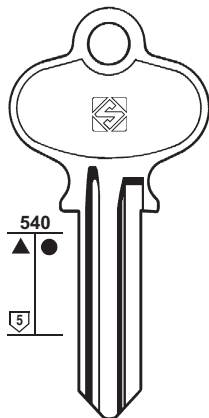

SL1
A
K9

HUDSON - READING

SELECT

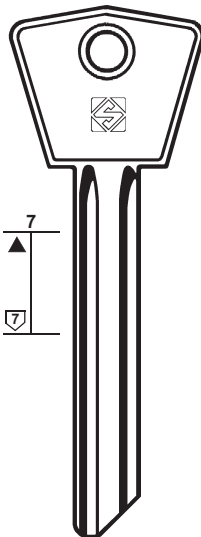

SE8

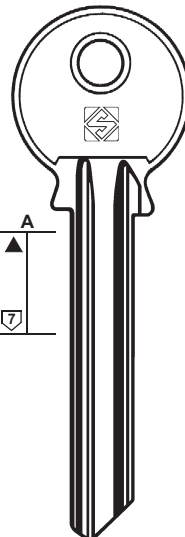

SE7

SE7R

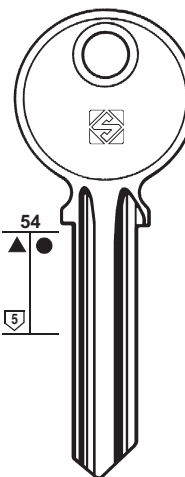

SE5

SE5R

PER: **SELECT**
FOR:

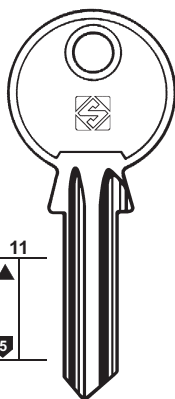

SE3

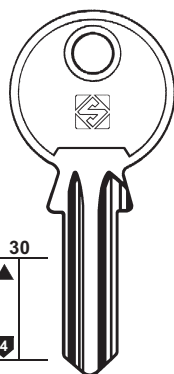

SE1

SE1R

SELMACH

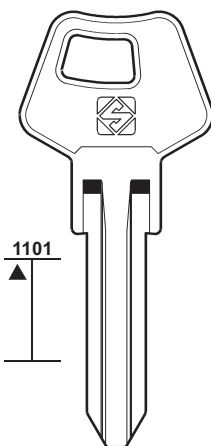

SEM1

SHANGHAI

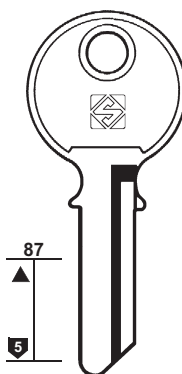

SG1

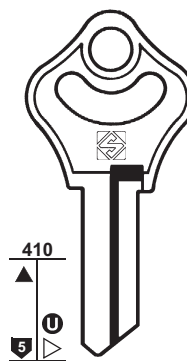

SG808

SG808R



CINA



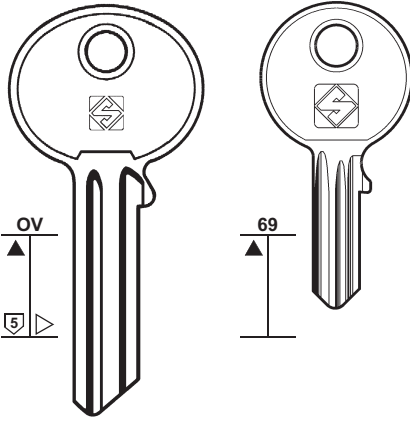
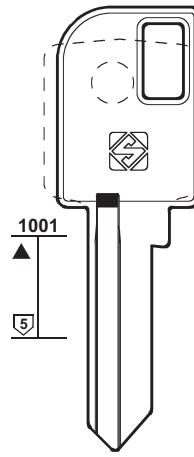
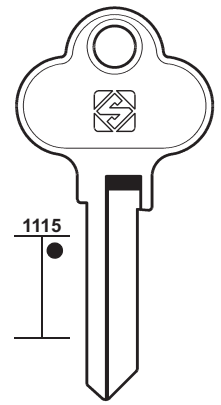
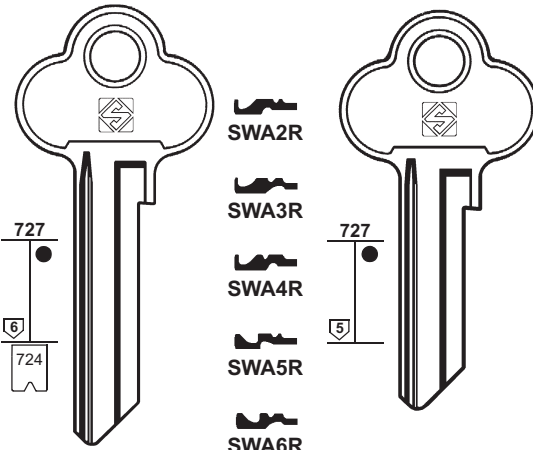

154

PER / FOR**SHAW** (GB)
+ HTV (93)**SHILUTE** (RUS)**SHOWA** (J)
+ SARGENT (150)**SIAM** (DZ)
+ CITY (51)
+ SIMECA (155)
+ ZENITH (201)**SICCAF** (I)
+ SEAT (152)**SICMA** (F)
+ ZENITH (201)**SIDLEEN** (GB)
BANHAM
EXCEL
REGENT
RUFFLER & DEITH
RUFFLER & WALKER**SIEBAU** (D)
+ CES (42)
+ TOK-WINKHAUS (170)**SIGENIA** (D)
+ POS (141)**SIGMA** (PL)**SIL** (P)PER:
FOR:**SHAW****SHW1****SHW2****SHILUTE****SHT1****SHOWA****SWA10**PER:
FOR:**SHOWA****SWA1****SWA2R****SWA3R****SWA4R****SWA5R****SWA6R****SWA7R****SWA8**

1-2-3-4-5-6-7-8-9

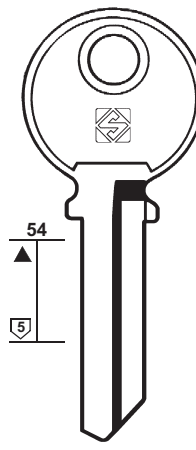
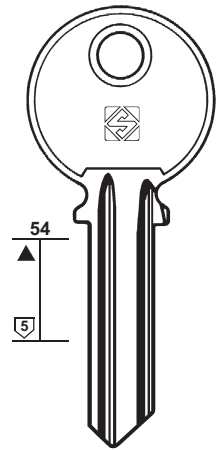
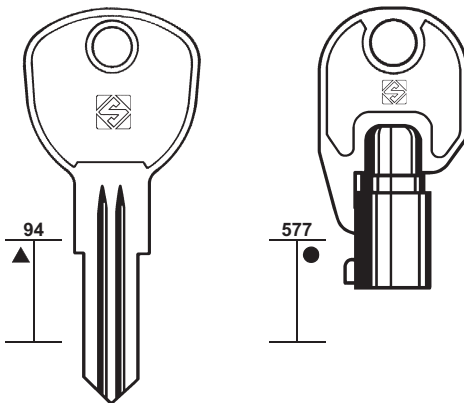
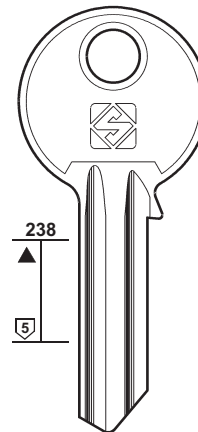
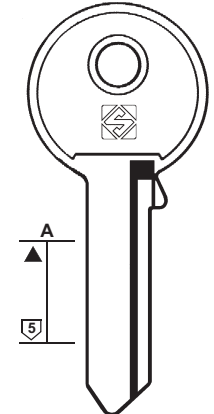
SIAM**SIA1R****SIDLEEN****SD1****EXCEL**PER:
FOR:**SIDLEEN****SD2****SD3T****BANHAM**
RUFFLER & DEITH
RUFFLER & WALKER
REGENT**SIGMA****SGM1****SIL****SIL1R**

PER: FOR:			SILCA			SILVANA		
580 S251	631 S251	1321	69	A				
PC12T	SLC1TP	SLC3T	SVN1	SVN2				
PC15T	SLC2TP							

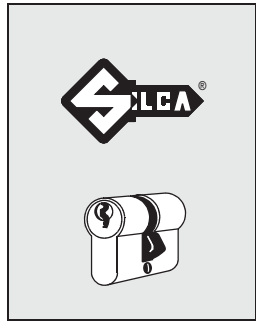

155

PER / FOR
SILCA (I)
 + P.C. CORTELLEZZI (140)
SILVANA (BR)
SIMATIC (CH)
 SIMECA (155)

PER: FOR:		SIMECA			
155	156	156	22	207	
SM2	SM3	SM4	SM5	SM6 Z1	SM8 Z3
SM10R	SM14R	SM9R	SM9 40	SM16	SM1R
GUTLER - KATE ORBA - SIAM - SIMATIC		JPM		CAB GIUSSANI	

SIMECA (CH)
 CAB
 GIUSSANI
 GUTLER
 JPM
 KATE
 ORBA
 SIAM
 SIMATIC
SINA (I)
 ZANI (200)
SINJET (D)
 DOM (61)
SIS (I)
 ZENITH

PER: FOR:		SIMECA				SIS (I)	
56	85	85	56	37			
SM15	SM13	SM12	SM11	SS1	SS1R	SS3	SS3R
				SS10 UTZ			
							ZENITH



156

PER / FOR

SIS (I)
FEL
LÄSBOLAGET
PICARDIE

SIS (P)

SISO (I)
+ CAS-CISMA (40)
+ EVERGOOD (71)
+ OJMAR (134)

SJL (RUS)

SKILLMAN (USA)
CORBIN (54)

PER:
FOR:

SIS (I)

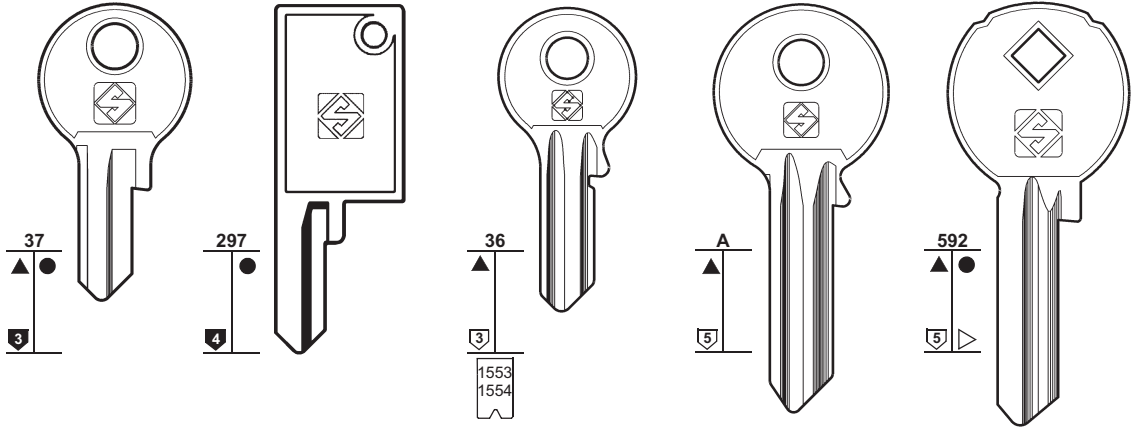

SS9

SS6

SS14 SS14R
... 7654321

SS12

SS7 ●SS7R



FEL



PICARDIE

LÄSBOLAGET

PER:
FOR:

SIS (I)

SIS (P)

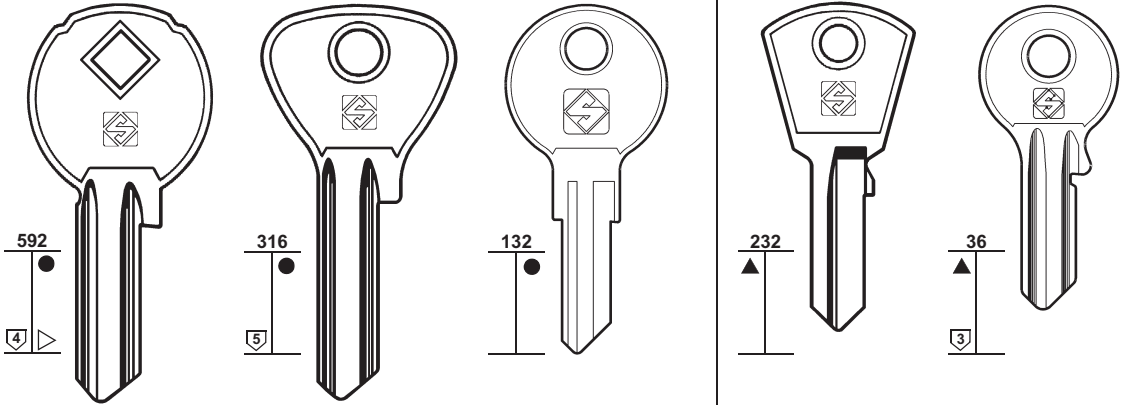

SS8

SS4

SS13

SSP1

SSP5

SSP1R

PER:
FOR:

SIS (P)

SISO

SJL

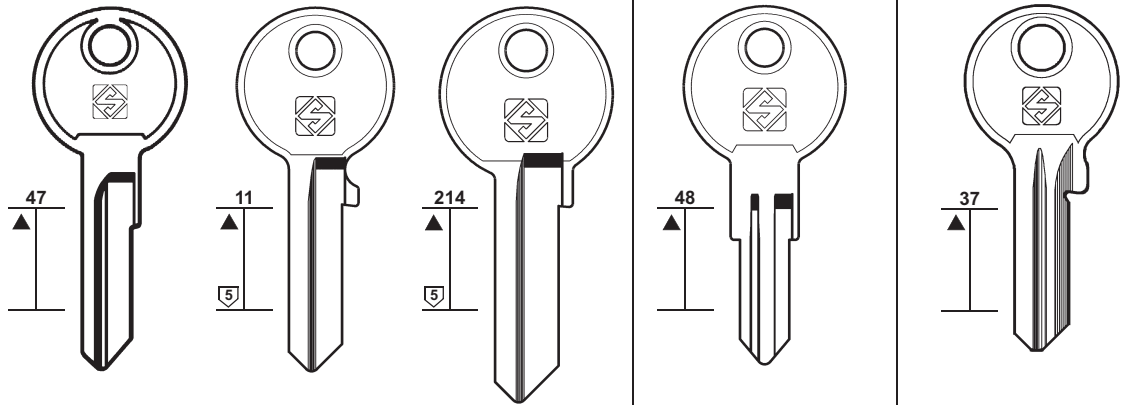

SSP2

SSP4 SSP4R

SSP6

SSO1 SSO2

SJ1R



PER: FOR:	SKMZ	SLAYMAKER	SOBINCO	
	 CKM1	 SY1	 SN3R	 SN4R
		SARGENT & GREENLEAF		

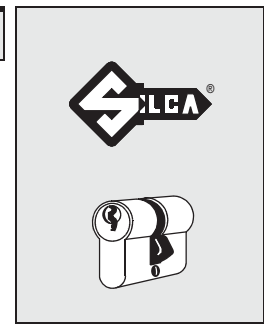

157

PER / FOR
SKMZ (UA)
SLAYMAKER (USA) SARGENT & GREENLEAF
SOBINCO (B) + SOFI-SONAFI (157)
SOF (F) GLOBE (87-88)
SOFER (P)
SOFI-SONAFI (P) CHAVO SOBINCO
SOFRANQ (F) RONIS (146)

PER: FOR:	SOBINCO	SOFER	SOFI-SONAFI

PER: FOR:	SOFI-SONAFI				
					SOBINCO



158

PER / FOR

SOLER (E)

SOLID (RSA)

👁️ **CES** (42)

SOLOR (F)

👁️ **RONIS** (147)

SONICO (BG)

SOPRANO (BR)

SOLER

PER:
FOR:

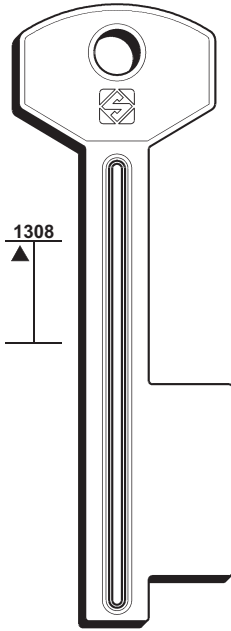

SLR1

SONICO

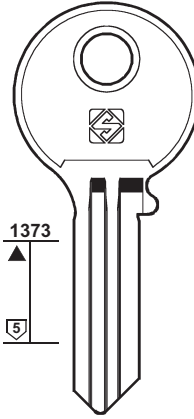

SNC1



SNC2



SNC2R

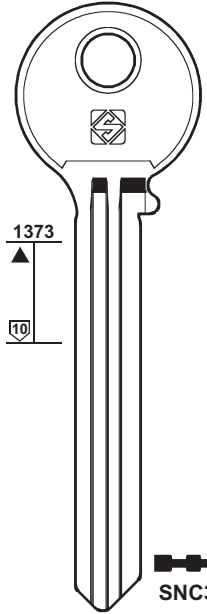

SNC3

SOPRANO

PER:
FOR:

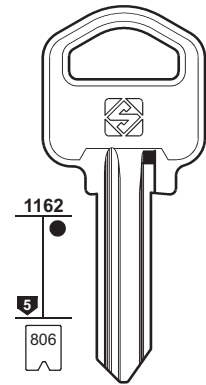

SOP1

.....
1-2-3-4-5-6-7-8-9

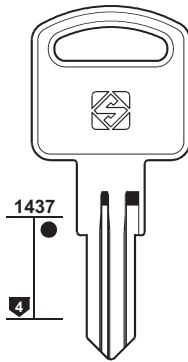

SOP2

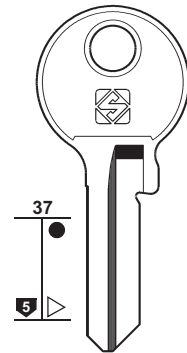

SOP10

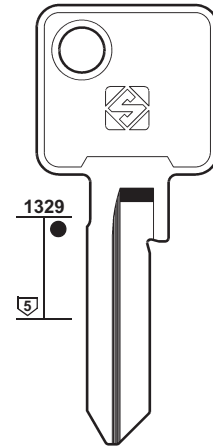

SOP11

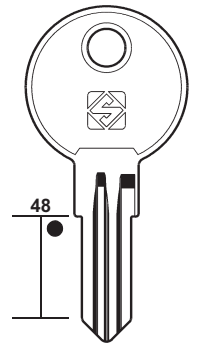

SOP12

SOPRANO

PER:
FOR:

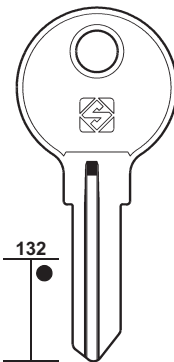

SOP15R

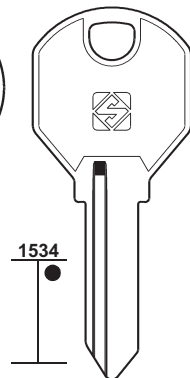

SOP13R

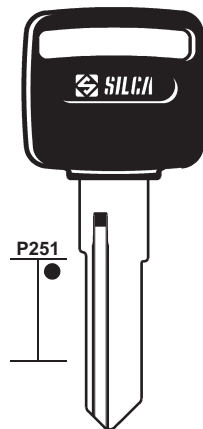

SOP14RP

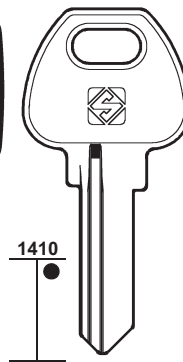

SOP16R

.....
1-2-3-4-5

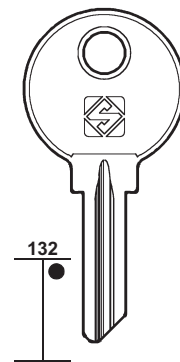

SOP17R

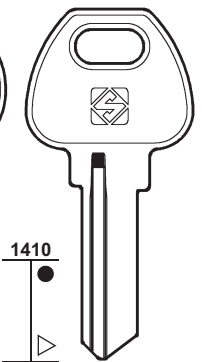

SOP18R

PER:
FOR:

SOS

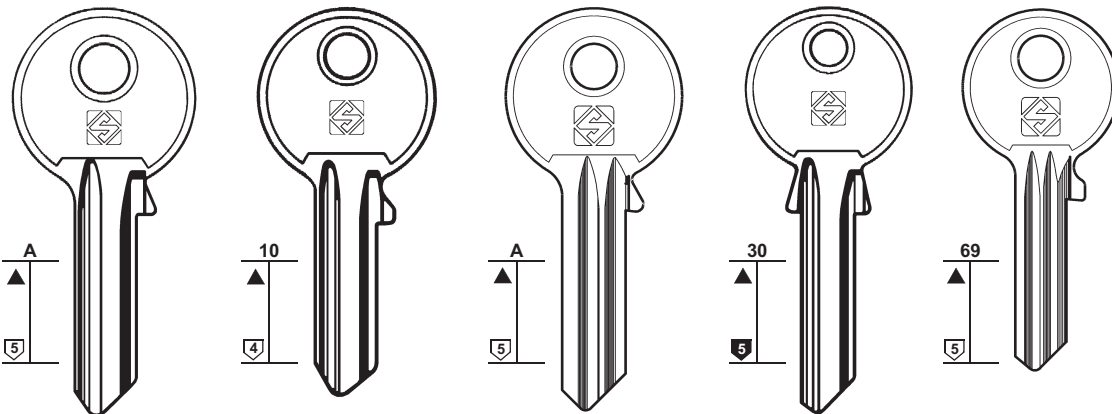

159

PER / FOR

SOS (F)

- + CITY (51)
- + GABON (84)
- + MING-TAY (126)
- + TESA (165)
- + YALE (195)

SOUTHCO (GB)

- YALE (194)

SP (F)

- FTH (81)
- MUL.T.LOCK (131)

SPEEDAL (I)

- CES (43)

SPIDER (IL)

- CAVERS
- CODKEY

SQUIRE & SONS (GB)

SS (D)

- CES (42)

STA-LOCK (GB)

- SECURE (152)

PER:
FOR:

SOS

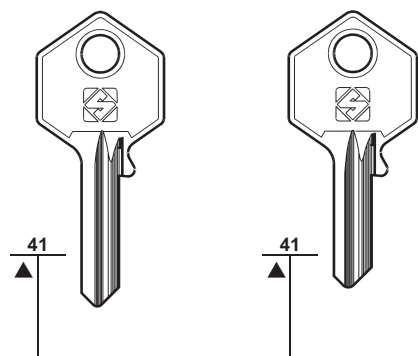

SPIDER

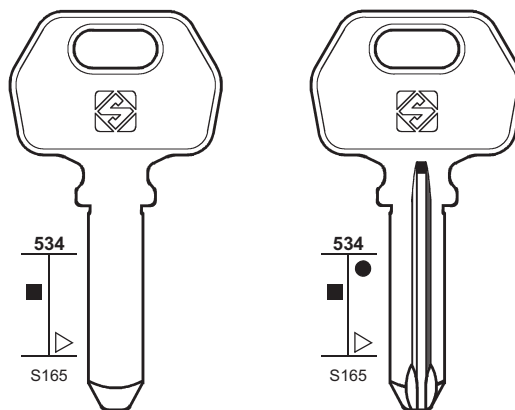

PER:
FOR:

SQUIRE & SONS

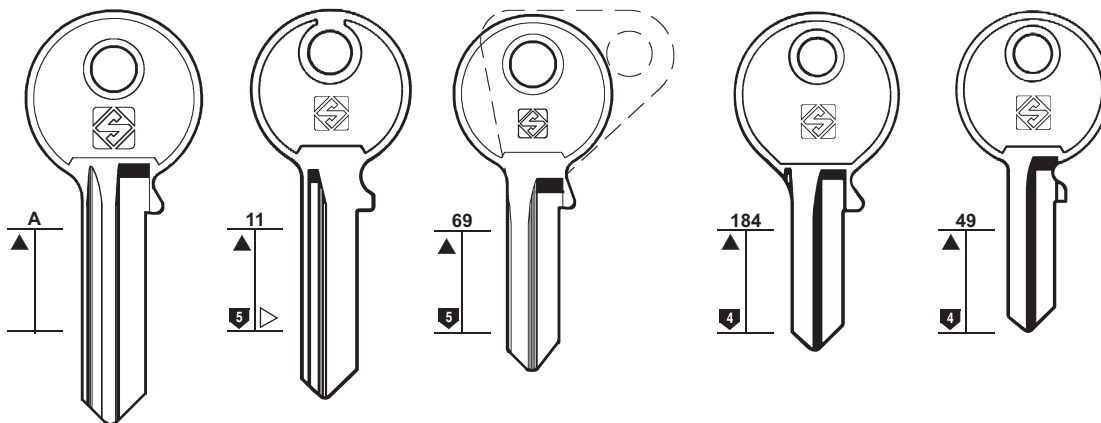



160

PER / FOR

STAM (BR)

STANDARD (D)

CISA (48)

STANOFDRO (PRC)

PER:
FOR:

STAM

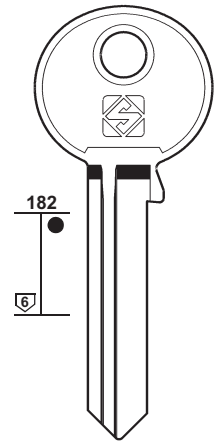
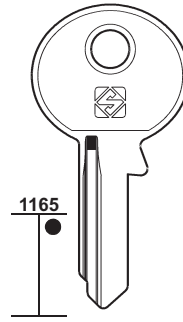
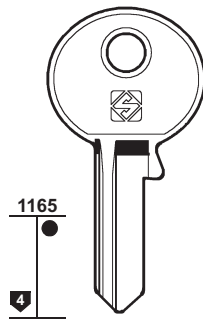
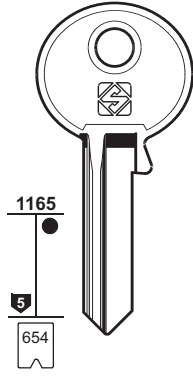

SAM14

SAM9R

SAM1 SAM1R ①
..... 1-2-3-4-5-6-7-8

SAM15R

SAM13 SAM13R

SAM4

PER:
FOR:

STAM

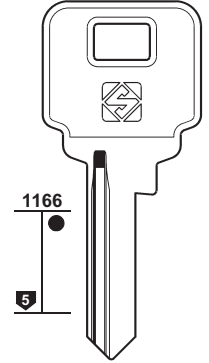
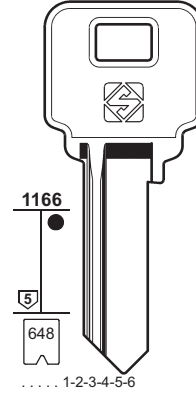
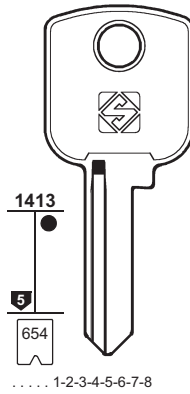
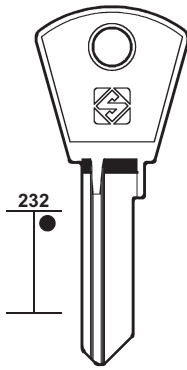

SAM16R

SAM2

SAM3R

SAM6

SAM12R

SAM2R

PER:
FOR:

STAM

STANOFDRO

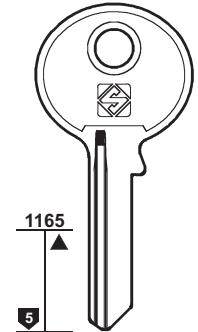
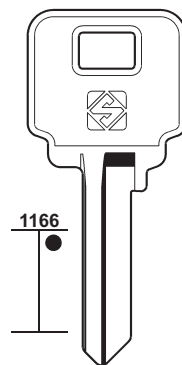
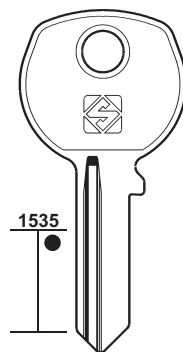
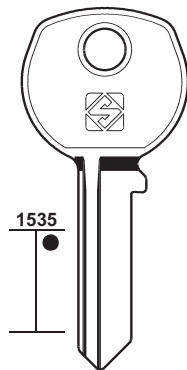

SAM10

SAM11R

SAM8

SFD1R

PER:
FOR:

STAR

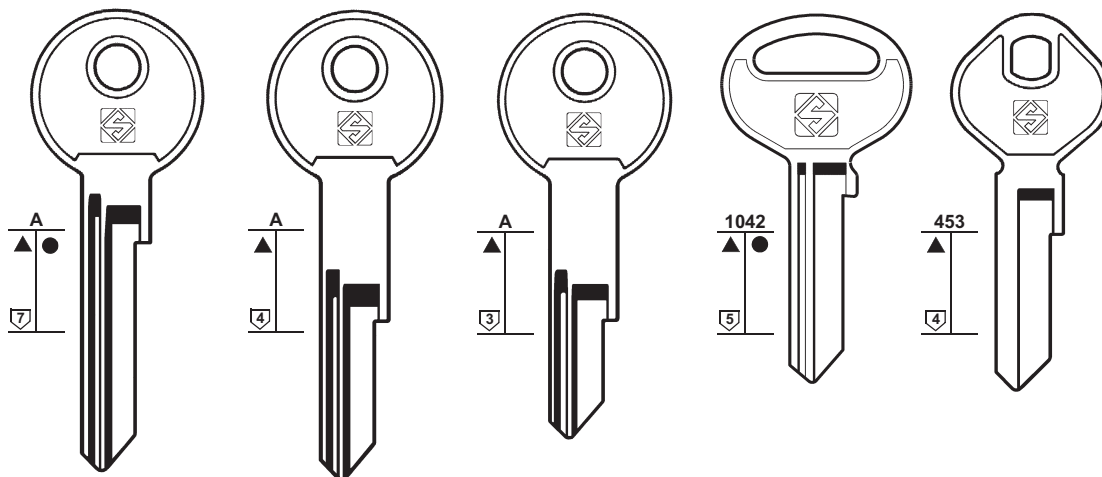

 ●



161

PER / FOR

STAR (J)
GS
IJ
TEC
+ ISEO (97)

STARLET (D)
GERA

STARRY (NL)

STEELCASE (USA)
 CHICAGO (45)
 HUWIL (94)

STEIGA (D)
 DOM (62)

STIQAM (TN)
 CAS-CISMA (40)

PER:
FOR:

STAR

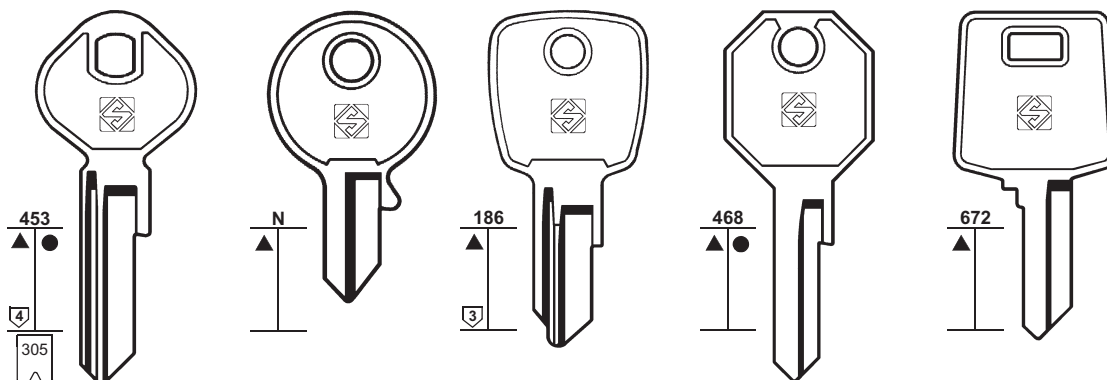

K... 1-1600



PER:
FOR:

STARLET

STARRY

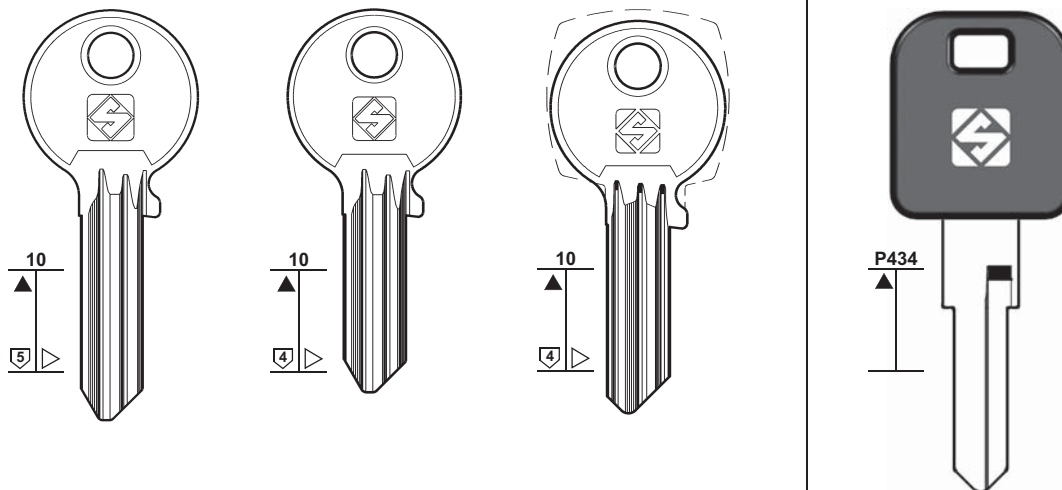

GERA





162

PER / FOR

STORWALL (GB)

STRAFOR (GB)

- HUWIL (94)
- LAS (110)
- RONIS (147)

STREBOR (GB)

STREMLER (F)

- BRICARD (35)
- CAS-CISMA (40)
- CORBIN (53)
- RONIS (146)

STS (E)

ALSO
ARFE
BTV

- + ARFE (17)
- + DOM (61-62-63)
- + ELCA (68)
- + PICARDIE (141)
- + TESA (166)

STUBLINA (SCG)

STUMPF (D)

- + OJMAR (134)

PER: **STORWALL**

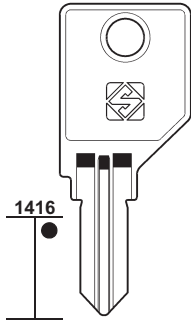

SWL1



PER: **STREBOR**

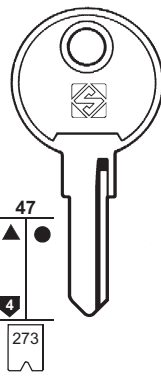

STR5
F... 402-480

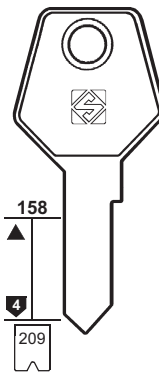

STR3
S... 1-70

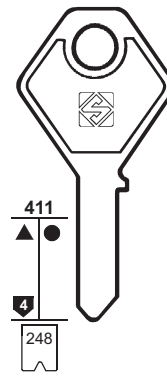

STR4
RR... 502-579

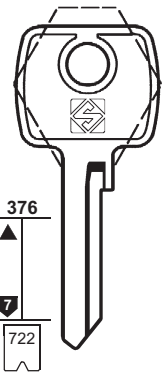

STR6
MT... 1-989



PER:
FOR:

STS

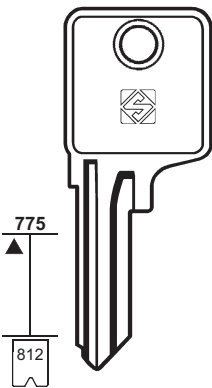

STS1 STS1R
.....
(625) 0-1-2-3-4-5



ALSO

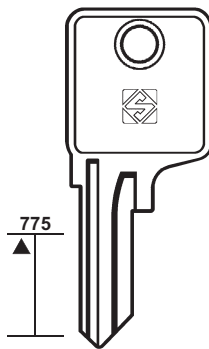

STS2 STS2R

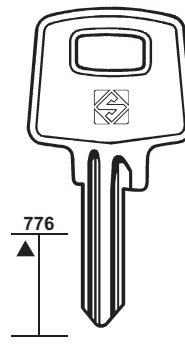

STS3



BTV

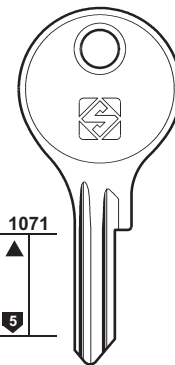

STS4

ARFE

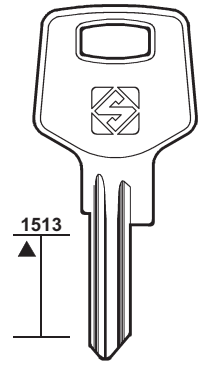

STS11

PER:
FOR:

STS

STUBLINA

STUMPF

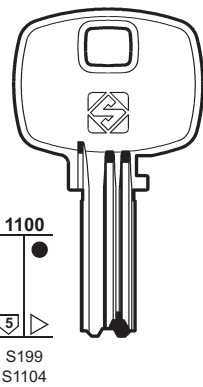

S199
S1104

STS5

K... 5001-8030

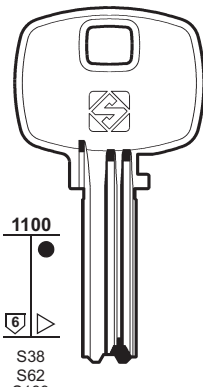

S38
S62
S199
S436
S1104

STS6 ⊕

J
K

P... 5001-8030
K... 5001-8030

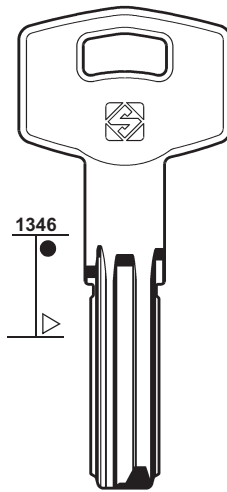

STS9

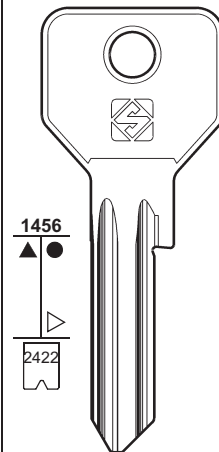

STN1 STN1R
..... 12345678

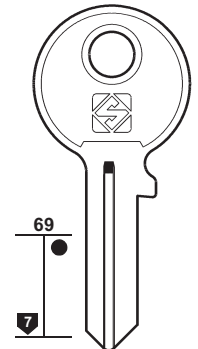

STF1 STF1R



PER: **STUV**
FOR:

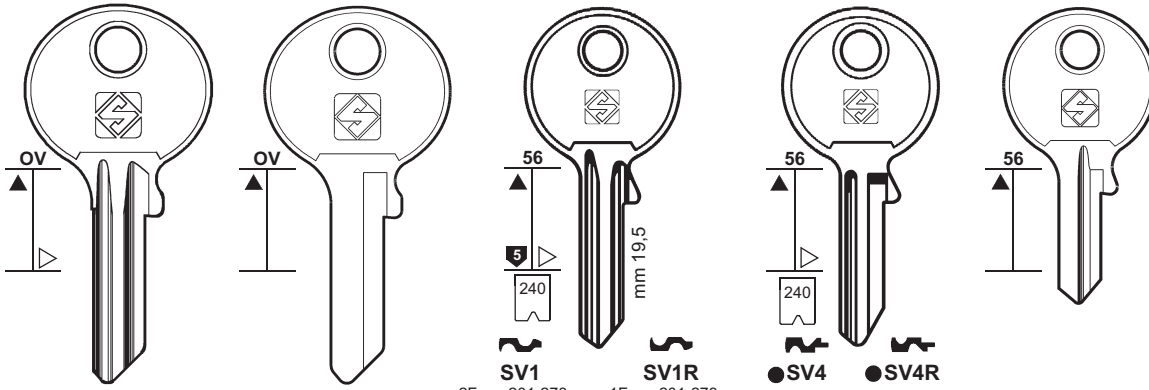

SV1 2F ... 201-278
1F ... Z 201-278
1F ... X 201-278

SV1R 1F ... 201-278
1F ... Z 201-278
1F ... X 201-278

SV4 ●
SV4R ●

SV5R ●

SV3 **SV3R**

SV7

SV2R

SV2

SV8 **SV8R**

2F ... 201-278
1F ... Z 201-278
1F ... X 201-278

SV6R



MLM - DOM



163

PER: **SUNSUI** **SUPER** **SUREX**
FOR:

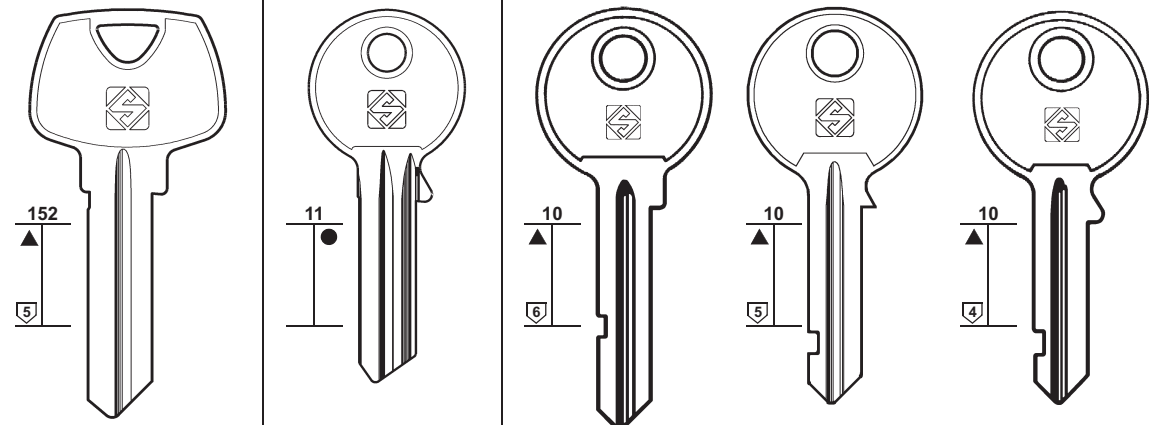

SU1R

SPU1R

SR8

SR7

SR6

PER: **SUREX**
FOR:

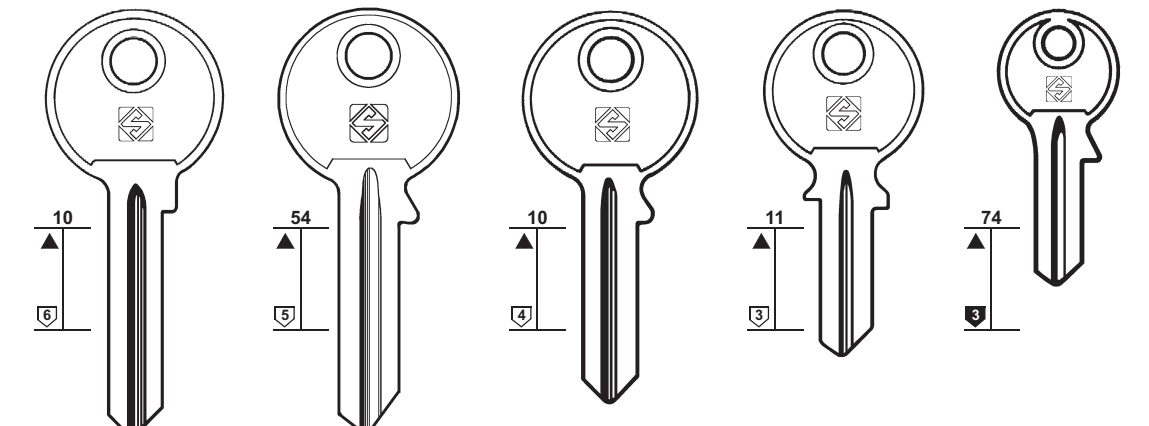

SR10R

SR4

SR11R

SR2

SR2R

SR9R



ATLAS

ATLAS - EUROP
MATTEY

PER / FOR

STUV (D)
DOM
MLM
+ CES (41-42)
+ DOM (62)
+ MLM (127)

STV (I)
 OMIV (136)

SUF (F)
 FTH (82)

SUKI (J)
 FLORA (81)

SUL (I)
 CORBIN (53)
 P.C. CORTELLEZZI (140)

SUNSUI (RC)

SUPER (RC)

SUREX (F)
ATLAS
EUROP
MATTEY
+ GABON (84)
+ YALE (194)

SURFINOR (F)
 FICHET (80)

SUYOKA (J)
 AGA (10)

SWAN (I)
 YETI (198-199)



164

PER / FOR

SWEDA (I)

- + PREFER (143)
- + PRIM (144)

SWISSTAC (D)

- + DOM (61)

TACO (USA)

- + SCHLAGE (151-152)

TALLIN (EST)

TAMPALINI (I)

- BALLY
- K+K
- SAB
- TF

- + MORI E. (128)

TANLOCKS (RSA)

- + LÄSBOLAGET (111)

TARONI (I)

PER: **SWEDA**

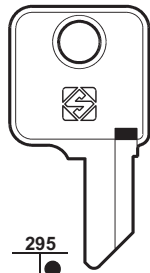

295

SW3

L



PER: **TALLIN**

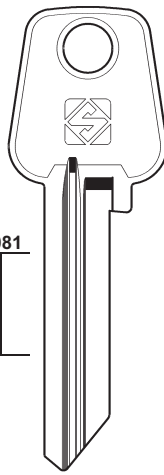

1081

BLT1R

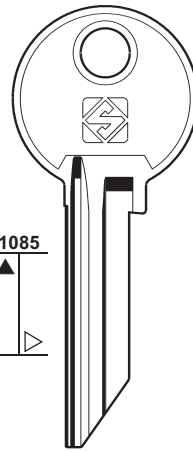

1085

TLN1

PER: **TAMPALINI**

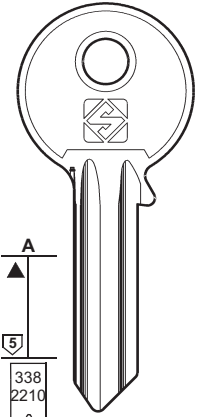

A

5

338
2210

TP1 TP1R

- 123456
- 12345

BALLY - K+K - SAB - TF

PER: **TAMPALINI**

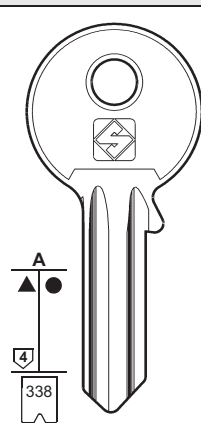

A

4

338

TP2 TP2R

- 1-2-3-4-5-6

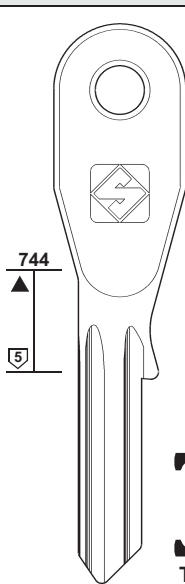

744

5

TP3

TP3R

PER: **TARONI**

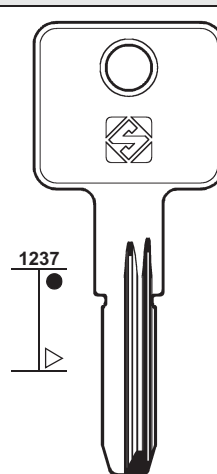

1237

TAR21

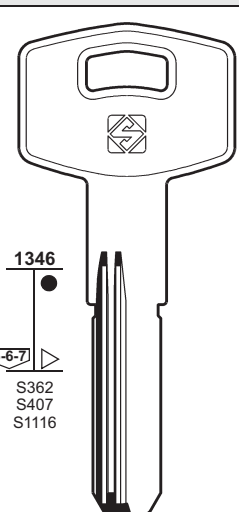

1346

- 5-6-7
- S362
- S407
- S1116

TAR16

TAR16R



PER: **TARONI**

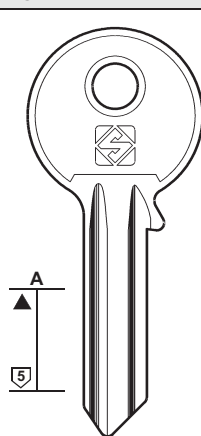

A

5

TAR4

TAR4R

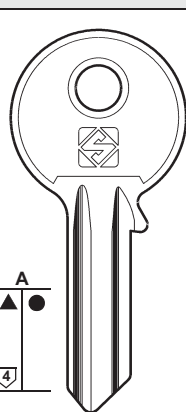

A

4

TAR5

TAR5R

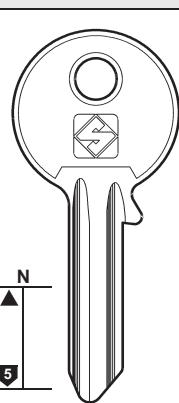

N

5

TAR8

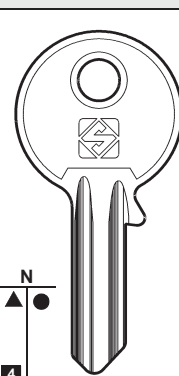

N

4

TAR3

TAR3R



74

4

TAR1

TAR1R

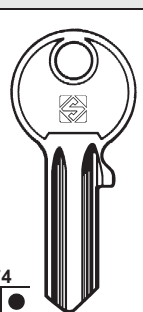







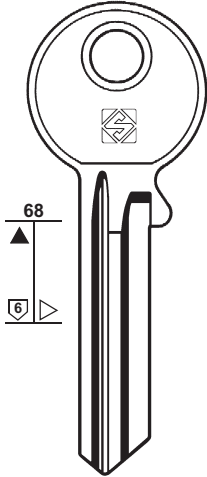

74

3

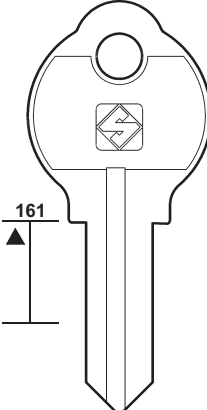
TAR2

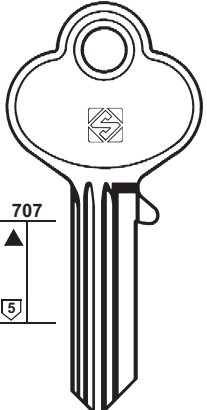
TAR2R

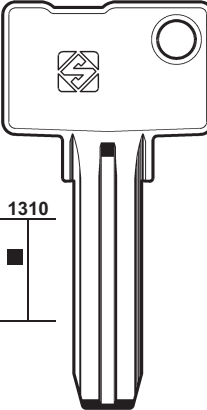



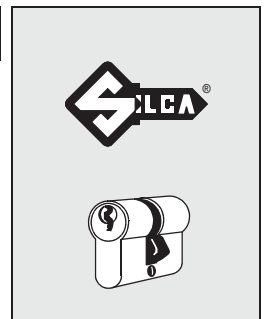





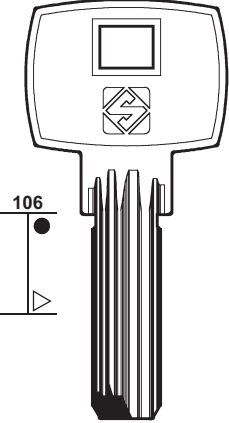

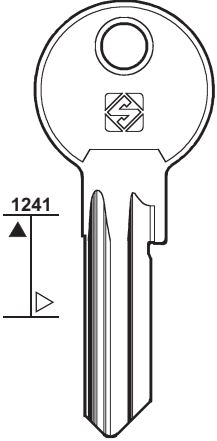
PER: FOR:	TARZEN	TAS	TAYLOR	TECSESA
	 <p>68 5</p>  <p>TKZN1</p>	 <p>161 5</p>  <p>TUS1 TUS1R</p>  <p>TUS2R</p> <p>BIBERING - TÜRSCHLOSS</p>	 <p>707 5</p>  <p>TY1</p>	 <p>1310 5</p>  <p>TEC1</p> 

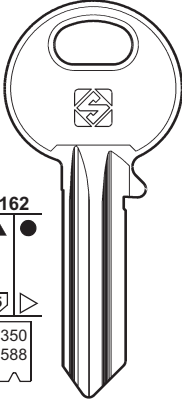

165

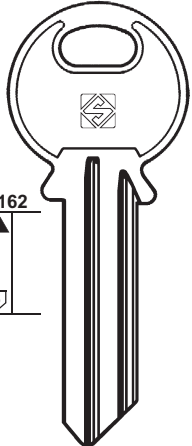
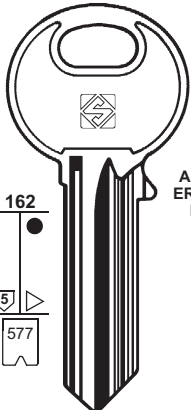
- PER / FOR
- TARZEN (RC)
 - TAS (D)
BIBERING
TÜRSCHLOSS
 - TAUB (E)
ZANETTI A. (200)
 - TAV (F)
RONIS (147)
 - TAYLOR (USA)
 - TEC (F)
STAR (161)
 - TECHNAL (D)
CAS-CISMA (40)
TESA (165)
 - TECNOR (F)
FICHET (80)
 - TECSESA (E)
 - TEEN HAAF (NL)
KIFERM (106)
 - TEGASI (GR)
 - TEICOCIL (P)
 - TEKA (S)
ASSA
ERICSSON
ERMEX
LM
+ ASSA (18)
 - TELFORD (GB)
L & F (116)
 - TEM (E)
IFAM (95)
 - TERCA (E)
AGA (11)
 - TESA (E)
ESAFE
GAINSBOROUGH
KAWE
METALUX
NINO
SOS
TECHNAL
+ ELCA (68)

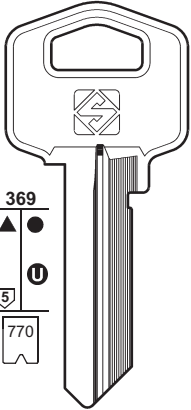
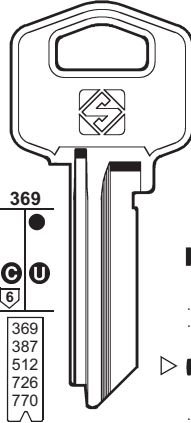
PER: FOR:	TEGASI	TEICOCIL	TEKA
	 <p>106 5</p>  <p>TGS1R</p> 	 <p>1241 5</p>  <p>TCL1</p>	 <p>162 5 350 588</p>  <p>ASS6 ● ASS6R 20201 20301 0-1-2-3-4-5-6-7-8-9-A-B-C D-0-1-2-3-4-5-6-7-8-9-A-B-C ASSA</p>

PER: FOR:	TEKA	TESA
	 <p>162 5</p>  <p>162 5 577</p>  <p>TK1 20004 0123456789ABCEFG</p> <p>TK1R 20102 ASSA ERMEX LM</p> <p>TK2 21001</p> <p>TK3R 20802</p> <p>TK4R 21601</p> <p>TK4 21701</p> <p>TK2R 21101</p> <p>ERICSSON</p>	 <p>369 5 770</p>  <p>369 5 369 387 512 726 770</p>  <p>TE1 ▲ TE1R (TE-5) 0-9-8-7-6-5-4-3-2-1</p> <p>TE2 ESAFE (TE-5) 0987654321 0123456789 123456789 A/Z 123456789</p> <p>TE3 ▲ ● 123456789 A/Z 123456789</p> <p>TE6 ▲ 0987654321</p> <p>GAINSBOROUGH KAWE - METALUX NINO - SOS - TECHNAL</p>



166

PER / FOR**TESA (E)**KALE
STS
VIRO
+ ELCA (68)**TESIO (I)**

CORBIN (53)

TESTA (I)

CAS-CISMA (40)

TF (I)

TAMPALINI (164)

TH (D)H.R.S.
TRUMPF**THIRARD (F)****THÖMEE (I)**

CES (44)

THÖNE (D)

CORBIN (53)

TICINO (I)

BERTOLOTTI

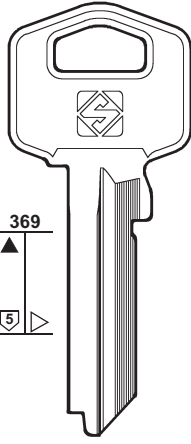
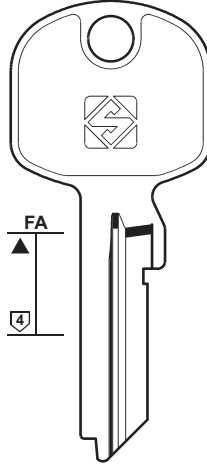
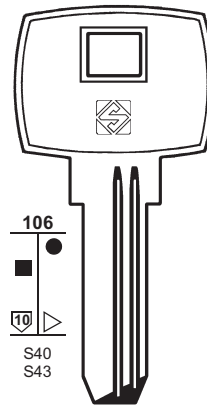
TIEFENTHAL (D) CISA (48)
 ELZETT (68)
 EMR (69)
 GTV (90)
 JOWIL (100)**TIFON (RC)**PER:
FOR:**TESA****TE2X****TE8XFA****TE4**

T-10

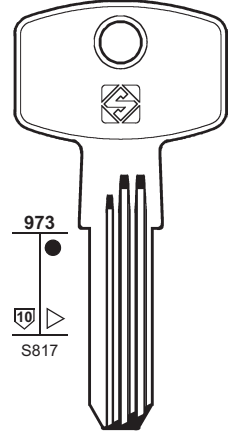
TE4R**STS****TE16**

T-10P

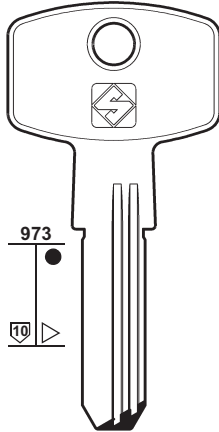
PER:
FOR:**TESA****EC5**

KALE - STS - VIRO

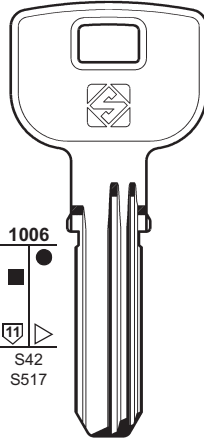
**TE5**

T-80

TE9

T80/SC

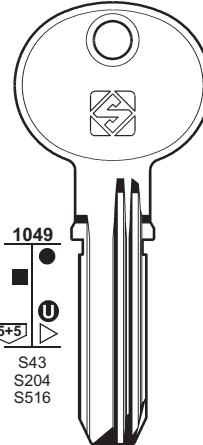
**STS****TE7**

T-60

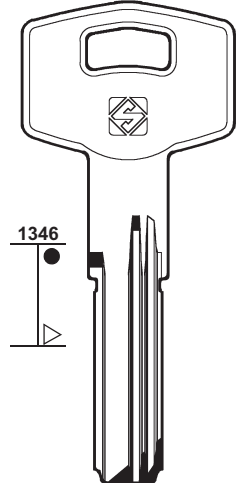
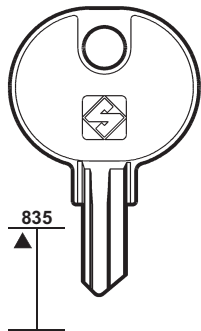
**STS****TE19**PER:
FOR:**TH****THIRARD****TICINO****TIFON****THA1**

H.R.S. - TRUMPF

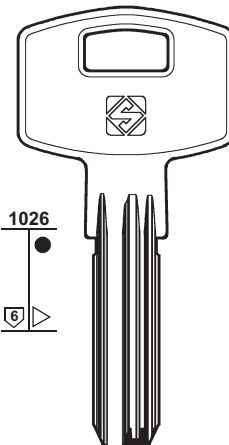
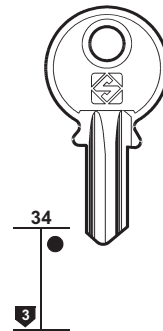
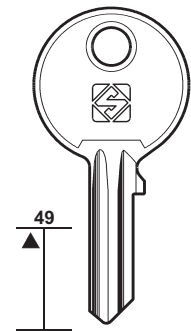
**THR1****TC1****TC1R****BERTOLOTTI****TFN1****TFN2**

PER: FOR:	TIGRIS	TIK	TITAN	



167

PER / FOR
TIGRIS (GB)
TIK (GB)
TITAN (SLO)
TITAN (SLO) EMKA GIUSSANI LAMA PICARDIE

PER: FOR:	TITAN			
			... 123456789	
				PICARDIE

PER: FOR:	TITAN			
	T100			EMKA GIUSSANI
				LAMA



168

PER / FOR

TITAN (SLO)
FTH
VACHETTE

TITUS (GB)
W.M.S. (192)

TM (D)
DOM (61)

TOKOZ (CZ)

TOK-TRELOCK (D)

TOK-WINKHAUS (D)
MASTER

PER:
FOR:

TITAN

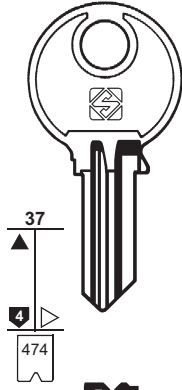

TN9
... 251-300

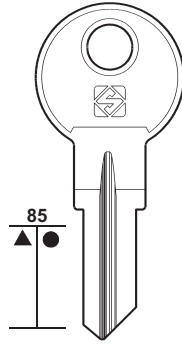

TN10

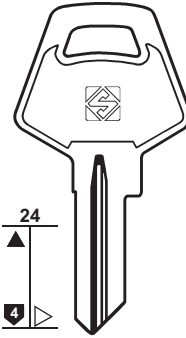

TN6R

TN11R

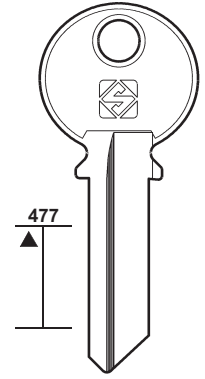

TN14

FTH
VACHETTE



PER:
FOR:

TITAN

TOKOZ

TOK-TRELOCK

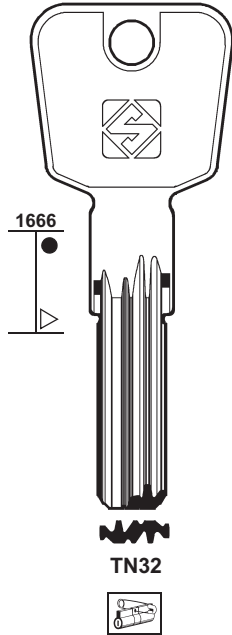

TN32

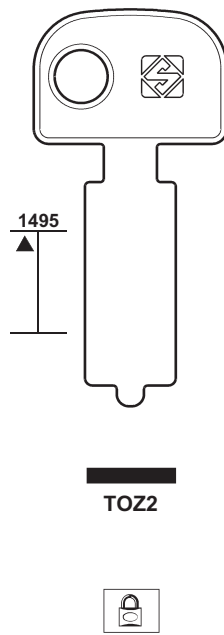

TO2

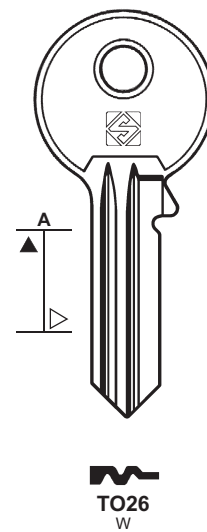

TO26
W

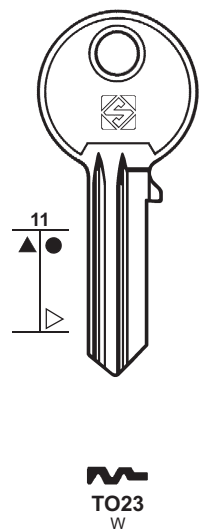

TO23
W

PER:
FOR:

TOK-TRELOCK

TOK-WINKHAUS

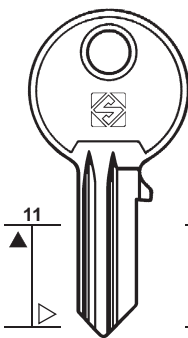

TO24
W

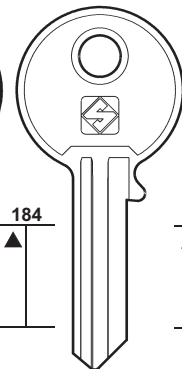

TO44

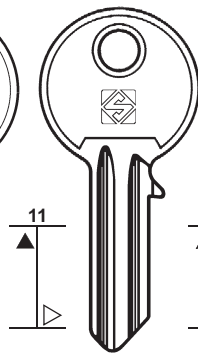

TO22

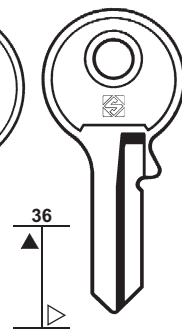

TO12

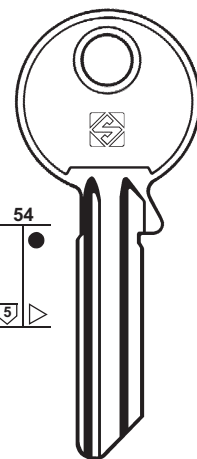

TO29

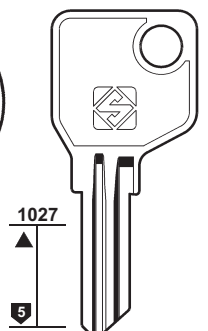

TO92R

TO66



PER:
FOR:

TOK-WINKHAUS

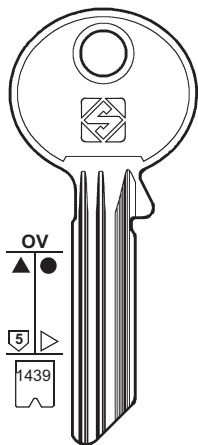

X.....
0-1-2-3-4-5-6

TO8X1	TO8RX1	TO8X7	TO8RX7	TO8X13 DISQUIN	TO8RX13
TO8X2	TO8RX2	TO8X8	TO8RX8	TO8X14	TO8RX14
TO8X3	TO8RX3	TO8X9	TO8RX9	TO8X15	TO8RX15
TO8X4	TO8RX4	TO8X10	TO8RX10	TO8X16	TO8RX16
TO8X5	TO8RX5	TO8X11	TO8RX11	TO8X17	TO8RX17
TO8X6	TO8RX6	TO8X12	TO8RX12	TO8X18	TO8RX18



169

PER / FOR

TOK-WINKHAUS (D)
DISQUIN

PER:
FOR:

TOK-WINKHAUS

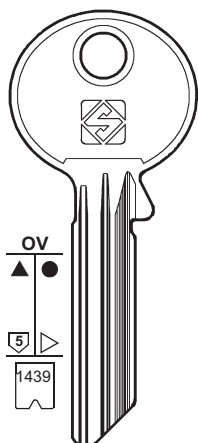

Y.....
0-1-2-3-4-5-6

TO9Y1	TO9RY1	TO9Y7	TO9RY7	TO9Y13	TO9RY13
TO9Y2	TO9RY2	TO9Y8	TO9RY8	TO9Y14	TO9RY14
TO9Y3	TO9RY3	TO9Y9	TO9RY9	TO9Y15	TO9RY15
TO9Y4	TO9RY4	TO9Y10	TO9RY10	TO9Y16	TO9RY16
TO9Y5	TO9RY5	TO9Y11	TO9RY11	TO9Y17	TO9RY17
TO9Y6	TO9RY6	TO9Y12	TO9RY12	TO9Y18	TO9RY18

PER:
FOR:

TOK-WINKHAUS

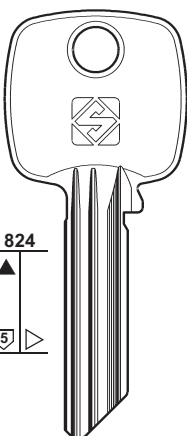

TO50X1	TO50X9	TO50RX9
TO50X2	TO50RX2	TO50X10
TO50X3	TO50X11	
TO50X4	TO50RX4	TO50X13
TO50X5	TO50RX5	TO50X14
TO50X6	TO50RX6	TO50X15
TO50X7	TO50RX7	TO50X17
TO50X8	TO50X18	

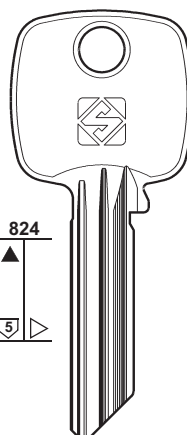

TO51Y1	TO51RY1
TO51Y2	TO51Y10
TO51Y3	TO51Y11
TO51Y5	TO51RY4
TO51Y6	TO51RY6
TO51Y7	TO51Y14
TO51Y8	
TO51Y9	



170

PER / FOR

TOK-WINKHAUS (D)
COMBA
EGSA
SIEBAU
TRELOCK
VACHETTE

PER:
FOR:

TOK-WINKHAUS

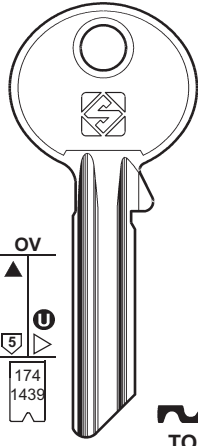

TO54-1	TO54-2	TO54-3	TO54-4
TO54-5	TO54-6	TO54-7	TO54-8
TO6 9	TO5 Z.....0123456	TO3 11	TO4 12
TO54-13	TO54-14	TO7 15	TO54-16
TO54-17	TO54-18	TO54-19	TO54-20
TO1	TO54-21	TO2 22	TO54-23
TO15	TO16	TO17 EGSA	TO75R
TO25R	TO28R	TO31R	TO82R

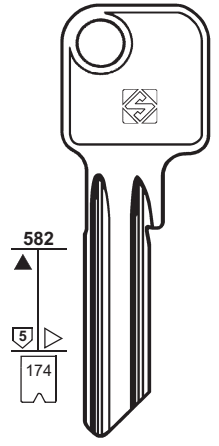
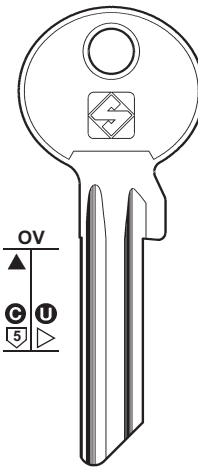

TO1X

TO10
P.....
0-1-2-3-4-5-6-7-8
TRELOCK

PER:
FOR:

TOK-WINKHAUS

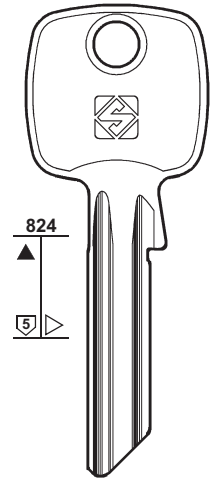
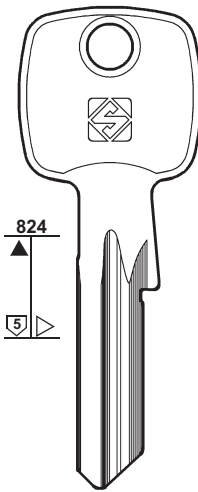
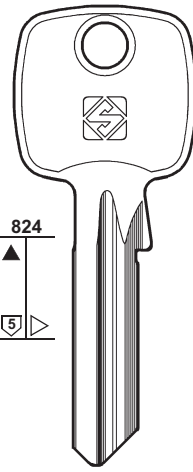
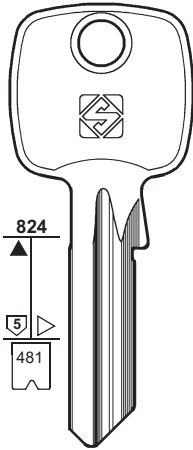
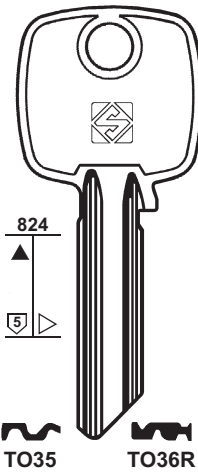

TO35

TO36R

TO41R

TO114RX
9.....X
012345678

TO124RX

TO120RX

TO125X

PER:
FOR:

TOK-WINKHAUS

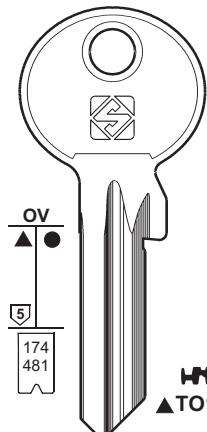
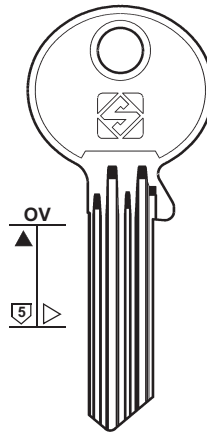
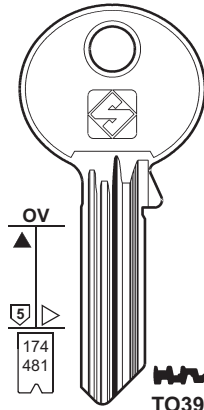
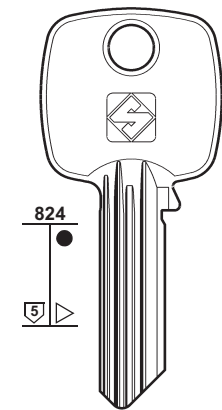

TO40

TO42R

TO30
9.....T
012345678

TO30R
9.....X
012345678

TO81R

TO30X
9.....T
012345678

TO108X

TO30RX
9.....X
012345678

TO34

PER:
FOR:

TOK-WINKHAUS

471

471

TO11

TO13

TO14 EGSA

TO21

TO27▲●
0123456789

TO18

TO19

TO20R

TO33

TO43

TO45■

TO52 ENAX

TO53 BFA1

TO55 FAABF

TO57 EHBA EKCP

TO58 EFAM EFWS

TO59 EWSB

TO60 BFA2

TO61 BFA3

TO64 BYNY1

TO65

TO91

TO106

TO107

TO111R

TO100

TO127

TO104

TO105

AZBE

AZBE

BIFFAR - FICHET



171

PER / FOR

TOK-WINKHAUS (D)
AZBE
BIFFAR
EFAM
EGSA
ENAX
FICHET

TOP (D)

ABUS
NOVA
+ 👁️ ABUS (6)
+ 👁️ WILKA (191)

TOR (I)

👁️ ZANETTI A. (200)

TORE (D)

👁️ CES (42)

TOUCH (GB)

TOVER (E)

MASTER
TROMER
+ 👁️ FTH (81)

TRABER (GB)

👁️ EURO LOCKS (71)

PER:
FOR:

TOP

TOUCH

10

OV

TOP1R

TOP1RX

ABUS - NOVA

47

47

47

3270

3270

3270

TOU1R

TOU2R

TOU3R

..... 12345

..... 12345

..... 12345

PER:
FOR:

TOVER

1213

1007

1007

1121

S49

S172

TV1

TV2

TV3

TV4

2F-35

2F-25

MASTER

TROMER



172

PER / FOR

TRAINS (RC)

TRAU (I)
PREFER

TRELOCK (D)
WASO

+ TOK-TRELOCK (168)
+ TOK-WINKHAUS (170)

TRI-CIRCLE (RC)
ABUS
ELEPHANT

+ DOUBLE CIRCLE (67)

PER:
FOR:

TRAINS

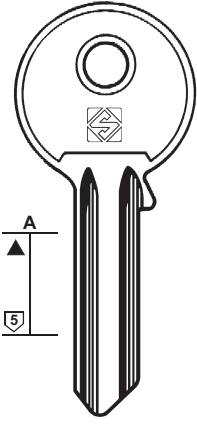

TS1

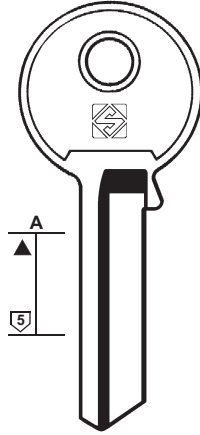

TS2

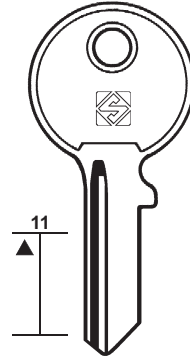

TS3

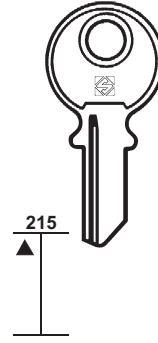

TS4

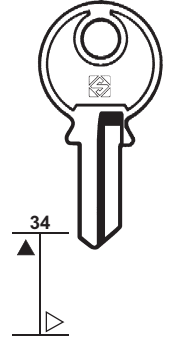

TS5



PER: **TRAU**
FOR:

TRELOCK

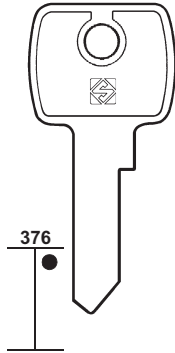

TRU1R

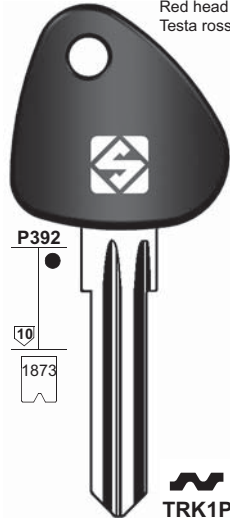

TRK1P

R6
0-1-2

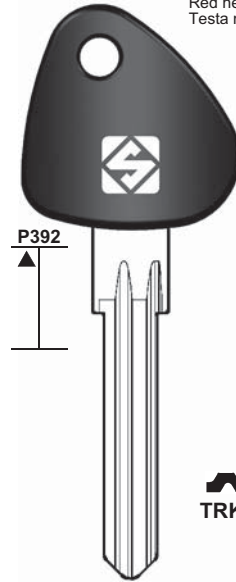

TRK7P

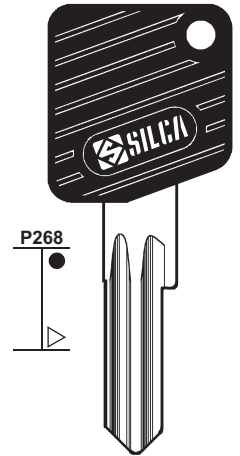
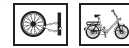
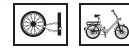

TRK4CP

WASO

PER:
FOR:

TRI-CIRCLE

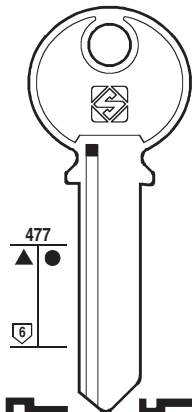

TL3 1C TL3R 1A

TL8 1D TL8R 1B

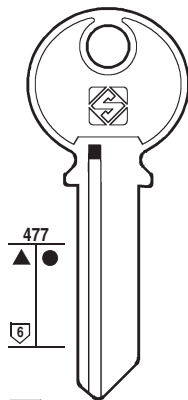

TL2 2D TL2R 2B

TL5 2C TL5R 2A

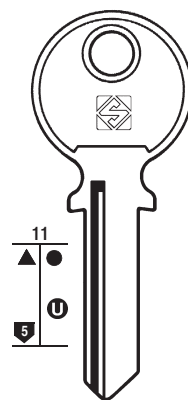

TL1 3C TL1R 3A

TL4 3D TL4R 3B

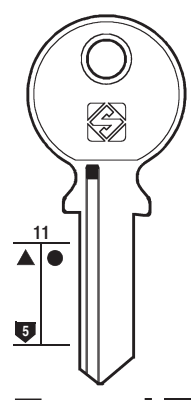

TL6 4C TL6R 4A

TL7 4D TL7R 4B



ABUS - ELEPHANT

PER:
FOR:

TRI-CIRCLE

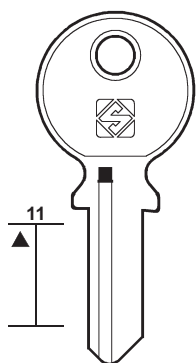

TL15

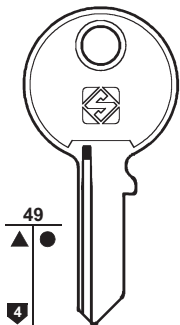

TL9
5C
YONGTAI

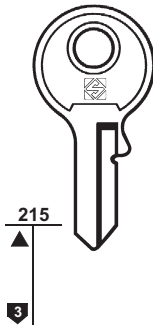

TL12R

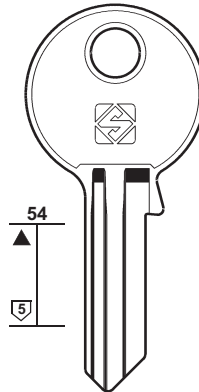

TL14

TL9R
5A

TL10
5D
TL10R
5B
ABUS - MARK



173

PER / FOR

TRI-CIRCLE (RC)
ABUS
MARK
YONGTAI
+ DOUBLE CIRCLE (67)

TRIO (N)
 TRIOVING (173)

TRIOVING (N)
TRIO

PER:
FOR:

TRI-CIRCLE

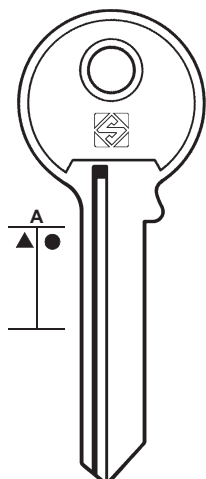

TL11 TL11R

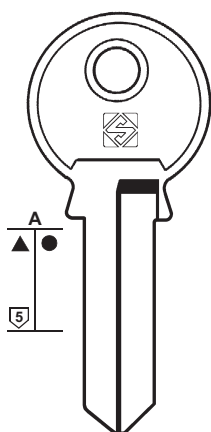

TL13



TRIOVING

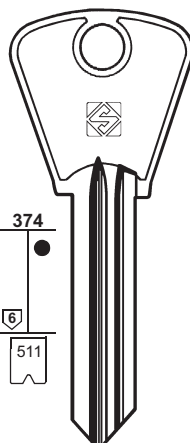

TR1

0-1-2-3-4-5-6-7-8-9-A

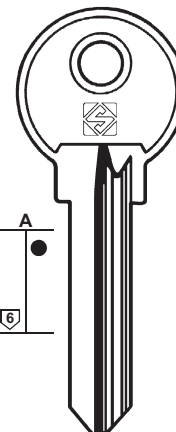

TR2

TRIO

PER:
FOR:

TRIOVING

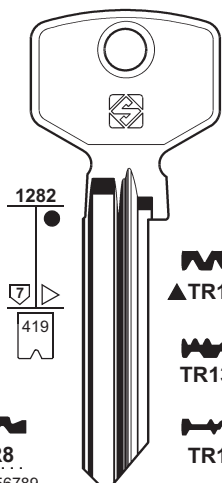

TR8
0123456789

TR9

TR10

TR16

TR13R

TR12

TR11R

TR10R

TR19R

TR18R

TR17R

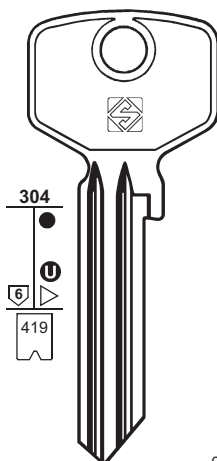

TR4

..... 0123456789
..... NK 1-18342
..... 1-26770
..... 30000-56769
..... ND 1-99999
D 1-13278
DCN -82660
..... 1-13278
..... 1-26770

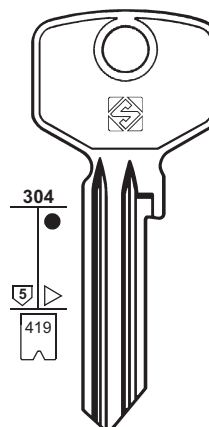

TR5

TR3

0-1-2-3-4-5-6-7-8-9



174

PER / FOR

TRIOVING (N)

TRI STAR (RC)

TRITON (D)

• CES (42)

• JOWIL (100)

TROMER (E)

• MCM (121)

• TOVER (171)

TRUMPF (D)

• TH (166)

TRYBA (A)

• EVVA (72)

TULA (RUS)

TUSHINO (RUS)

TÜRSCHLOSS (D)

• TAS (165)

TWINLOCK (GB)

TWIRHONB (F)

• ASIA (18)

TZAFRER (GR)

+ • CISA (48)

+ • GEGE (84)

UAP (GB)

PER:
FOR:

TRIOVING

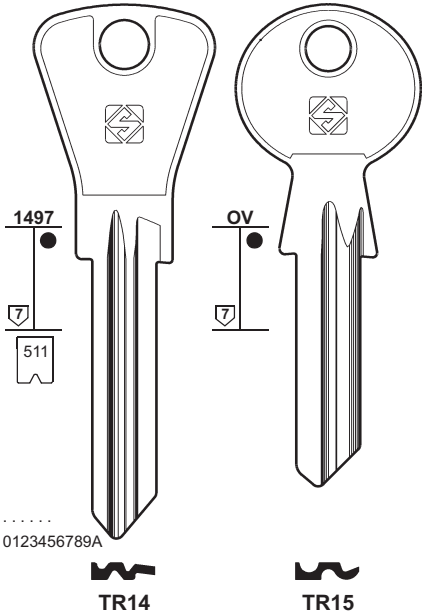

TRI STAR

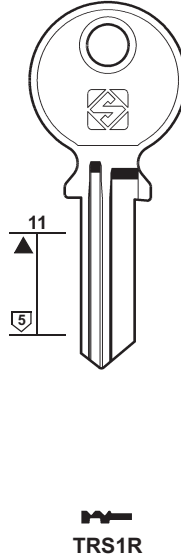

TULA

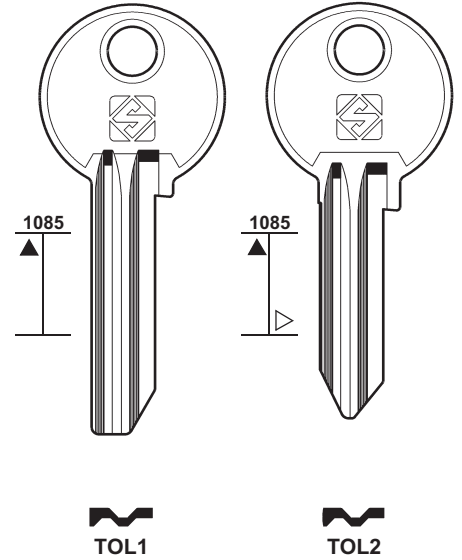

PER:
FOR:

TUSHINO

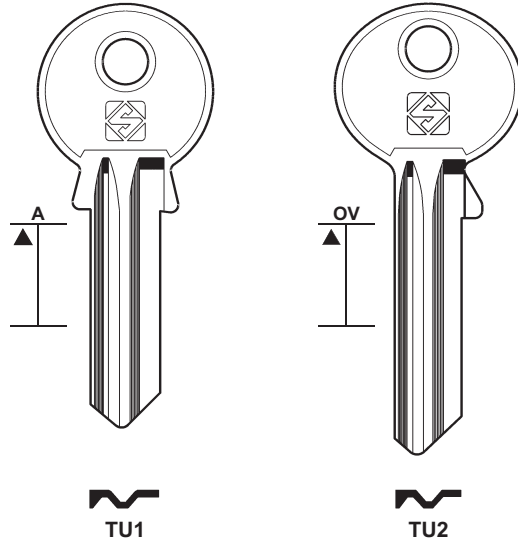

TWINLOCK

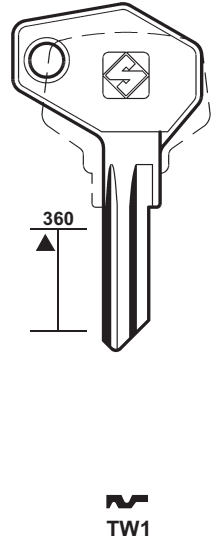

PER:
FOR:

TZAFRER

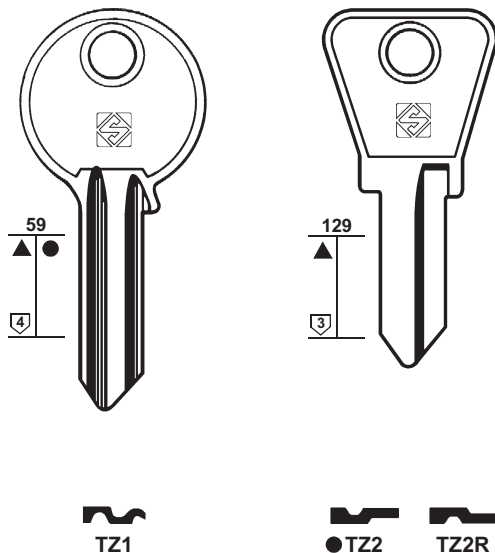

UAP

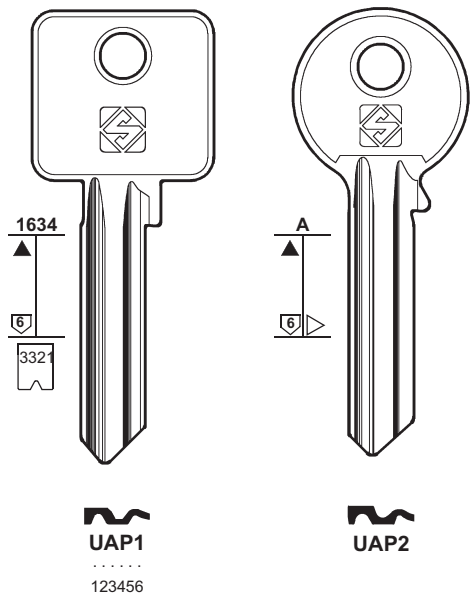

PER:
FOR: **UCEM**

29
811
UC2

1204
UC6R

P244
S170
S196
UC3RP
2000S

1203
S170
S196
UC5R

1203
UC4R

UC1 UC1R UC6R UC3RP UC5R UC4R

..... 1-2-3-4-5-6

CIB - RIV

ESAFE - ISEO
YEMAR



175

PER / FOR

UCEM (E)
CIB
ESAFE
ISEO
RIV
YEMAR

UEME (BR)

ULIANOVSK (RUS)

ULTRA (GB)
L & F (116)

UMF (P)
+ YALE (193)

UNIFERRO (F)
CISA (48)

UNIFOR (I)
PREFER (142)

PER:
FOR: **UCEM**

1386
UC8R

PER:
FOR: **UEME**

1156
UE5R

1156
UE4R

1292
UE2R

PER:
FOR: **UEME**

1292
UE3R

PER:
FOR: **ULIANOVSK**

1088
ULS1R

PER:
FOR: **UMF**

54
UM1

A
UM2



176

PER / FOR

UNION (GB)
HENDERSON
ONIUN

PER:
FOR:

UNION

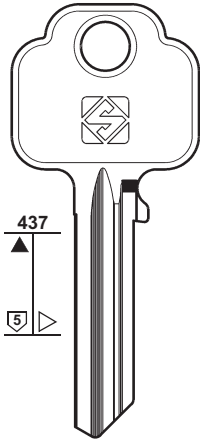

UNI66R B-MLA
UNI68R NE

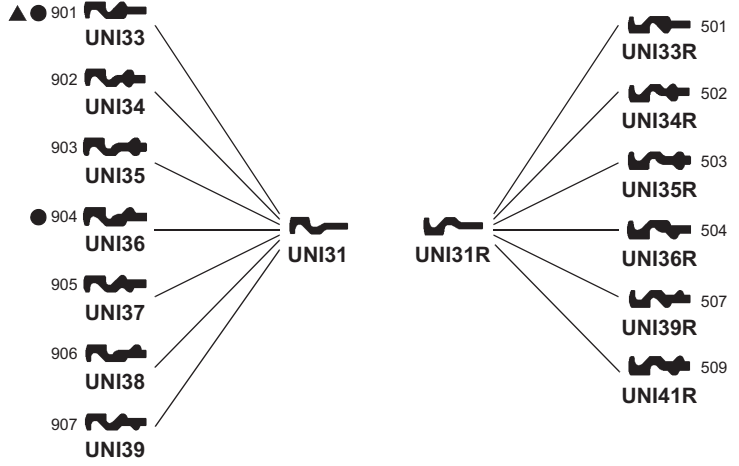

PER:
FOR:

UNION

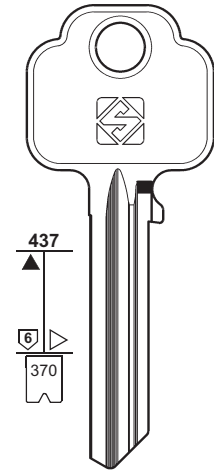

UNI67R B-MLA

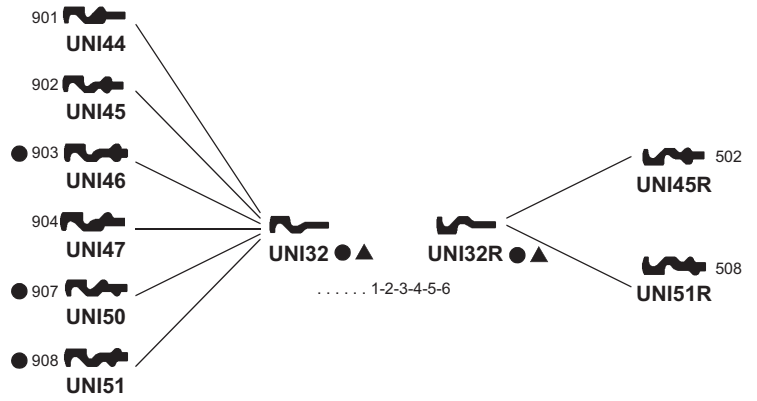

PER:
FOR:

UNION

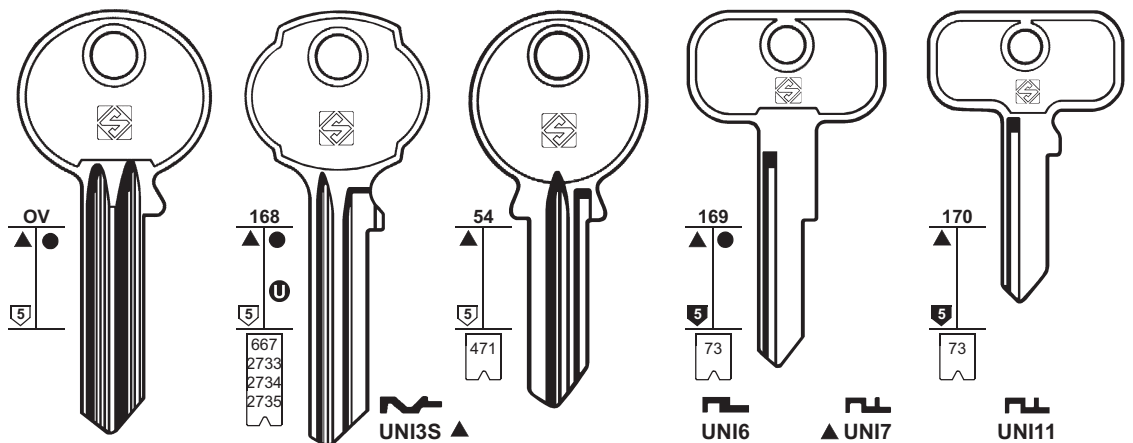

UNI28 KB506
UNI3 KB502
UNI3S
UNI54R ZA1
UNI18 NJ
UNI6
UNI16
UNI17
UNI16R
UNI11
UNI14

ONIUN

PER:
FOR:

UNION

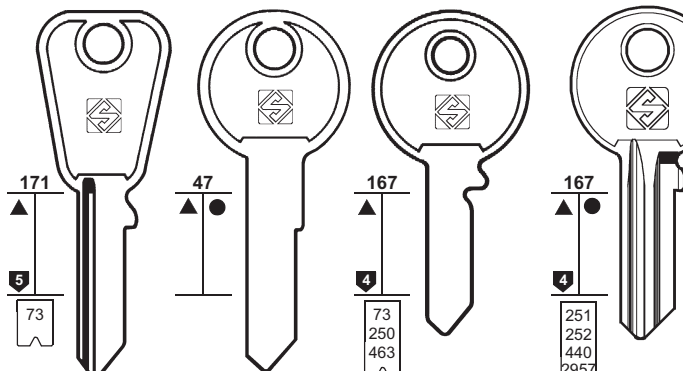

NKL ... 151-300
NND ... 151-300
TBS ... 201-350

NKW/A ... 1001-1100
NKW/A ... 1-100
NKW/X ... 1-100
NKW/H ... 1-50
NKL ... 301-450
NND ... 1-150
NND ... 301-450
NPK ... 1-100

TBS ... 1-100
NKL ... 1-150
NND ... 1-150
TBS ... 1-50
TBS ... 101-200
TBS ... 201-300
TBS ... 201-350
TBS ... 301-400
TBS ... 401-500



UNI61R
TBS ... 201-350
RV ... 1-450

UNI57R
NKW/X ... 101-200
NKW/A ... 101-200
NKW/A ... 1101-1200

UNI12
FP ... 626-750

UNI15
... 1-99
FS ... 1-99
FS ... 876-955

UNI29
KB682

UNI4
NRA
FFE ... 1-100
FL ... 251-500
NRA ... 51-90
FG ... 1-30
NF ... 1-30
EJR ... 1-75
FMO ... 1-75

UNI4R
EJR ... 1-75

UNI5
NGN ... 1-54

UNI63

UNI27
KB53A



177

PER / FOR

UNION (GB)

UNIVERSAL

PER:
FOR:

UNIVERSAL SERIE DISTINZIONE

HEAD TYPE / TESTA TIPO **N**

HEAD TYPE / TESTA TIPO **A**

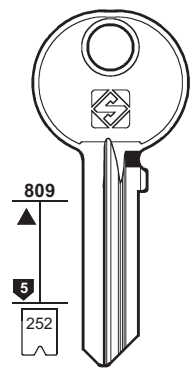

UNI59R
NKW/A ... 1-100
NKW/A ... 1001-1100
NPK ... 1-100

UNI60R
NKW/X ... 201-300
NKW/A ... 201-300

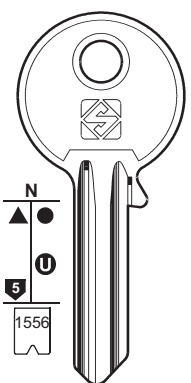

UL058
... 123456

UL059

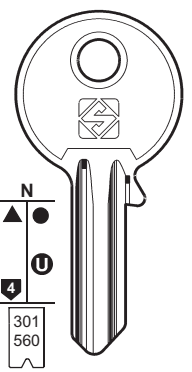

UL060
... 501-700
... 1001-1500

UL061

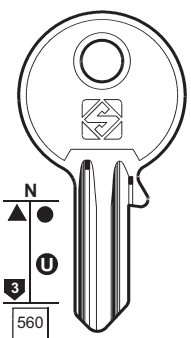

UL056
... 1701-1810
... T 1-113

UL057 ▲ ●

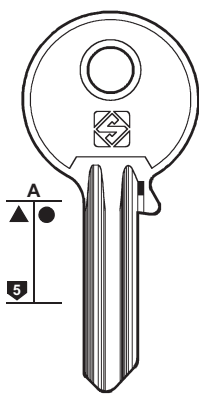

UL058A

UL059A

PER:
FOR:

UNIVERSAL SERIE DISTINZIONE

HEAD TYPE / TESTA TIPO **A**

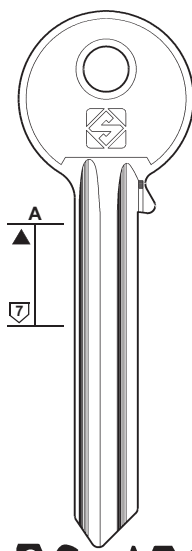

UL046

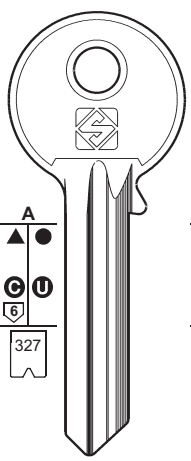

UL047

UL054 ... 123456

UL055 ▲ ●

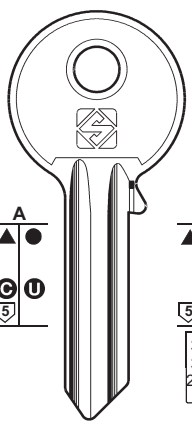

UL050

UL051

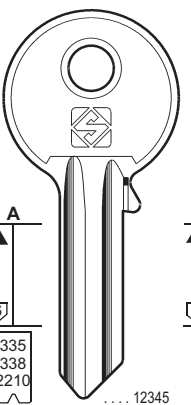

UL062

UL063

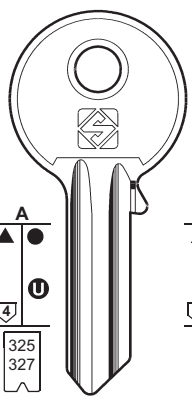

UL052 ... 0123456789
... 123456

UL053 ... 123456

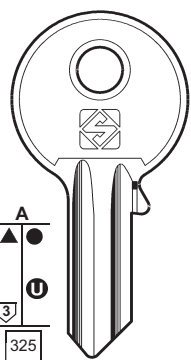

UL048

UL049



178

PER / FOR
UNIVERSAL

PER:
FOR:

UNIVERSAL SERIE DISTINZIONE

HEAD TYPE / TESTA TIPO **B**

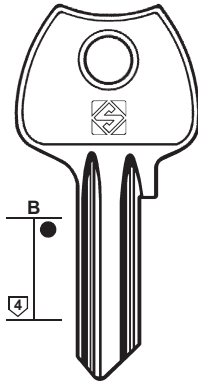
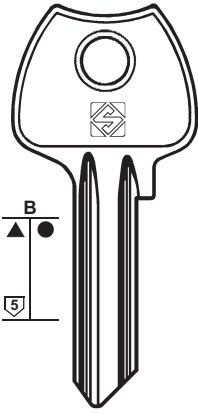

HEAD TYPE / TESTA TIPO **C**

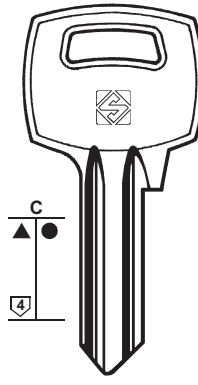
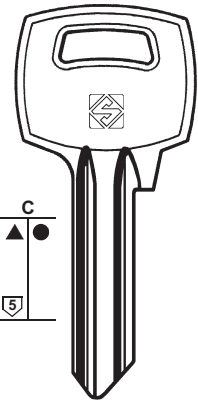

PER:
FOR:

UNIVERSAL SERIE DISTINZIONE

HEAD TYPE / TESTA TIPO **D**

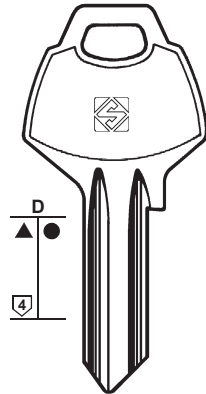
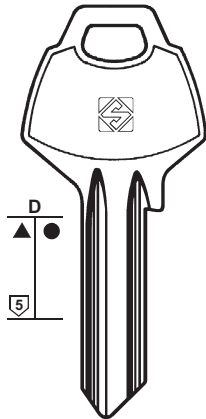

HEAD TYPE / TESTA TIPO **E**

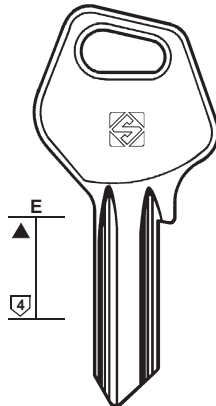
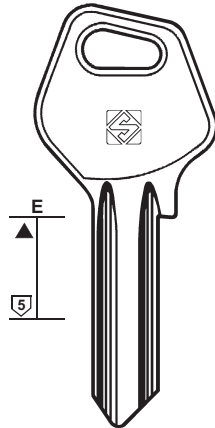

PER:
FOR:

UNIVERSAL SERIE DISTINZIONE

HEAD TYPE / TESTA TIPO **F**

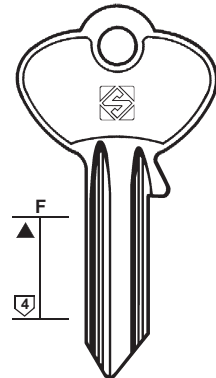
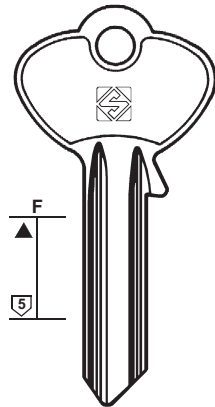

HEAD TYPE / TESTA TIPO **G**

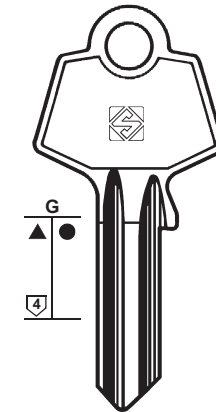
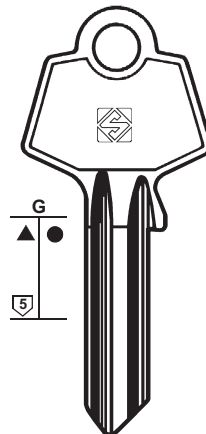

PER:
FOR:

UNIVERSAL SERIE DISTINZIONE

HEAD TYPE / TESTA TIPO **H**

HEAD TYPE / TESTA TIPO **L**

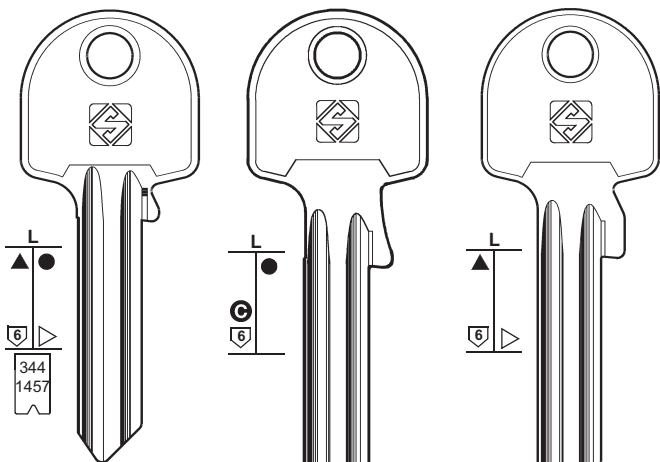
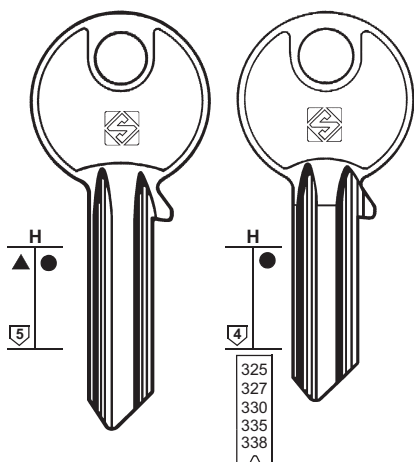

UL050H

UL052H

UL054L

UL054SL

UL054XL

..... 012345678
 0123456789
 12345
 123456

..... 344
 1457
 ● UL055L 12345678
 123456789

UL055SL

UL055XL



179

PER / FOR
UNIVERSAL

PER:
FOR:

UNIVERSAL SERIE DISTINZIONE

HEAD TYPE / TESTA TIPO **L**

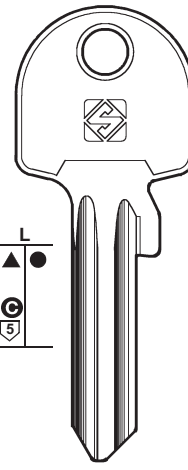
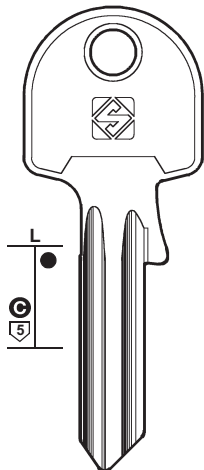
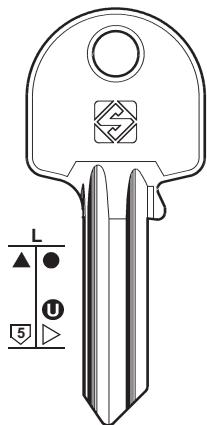

UL050L

UL050SL

UL050XL

● UL051L

UL051SL

● UL051XL

PER:
FOR:

UNIVERSAL SERIE DISTINZIONE

HEAD TYPE / TESTA TIPO **L**

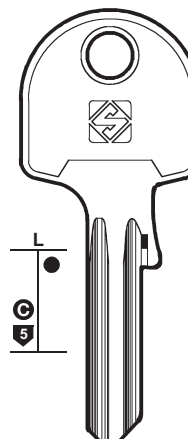
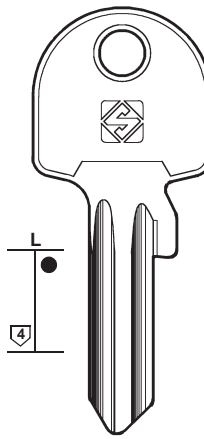
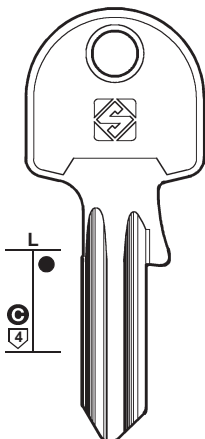
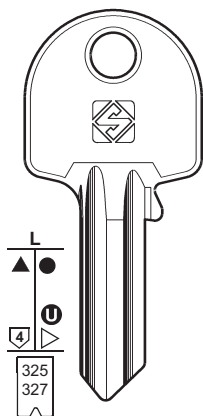

UL052L 0123456789
 123456

UL052SL

UL052XL

UL058SL

UL053L 123456

UL053SL



180

PER / FOR

UNIVERSAL

U.P.R. (D)

URBIS (R)
BSS
YALE

URKO (E)

UTZ (CH)

👁️ FORT (81)
👁️ L & F (116)
👁️ SIS (156)

VACHETTE (F)

ISEO
KILT
SANPEUR
+ 👁️ ISEO (98)
+ 👁️ KWIKSET (108)
+ 👁️ TITAN (168)
+ 👁️ TOK-WINKHAUS (170)
+ 👁️ VEGA (185)

PER:
FOR:

UNIVERSAL SERIE DISTINZIONE

HEAD TYPE / TESTA TIPO **M**

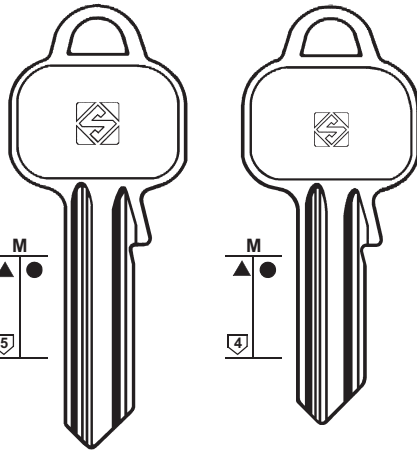

UL050M

UL052M

UL051M

UL053M

HEAD TYPE / TESTA TIPO **OV**

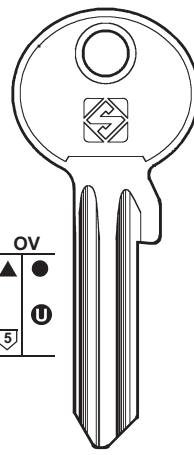

UL050X

UL051X

HEAD TYPE / TESTA TIPO **Y**

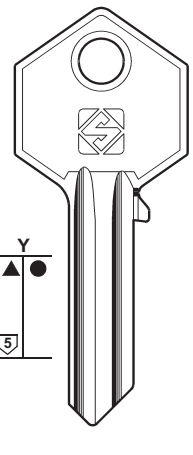

UL050Y

UL051Y

PER:
FOR:

U.P.R.

URBIS

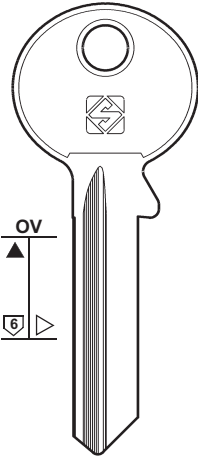

UP1

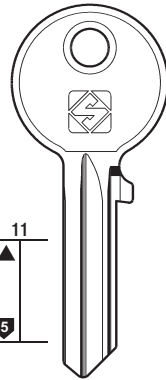

UB1R

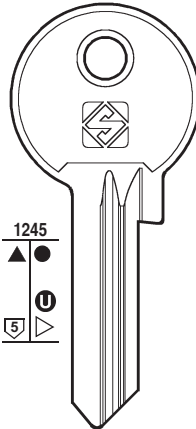

UB2R

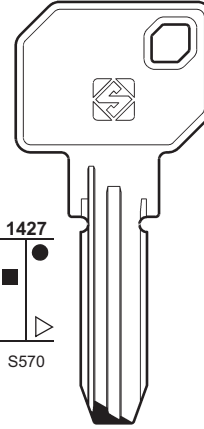

UB3

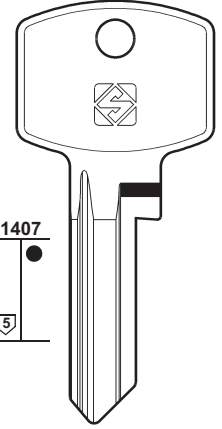

UB5

YALE



BSS - YALE

PER:
FOR:

URKO

VACHETTE

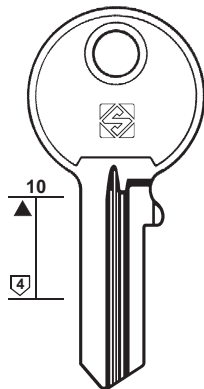

UR1

UR1R

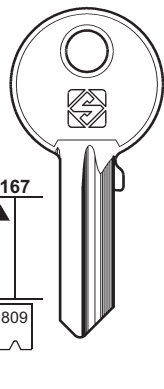

UR2

UR2R

1-2-3-4-5-6

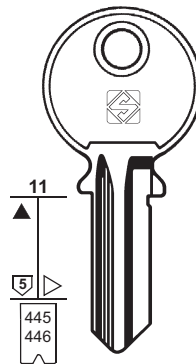

VAC46

..... 1-2-3-4-5-6-7-8
B..... 1-2-3-4-5-6-7-8
..... E 1-2-3-4-5-6-7-8-9-0



mm 40-50-60

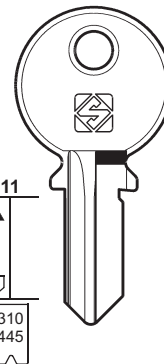

VAC1

VAC1R

E..... 9001-9100
..... E 300-499
..... R 9001-9100
..... 1-2-3-4-5-6-7-8-9-0
..... 1-2-3-4-5-6-7-8-9-0
..... E 1-2-3-4-5-6-7-8-9-0



mm 30

ISEO - KILT

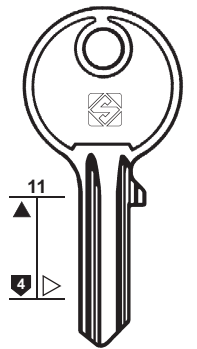

VAC8

VAC8R



SANPEUR

PER:
FOR:

VACHETTE

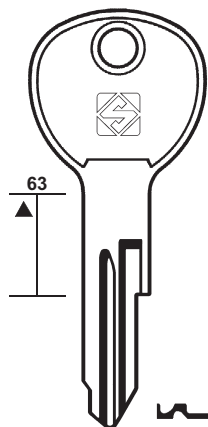

VAC44R

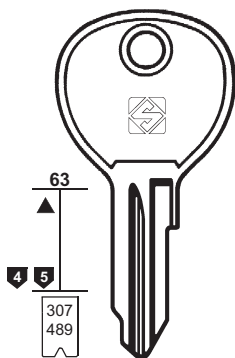

VAC25
R... 0-423



VAC25R
G... 0-423
D... 0-321

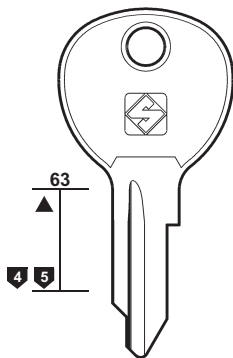

VAC106
RS



VAC106R
GS

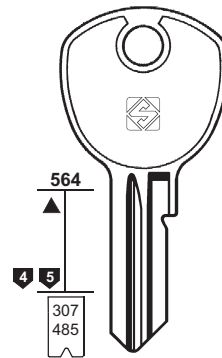

VAC65
R... 0-423
G... 600-644



VAC65R
G... 0-423
R... 600-644



VAC100



VAC100R



VAC33
V... 0-423



VAC33R
W... 0-423



VAC107
VS



VAC107R
WS



VAC66
V... 0-423
V... 600-644



VAC66R
W... 0-423
W... 600-644

VINCO

ATAL - VINCO

ATAL - VINCO



181

PER / FOR

VACHETTE (F)

ATAL
DAD
FONTAINE
HEMA
JU
METALUX
MODERN BAU
RUKA
RONIS
VINCO

- + ISEO (98)
- + KWIKSET (108)
- + TITAN (168)
- + TOK-WINKHAUS (170)
- + VEGA (185)

PER:
FOR:

VACHETTE

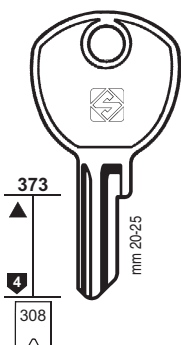

VAC42

BL... (G) A0-H9
K... A0-H9
LB... 0-49
LG... 0-49



VAC42R

RL... A0-H9
LR... (G) 0-49



VAC60

VL... (V) A0-H9
LV... 0-49



VAC60R

WL... (W) A0-H9
LW... 0-49



DAD - JU

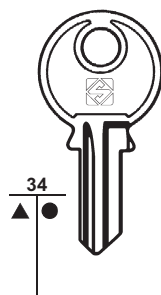

VAC11

▲



RUKA

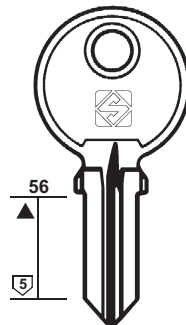

VAC10

▲

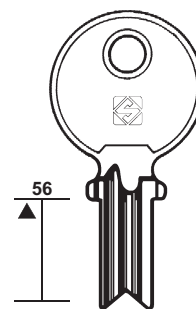

VAC41

▲

PER:
FOR:

VACHETTE

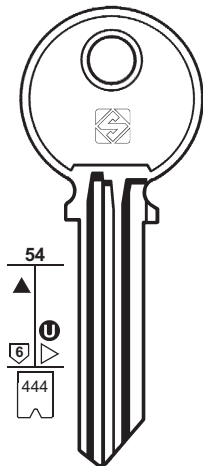

RO41

... 1-1296
... 1-2-3-4-5-6-7-8-9-0
V20... 1-1296
A/Z 1-2-3-4-5-6-7-8-9-0



DAD - RONIS

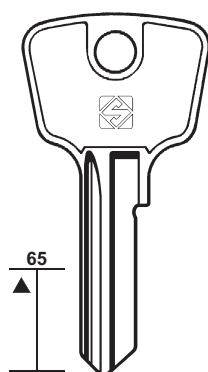

VAC14

▲



mm 40-50-60

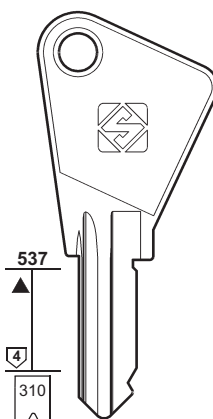

VAC61

EE... 9001-9100
E... 2-3-4-5-6

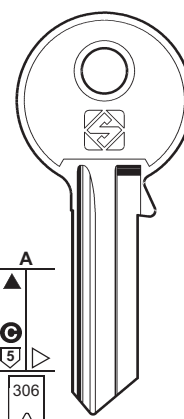

VAC29

A1... 5001-5631

FONTAINE - HEMA
METALUX - MODERN BAU



182

PER / FOR

VACHETTE (F)

- + ISEO (98)
- + KWIKSET (108)
- + TITAN (168)
- + TOK-WINKHAUS (170)
- + VEGA (185)

PER:
FOR:

VACHETTE

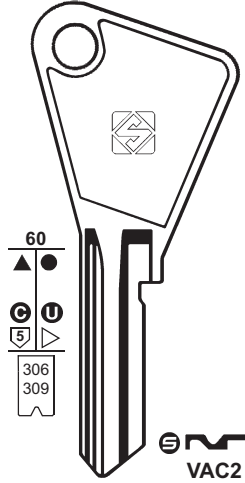

VAC2

- A1 ... 5001-5631
- UL ... 1-3500
- U ... 1-2-3-4-5-6-7-8-9-0
- U0 ... 1-9999
- UA ... 0001-1252
- UB ... 0001-5002
- UA ... 0830-6334
- LA ... 0000-6334

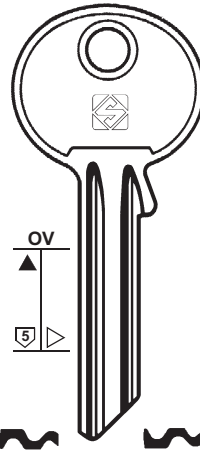

VAC30 VAC30R

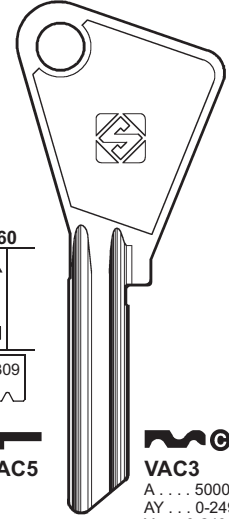

VAC5 VAC3

- A ... 5000-5635
- AY ... 0-249
- Y ... 0-249
- AS ... 0-099
- S ... 0-099
- A ... 2000-2999
- A ... 3000-3199
- AA ... 0000-1999



PER:
FOR:

VACHETTE

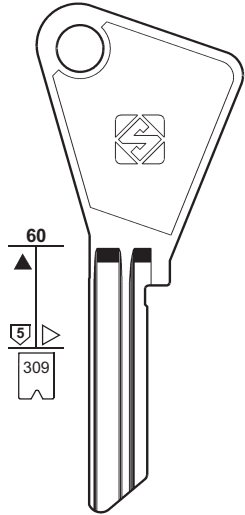

VAC56
AM ... 870-894

VAC47
BM ... 870-894

VAC57
CM ... 870-894

VAC58
DM ... 870-894

VAC63
AM ... 870-894
BM ... 870-894
CM ... 870-894
DM ... 870-894

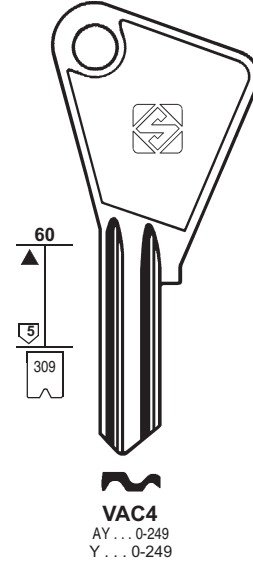

VAC4
AY ... 0-249
Y ... 0-249

PER:
FOR:

VACHETTE

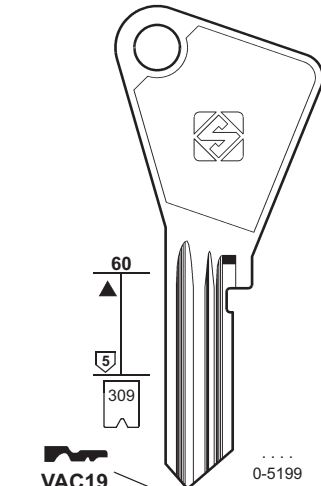

VAC19
.....
0-5199

VAC20
LHK
VAC22

LGK
VAC21

LA-AK
VAC15

LB-BK
VAC16

LC-CK
VAC17

LE-EK
VAC19N

LF-FK
VAC20N

LG-GK
VAC21N

LJ-JK
VAC34R

LK-KK
VAC40

LL-LK
VAC31R

LD
VAC18

LDH
VAC23

LH
VAC22N

LDM
VAC37

LN
VAC6

LM
VAC36

LHM
VAC38

PER:
FOR:

VACHETTE



183

PER / FOR

- VACHETTE (F)**
 + ISEO (98)
 + KWIKSET (108)
 + TITAN (168)
 + TOK-WINKHAUS (170)
 + VEGA (185)

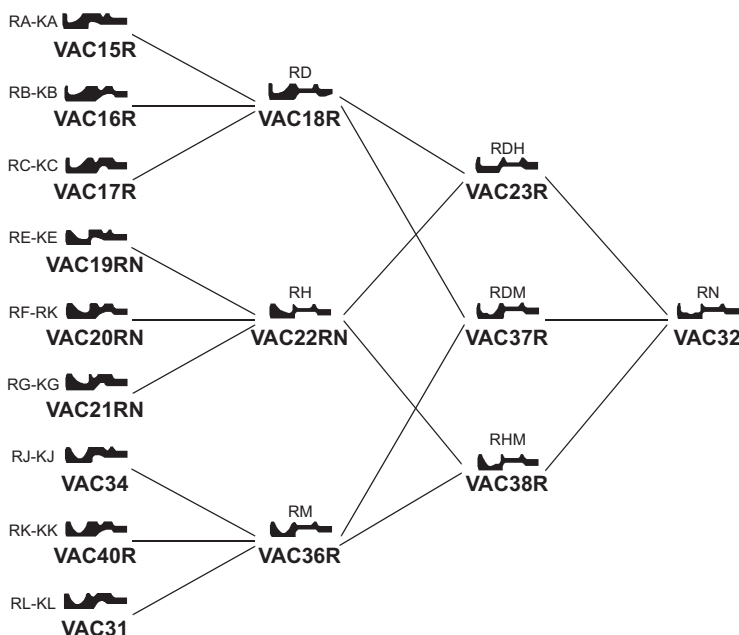
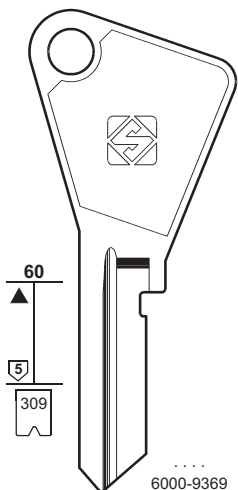

PER:
FOR:

VACHETTE

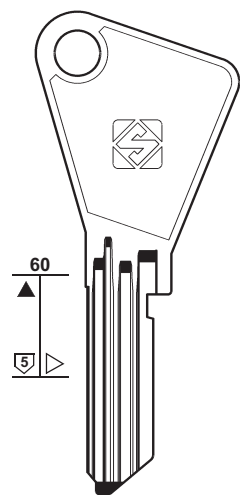

VAC101 KM235	VAC108 K200	VAC109 L202	VAC110 L226	VAC111 L229	VAC112 L230	VAC113 L240
VAC114 KL229	VAC115 K247	VAC116 KM236	VAC117 M258	VAC118 L225	VAC119 L243	VAC120 K023
VAC121 K024	VAC122 K025	VAC123 K234	VAC124 K235	VAC125 K236	VAC126 K237	VAC127 K238
VAC128 K239	VAC129 K240	VAC130 K242	VAC131 K243	VAC132 K244	VAC133 K245	VAC134 P294
VAC135 L019	VAC136 L020	VAC137 L021	VAC138 L022	VAC139 L223	VAC140 L224	VAC141 L227
VAC142 L228	VAC143 L239	VAC144 L244	VAC145 L245	VAC146 L246	VAC147 K020	VAC148 K021



184

PER / FOR

VACHETTE (F)

- AZMA
- CAP
- LAPERCHE
- + ISEO (98)
- + KWIKSET (108)
- + TITAN (168)
- + TOK-WINKHAUS (170)
- + VEGA (185)

VADETO (D)

- BLASER (32)

PER:
FOR:

VACHETTE

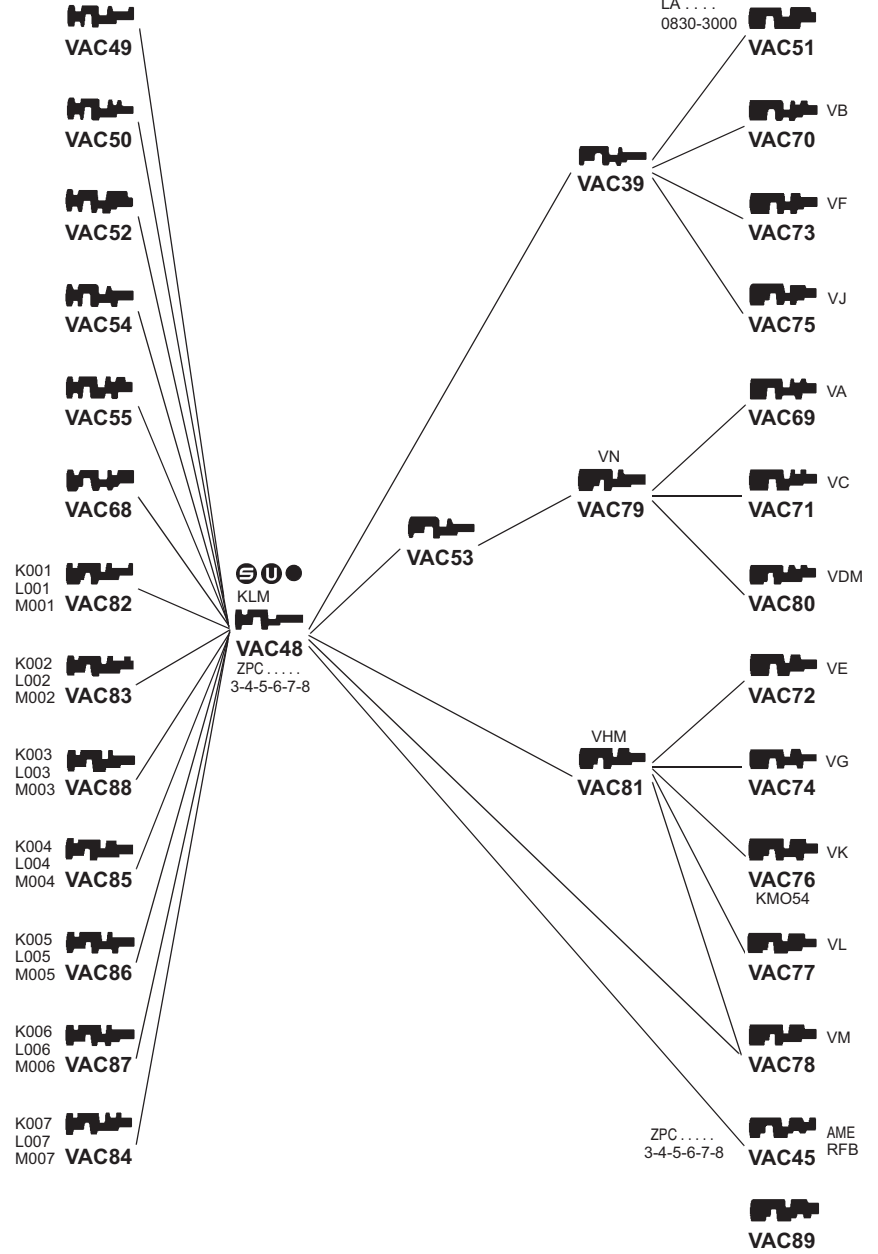
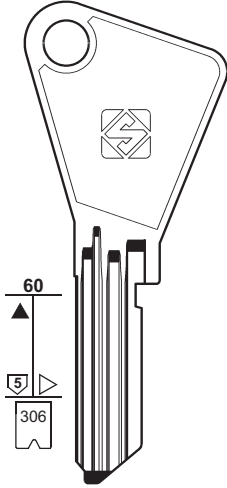

PER:
FOR:

VACHETTE

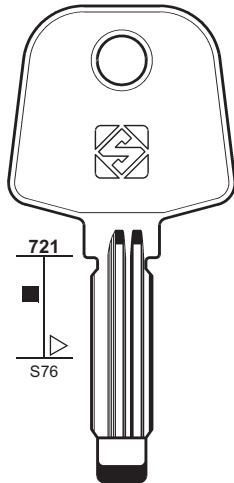

VAC91 VAC103

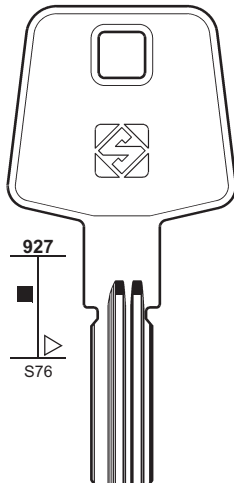

VAC104 VAC105

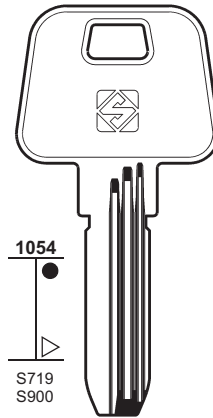

VAC150
V6

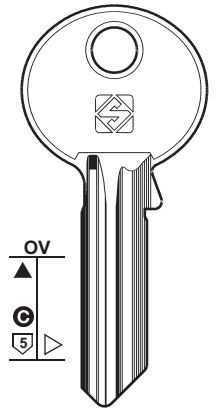

VAC151



LAPERCHE

PER: FOR:	VALE	VANGUARD	VARIOS
	VAL1	VGD1	VAR1
	VAL2		VAR1R

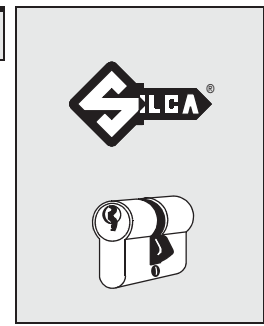

185

PER / FOR
VALE (RC)
VANGUARD (RA)
VARIO (D) 👁️ DOM (62)
VARIOS (E)
VASAR (RUS)
VAUGHN (GB) 👁️ HTV (93)
VBH (D) + 👁️ FCV (78) + 👁️ WILKA (191)
VDO (D) 👁️ KIENZLE (106)
VECO (E)
VEGA (F) VACHETTE + 👁️ ANTAR (17) + 👁️ RONIS (146)
VELO (RC) 👁️ YETI (198-199)
VENLOCK (YV) 👁️ WILSON BOHANNON (192)
VERA (CO) + 👁️ SATURN (151)
VERSCO (D) 👁️ CORBIN (53)

PER: FOR:	VARIOS	VASAR
	VAR5	VSR1R
	VAR2	VSR2
	VAR2R	VSR2R
	VAR3	
	VAR3R	
	VAR4	
	VAR4R	

PER: FOR:	VBH	VECO	VEGA	VERA
	VBH1R	VC1	VEG1	VR1
			VACHETTE	



186

PER / FOR

V.G.F. VILLATORE (I)

+ P.C. CORTELLEZZI (140)

VIDMAR (CH)

+ SEA (152)

VIKI (D)

+ DOM (62)

VINCO (D)

KARDEX
+ VACHETTE (181)

VING (N)

NOBO

VIOMETAL (F)

+ EURO LOCKS (71)

VIP (F)

+ CITY (51)

VIRO (I)

FEB
KÖNIG

+ ABLOY (4)

+ ELCA (68)

+ FAI (76)

+ TESA (166)

PER:
FOR:

V.G.F. VILLATORE

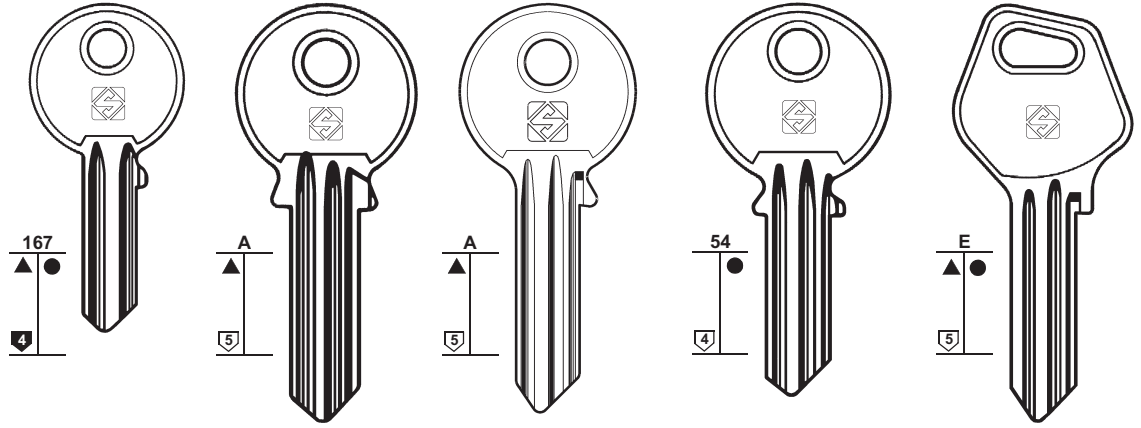

PER:
FOR:

VINCO

VING

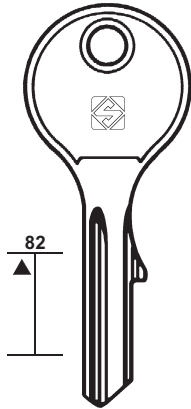

KARDEX

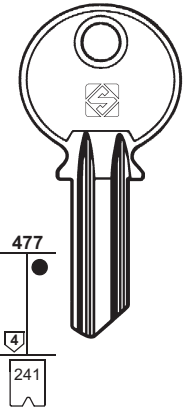
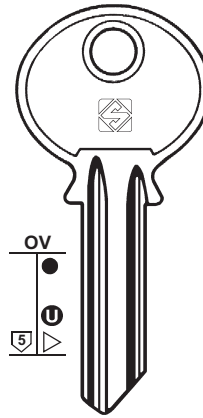
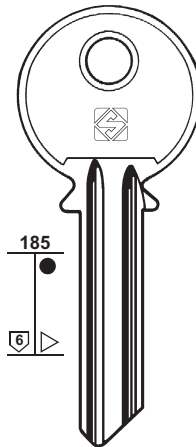

L... 5401-5650

NOBO

PER:
FOR:

VIRO

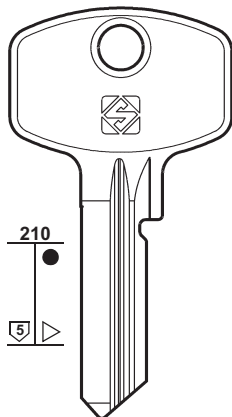

VI15R

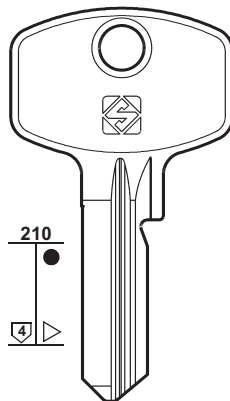

VI16R

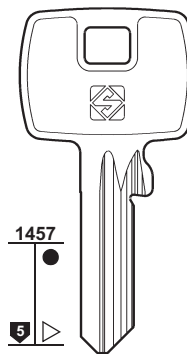

VI18R

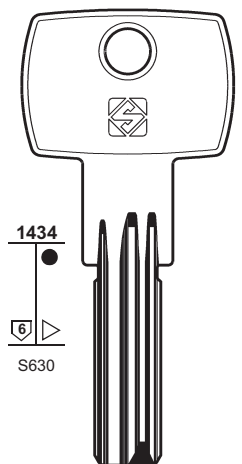

VI19
EURO-PRO

KÖNIG



FEB

PER:
FOR:

VIRO

VI8
VI8R
K
VI3
..... 012345
..... 6543210
VI3R
..... 012345
..... 6543210
..... 012345
..... 01234567
..... 012345
VI5
..... 012345
..... 01234567
VI5R
TS

VI1
SPECIAL
VI1R
VI6
VI12
VI13
VI23

VI080
VI081
.....
0-1-2-3-4-5-6
VI13
VI23

VI11
ABT
VI9
VI9R



187

PER / FOR

- VIRO (I)**
 ABT
 ABUS
 BERAM
 BURG
 FAI
 ROYAL
 WEISSENFELS
 + ABLOY (4)
 + ELCA (68)
 + FAI (76)
 + TESA (166)

PER:
FOR:

VIRO

VI2
VI2R
.....
0-1-2-3-4-5-6
VI10
..... 0-1-2-3-4-5-6
..... 0-1-2-3-4-5
ABT

VI10R
.....
0-1-2-3-4-5
ABT

ZD10P
.....
2001-3554
.....
8001-9554
VI082
VI083
.....
0-1-2-3-4-5-6
ABT

VI14
FAI

PER:
FOR:

VIRO

VI7
VI7R
.....
0-1-2-3-4-5

VI086
VI087
.....
0-1-2-3-4-5

VI4
VI4R
.....
1-2-3-4-5

VI17
VI084
.....
0-1-2-3-4-5

VI085
VI089
.....
1-2-3
VI088
VI089



BERAM - ROYAL
WEISSENFELS



BERAM - ROYAL



ABUS - ROYAL



ABUS - BURG
mm 20



188

PER / FOR

VIS (I)

VISO (RC)

- 👁️ FORT (81)
- 👁️ YETI (198-199)

VISONIC (RC)

- 👁️ ALPHA (15)

VJATKA (RUS)

VÖGEL (CH)

- 👁️ BAAL (25)

VOKO (D)

- 👁️ CES (42)
- 👁️ DOM (62)
- 👁️ JOWIL (100)

VOLGOGRAD (RUS)

VOLKOVYSK (RUS)

VOUGA (BR)

VS (D)

- 👁️ JUNIE (101)

WALE (RC)

- 👁️ YALE (195)

WALLY (I)

AKKA
MOREAUX

WANGGUAN (RC)

WANJIN (PRC)

HOOPLY

PER: FOR:	VIS	VJATKA	VOLGOGRAD	VOLKOVYSK	
	31 5	1101	1081	1081 5	1081
PER: FOR:	VOUGA	WALLY			
	1533	A 9	A 6	A 5 620	A 4 620
				1-2-3-4-5-6-7-8 MOREAUX	1-2-3-4-5-6-7-8
PER: FOR:	WALLY		WANGGUAN	WANJIN	
	H 3 619	11 5	401	1603 7	
	1-2-3-4-5-6-7-8				

PER: WASA-IVANA FOR:	WAUS	WEBER	

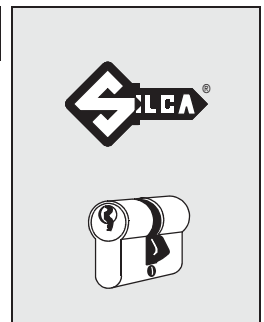

189

PER / FOR
WASA-IVANA (PL)
WASO (D) 👁️ CES (41-42)
WAUS (P)
WB (F) 👁️ KKL (107)
WEBER (D) WECO
WEBSTER (GB)
WECO (D) 👁️ CES (41-42) 👁️ WEBER (189) 👁️ YALE (194)
WEISER (USA) (GB) (B) FALCON FICHET IDEAL-SECURITY KAWE + 👁️ FALCON (76)
WEISSENFELS (D) 👁️ VIRO (187)
WELKA (I) + 👁️ YALE (193)

PER: WEBSTER FOR:	WEISER		
		<p>FICHET</p>	<p>KAWE</p>

PER: WEISER FOR:	WELKA			
<p>FALCON</p>	<p>IDEAL SECURITY</p>			



190

PER / FOR

WELKA (I)

+ YALE (193)

WEPA (D)

JOWIL (100)

WESCO (D)

KIFERM (106)

LAS (110)

WESLOCK (USA)

WEST (J)

WFE (D)

WHALE (i)

GLOBE (87)

PER:
FOR:

WELKA

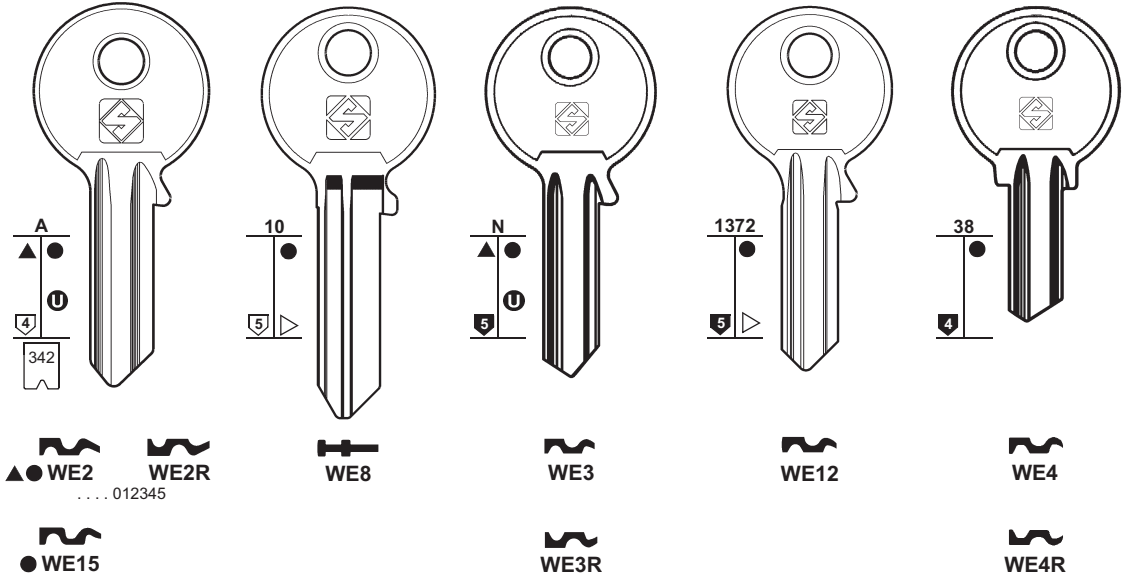

PER:
FOR:

WESLOCK

WEST

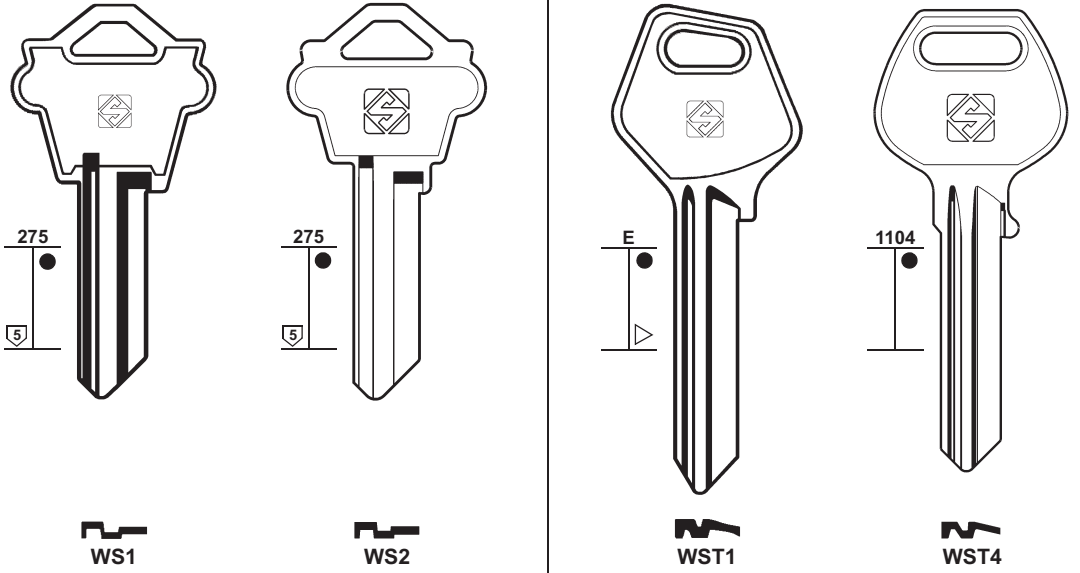

PER:
FOR:

WEST

WFE

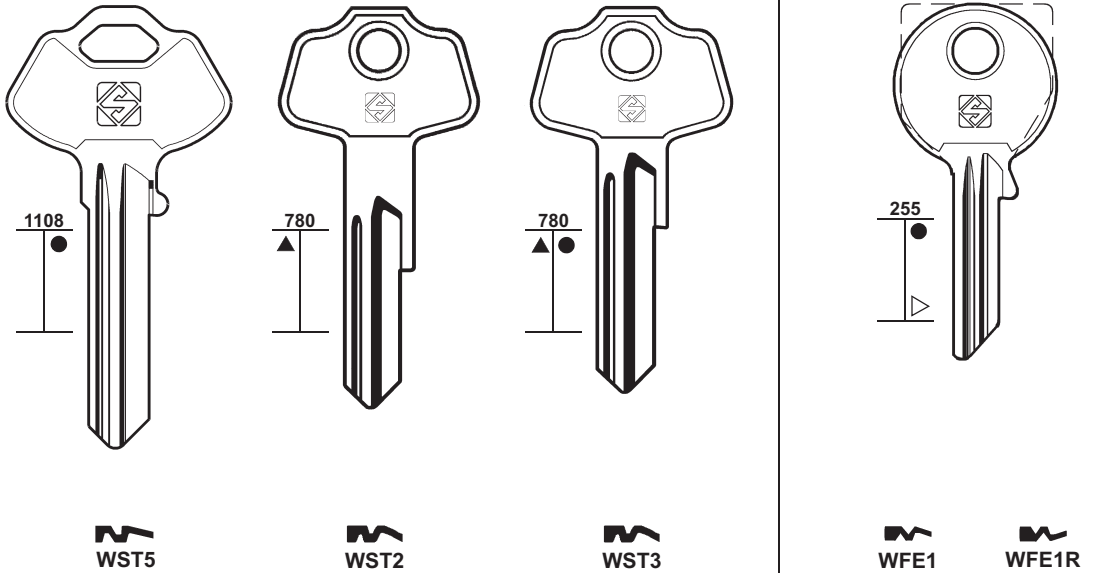

PER:
FOR:

WHITCO

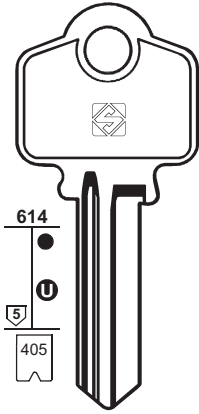

.....0123456789A

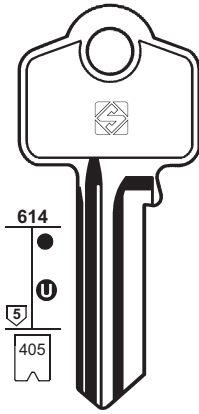

.....0123456789A

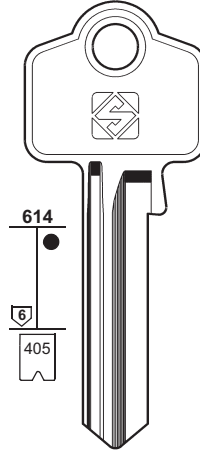

.....0123456789A



191

PER / FOR

WHITCO (AUS)

WIGRO (D)
WILKA (191)

WILKA (D)
CFP
DIERRE
DORMA
EMKA
GBS
JORE
TOP
VBH
WIGRO
+ BLASER (32)

PER:
FOR:

WILKA

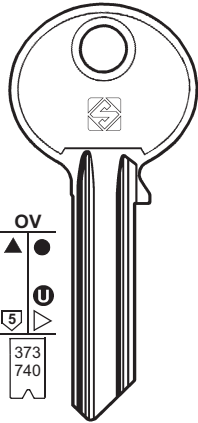
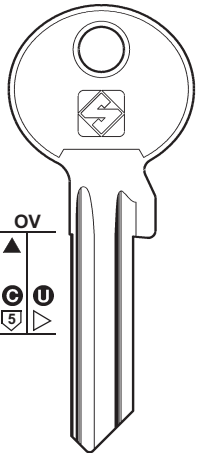

.....123456789
.....400001-430000

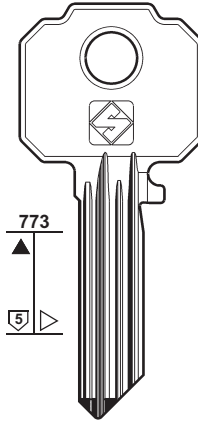

WK59R WK49R
WK60R WK50R
WK63R WK51R

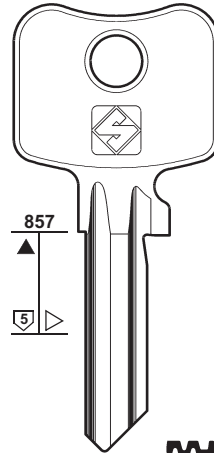

WK69
WK55 WK68R

JORE - TOP - WIGRO

EMKA - DIERRE - DORMA - VBH

PER:
FOR:

WILKA

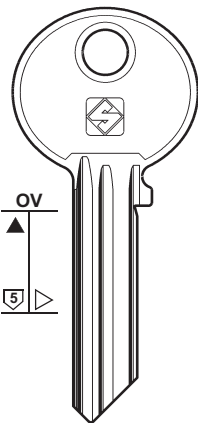
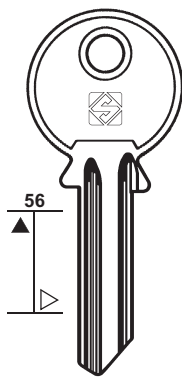
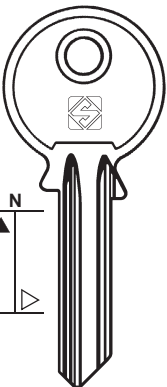

WK7 WK26 WK31 WK36 WK18
WK16 WK27 WK32 WK37 WK19
WK46 WK28 WK33 WK38 WK20
WK48 WK29 WK34 WK39 WK21
WK30 WK35 WK40 WK22
WK5

CFP - GBS



192

PER / FOR**WILKA (D)**
+ **BLASER (32)****WILLACH (D)**
 HUWIL (94)**WILLENHALL (GB)**
 GIBBONS (86)**WILSON BOHANNON (USA)**
VENLOCK**WINFIELD (RC)**
 YETI (198-199)**WINFOR (GB)**
 MERONI (124)**WINKHAUS (D)**
 TOK-WINKHAUS**WINLOCK (GB)****WINNER (F)**
 GABON (84)**WIREROPE (HK)****W.M.S. (GB)**
I.R.
TITUS
+ **AVOCET (24)****WOC (F)**
 YALE (193)**PER:
FOR:**

WILKA

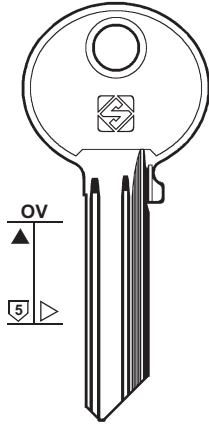

- | | | | | |
|-------|-------|-------|-------|-------|
| WK6 | WK4 | WK9 | WK2 | WK2R |
| WK6R | WK41R | WK42R | WK10 | WK17R |
| WK25 | WK15 | WK14 | WK45R | WK47R |
| WK25R | WK43R | WK13 | WK52R | WK56R |
| WK44R | WK53R | WK12 | | |
| | WK54R | WK11 | | |

**PER:
FOR:**

WILKA

WILSON BOHANNON

WINLOCK

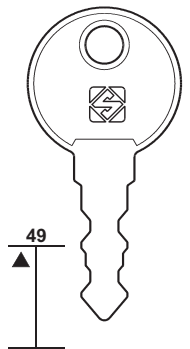
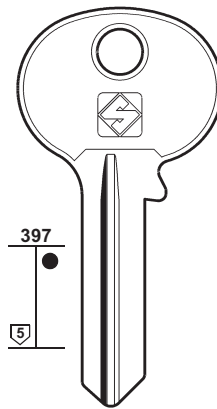
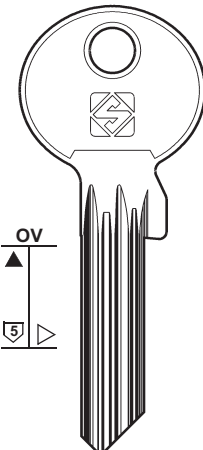
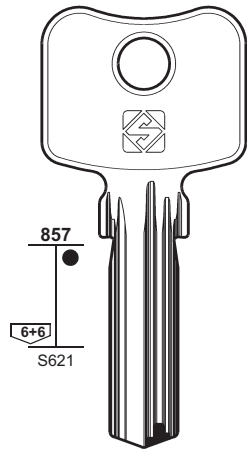
 WK70
.....
10001-43000

WK45X

WK71X

WH1

WLC1

**VENLOCK****PER:
FOR:**

WIREROPE

W.M.S.

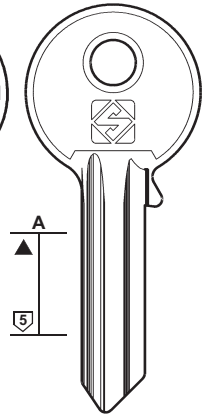
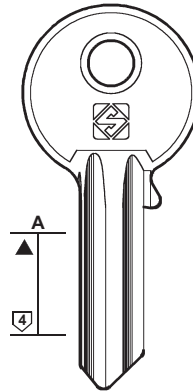
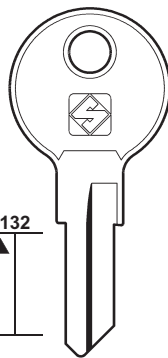
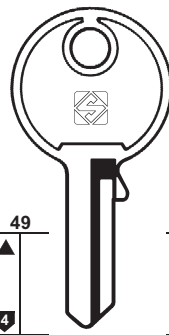
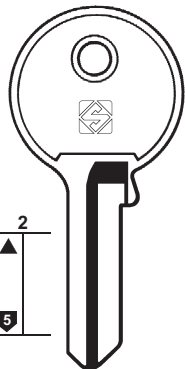
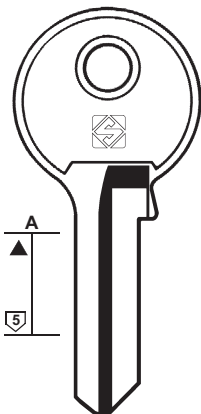

WR1

WR2

WR3







WR4

WR5R

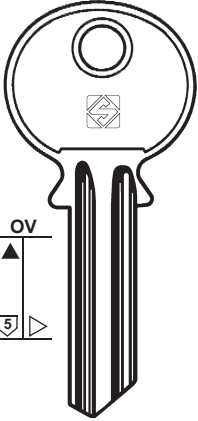
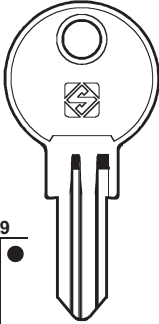
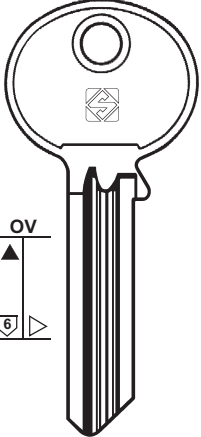
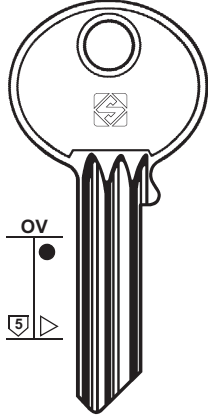
WMS1

WMS2

**I.R. - TITUS**



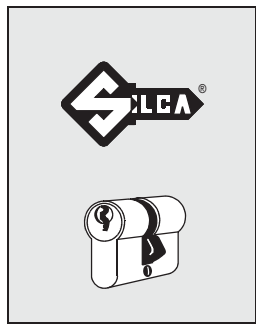





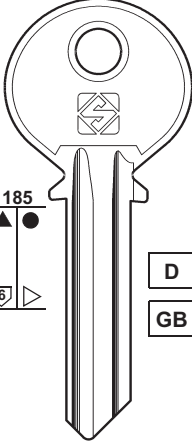
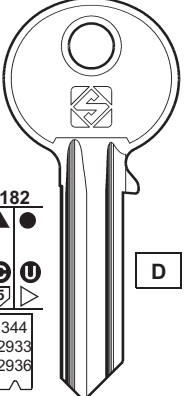
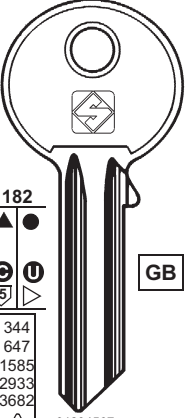
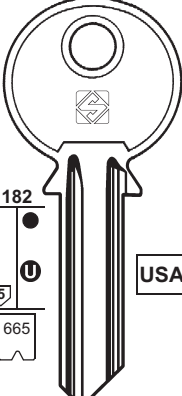
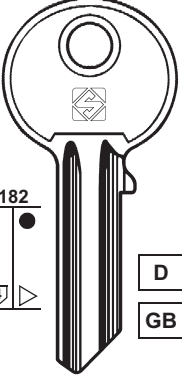

PER: FOR:	WS	XIEHE	YALE	
				
	OV ▲ 5	49 ● 4	OV ▲ 6	OV ▲ 5
	 			
			D GB	D GB



193

- PER / FOR**
- WS (D)**
 - WÜRTH (D)**
 - CORBIN (53)
 - HUWIL (94)
 - XIEHE (PRC)**
 - YAC (F)**
 - RONIS (147)
 - YALE (D) (GB) (USA)**
 - BIRD
 - BKS
 - CARAT
 - CKS
 - KALE
 - LAREDO
 - PRIVE
 - ROC
 - UMF
 - WELKA
 - WOC
 - + ● BKS (30-31)
 - + ● HTV (93)
 - + ● URBIS (180)

**PER:
FOR:** **YALE**

				
185 ▲ ● 6	182 ▲ ● 5	182 ▲ ● 5	182 ▲ ● 5	182 ▲ ● 4
D GB	D C U 5	GB C U 5	USA U 665	D GB 4
 	 	 		 
	BIRD - BKS - CARAT CKS - KALE - LAREDO ROC - WELKA - WOC		PRIVE	UMF

**PER:
FOR:** **YALE**

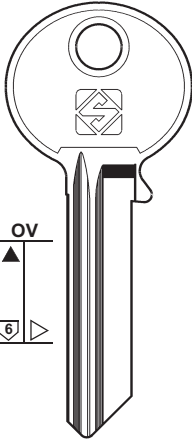
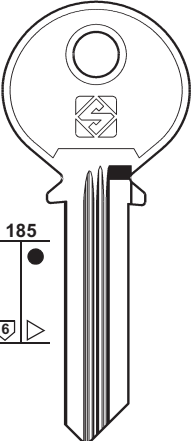
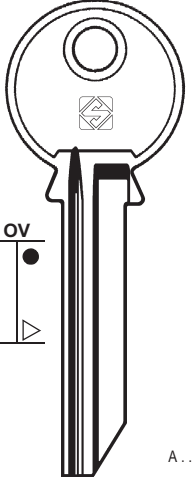
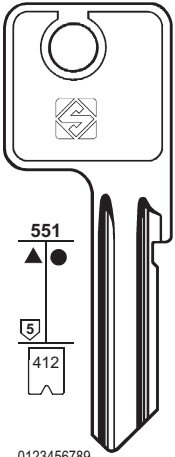
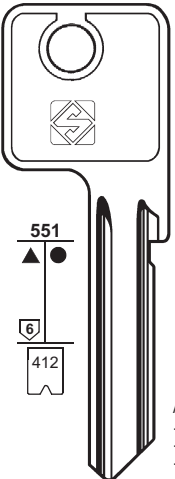
				
OV ▲ 6	185 ▲ ● 6	OV ▲ ●	551 ▲ ● 5	551 ▲ ● 6
YA84 YA84R	YA86 YA86R	YA67	YA35	YA64 YA64R
	YA85R	USA	USA	USA
			A 0123456789 0123456789 0123456789	YA34 ● A 0123456789 0123456789 0123456789 0123456789



194

PER / FOR

YALE (D) (GB) (USA)

ABUS
BENDIX
BKS
CAB
CHICAGO
COLE-HERSEE
HUDSON
SOUTHCO
SUREX
WECO

+ BKS (30-31)

+ HTV (93)

+ URBIS (180)

PER:
FOR:

YALE

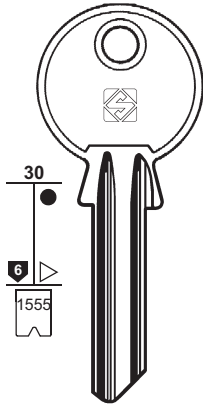

30
6
1555

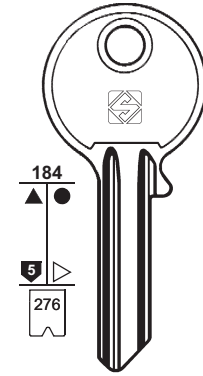

184
5
276

YA30
ABS ...
7537-8336

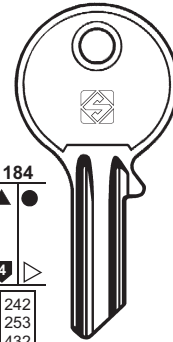

184
4
242
253
432
433
434
435
1555

YA8
FB ... 101-1100
FP ... 101-1100
R ... 101-160
MC ... 101-850



YA8E
BM...1-1000
KA...1-1000
KB...1-1024
AT...1-1040
A...1-1100
DB...1-1100
...1-1600
B...1-1600
BS...1-1600
D...1-1600
E...1-1600
F...1-1600
IC...1-1600
JA...1-1600
JD...1-1600
JB...1-1600
KV...1-20025
KD...1-4950
ABS...1-6000
D...1-750
R...10-101
KA...1001-2000
FB...101-1100
FP...101-1100
R...101-160
KV...100026-120025
BT...1451-2250
KV...20026-40025
CM...250-1349
DC...251-1350
FS...297-1396
KV...120026-140025
KV...40026-60025
FD...501-1600
KV...60026-80025
KV...80026-100025

YA21
TBS ... (AB) 401-450
SC ... (AB) 101-150

YA22
SC ... 1-50
TBS ... (AC) 451-500

YA23
SC ... (AD) 51-100
TBS ... (AD) 501-500

YA15
SX ... 1-1000
VR ... 1-4000
BX ... 1-500
VW ... 1-4000

YA24
TBS ... (BC) 551-600

YA25
SC ... (BC) 201-250
TBS ... (BD) 601-650

YA26
SC ... (CD) 151-200
TBS ... (CD) 651-700

YA15R
YA15R

RP ... 1001-3400



YA32



YA30R



YA3



YA8R
SUREX



YA8ER



BKS - WECO

PER:
FOR:

YALE

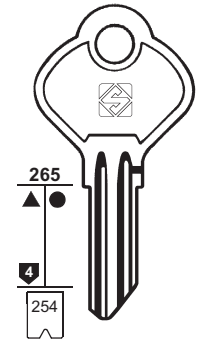

265
4
254

YA20

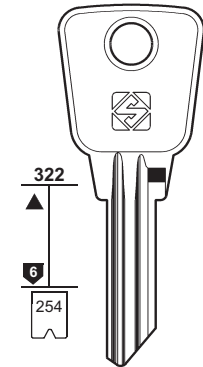

322
6
254

YA19
LT ... 1-100
LC ... 1-100

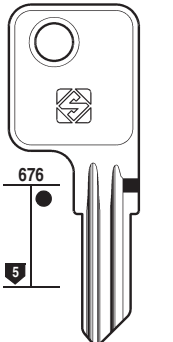

676
5

YA65

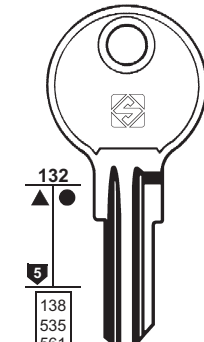

132
5
138
535
561
1069
1335

YA69

FL ... 201-240
LL ... 226-450
UM ... 226-450
... 500-550
... 600-650

YA18
SOUTHCO



YA17
DC ... 551-952
TOK ... 1-99
RS ... T 1-99



YA19R



YA65R



YA4
HC ... 001-202
KC ... 251-500



YA4R
CH ... 251-750

ABUS - BENDIX - CAB - CHICAGO
COLE-HERSEE - HUDSON

PER:
FOR:

YALE

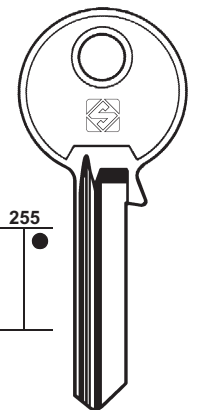

255

YA16L

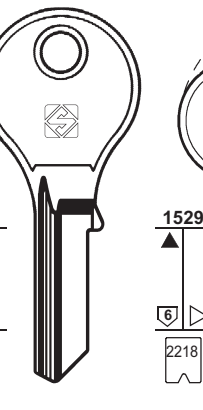

3

YA16RL

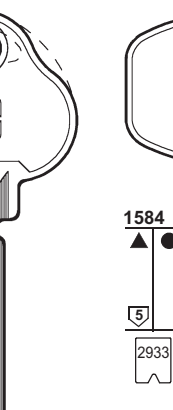

1529
6
2218

YA16

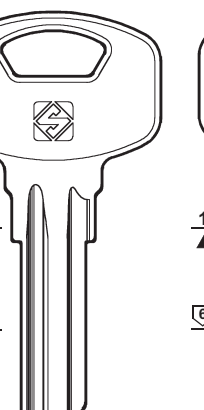

1584
5
2933

YA16R

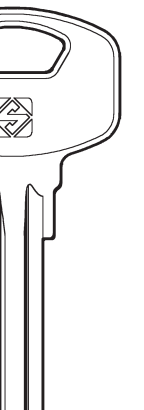

1584
6

YA88
X5

1-2-3-4-5-6-7-8-9

..... 123456789ABCDEFGHIJL



PER:
FOR:

YALE

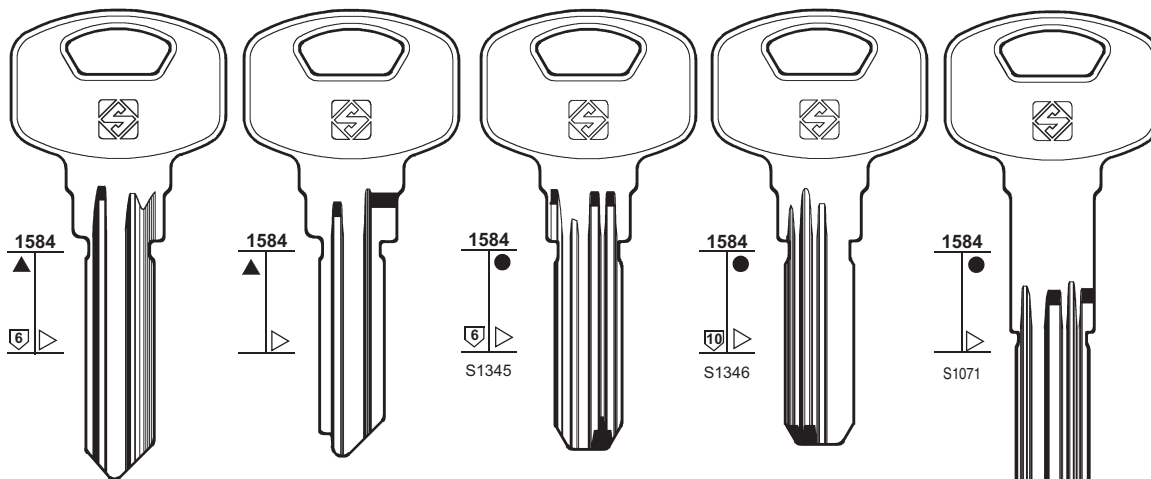

YA93

YA87
KTM

YA94
"1000 Series"



YA95R
"2000 Series"



YA90



195

PER / FOR

YALE (I)
FERCO
SOS
WALE

PER:
FOR:

YALE (I)

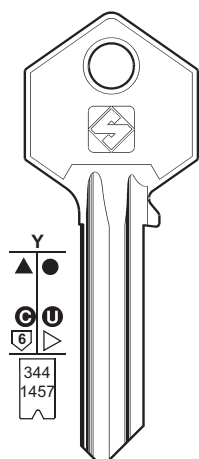

..... 0-1-2-3-4-5-6-7-8-9
..... 0-1-2-3-4-5-6-7-8

YA31 **YA31R**

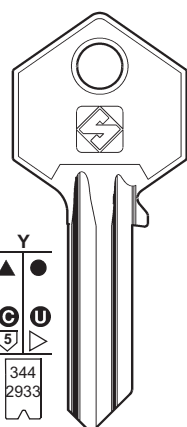

YA63

YA226 **YA227** 0123456789
..... 0-1-2-3-4-5-6-7-8-9

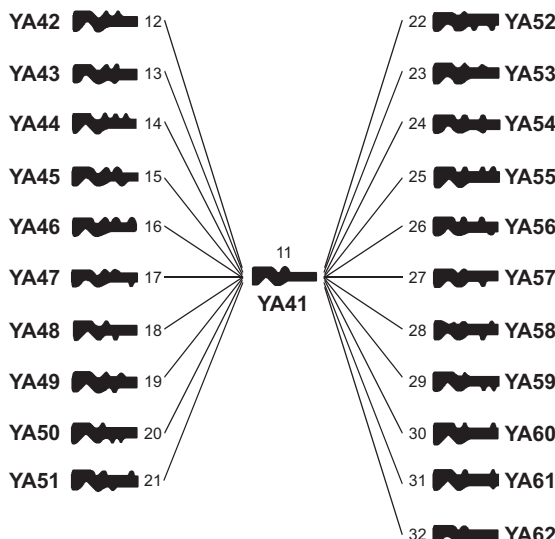

FERCO - WALE

PER:
FOR:

YALE (I)

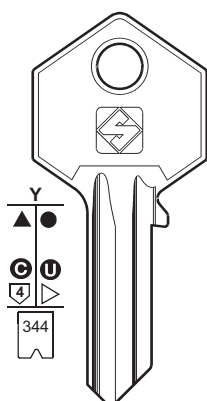

..... 0-1-2-3-4-5-6-7-8-9

YA6R

YA6

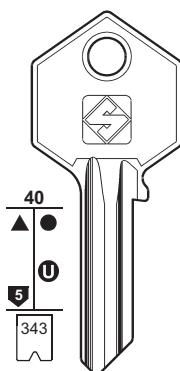

..... 1-2-3-4-5-6-7-8

YA7

YA7R

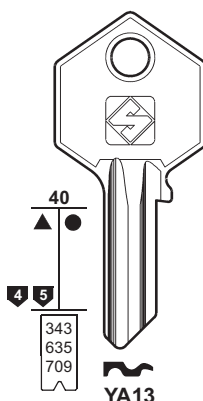

YA13

..... 1-2-3-4-5-6-7-8
..... 1-2-3-4
..... 0-1-2-3-4-5

YA13R

..... 0-1-2-3-4-5-6-7-8

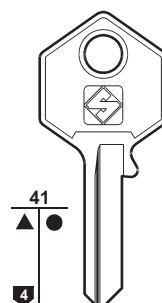

YA14

YA14R

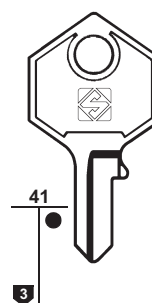

YA33



SOS - WALE



WALE



MIGNON



MIGNON



196

PER / FOR

YALE (I) (D) (GB) (USA)

+ BKS (30-31)

+ HTV (93)

+ URBIS (180)

PER:
FOR:

YALE (I)

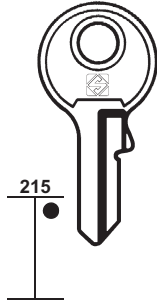

YA74



YA74R



MIGNON



CS28



CS28R



MIGNON

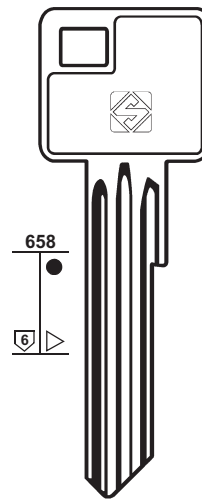

YA39

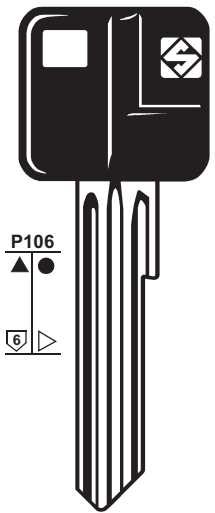

YA39P

PER:
FOR:

YALE (I)

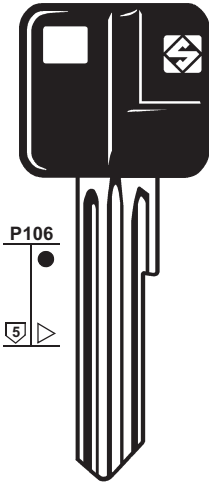

YA40P

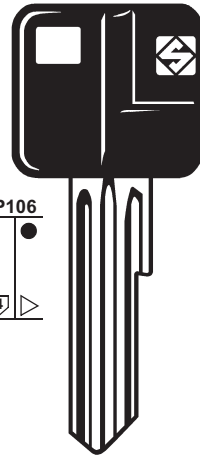

YA73P

YALE (USA)

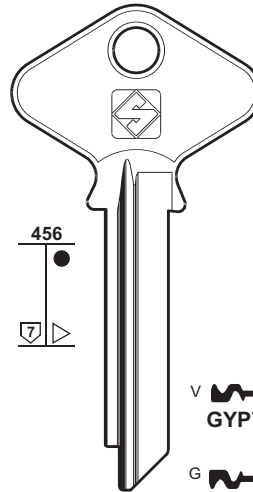

V GYP7R



G GYP7



GA GYA7

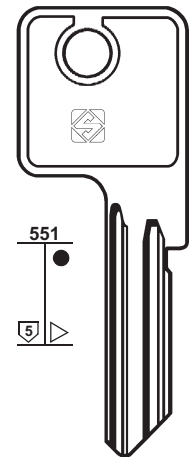

G GYP8



V GYP8R

PER:
FOR:

YALE

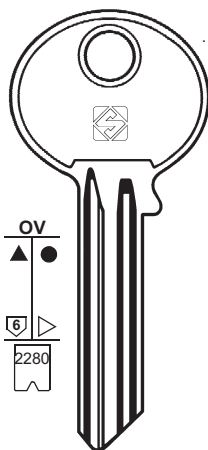

D GB



GA GYA6
..... 0-1-2-3-4-5-6



GC GYC6



GG GYG6



GB GYB6



GE GYE6



GH GYH6



GD GYD6



GF GYF6



GK GYK6



G GYP6B



G YA2



V YA2R



VYP6A



VA VYA6



VC VYC6



VG VYG6



VB VYB6



VE VYE6



VH VYH6



VD VYD6



VF VYF6



VK VYK6

PER:
FOR:

YALE

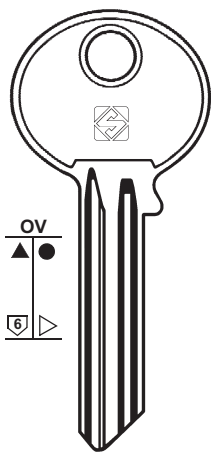

D GB

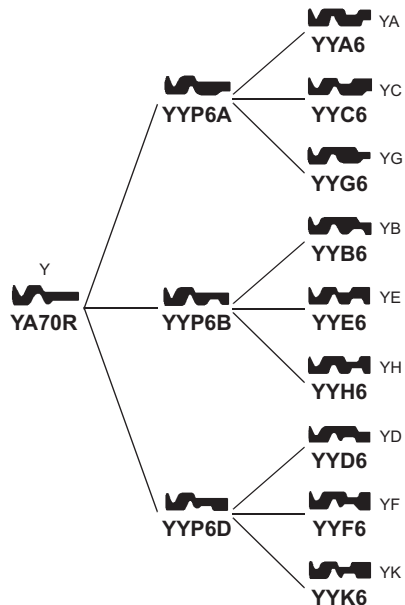
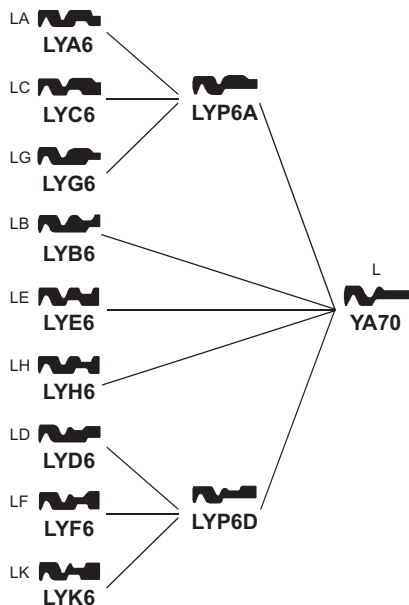

197

PER / FOR

YALE (D) (GB)
 + BKS (30-31)
 + HTV (93)
 + URBIS (180)

YALTRES (RA)
 FTH (82)

YANEDIS (GB)
 ETAS (70)

PER:
FOR:

YALE

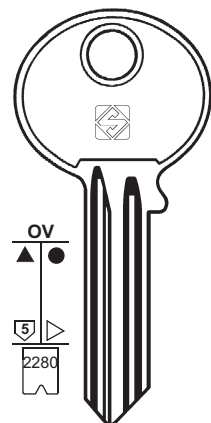

D GB

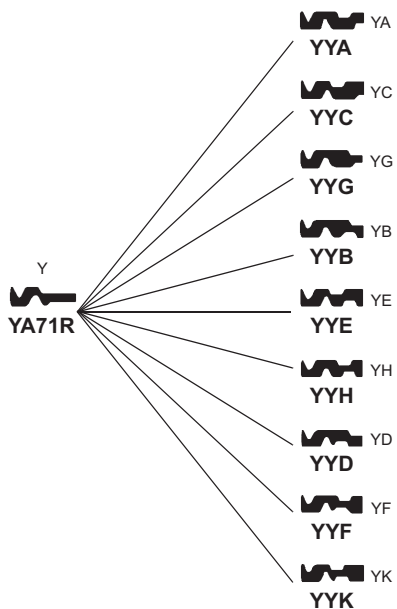
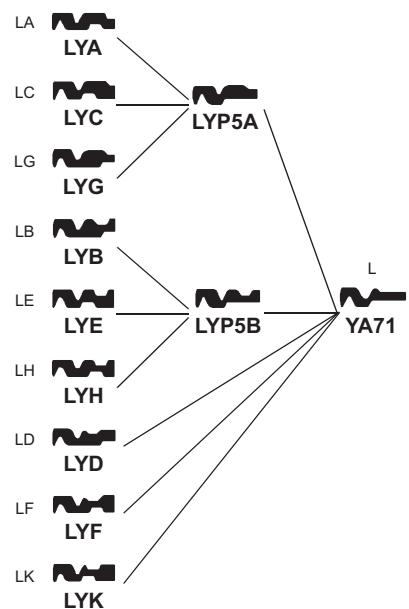
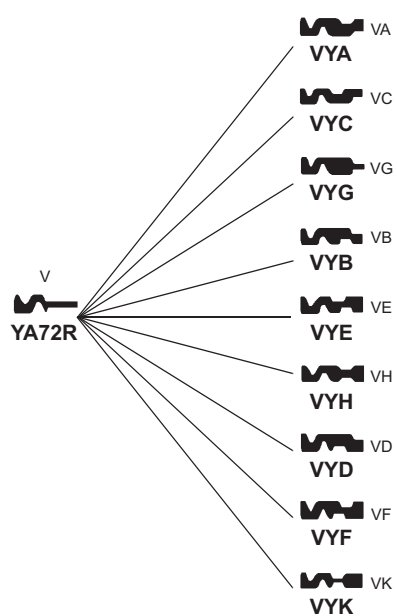
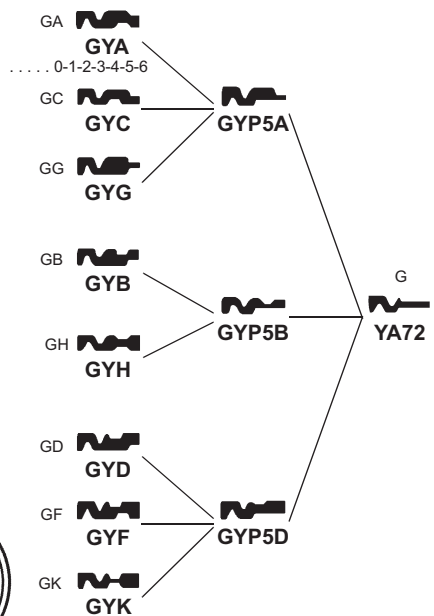



198

PER / FOR

YANMAR (J)

YARDENI (IL)

YEMAR (E)

UCEM (175)

YETI (PL)

FAB (74)

LOB (114)

MCM (121)

YETI (RC)

AKIRA
ASIA
BEDI
BELL
DEHA
FOUR-CIRCLE
HAIDE
HEAD
HEMY
HERMES
LOTUS
RAM
ROYAL
SANCHUN
SEZAN
SWAN
VELO
VISO
WINFIELD

PER: **YANMAR**

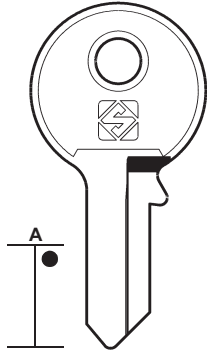

YAR1



YARDENI

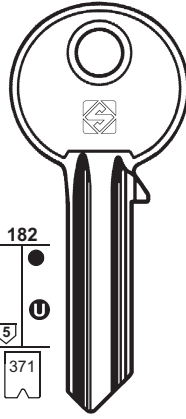

YD1 ▲**YD1R**
..... 0-1-2-3-4-5-6-7-8-9

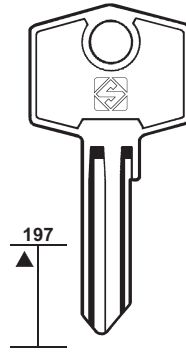

YD2 **YD2R**

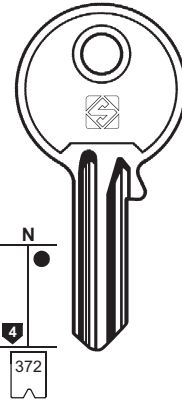

YD4 **YD4R** ▲

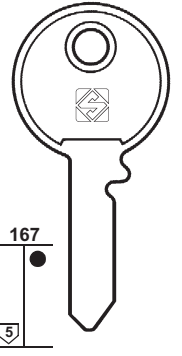

YD5R



PER:
FOR:

YARDENI

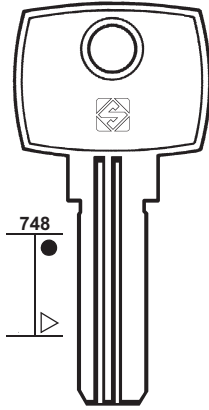

YD3R

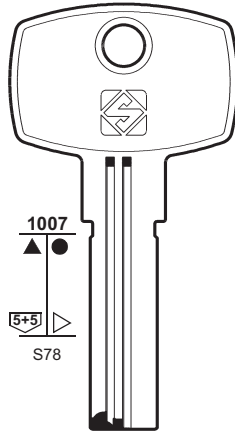

YD6R

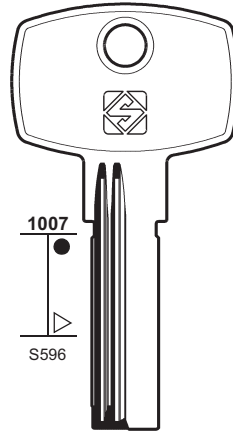

YD7R

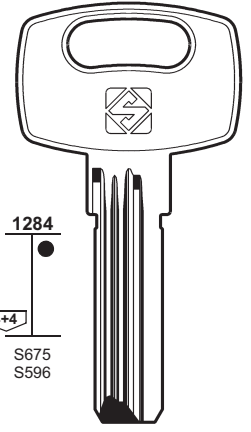

YD13R **YD14R**
XL 6



PER:
FOR:

YETI

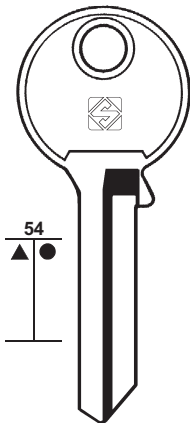

YT6 **YT6R**

●**YT12** **YT12R** ▲

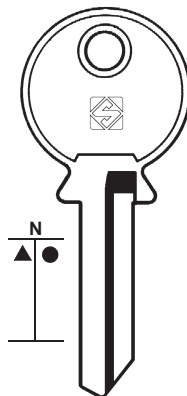

YT7 **YT7R**

YT13 **YT13R**

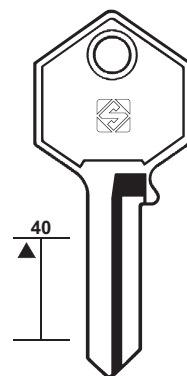

YT8 **YT8R**

●**YT14** **YT14R** ●

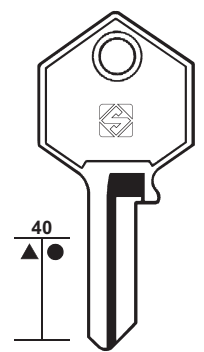

YT1 **YT1R**

▲**YT3** **YT3R** ▲

AKIRA - ASIA - BEDI - BELL - DEHA
FOUR-CIRCLE - HAIDE - HEMY - HERMES
HEAD - LOTUS - RAM - ROYAL - SANCHUN
SEZAN - SWAN - VELO - VISO - WINFIELD



mm 40

PER:
FOR:

YETI



277



12



215

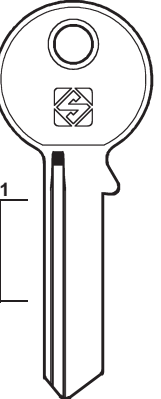

11

5

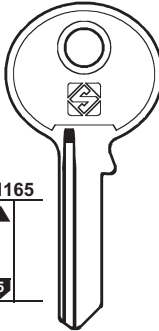

1165

5



YT9



YT9R



YT10



YT10R



●YT11



YT11R



YT2



▲YT2R



YT4



▲YT4R



●YT5



YT5R ●



YUH2R



YUH1R



mm 30



mm 25



mm 20

AKIRA - ASIA - BEDI - BELL - DEHA - FOUR-CIRCLE
HAIDE - HEMY - HERMES - HEAD - LOTUS - RAM - ROYAL
SANCHUN - SEZAN - SWAN - VELO - VISO - WINFIELD

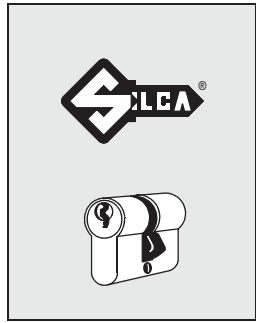

199

- PER / FOR**
- YETI (RC)**
AKIRA
ASIA
BEDI
BELL
BENCO
DEHA
FOUR-CIRCLE
HAIDE
HEAD
HEMY
HERMES
LOTUS
NOVA
RAM
ROYAL
SANCHUN
SEZAN
SWAN
VELO
VISO
WINFIELD
- YONGTAI (RC)**
TRI-CIRCLE (173)
- YUN HUAN (PRC)**
- YVEL (F)**
RICOUARD (146)
- ZADI (I)**
+ BRETER (34)

PER:
FOR:

ZADI (I)

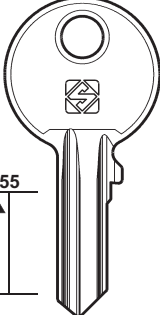

55

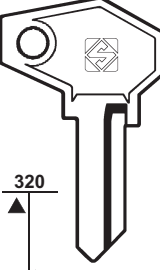

320

4

54
186

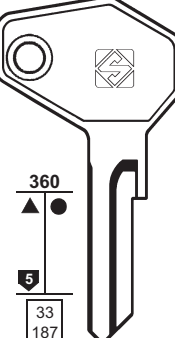

360

5

33
187
389

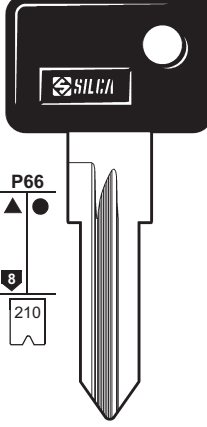

P66

8

210



ZD5



ZD5R



ZD4



ZD4R



ZD8

... 1-253



●ZD6

2 ... 1-624



ZD7

... 1-1625
... 9001-9500
E ... 1-500
E ... 501-710





ZD14RP

... 5001-6475
C ... 5001-6475









PER:
FOR:

ZADI (I)

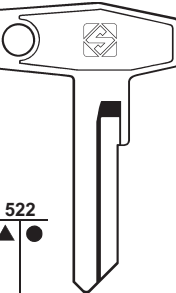

522

4 5

53
187
389

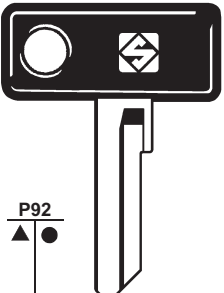

P92

4 5

53
187
389

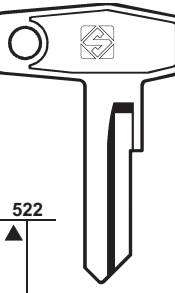

522

4

53
187
743
3205

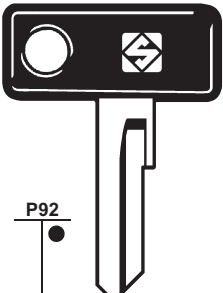

P92

4

53
187
743
3205



ZD9

... 1-1625
E ... 500
E ... 501-710
... 9001-9500
... 5001-6278



ZD9P

... 1-1625
E ... 500
E ... 501-710
... 9001-9500
... 5001-6278



ZD11

... 1-1625
E ... 1-500
... 5001-6278
E ... 501-710
... 1234
H ... 100-341





ZD11P

... 1-1625
E ... 1-500
... 5001-6278
E ... 501-710
... 1234
H ... 100-341











200

PER / FOR

ZADI (I)
BULLOCK
+ BRETER (34)

ZANETTI A. (I)
GHIDINI
OB
ROLEX
TAUB
TOR

ZANI (I)
BALLY
FIC
SINA
ZETA
+ ICSA (94)
+ MORI E. (129)

ZĚČĚ (HR)
CORBIN (53)

ZEISS IKON (D)
BRUMME
OTIS
+ BAB (26)
+ CORONA (55)

PER:
FOR:

ZADI

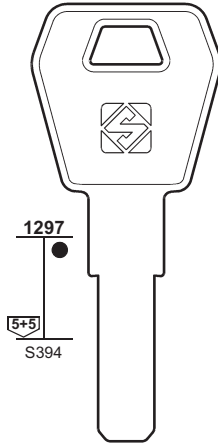

1297
5+5
S394



ZD25

BULLOCK

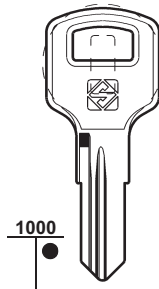

1000



ZD26R

ZANETTI ANGELO

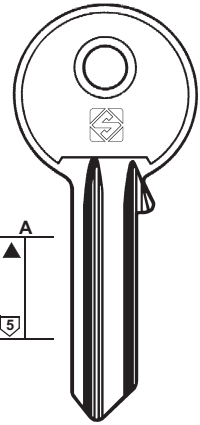

A
5



ZA2R

GHIDINI - OB - ROLEX - TAUB - TOR

PER:
FOR:

ZANI

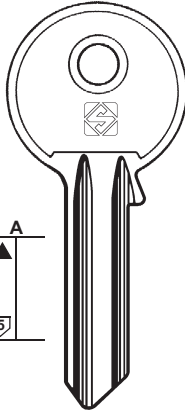

A
5



ZI1 ZI1R

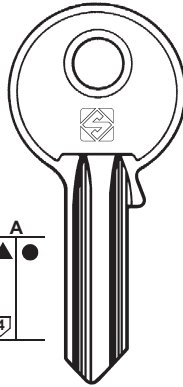

A
4



ZI2R

ZI4 ZI4R

BALLY - FIC - SINA - ZETA

BALLY

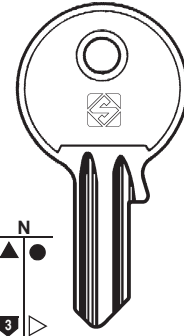

N
5



ZI3R

ZEISS IKON

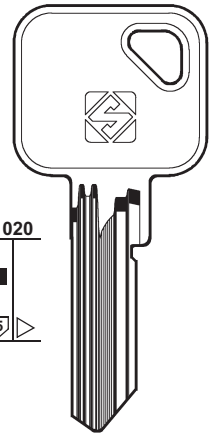

1020
5



ZE45

PER:
FOR:

ZEISS IKON

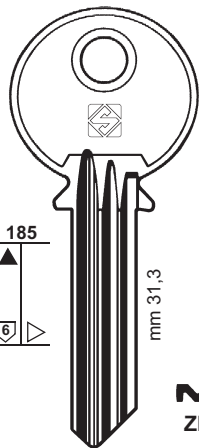

185
5

mm 31,3



ZE42



ZE14
ZC

ZE11
ZD



ZE14R
ZA

ZE11R
ZB

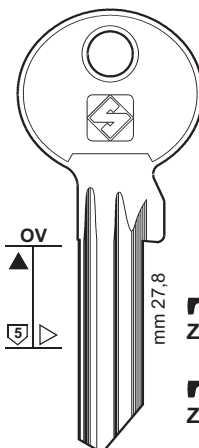

OV
5

mm 27,8



ZE34X SN1 ZE34RX SN2



ZE39X SN3 ZE39RX SN4



ZE40X SN5



ZE1X N1 ZE1RX N2

BRUMME - OTIS

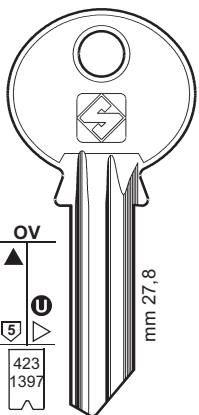

OV
5
423
1397

mm 27,8



ZE15 Z 461 ZE16 Z 484



ZE13 ZC ZE13R ZA



ZE10 ZD ZE10R ZB



ZE34 SN1 ZE34R SN2



ZE39 SN3



ZE1 N1 ZE1R N2

..... (TK5)
1-2-3-4-5-6-7-8-9-0
A-B-C-D-E-F-G-H-I-L
..... (TK6)
1-2-3-4-5-6-7-8-9-0
A-B-C-D-E-F-G-H-I-L

BRUMME - OTIS

PER:
FOR:

ZEISS IKON

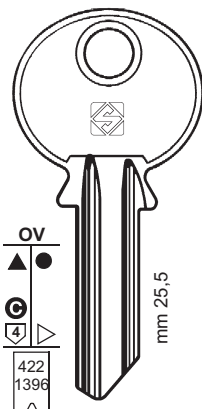

ZE2
N 11
.....(SK5)
1-2-3-4-5-6-7-8-9-0
A-B-C-D-E-F-G-H-I-L

BURG

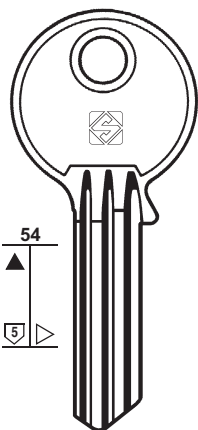

ZE12
M

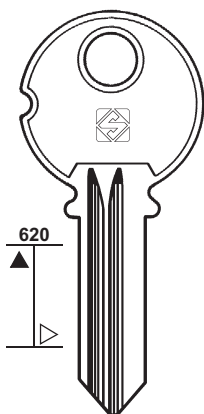

ZE30 **ZE30R**
DS2 DS1

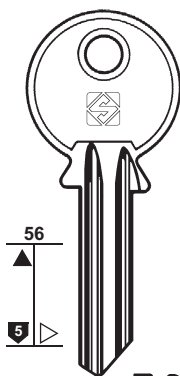

ZE5
K5



ZE4
K3



ZE3
K1

ZE5R ▲ ●
K60

ZE7



ZE3R
K2



CORONA - FORTSCHRITT



201

PER / FOR

ZEISS IKON (D)
BURG
CORONA
FORTSCHRITT
+ BAB (26)
+ CORONA (55)

ZENI (GB)

ZENICA (F)

ZENITH (F) (I)
ARNOV
AUBERT
FO
MONOBLOC
QCP
SIAM
SICMA
+ CITY (51)
+ SIS (155)

ZETA (I)

ZANI (200)

PER:
FOR:

ZENI

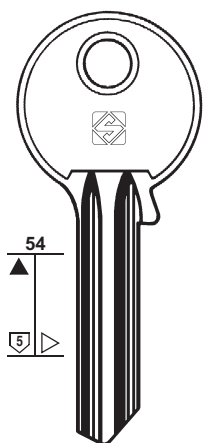

ZN1

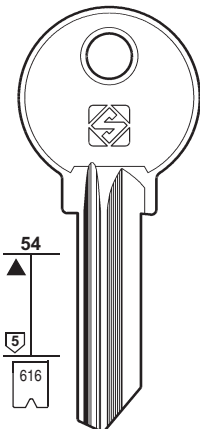

CA14 **CA8** ▲ ●
170000-176310
..... 0123456

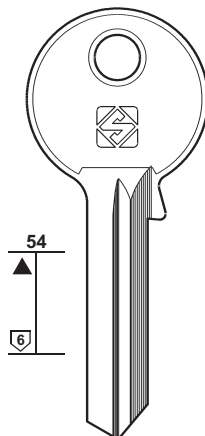

CA13

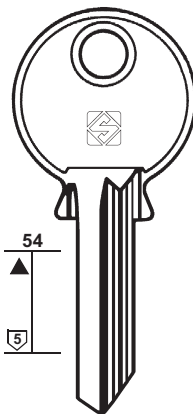

CA12

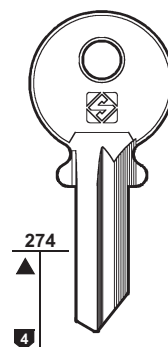

CA6

PER:
FOR:

ZENITH (F)

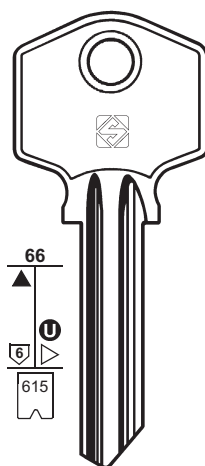

CA11

..... 0123456
..... 400001-435886

AUBERT - FO

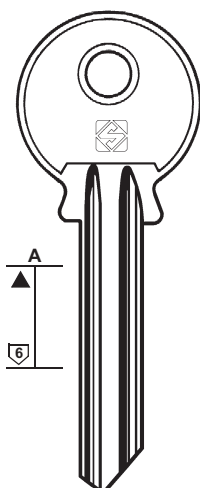

CA10 **CA10R**

ARNOV
FO - MONOBLOC

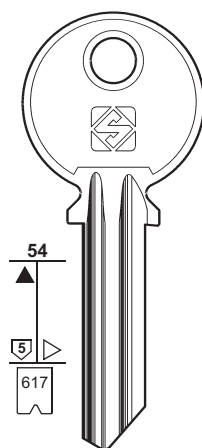

CA15
..... 81000-88179

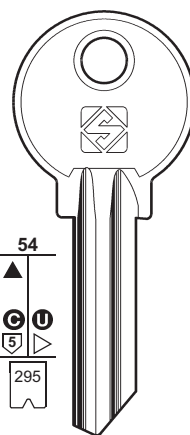

CA2R **CA2**

160 ... 000-999
16 ... 1000-6288

QCP - SIAM

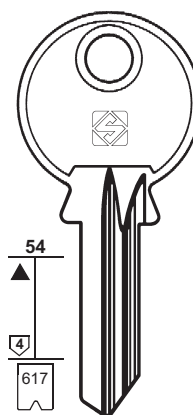

CA7

..... 0-1-2-3-4-5-6
..... 12500-15949

SICMA



202

PER / FOR

ZHONGHENG (PRC)

PER:
FOR:

ZHONGHENG

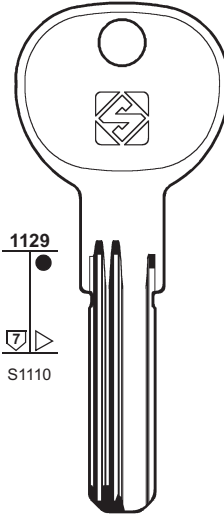

ZH1R



PER:
FOR:

PER:
FOR: