

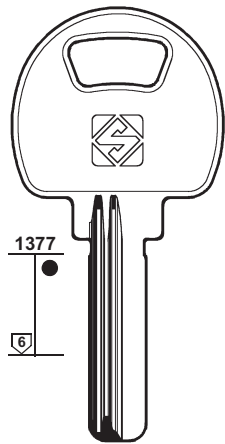

Dimple Keys  
Chiavi punzonate  
Bohrmuldenschlüssel  
Clés à points  
Llaves de seguridad  
Chaves de pontos



PER:  
FOR: **3M**



1377  
6

**TRM1R**

**ABUS**

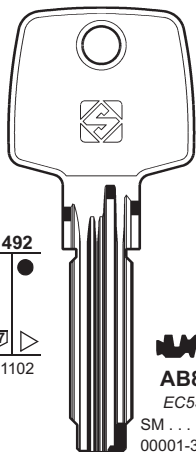

1492  
6+7  
S1102

**AB74**  
D6

**AB84**  
EC550  
SM. ....  
00001-30000

**AB77**  
D8

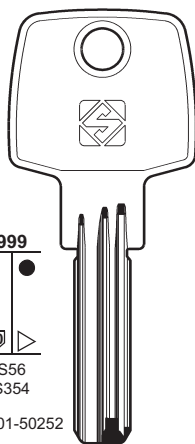

999  
10

**AB40**  
AAL

S56  
S354  
- 00001-50252

EXTRA-CLASSE

CISA - BRICARD

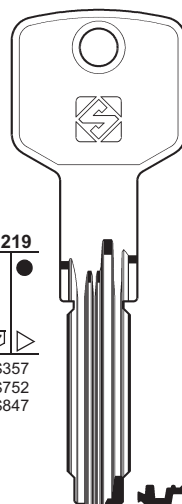

1219  
6+7  
S357  
S752  
S847

**AB48**  
D6

..... 000001-168000  
- 00001-50252  
..... (XN005710) 1-38832

NEW ASTRAL

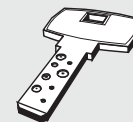

**205**

PER / FOR

**3M** (PRC)

**ABUS** (D)  
CISA  
BRICARD  
+ CISA (207)

**AGA** (E)  
CASAS  
COLOMENCA  
FB  
SERRALLER  
TERCA

**AGB** (I)

PER:  
FOR: **ABUS**

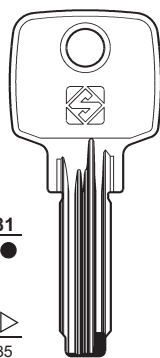

1481  
5  
S635  
S846

**AB62**  
EC75

..... 00001-10000  
D8 ..... 0000-9999

mm 30-40-50

**AGA**

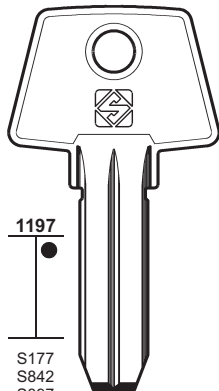

1197  
S177  
S842  
S897  
S898  
S972

**AGA7**

COLOMENCA - FB  
SERRALLER - TERCA

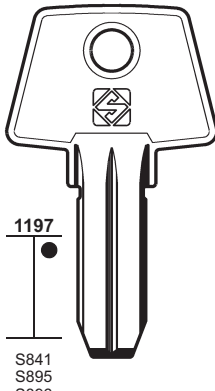

1197  
S841  
S895  
S896

**AGA9**

CASAS

**AGB**

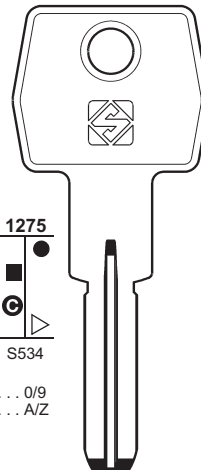

1275  
S534  
..... 0/9  
..... A/Z

**AGB5**

SCUDO 9000

PER:  
FOR: **AGB**

**AGB**

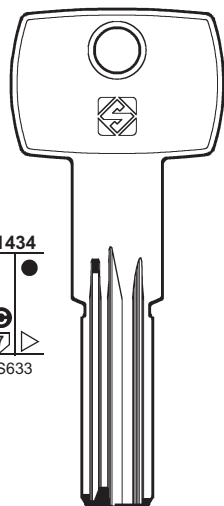

1434  
C  
7  
S633

**AGB8**

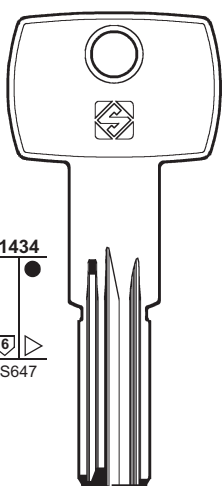

1434  
6  
7  
S647

**AGB9**

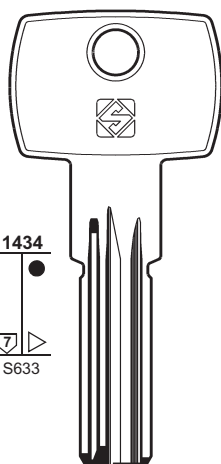

1434  
7  
S633

**AGB6**  
SCUDO 7000

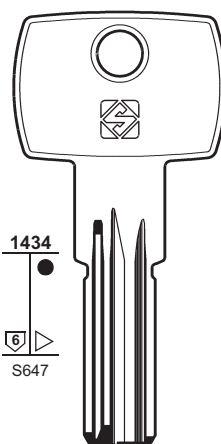

1434  
6  
S647

**AGB7**  
SCUDO 5000

SCUDO

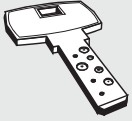

# 206

PER / FOR

AGENT (J)

ALA (I)  
KESO (215)

AL AHRAM (ET)

ALPHA (I)

AMIG (E)

APEKS (RUS)

ATRA (I)  
ISEO (214)

AZBE (E)  
CAVERS

BAODEAN (PRC)

BASI (D)  
SATURN (220)

BEY (TR)

BLINKY (PRC)

BÖRKEY (D)  
KABA (214)

PER: FOR:	AGENT	AL AHRAM	ALPHA	AMIG
	 1006 S727	 1514	 1121	 1026
	 AGN1	 AHR2	 ALP16	 AMG1R

PER: FOR:	APEKS		AZBE		
	 1026 S798	 1026	 1054 S51 S84 S480 S481 5+4+4	 1054 S166 S167	 1198
	 APK2R	 APK3R	 AZ6 HS-4	 AZ6R HS-6	 AZ7 HS-6
			CAVERS	CAVERS	

PER: FOR:	BAODEAN	BEY		BLINKY
	 1577	 1130	 1577	 1346
	 BAE1	 BEY1R	 BEY2R	 BNK1

PER:  
FOR:

# BRICARD

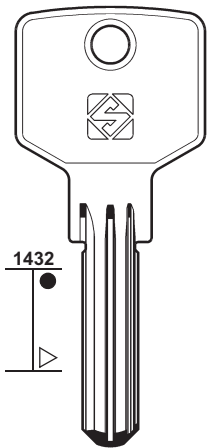

1432

..... 000001-049000  
..... 050000-106238



BD11 BD14

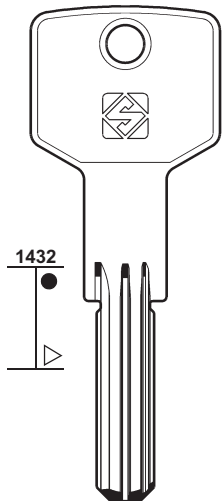

1432



BD11X BD14X

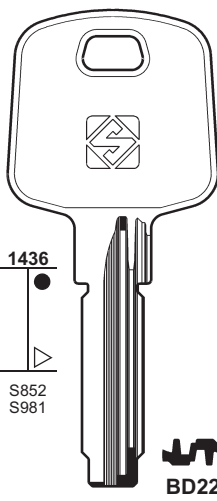

1436

S852  
S981



BD13 BD21  
Z75 Z76



BD22

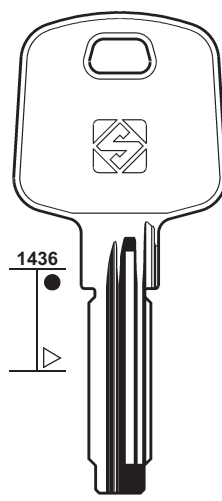

1436



BD16

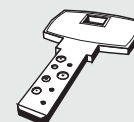

# 207

PER / FOR

**BRICARD (F)**  
+ ABUS (205)  
+ CISA (207-208)

**BSS (SRB)**  
URBIS (222)

**BULAT (PRC)**

**BULLOCK (I)**  
ZADI (224)

**BURG (D)**

**CASAS (E)**  
AGA (205)

**CAS-CISMA (I)**

**CAVERS (F)**  
AZBE (206)  
SPIDER (220)

**CAYS (E)**

**CES (D)**

**CIERRA SOLA (RA)**

**CISA (I)**  
ABUS  
BRICARD  
+ ABUS (205)

PER:  
FOR:

# BULAT

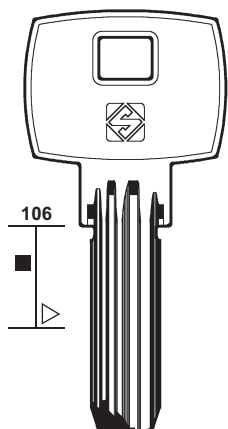

106



BUT1R

# BURG

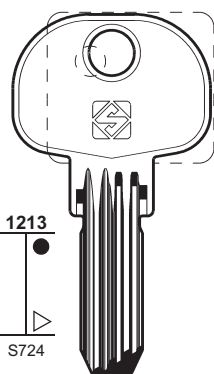

1213

S724



BUR27  
75W



mm 30-40

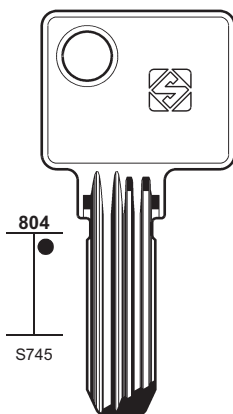

804

S745



BUR33  
76W



mm 50-60

# CAS-CISMA

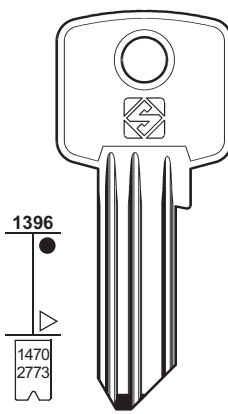

1396

1470  
2773



CIS9

..... 12345678AB



CIS12

..... 12345678

PER:  
FOR:

# CAYS

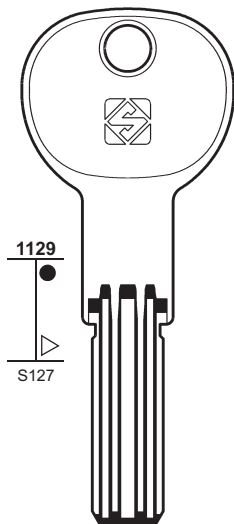

1129

S127



CYS2

# CES

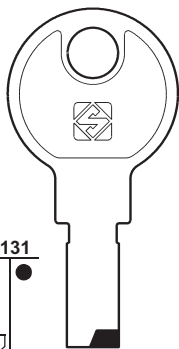

1131

S914

MS... 1-20



CE131

# CIERRA SOLA

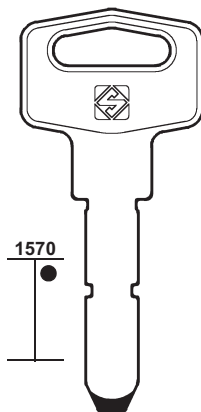

1570



CRL1

# CISA

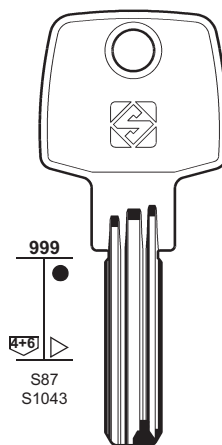

999

4+6

S87  
S1043



CS48

A/Z A/Z A/Z .....  
000001-030198

ABUS - BRICARD



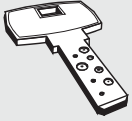

208

PER / FOR

CISA (I)  
BRICARD  
+ ABUS (205)

CITY (F)  
ISEO (213-214)

CODEM (F)  
FTH (212)

CODKEY (IL)  
SPIDER (220)

COLOMENCA (E)  
AGA (205)

CORBIN (I)  
+ DOM (209-210)

CVL (E)

DAF (TR)

DECAYEUX (F)  
PICARDIE (219)

DEFEND LOCK (CZ)

PER:  
FOR:

CISA

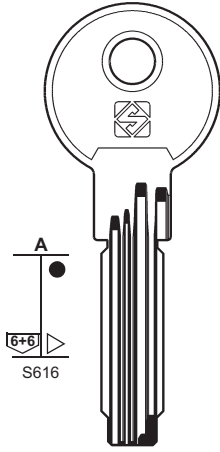

ASIX

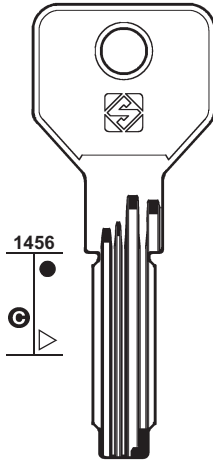

ASIX

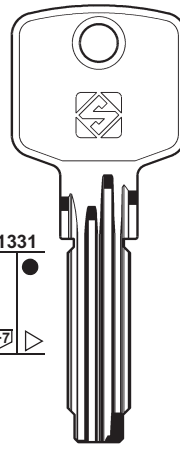

NEW ASTRAL

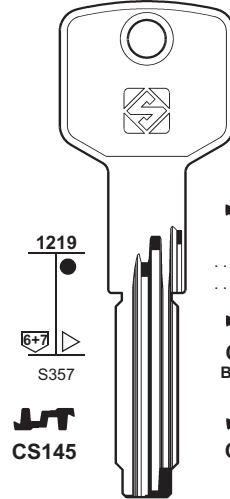

NEW ASTRAL

(W08)  
CS62 (XN008710) 1-11808  
(XN005710) 1-38832

(W05)  
CS115 BRICARD



CS140

PER:  
FOR:

CISA

CORBIN (I)

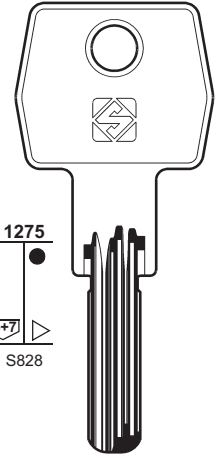
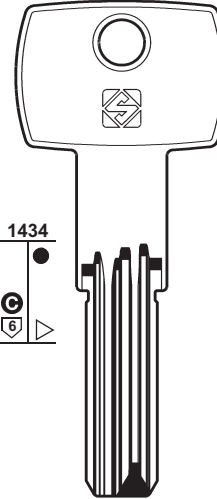
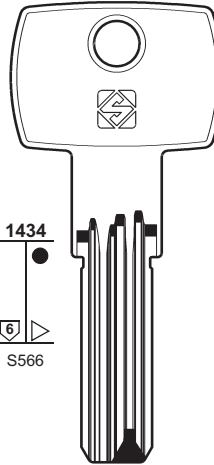
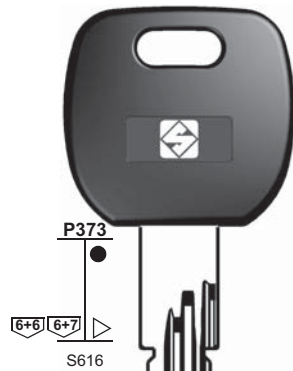

EURO STAR PLUS

PER:  
FOR:

CVL

DAF

DEFEND LOCK

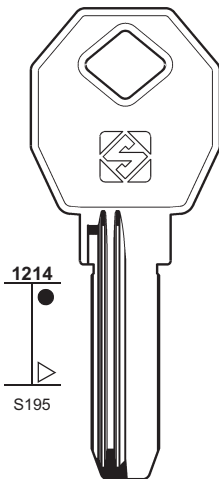

IC 8-7-6-5-4-3

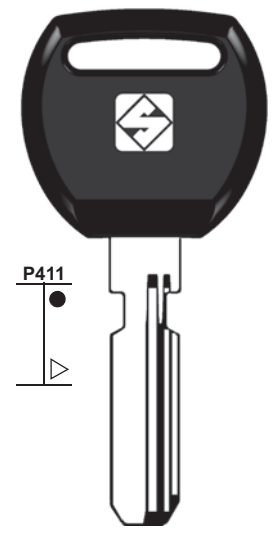
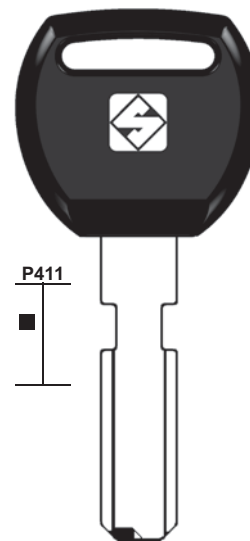
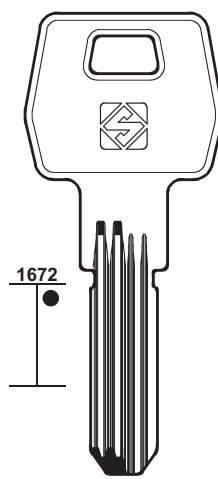

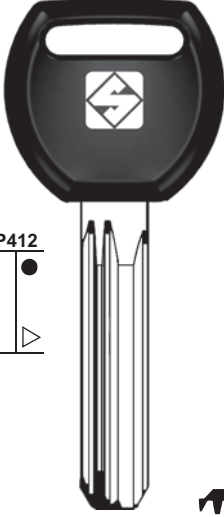
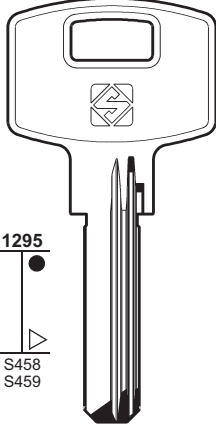
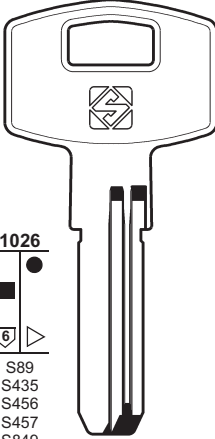
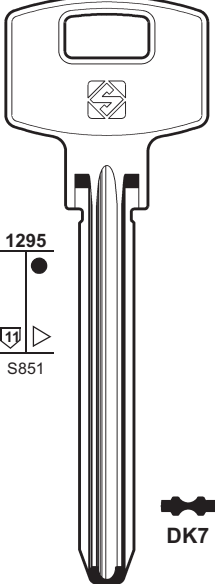
<p>PER: FOR:</p> <p><b>DEFEND LOCK</b></p>	<p><b>DEKABA</b></p>		
 <p>P412</p> <p>DFE3RAP</p>	 <p>1295</p> <p>S458 S459</p> <p>DK1</p> <p>MAUER</p>	 <p>1026</p> <p>S89 S435 S456 S457 S849</p> <p>DK3 E2</p> <p>MAUER</p>	 <p>1295</p> <p>S851</p> <p>DK7</p> <p>MAUER</p>



209

PER / FOR
<b>DEFEND LOCK</b> (CZ)
<b>DEKABA</b> (BG) MAUER
<b>DELCA</b> (GR) GEVY
<b>DIAM</b> (F) LAPERCHÉ (216)
<b>DIERRE</b> (I)
<b>DOM</b> (D) CORBIN EMHART IR LAPERCHÉ

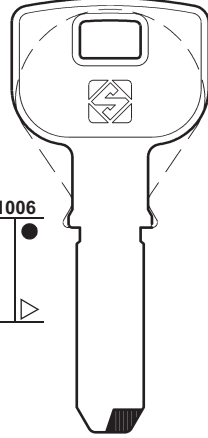
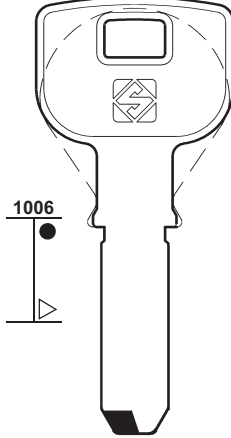
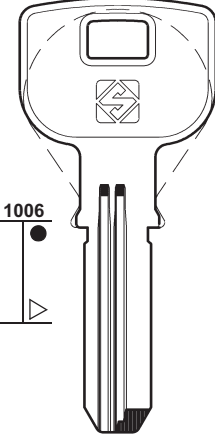
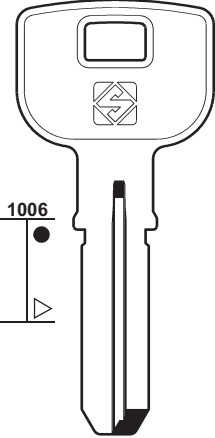
<p>PER: FOR:</p>	<p><b>DELCA</b></p>		
 <p>1006</p> <p>DLC1</p>	 <p>1006</p> <p>DLC1R</p>	 <p>1006</p> <p>DLC2R</p>	 <p>1006</p> <p>DLC3</p>
GEVY		GEVY	

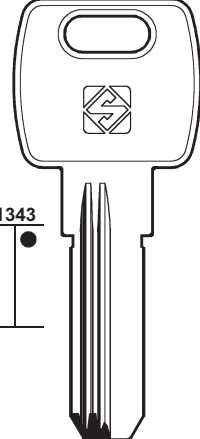
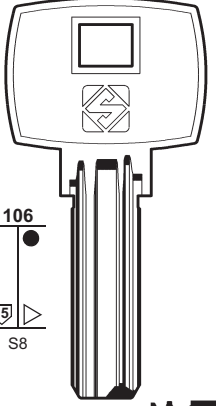
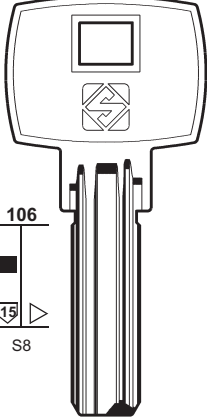
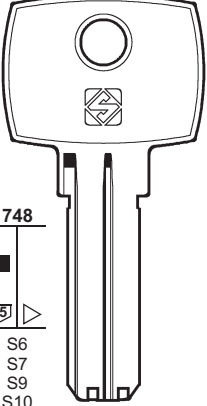
<p>PER: FOR:</p>	<p><b>DOM</b></p>		
 <p>1343</p> <p>DIR1R</p>	 <p>106</p> <p>S8</p> <p>DM64</p>	 <p>106</p> <p>S8</p> <p>DM120</p> <p>DM122</p>	 <p>748</p> <p>S6 S7 S9 S10 S45 S118 S178</p> <p>DM49</p> <p>DM53</p>
CORBIN - EMHART IR - LAPERCHÉ		CORBIN	

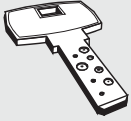

# 210

### PER / FOR

**DOM (D)**  
CORBIN  
EMHART  
MOREAUX  
STS

**DOMUS (GR)**

**DORSET (IND)**  
KABA (214)

**ELCA (D)**  
STS  
TESA  
VIRO

**ELZETT (H)**

**EMHART (USA)**  
DOM (209-210)

**ESAFE (E)**  
UCEM (222)

PER:  
FOR:

## DOM

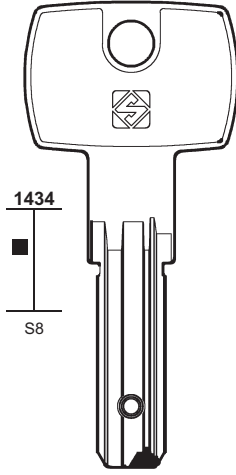

1434  
S8

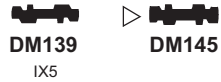

DM139 IX5    DM145

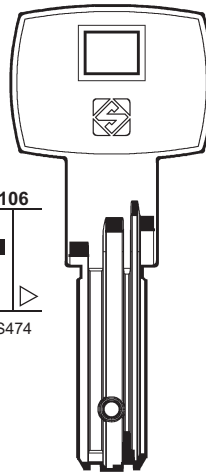

106  
S474



DM144 IX6

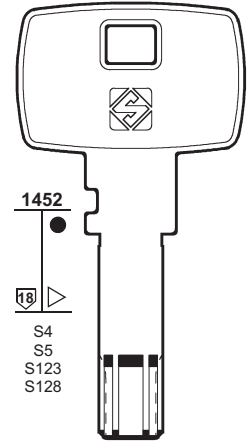

1452  
S4  
S5  
S123  
S128



DM22TVPX    DM22TV5X

STS

PER:  
FOR:

## DOM

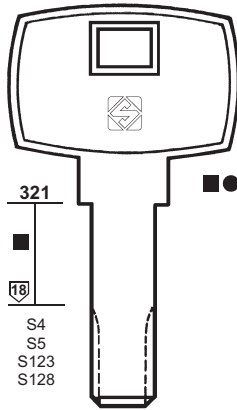

321  
S4  
S5  
S123  
S128



DM22



DM22TV5    DM22TV10



DM22TV4    DM22TV9



DM22TV3    DM22TV8



DM22TV2    DM22TV7



DM22TV1    DM22TV6



DM22TVP

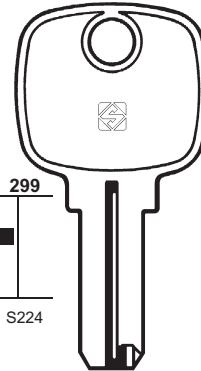

299  
S224



DM21  
..... 0-1-2-3-4-5

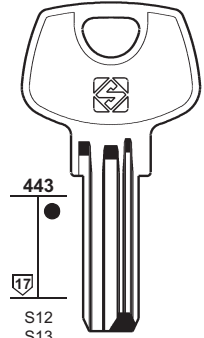

443  
S12  
S13



DM138



DM55  
2Y



ALARM

CORBIN - EMHART

MOREAUX

PER:  
FOR:

## DOM

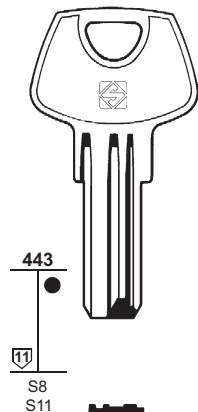

443  
S8  
S11



DM128



DM58



ALARM

## DOMUS (GR)

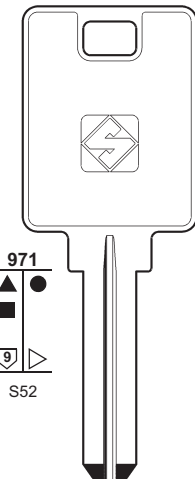

971  
S52



DS6    DS7

## ELCA

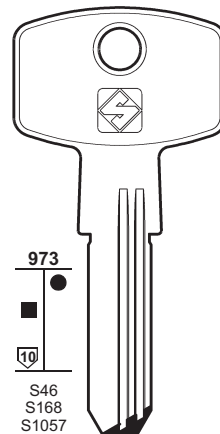

973  
S46  
S168  
S1057



EC5

## ELZETT

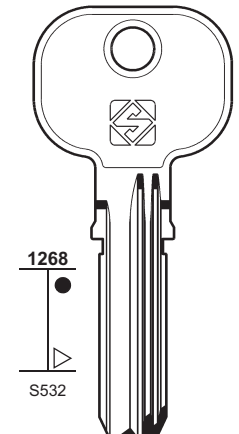

1268  
S532

.....  
0-1-2-3-4



EL9

STS - TESA - VIRO



PER: **EURO LOCKS**  
FOR:

**EZCURRA**

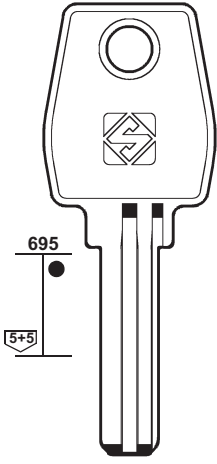

**EU17**

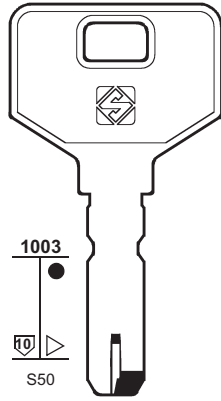

**EZ3**  
DS10

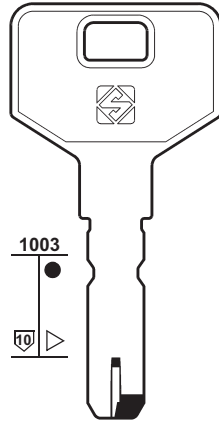

**EZ3X**  
DS10

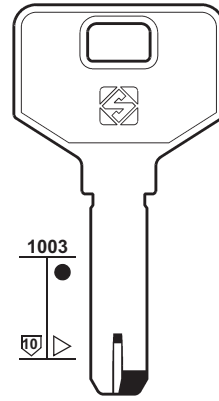

**EZ6**  
DS15

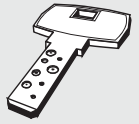

**211**

PER / FOR  
**EURO LOCKS (B)**

**EZCURRA (E)**  
+ SEA (220)

**FAC (E)**

**FAVOUR (DZ)**

PER:  
FOR:

**EZCURRA**

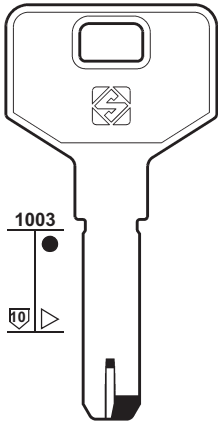

**EZ6X**  
DS15

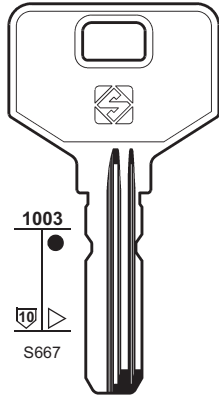

**EZ4**  
DS10-E

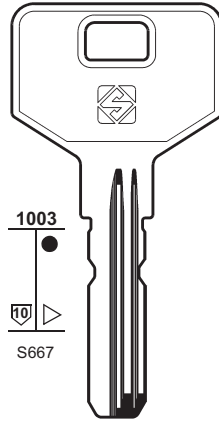

**EZ4X**  
DS10

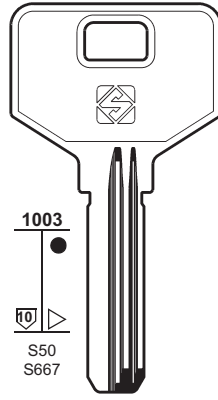

**EZ5**  
DS15-E

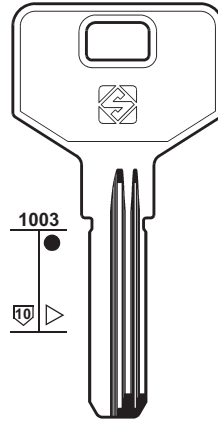

**EZ5X**  
DS15

PER:  
FOR:

**FAC**

**FAVOUR**

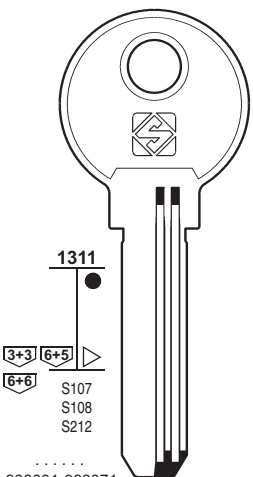

S107  
S108  
S212  
.....  
900001-963071

**FAC15**

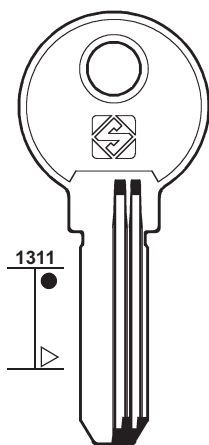

**FAC31**

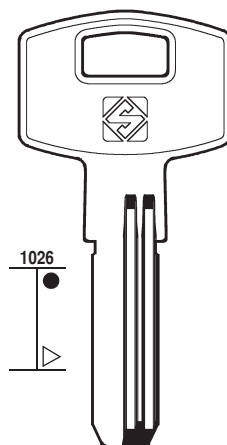

**FVR1**

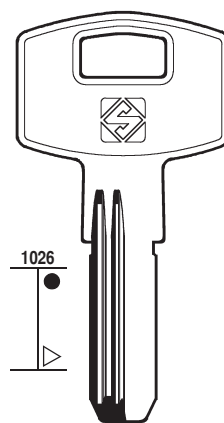

**FVR2R**

**FVR4R**

**FVR3**

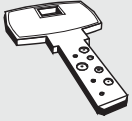

# 212

PER / FOR

**FAYN** (TR)

**FB** (E)

👁️ AGA (205)

**FCV** (D)

KFV

VBH

**FEB** (I)

👁️ VIRO (223)

**FIAM** (I)

+ 👁️ KESO (215)

**FTH** (F)

CODEM

GOTTA

IFAM

ITO

KARO

SP

TOVER

YALTRES

**GARRISON** (GB)

👁️ MUL.T.LOCK (218)

PER:  
FOR: **FAYN**

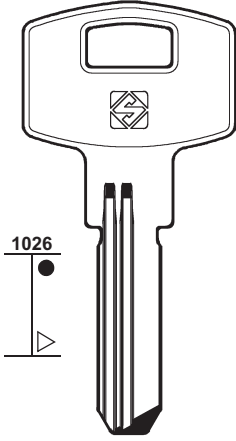

1026

**FY1R**

**FCV**

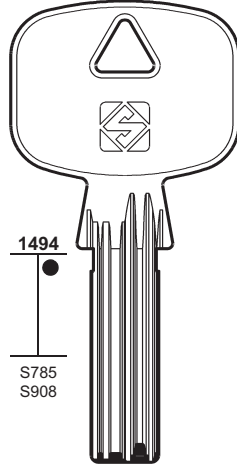

1494  
S785  
S908

**FV4**

KFV - VBH

**FIAM**

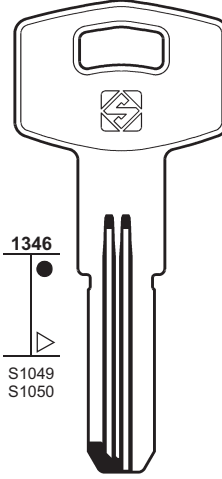

1346  
S1049  
S1050

**FI3R**

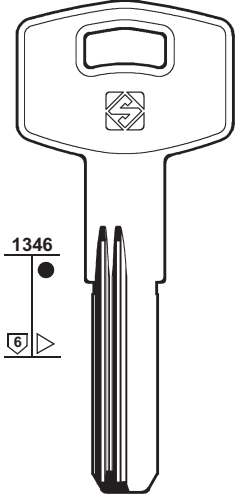

1346  
6

**FI4R**

PER:  
FOR:

**FTH**

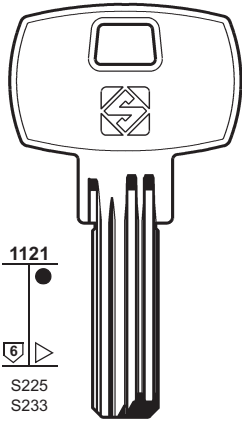

1121  
S225  
S233

**FH12**

CODEM - GOTTA - ITO  
TOVER - YALTRES

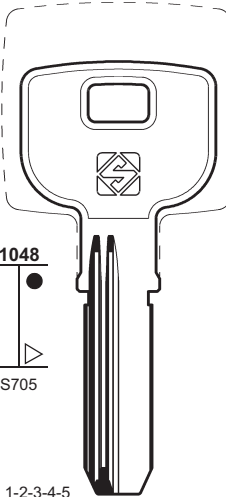

1048  
S705

..... 1-2-3-4-5

**FH17R**

IFAM - KARO

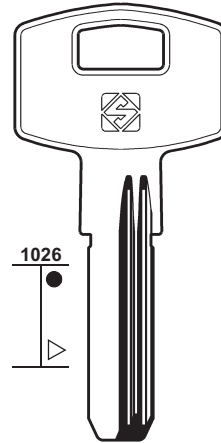

1026

**FH32**

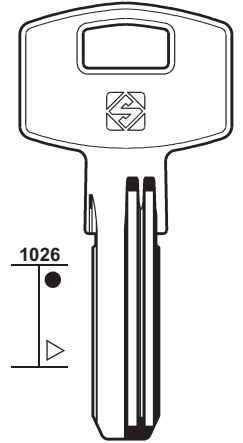

1026

**FH33**

SP

PER:  
FOR:

**FTH**

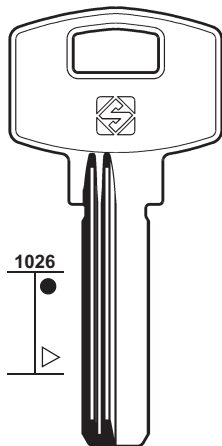

1026

**FH34R**

SP

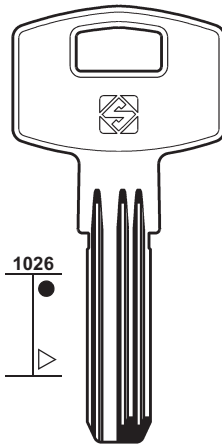

1026

**FH35**

SP

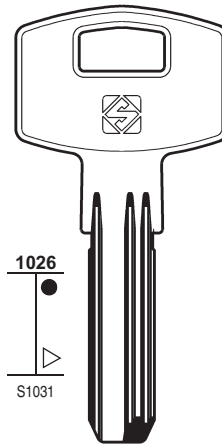

1026  
S1031



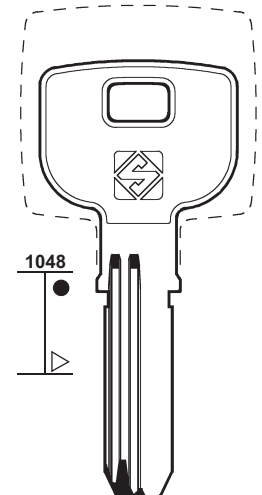



**FH36**

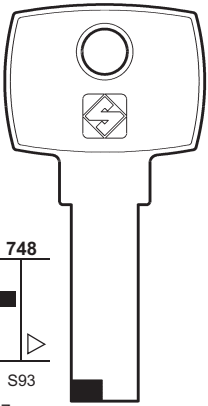
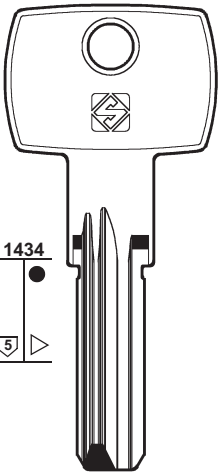
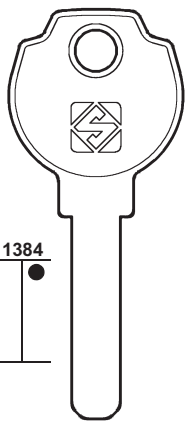
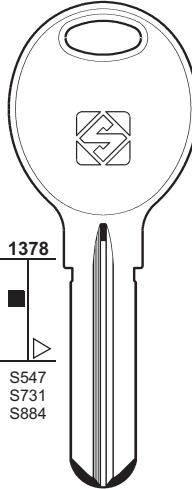
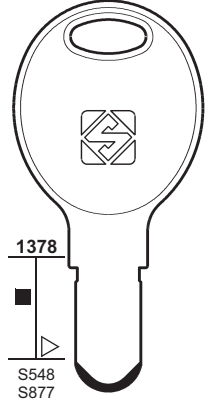

1048







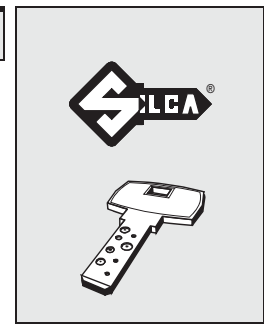

**FH37R**





SP



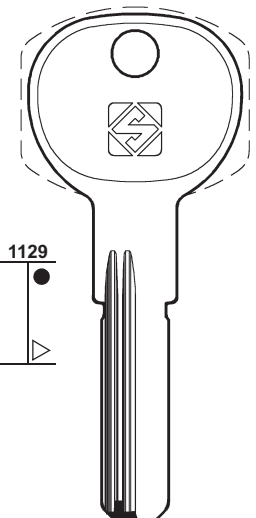
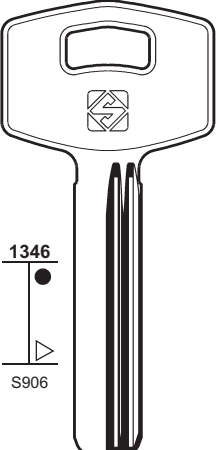
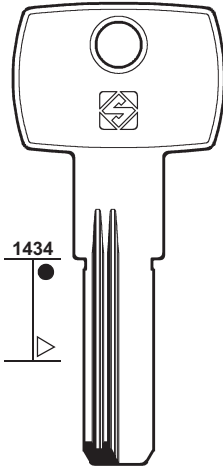
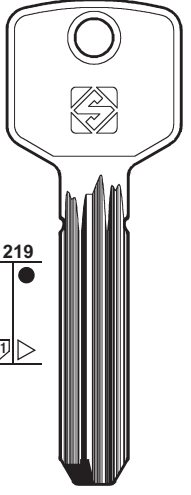

PER: FOR:	GEGE	GEVY	GIUSSANI	GOAL
				 
	748 S93 Z... 101-120	1434 5	1384	1378 S547 S731 S884 1378 S548 S877
	 GE57	 GVY1R	 GS17	 GO6  GO7
		MOTTURA		

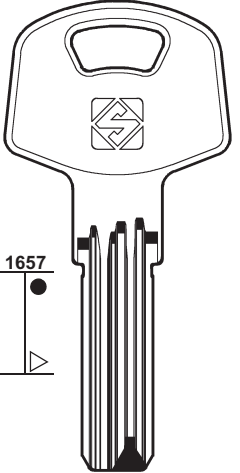
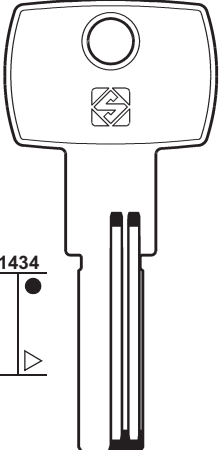
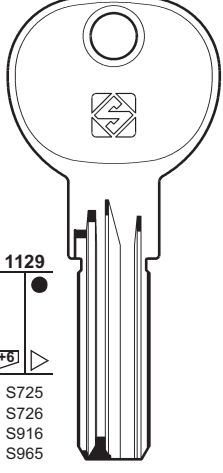
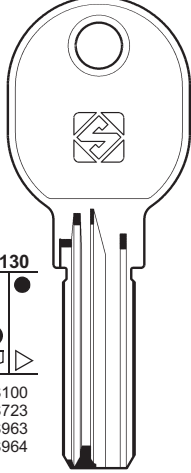

# 213

PER / FOR
GEGE (A)
GEVY (GR) MOTTURA +  DELCA (209)
GIUSSANI (I)
GOAL (J)
GOTTA (D)  FTH (212)
GP (I)
GRIFO (RC)
HASLER (D)  SEA (220)
HB (I)  LEGALLAIS (216)
HOK (TR)
HOOPLY (PRC)  WANJIN (223)
HUGO (D)
ICSA (I)  LINCE (216)
IFAM (E)  FTH (212)
I.R. (F) +  DOM (209)
ISEO (I) CITY VACHETTE +  UCEM (222)

PER: FOR:	GP	GRIFO	HOK	HUGO
				
	1129	1346 S906	1434	1219
	 GPI1	 GF1	 HOK1R	 HGO1R

PER: FOR:	IFAM	I.R.	ISEO
			 
	1657	1434	1129 S725 S726 S916 S965 1130 S100 S723 S963 S964
	 IF14	 IR1	EDL ..... CFA ..... 1-27065 EDL ..... 1-350589  IE14 R11 ABL ..... 1-015328 ACY ..... 1-015328 AGL ..... 1-015328 ABF ..... 1-015694  IE15 R6
			CITY - VACHETTE

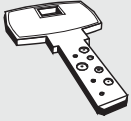

# 214

### PER / FOR

#### ISEO (I)

ATRA  
CITY  
+ UCEM (222)

#### ITO (TR)

+ FTH (212)

#### JPM (F)

+ KESO (215)

#### KABA (CH)

BÖRKEY  
DORSET  
LÄSBOLAGET  
PICARD

#### KAKEN (ROK)

PER:  
FOR:

## ISEO

## ITO

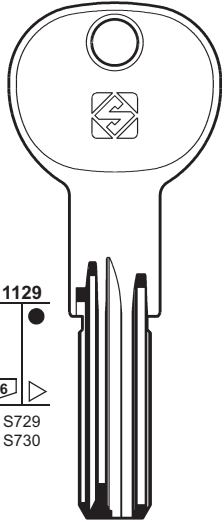

1129  
5+6+6  
S729  
S730

AAC ..... 1-015694  
DAA ..... 1-348933



**IE26**

ATRA - CITY

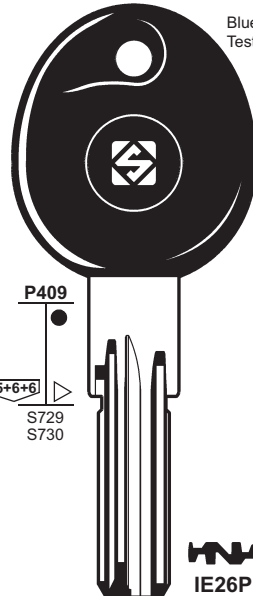

Blue head  
Testa blu

P409  
5+6+6  
S729  
S730



**IE26P**

AAC ..... 1-015694  
DAA ..... 1-348933

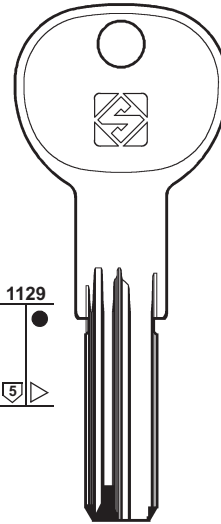

1129  
5  
S729  
S730



**IE30**

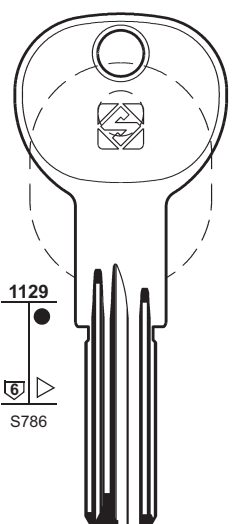

1129  
6  
S786



**IO1**

PER:  
FOR:

## KABA

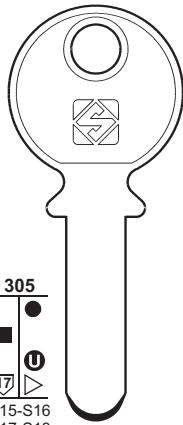

305  
S15-S16  
S17-S18  
S53-S58  
S59-S61  
S114

PH . . . . .  
0001-9000  
... 1-200

**KA1** mm 2  
8

LÄSBOLAGET

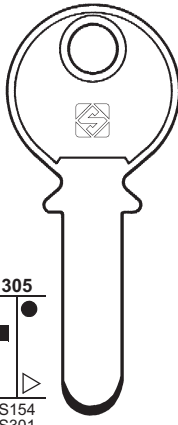

305  
S154  
S301  
S304  
S483

**KA2** mm 2,5  
20

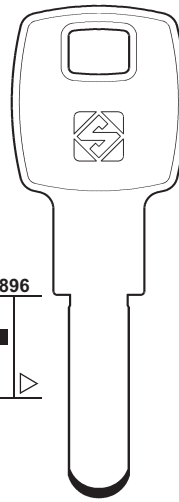

896

**KA7** mm 2,5

PICARD

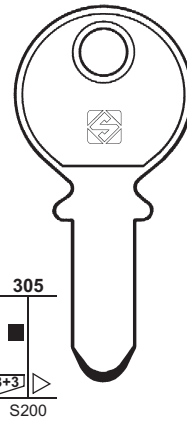

305  
3+3+3  
S200

**KA6**

BORKEY

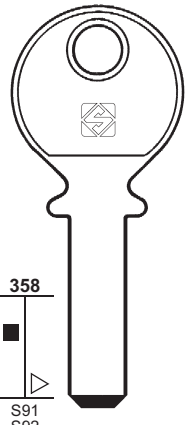

358  
S91  
S92

**KA3**  
MINI KABA

PER:  
FOR:

## KABA

## KAKEN

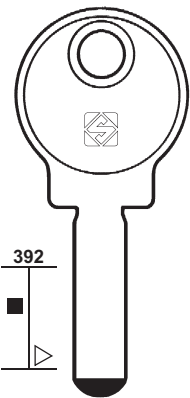

392

**KA4**

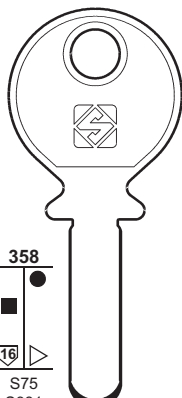

358  
16  
S75  
S381  
S384  
S387

**KA5**  
GEMINI

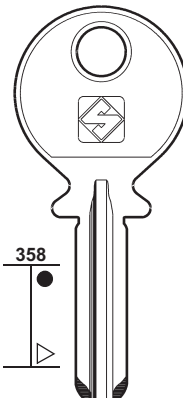

358

**KA9**

DORSET

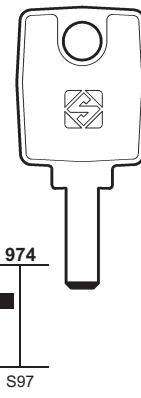

974  
S97

**KA8**  
MICRO KABA

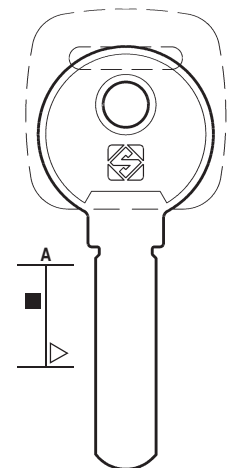

A

**KAK1**

PER:  
FOR:

# KALE

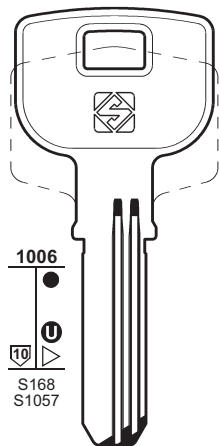

1006  
S168  
S1057

**KLE1**   **KLE4**

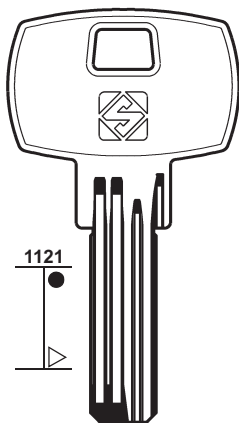

1121

**KLE2R**

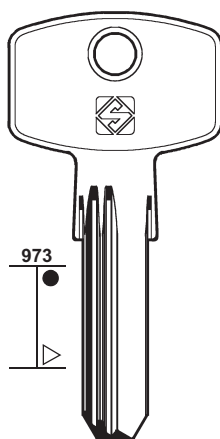

973

**KLE8R**

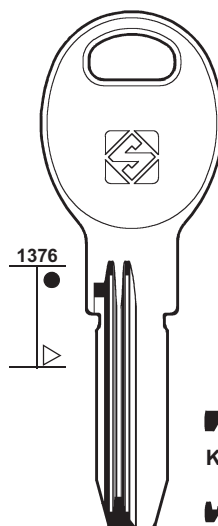

1376

**KLE9R**  
**KLE10R**

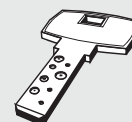

# 215

PER / FOR

**KALE** (TR)  
+ TESA (221)

**KARO** (E)  
 FTH (212)

**KESO** (CH)  
ALA  
FIAM  
JPM  
LIPS  
SARGENT

**KFV** (D)  
 FCV (212)

**IMSI** (I)  
 PERINO PG (219)

**JPM** (F)  
 KESO (215)

PER:  
FOR:

# KESO

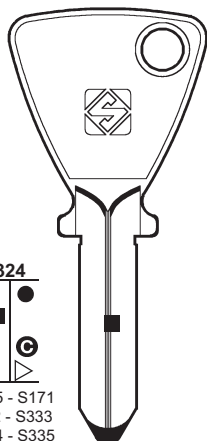

324  
S105 - S171  
S332 - S333  
S334 - S335  
S336 - S598  
S599 - S600  
S601 - S678  
S807

**KE1**

JPM

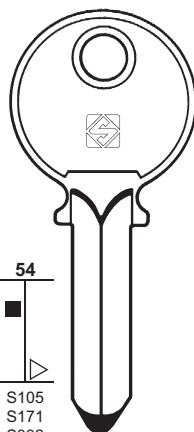

54  
S105  
S171  
S332  
S333  
S334  
S335  
S336  
S598  
S599  
S600  
S601

**KE2**

JPM

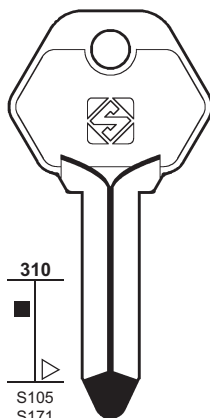

310  
S105  
S171  
S332  
S333  
S334  
S335  
S336  
S598  
S599  
S600  
S601

**KE4**

SARGENT

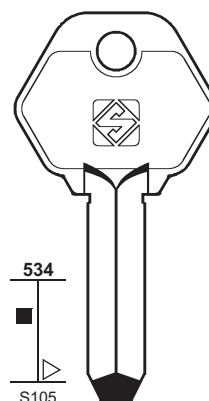

534  
S105

**LP11**

LIPS

PER:  
FOR:

# KESO

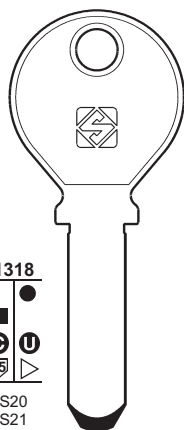

1318  
S20  
S21  
S57  
S267  
S273  
S277  
S359

**KE3**

ALA

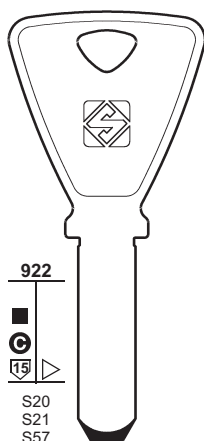

922  
S20  
S21  
S57  
S267  
S273  
S277  
S359  
S663

**KE9**

JPM

2000

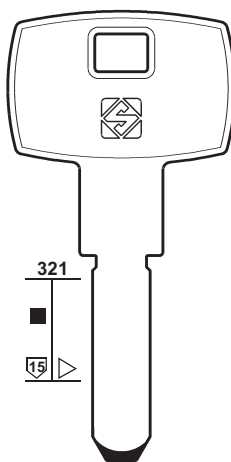

321

**KE11**

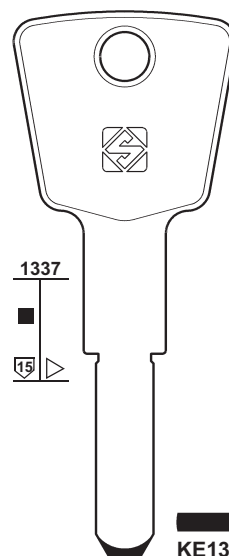

1337

**KE13**

FIAM

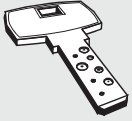

# 216

**PER / FOR**

**LAPERCHE (F)**

DIAM  
+ DOM (209)

**LÅSBOLAGET (S)**

KABA (214)

**LEGALLAIS (F)**

HB

**LINCE (E)**

ICSA

**LIPS (NL)**

+ KESO (215)

**LOB (PL)**

MCM (217)

**LOCKSYS (BG)**

**MAGNUM (GB)**

**MASTER (USA)**

+ TOVER (222)

**MASTER LOCK (PRC)**

**MAUER LOCKS (BG)**

DEKABA (209)

PER:  
FOR:

## LAPERCHE

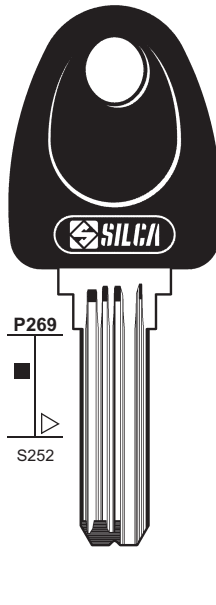
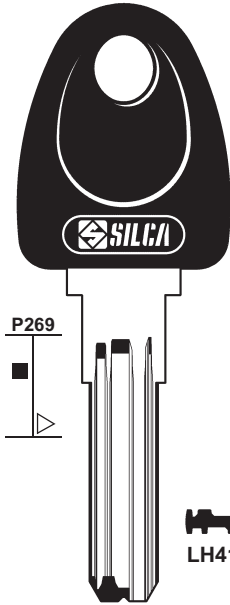

LH41P

DIAM



LH13P



LH14P



LH15P



LH16P



LH17P



LH18P

## LEGALLAIS

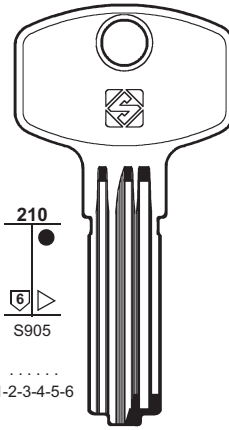

LEA1

HB

## LINCE

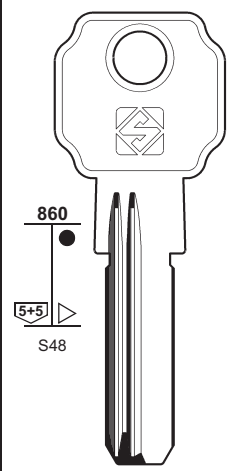

LC14R  
X

ICSA

PER:  
FOR:

## LIPS

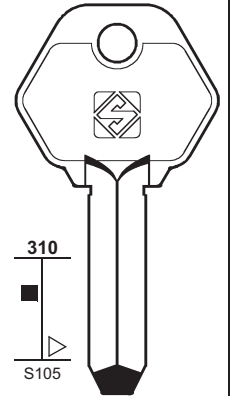

LP11

## LOCKSYS

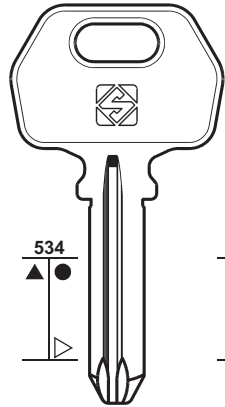

LCK1R

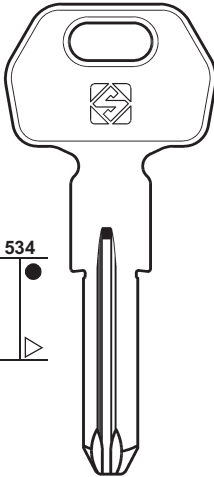

LCK1RX

## MAGNUM

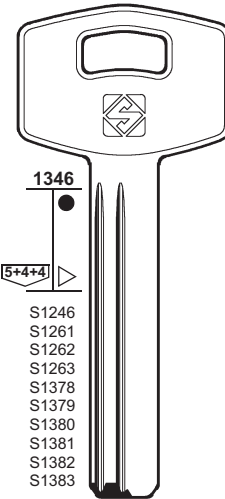

MGN1R

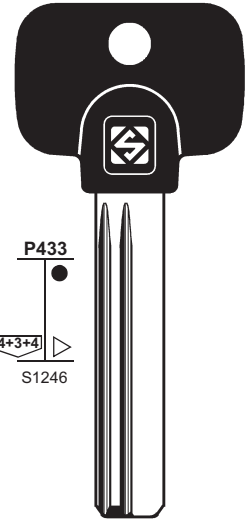

MGN1RP

PER:  
FOR:

## MASTER

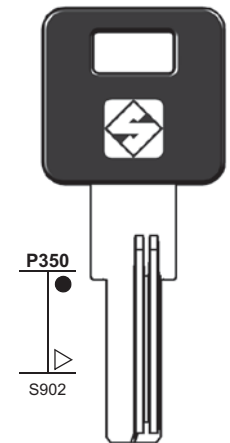

MS20P

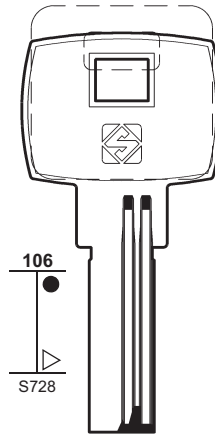

MS22

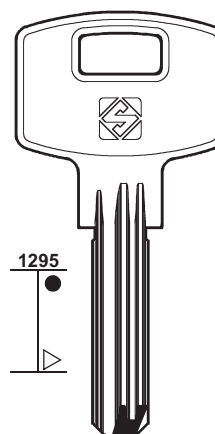

MS23

## MASTER LOCK

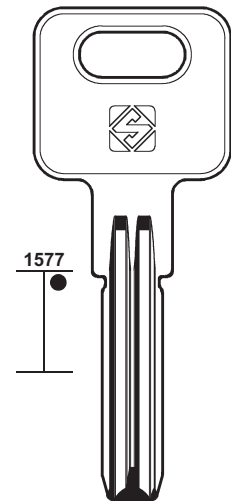

MSL1



PER:  
FOR:

### MCM

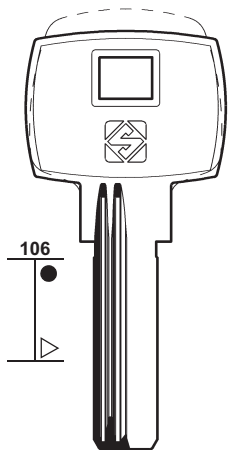

**MC14R**

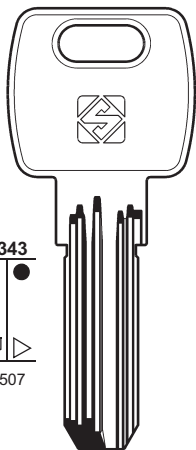

**MC15R**  
E8

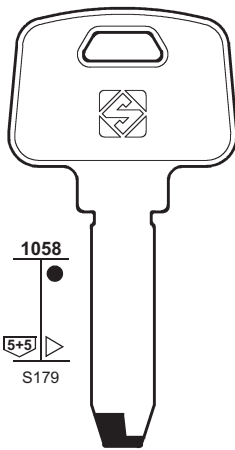

**MC9X**  
4SS

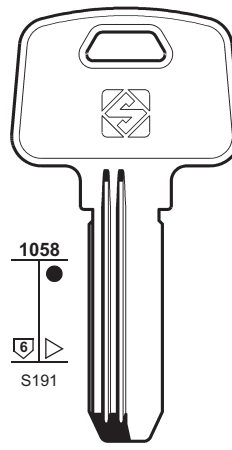

**MC10R**  
4SE

LOB - YETI

TROMER

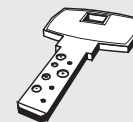

# 217

PER / FOR

**MCM** (E)  
LOB  
TROMER  
YETI

**MERONI** (I)

**MEGA** (RO)

**METAL** (BG)

**MG (MONTI)** (I)

**MLM** (F)

**MODA** (F)  
PICARDIE (219)

**MOREAUX** (F)  
DOM (210)

**MOTTURA** (I)  
GEVY (213)

**MULT-LEI** (GR)

PER:  
FOR:

### MERONI

### MEGA

### METAL

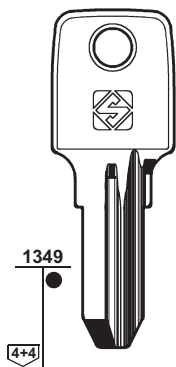

**MER38**

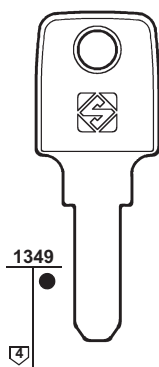

**MER39**

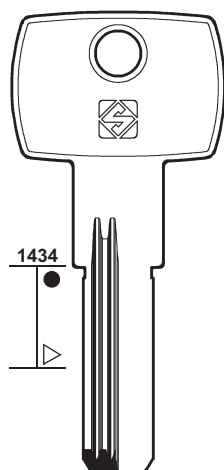

**MEG1R**

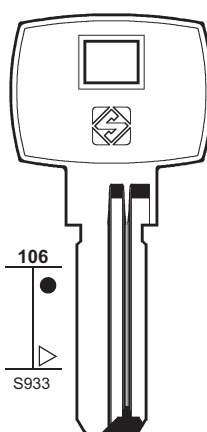

**MTA2**

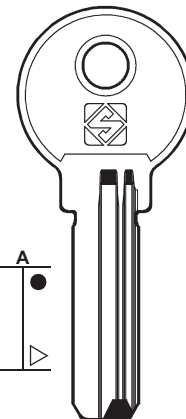

**MTA4**

PER:  
FOR:

### MG (MONTI)

### MLM

### MULT-LEI

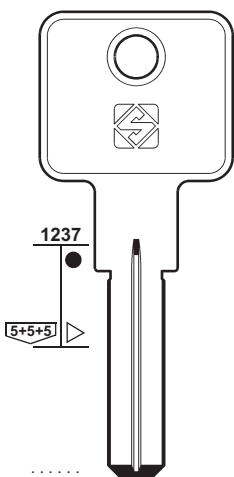

.....  
001001-163000

**MG8**  
PBA

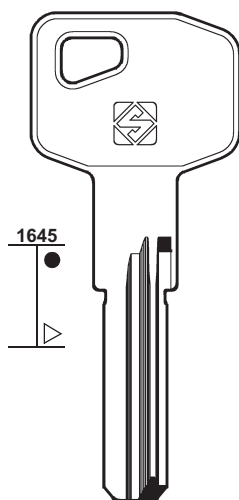

**MG9**

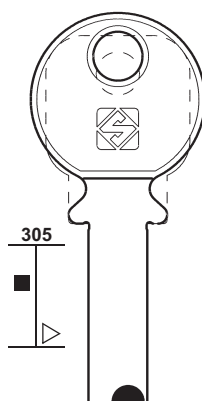

**MLM5**

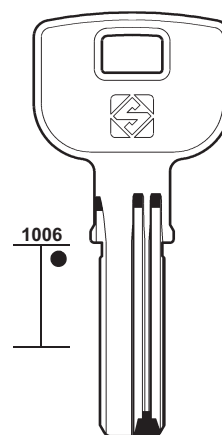

**MTL1**

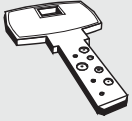

218

PER / FOR

MUL.T.LOCK (IL)  
GARRISON  
SP

OJMAR (E)

PER:  
FOR:

### MUL.T.LOCK

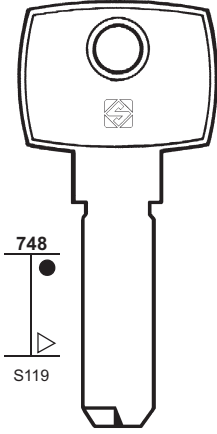

J...  
9001-9766

MTK1

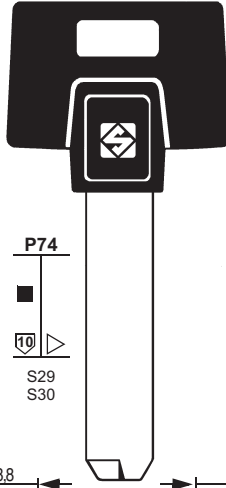

MTK2P  
(006)  
ABCD-12345

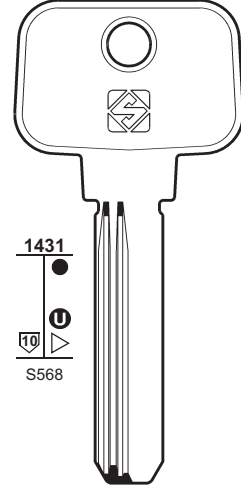

MTK3P  
(006)  
ABCD-12345-01

MTK16  
11

MTK15R  
66

MTK12R  
08  
(008)  
ABCD-12345

MTK13R  
77

MTK11R  
06

GARRISON

PER:  
FOR:

### MUL.T.LOCK

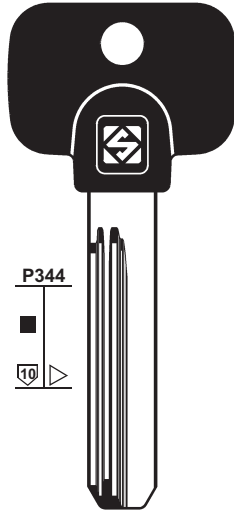

(006)  
ABCD-12345-01  
MTK10RP  
SP

MTK9RP

(006)  
MTK8RP  
64  
ABCD-12345-01

(006)  
MTK7RP  
50  
ABCD-12345-01

(006)  
MTK4P  
05  
ABCD-12345-01

(005)  
MTK4RP  
06  
ABCD-12345

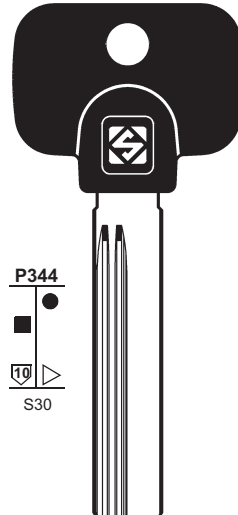

MTK4RPX  
06

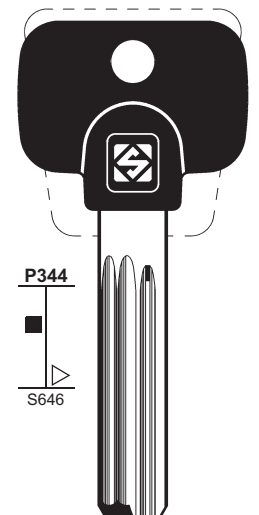

(008)  
ABCD-12345

MTK12RP  
08

PER:  
FOR:

### MUL.T.LOCK

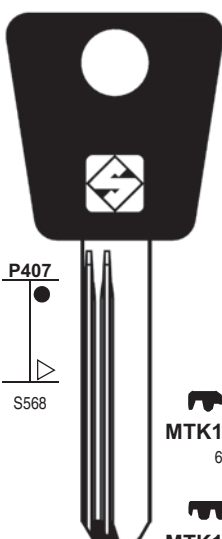

S568  
MTK15RAP  
66

MTK13RAP  
77

GARRISON

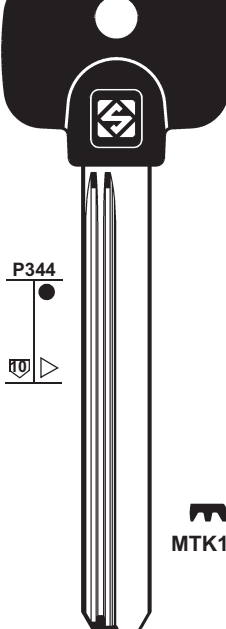

MTK14RP

### OJMAR

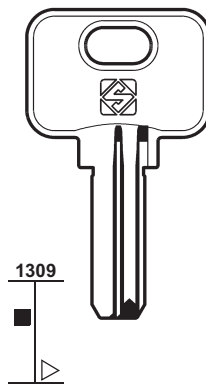

OJ14

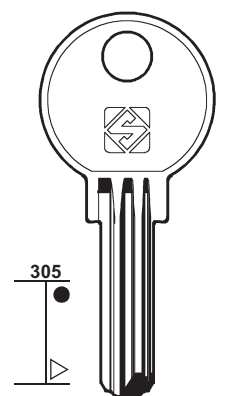

OJ18  
5-Q4

PER:  
FOR:

# OMECA

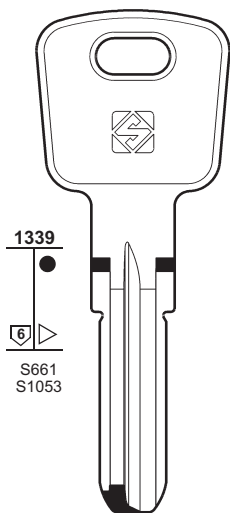

1339  
6  
S661  
S1053



OC3

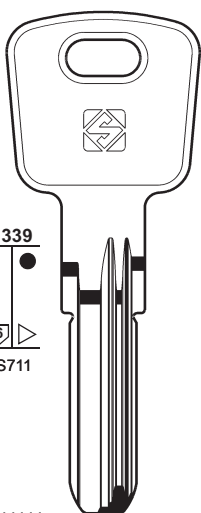

1339  
6  
S711

AB.....  
0000001-0046656



OC4

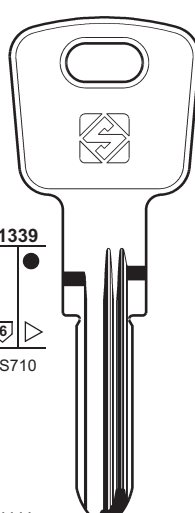

1339  
6  
S710

BA.....  
0000001-0046656



OC6

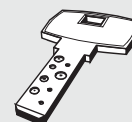

# 219

PER / FOR

OMECA (I)

PENZA (RUS)

PERINO PG (I)  
IMSI

PICARDIE (F)  
DECAYEUX  
MODA  
S & E  
STS

PICARD (F)  
KABA (214)

POTENT (I)

PREFER (I)

PER:  
FOR: PENZA

PERINO PG

PICARDIE

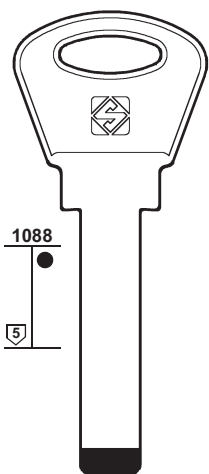

1088  
5



BZ3

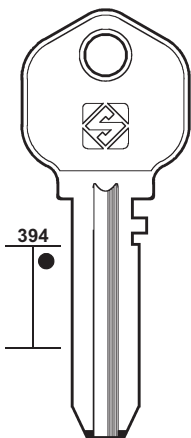

394



PN1

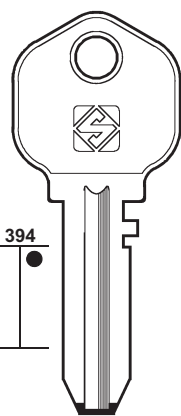

394



PN2

IMSI

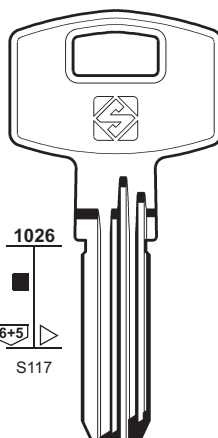

1026  
6+5  
S117



PIC1

DECAYEUX - MODA  
S & E - STS

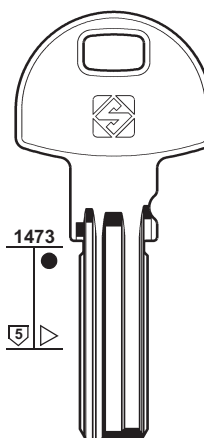

1473  
5



PIC2

PER:  
FOR: POTENT

PREFER

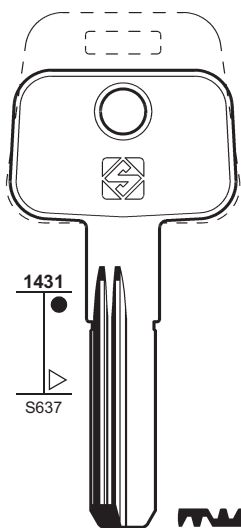

1431  
6  
S637



PT4R

..... 1-2-3-4-5

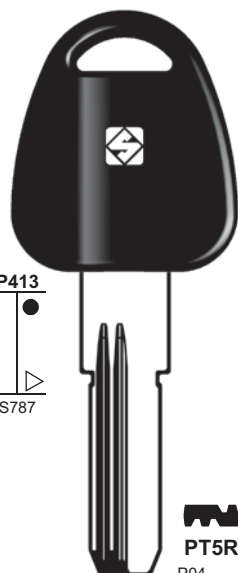

P413  
S787



PT5RP

P04.....  
1-2-3-4-5-6

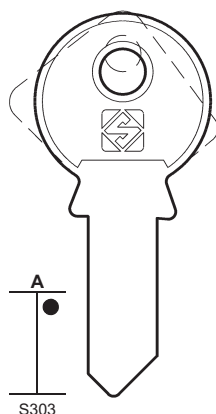

A  
S303



PF18

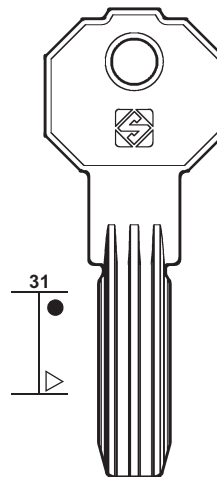

31



PF20

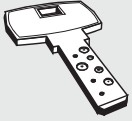

# 220

PER / FOR

**ROSSETTI** (R)

**S-TECH** (GB)

**S & E** (F)  
PICARDIE (219)

**SARGENT** (USA)  
KESO (215)

**SATURN** (SLO)  
BASI

**SEA** (CH)  
EZCURRA  
HASLER  
VIDMAR

**SECUREMME** (I)

**SERRALLER** (E)  
AGA (205)

**SP** (F)  
FTH (212)  
MUL.T.LOCK (218)

**SPIDER** (IL)  
CAVERS  
CODKEY

PER: **ROSSETTI**

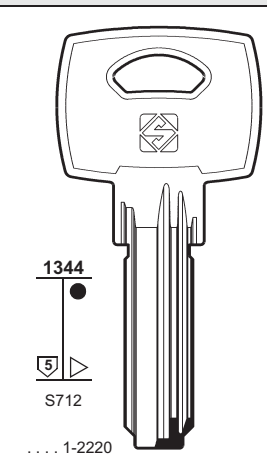

**RSS3**

PER: **S-TECH**

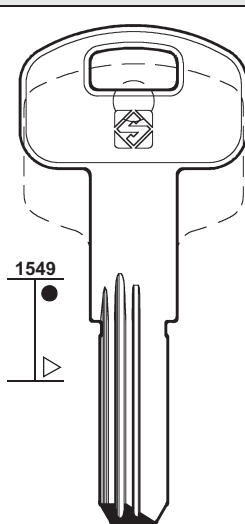

**SCH1R**

PER: **SATURN**

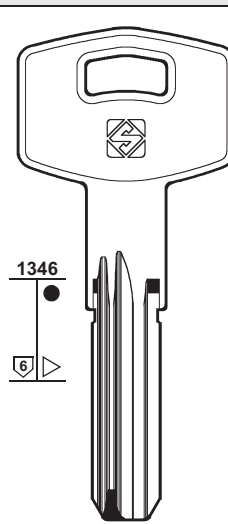

**STU6R**

BASI

PER: **SEA**

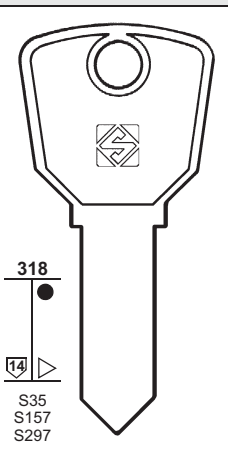

**SEB1**  
20-23

EZCURRA - HASLER

PER: **SEA**

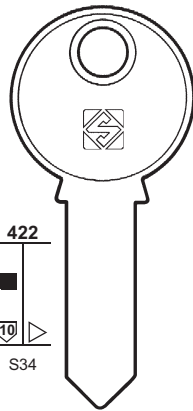

**SEB2**

EZCURRA - HASLER  
VIDMAR

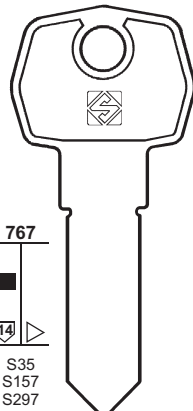

**SEB3**

20-23

PER: **SECUREMME**

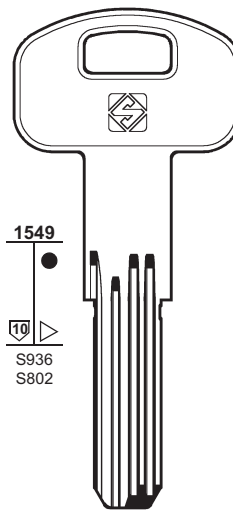

**SCM1R**

K2

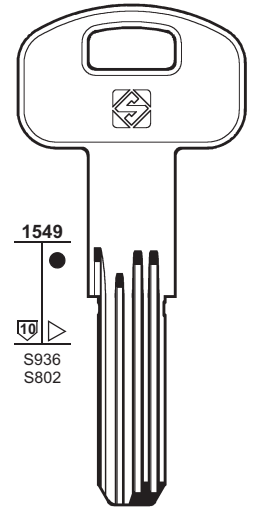

**SCM2**

K1

PER: **SECUREMME**

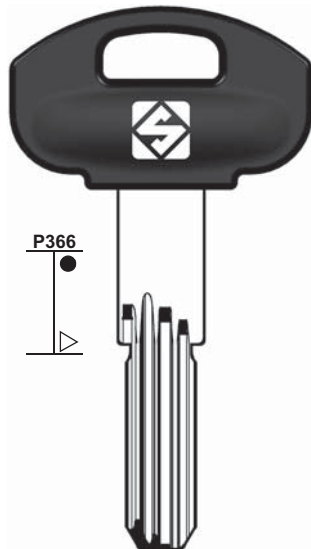

**SCM3RP**

PER: **SPIDER**

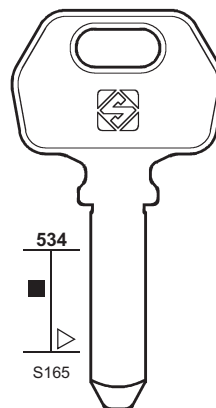





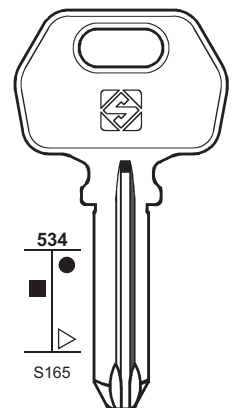

**SPR1**

CODKEY

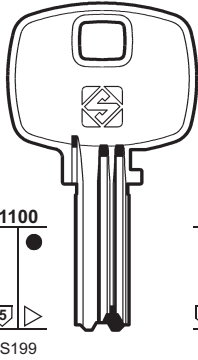
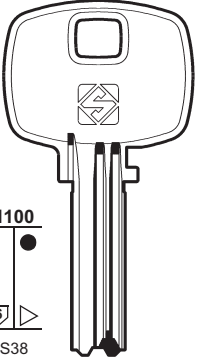
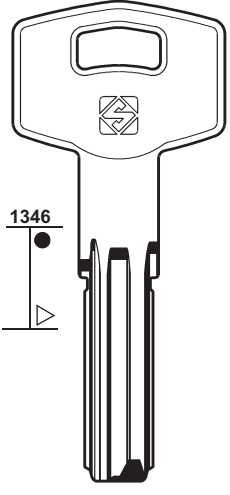
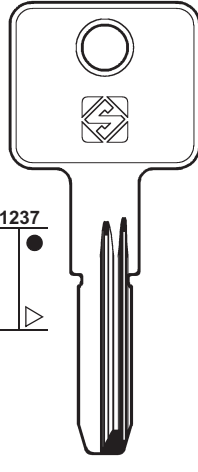
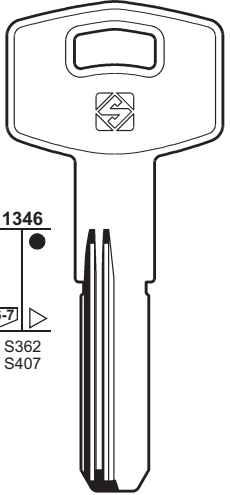
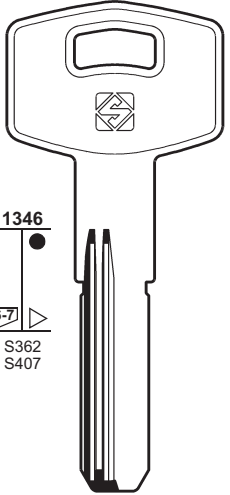

**SPR2**





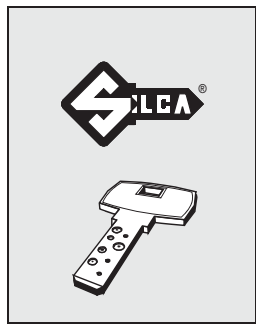

CAVERS



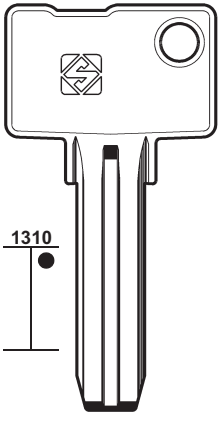
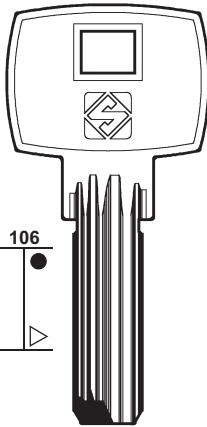
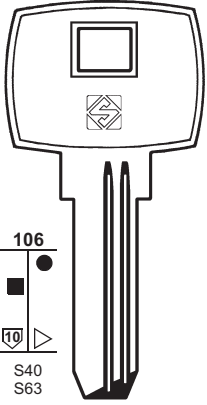
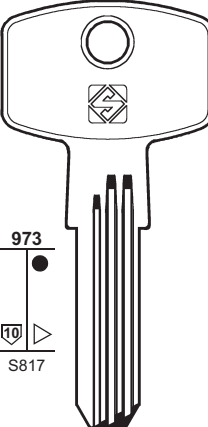
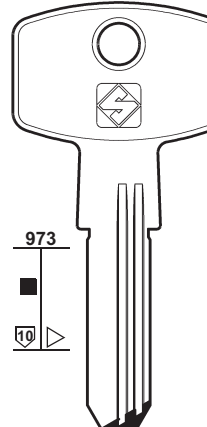
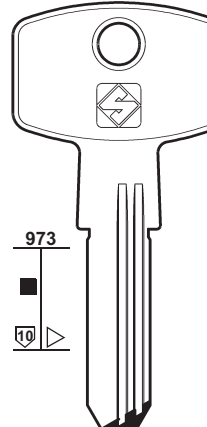

STS			TARONI		
					
1100 5 S199	1100 6 S38 S62 S199 S436 P... 5001-8030	1346 S407	1237	1346 5-6-7 S362 S407	
 STS5	 STS6 J K	 STS9	 TAR21	 TAR16	 TAR16R

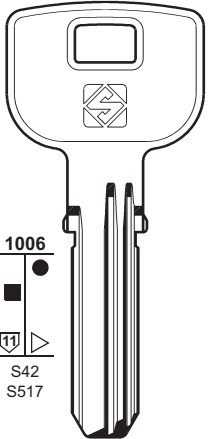
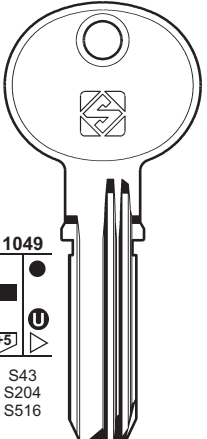
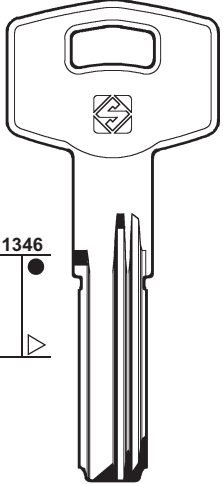
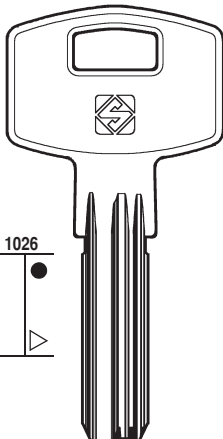

# 221

- PER / FOR**
- STS (E)**
    - + DOM (210)
    - + ELCA (210)
    - + PICARDIE (219)
    - + TESA (221)
  - TARONI (I)**
  - TECSESA (E)**
  - TEGASI (GR)**
  - TERCA (E)**
    - + AGA (205)
  - TESA (E)**
    - KALE
    - STS
    - VIRO
    - + ELCA (210)
  - THIRARD (F)**

PER: FOR: <b>TECSESA</b>	<b>TEGASI</b>	<b>TESA</b>			
					
1310	106	106 S40 S63	973 S817	973	
 TEC1	 TGS1R	 TE4 T-10	 TE4R	 TE16 T-10P	 EC5
		STS		KALE - STS - VIRO	

TESA			<b>THIRARD</b>
			
1006 S42 S517	1049 S43 S204 S516	1346	1026
 TE5 T-80	 TE7 T-60	 TE19	 THR1
STS		STS	

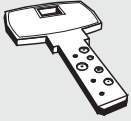

# 222

**PER / FOR**

**TITAN** (SLO)

**TOVER** (E)  
MASTER  
TROMER

+ FTH (212)

**TROMER** (E)

MCM (217)  
 TOVER (222)

**UCEM** (E)

ESAFE  
ISEO  
YEMAR

**URBIS** (R)

BSS  
YALE

**VACHETTE** (F)

+ ISEO (213)

**PER: TITAN**

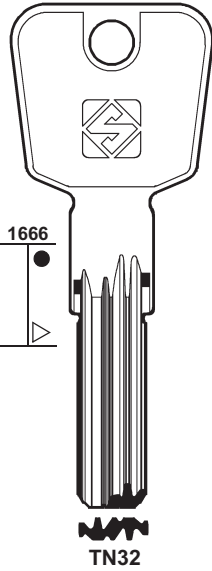

**FOR: TOVER**

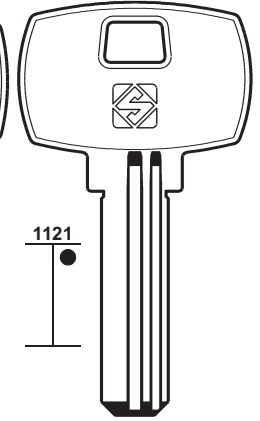
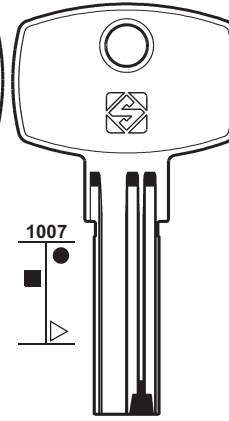
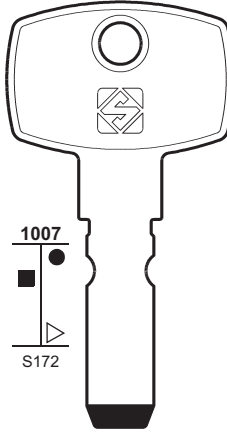
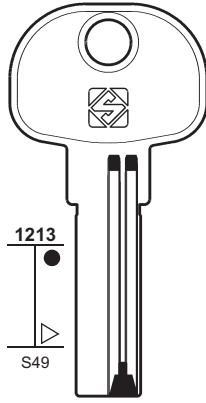

MASTER

TROMER

**PER: UCEM**

**FOR:**

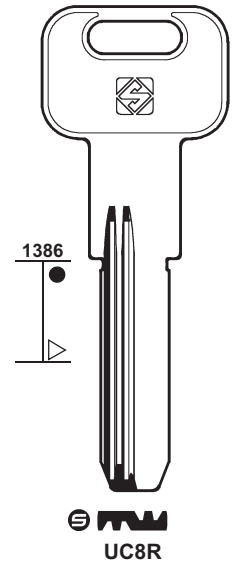
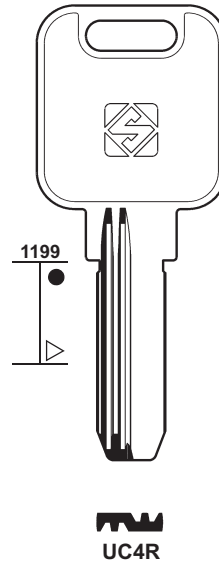
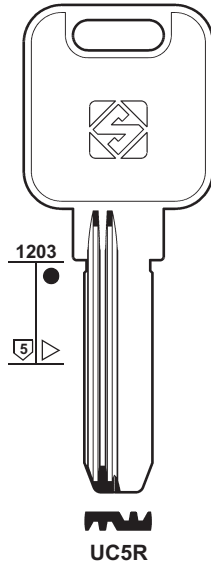
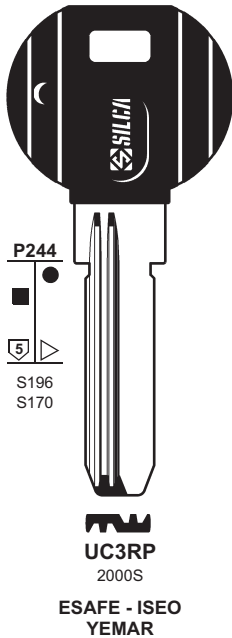

**PER: URBIS**

**FOR:**

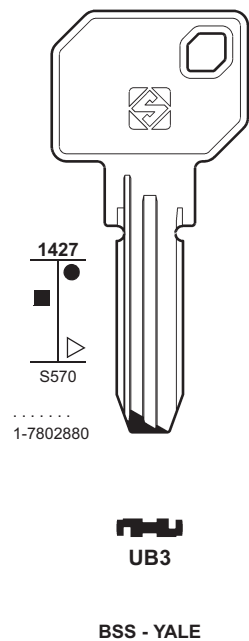



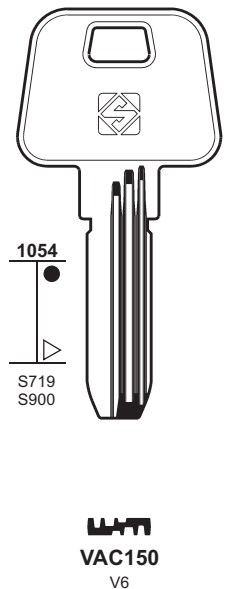
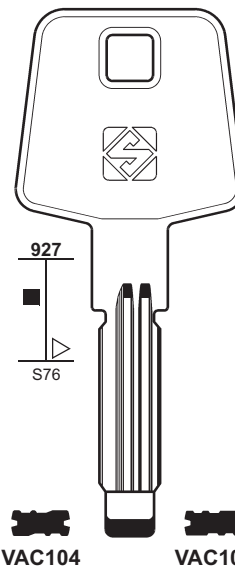
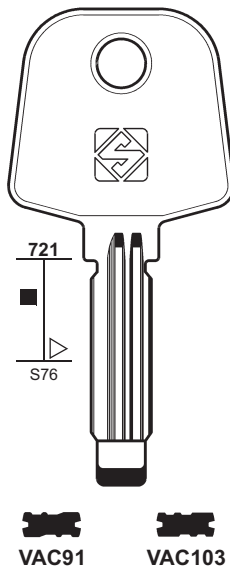

**FOR: VACHETTE**

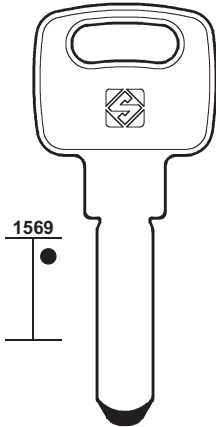
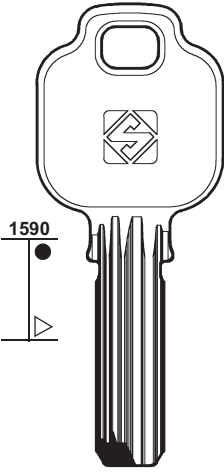
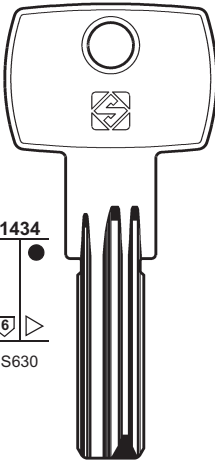
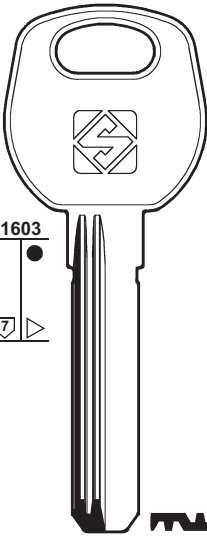

RADIAL

RADIAL





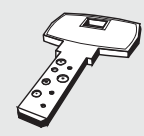

PER: FOR:	<b>VANGUARD</b>	<b>VBH</b>	<b>VIRO</b>	<b>WANJIN</b>
				
	1569	1590	1434	1603
			6 S630	7
				
	<b>VGD1</b>	<b>VBH1R</b>	<b>VI19</b> EURO-PRO	<b>WJ1R</b>
			<b>FEB</b>	<b>HOOPLY</b>



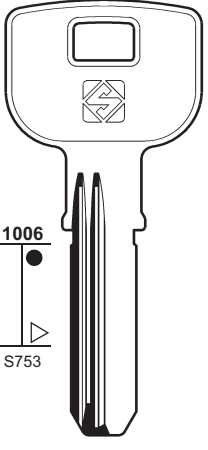
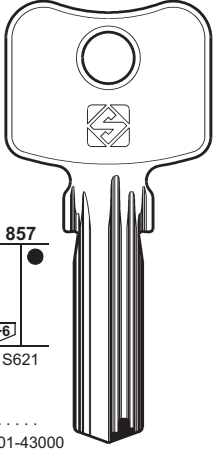
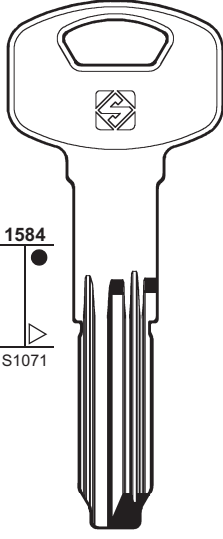
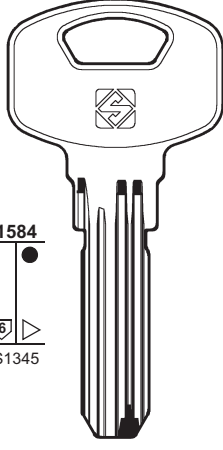



# 223

PER / FOR	<b>VANGUARD (RA)</b>
<b>VBH (D)</b>	+  FCV (212)
<b>VIDMAR (CH)</b>	SEA (220)
<b>VIRO (I)</b>	FEB +  ELCA (210) +  TESA (221)
<b>WANJIN (PRC)</b>	HOOPLY
<b>WAUS (P)</b>	
<b>WILKA (D)</b>	
<b>YALE (GB)</b>	+  URBIS (222)
<b>YALE (I)</b>	
<b>YALTRES (RA)</b>	FTH (212)
<b>YARDENI (IL)</b>	
<b>YEMAR (E)</b>	UCEM (222)
<b>YETI (PL)</b>	MCM (217)

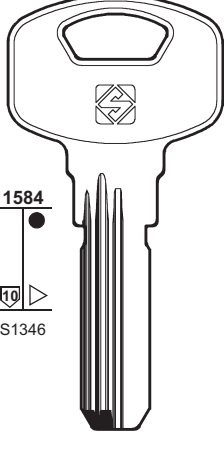
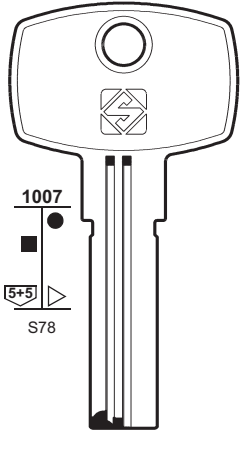
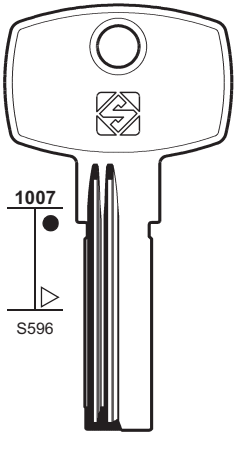
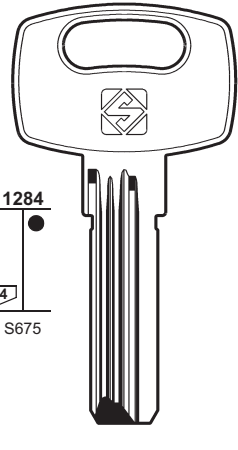
PER: FOR:	<b>WAUS</b>	<b>WILKA</b>	<b>YALE (I)</b>	<b>YALE (GB)</b>
				
	1006	857	1584	1584
	S753	6+6 S621	S1071	6 S1345
				
	<b>WU1R</b>	<b>WK70</b>	<b>YA90</b>	<b>YA94</b> "1000 Series"

.....  
10001-43000

PER: FOR:	<b>YALE (GB)</b>	<b>YARDENI</b>		
				
	1584	1007	1007	1284
	10 S1346	5+5 S78	S596	4+4 S675
				
	<b>YA95R</b> "2000 Series"	<b>YD6R</b>	<b>YD7R</b>	<b>YD13R</b> XL <b>YD14R</b> 6

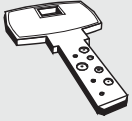

**224**

PER / FOR

ZADI (I)  
BULLOCK

ZHONGHENG (PRC)

PER:  
FOR:

**ZADI**

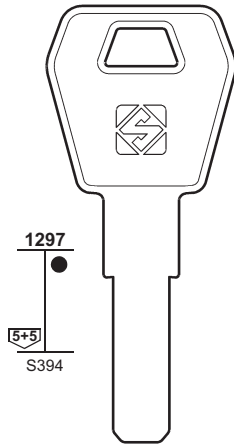

**ZD25**  
BULLOCK

**ZHONGHENG**

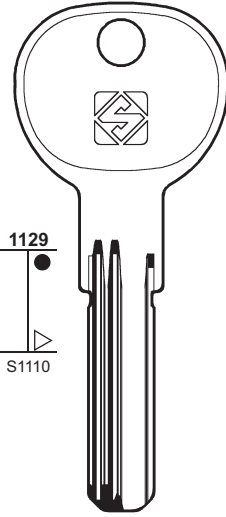

**ZH1R**

PER:  
FOR:

PER:  
FOR: