

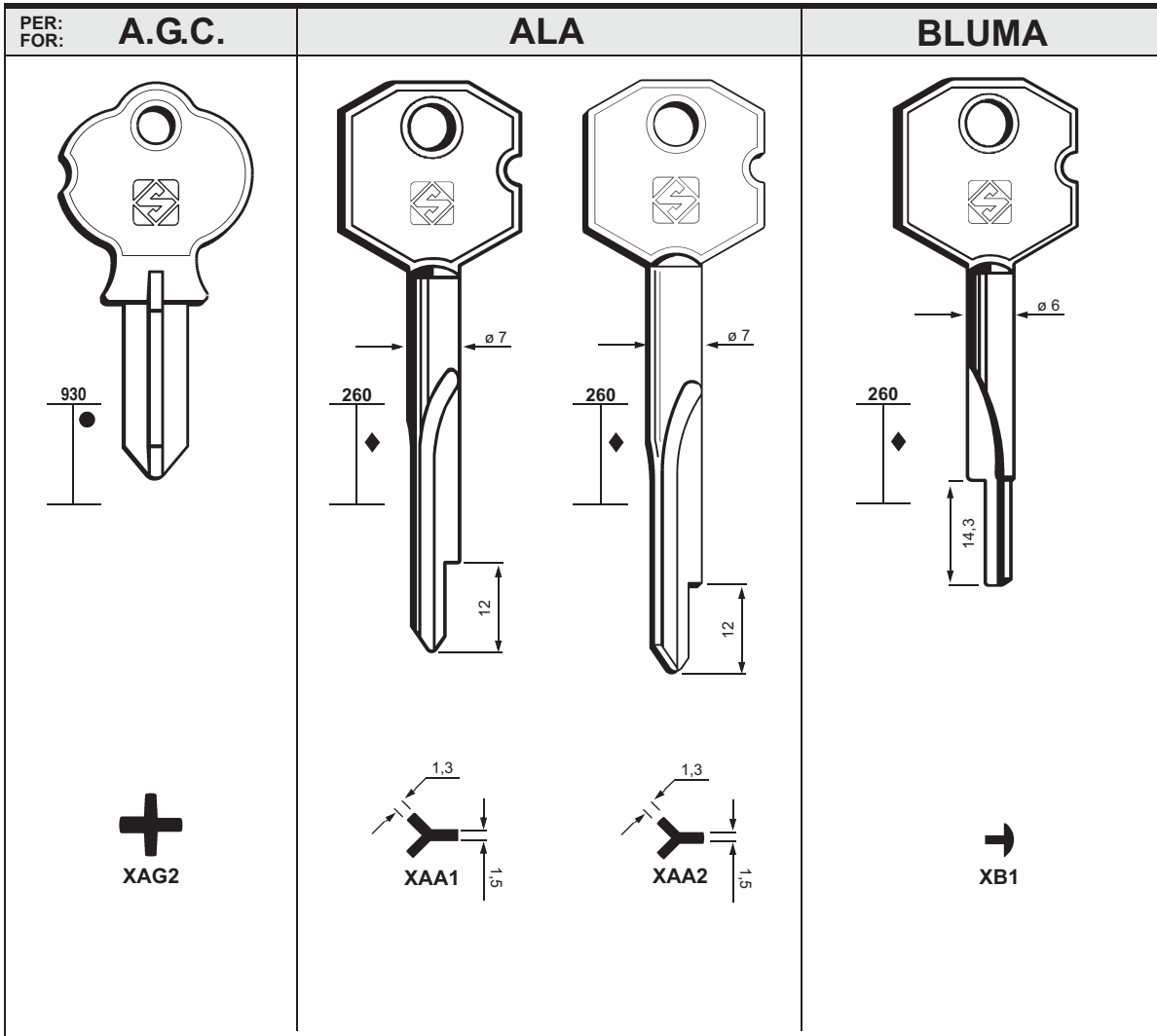

Cruciform Keys  
Chiavi a croce  
Kreuzschlüssel  
Clés cruciformes  
Llaves en cruz  
Chaves tetra





**227**

PER / FOR
A.G.C. (P)
ALA (I)
BKS (D)
YALE (237)
BLUMA (D)
BRASIL (BR)
BRYANSK (RUS)

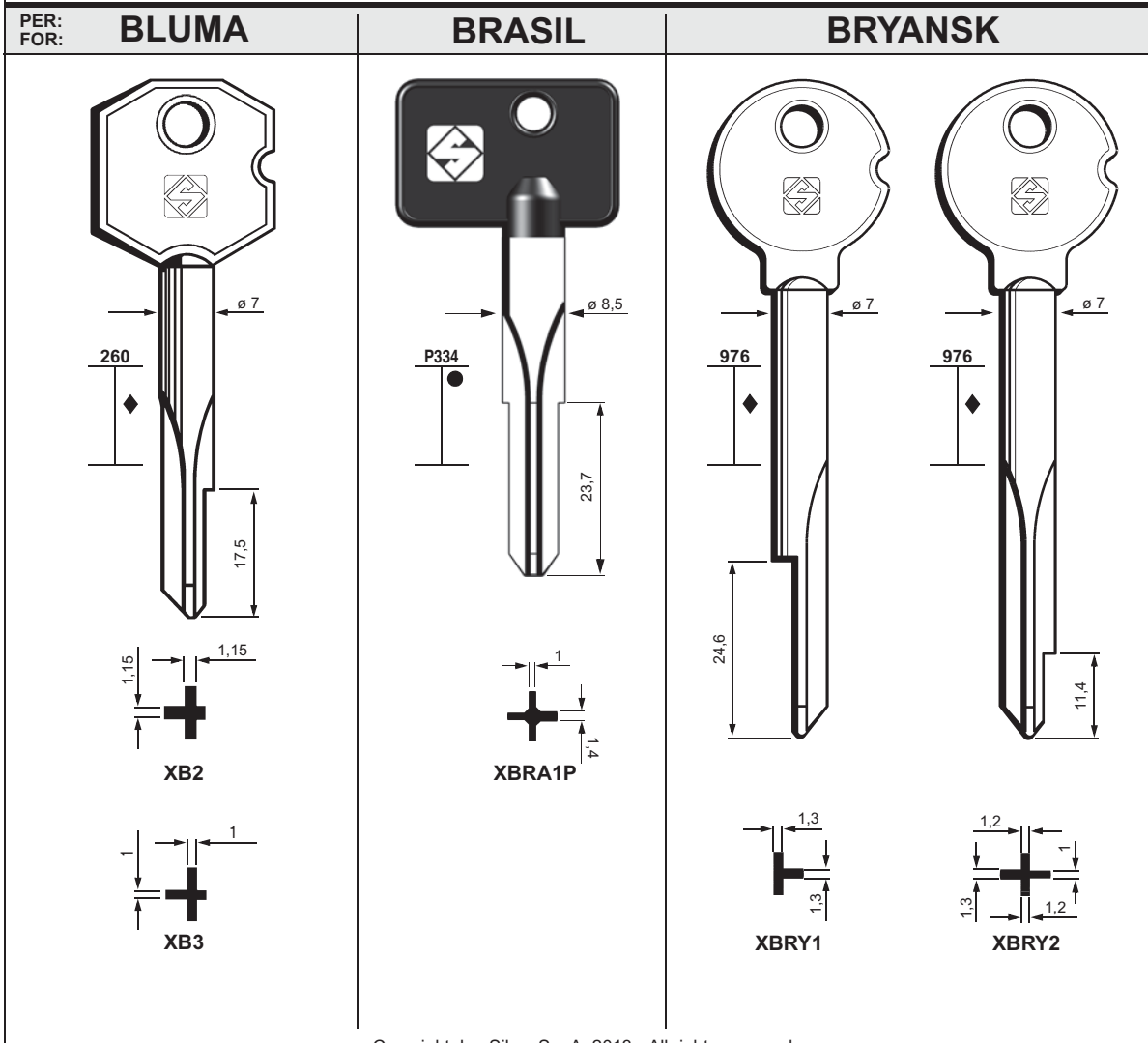

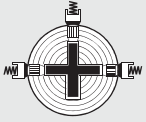

228

PER / FOR

BURG WÄCHTER (D)  
FIAM PRÄZIS  
TRIOVING

PER:  
FOR:

### BURG WÄCHTER - Fiam Präzis

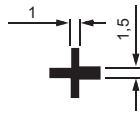
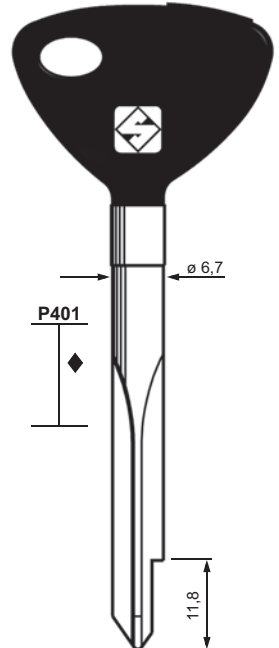
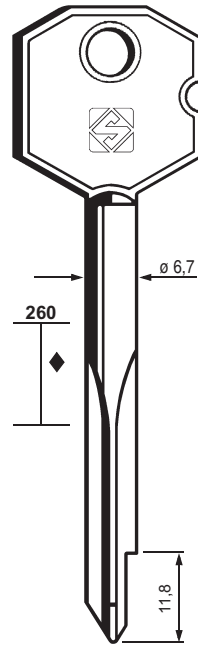
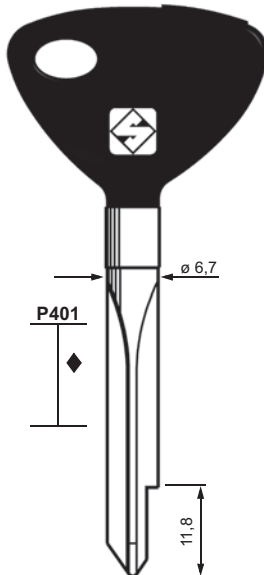
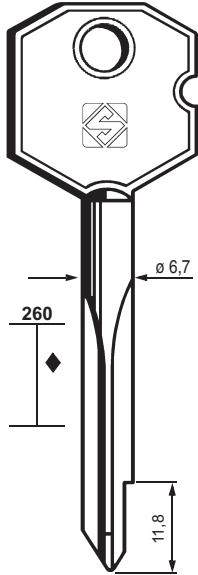

**XBW1**  
mm 75

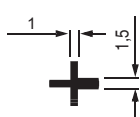

**XBW1P**  
mm 75

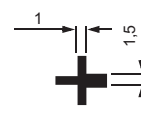

**XBW2**  
mm 85

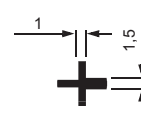

**XBW2P**  
mm 85

TRIOVING

PER:  
FOR:

### BURG WÄCHTER - Fiam Präzis

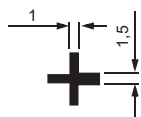
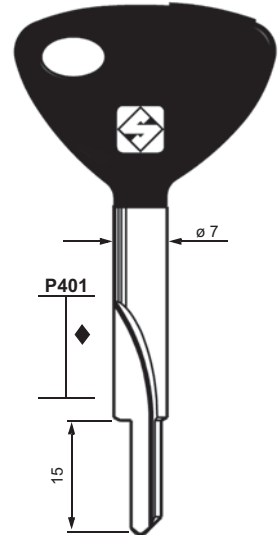
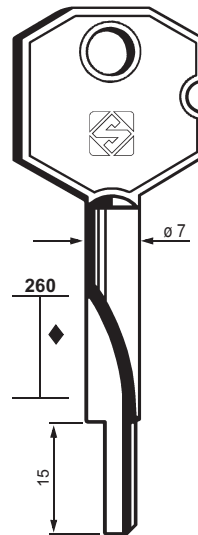
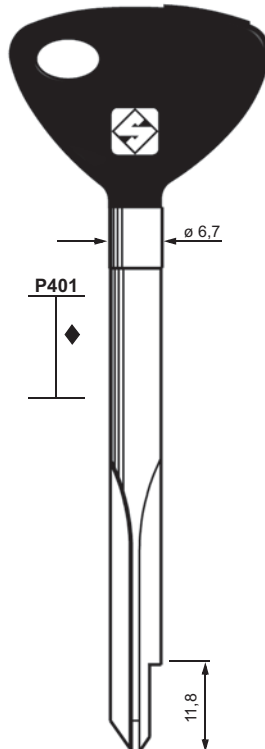
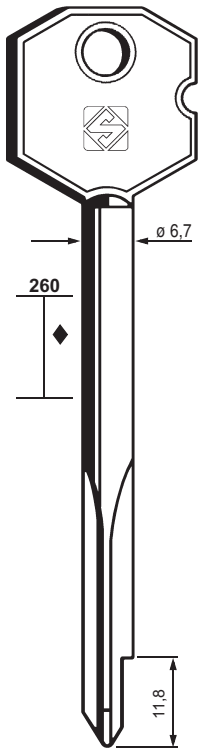

**XBW3**  
mm 100

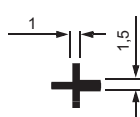

**XBW3P**  
mm 100

**XBW4**

**XBW4P**

PER:  
FOR:

# BURG WÄCHTER - Fiam Präzis



# 229

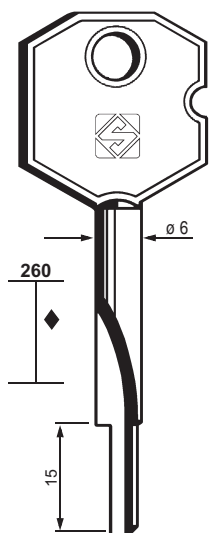

➔  
**XBW5**

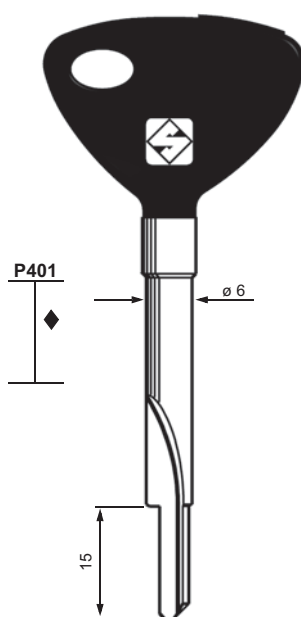

➔  
**XBW5P**

PER / FOR

**BURG WÄCHTER** (D)  
FIAM PRÄZIS

**BRICARD** (F)

**C.R.** (I)  
YALE (237)

**CCF** (P)

PER:  
FOR:

## BRICARD

## CCF

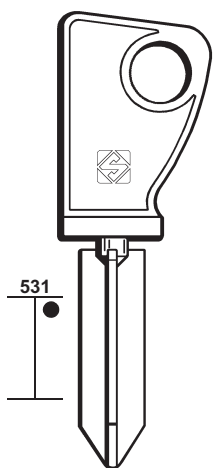

531

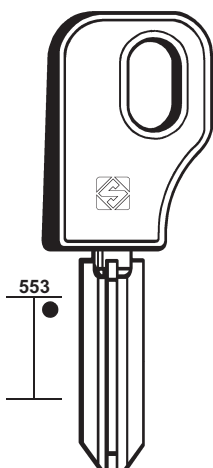

553

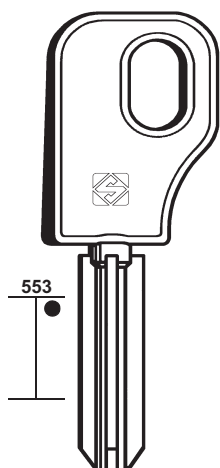

553

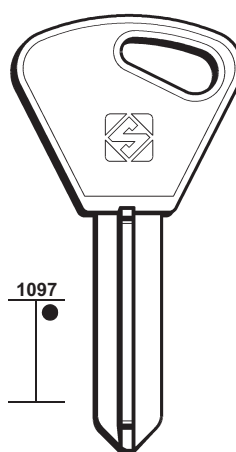

1097

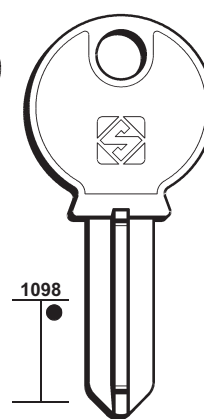

1098



**XBD2**



**XBD3**



**XBD4**



**XBD5**



**XBD6**



**XBD1**



**XBD7**



**XCCF2**  
CCF5



**XCCF3**  
CCF4

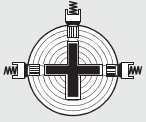

**230**

PER / FOR

CCF (P)

CRC - CAMBOA (P)

FAB (CZ)

PER:  
FOR:

**CCF**

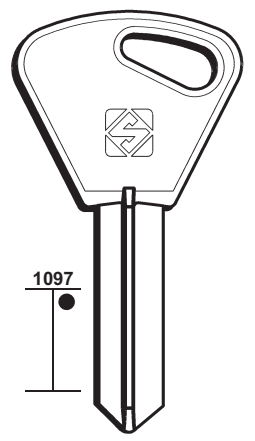
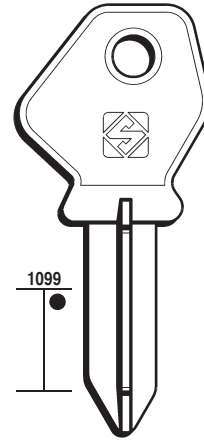
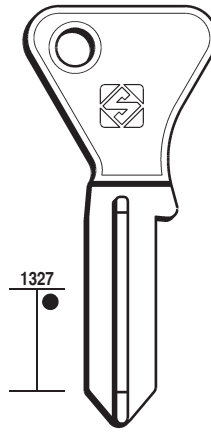
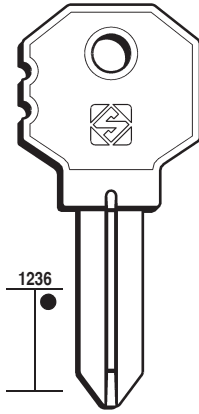
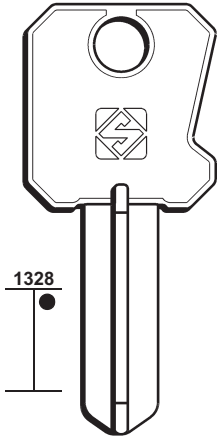

**XCCF6**  
CCF6



**XCCF7**  
CCF7



**XCCF8**  
CCF8



**XCCF9**  
CCF9



**XCCF10**  
CCF10

PER:  
FOR:

**CRC-CAMBOA**

**FAB**

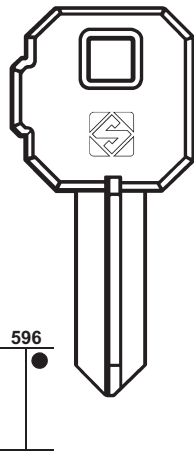

**XC1**

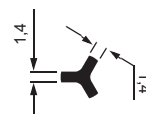
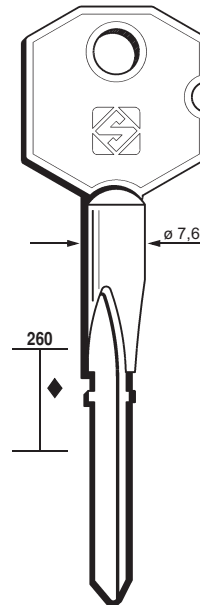

**XFB1**

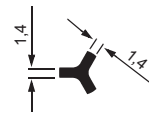
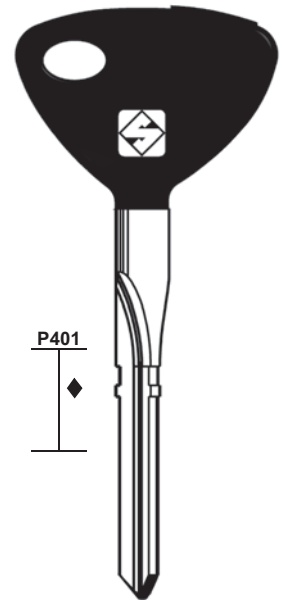

**XFB1P**

PER:  
FOR:

### FIAM

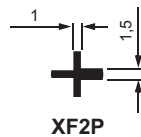
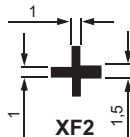
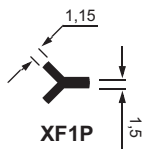
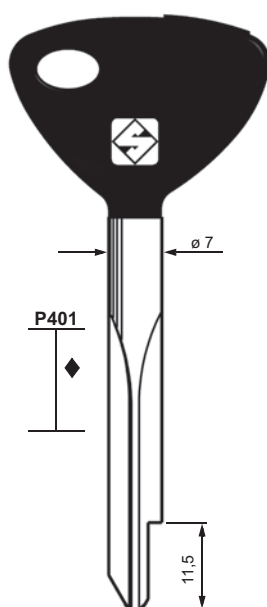
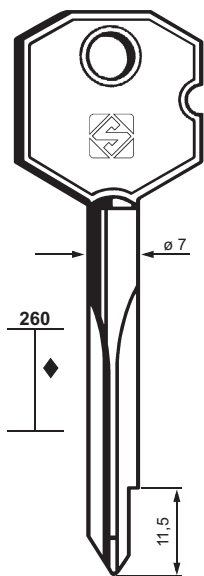
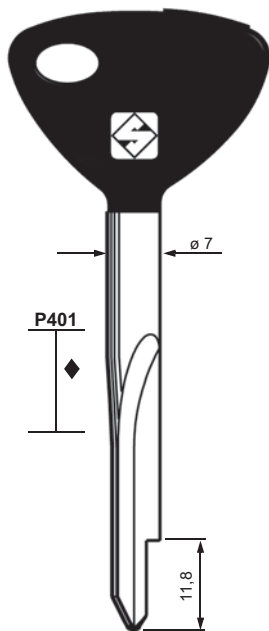

KALE

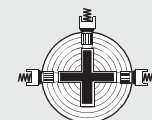

# 231

PER / FOR

**FIAM (I)**

KALE

+ YALE (237)

**FIAM PRÄZIS (I)**

+ BURGWÄCHTER

(228-229)

+ YALE (237)

**FRIPA (D)**

**GERA (D)**

**G.R. (F)**

(GUERVILLE RIQUIER)

PER:  
FOR:

### FRIPA

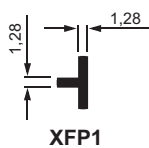
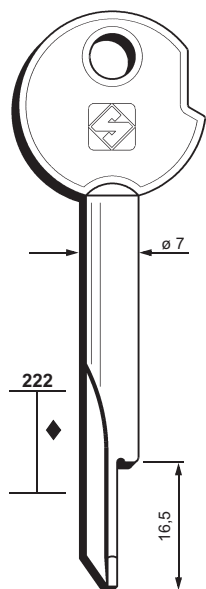

### G.R.

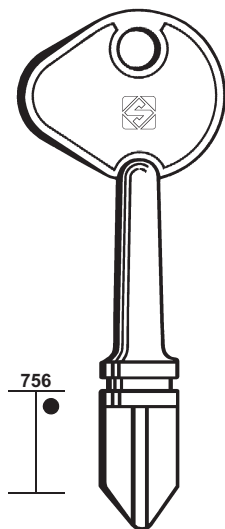

GUERVILLE-RIQUIER

### GERA

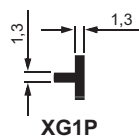
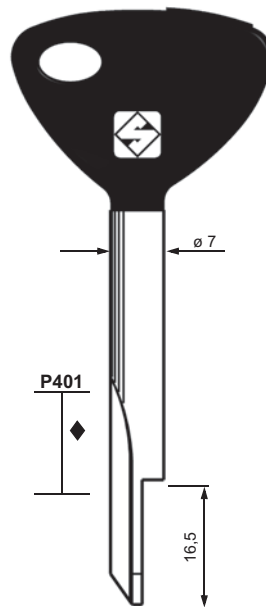

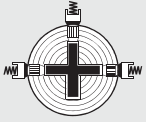

**232**

PER / FOR

HELCO - KFV (D)

ISEO (I)

KALE (TR)

FIAM (231)

PER:  
FOR:

**HELCO - KFV**

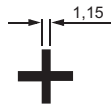
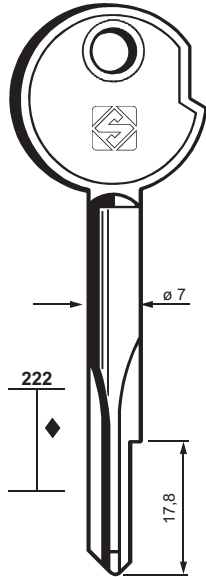

**XH1**  
mm 75

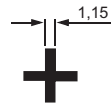
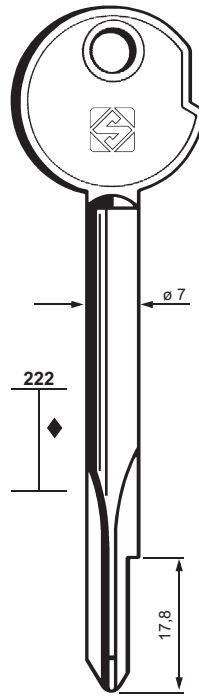

**XH2**  
mm 85

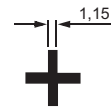
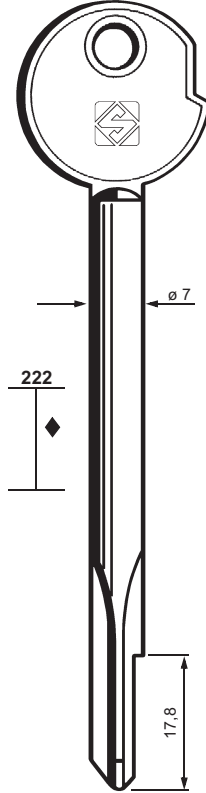

**XH3**  
mm 100

PER:  
FOR:

**ISEO**

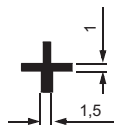
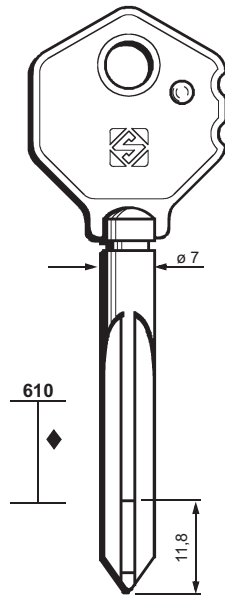

**XIE3**

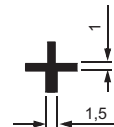
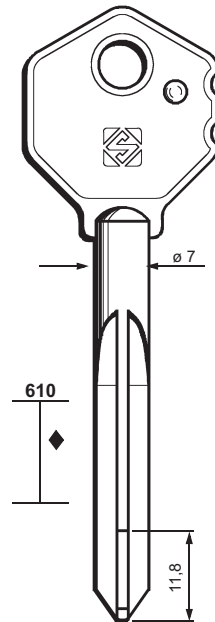

**XIE4**



PER:  
FOR:

# KIROV

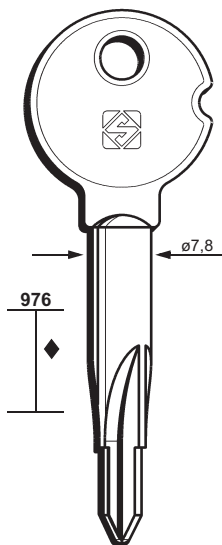

XKV11

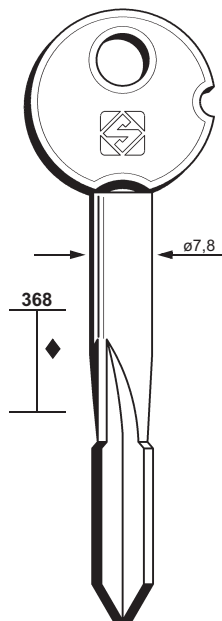

XKV6

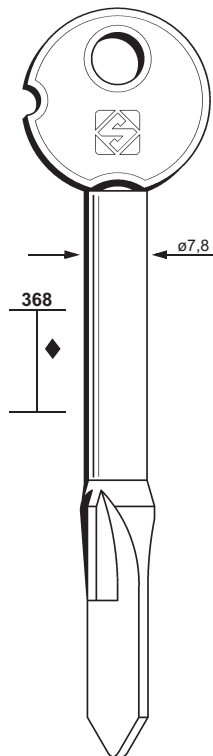

XKV8

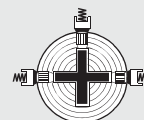
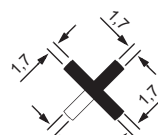
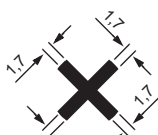
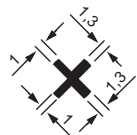

# 233

PER / FOR

KIROV (RUS)

LIPS (NL)

ZEISS - IKON (240)

PER:  
FOR:

# KIROV

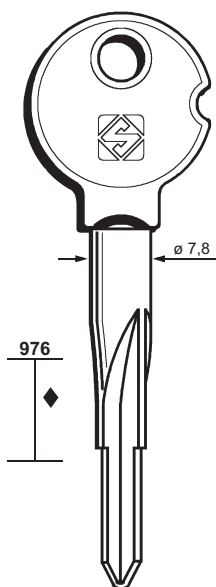

XKV2

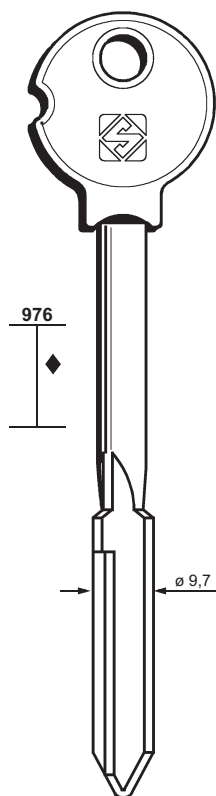

XKV7

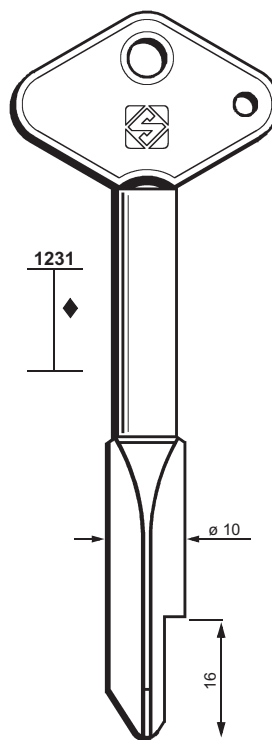

XKV10

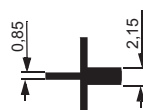
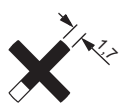
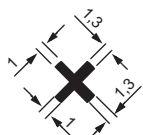

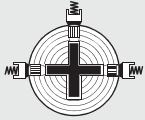

# 234

PER / FOR

MAFOR (F)  
RONIS  
SOS

MOBELLA (S)

MOREAUX (F)

NABOB (IL)

PER:  
FOR:

## MAFOR

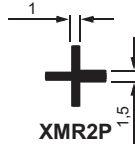
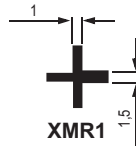
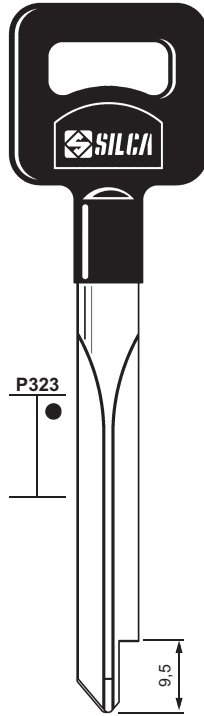
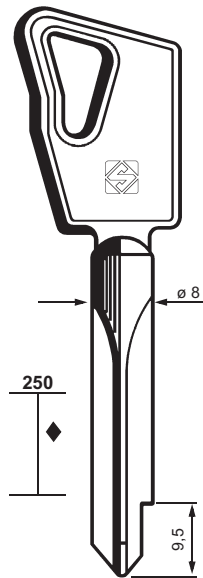

RONIS - SOS

## MOBELLA

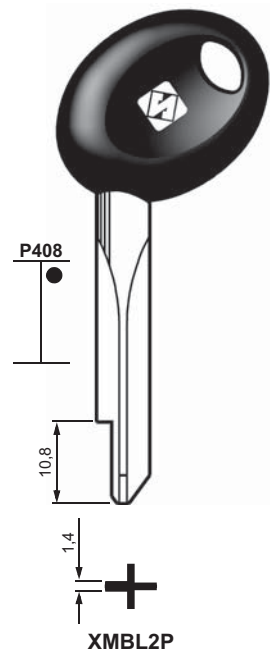

PER:  
FOR:

## MOREAUX

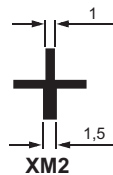
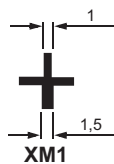
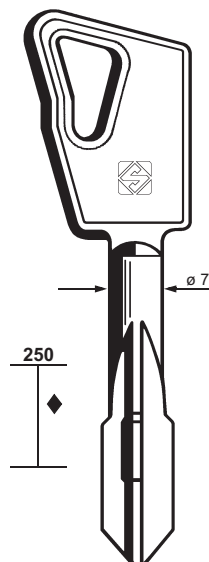
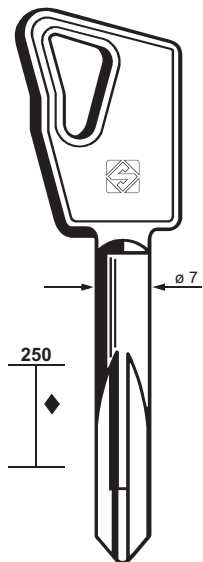

## NABOB

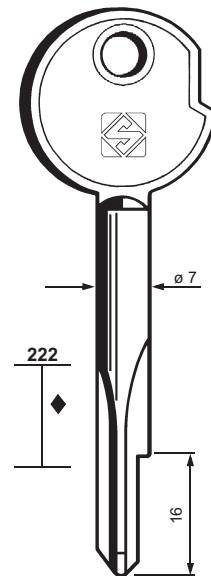

PER:  
FOR:

### NEMEF

### OMEC

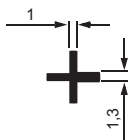
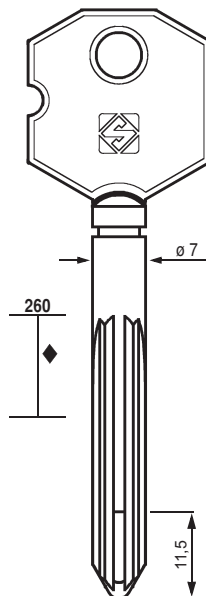
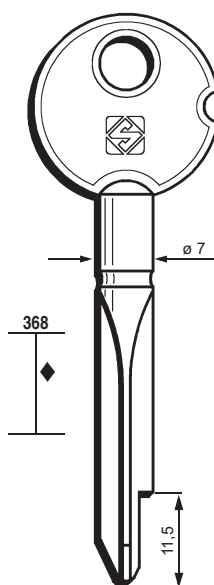
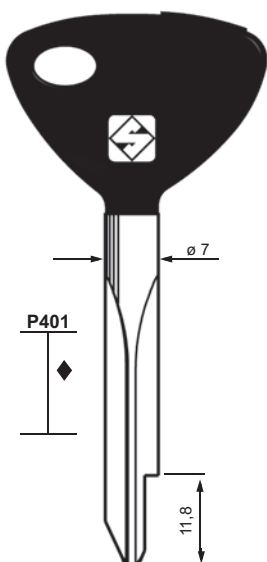
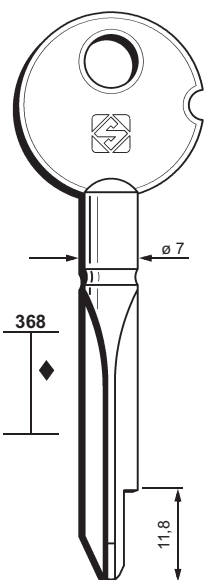

XPDO1P

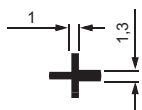

XPZ1

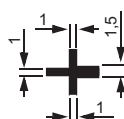

XPZ1P



XPZ2P

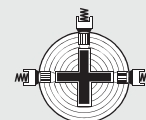

# 235

PER / FOR

NEMEF (NL)

OMEC (I)

PADO (BR)

PAPAIZ (BR)

PER:  
FOR:

### PADO

### PAPAIZ

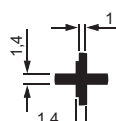
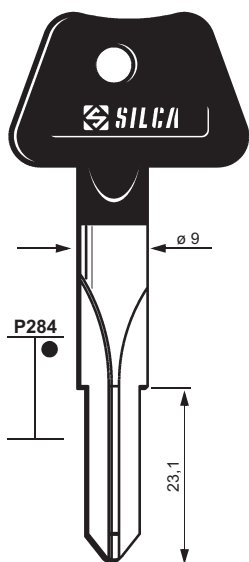

XPDO1P

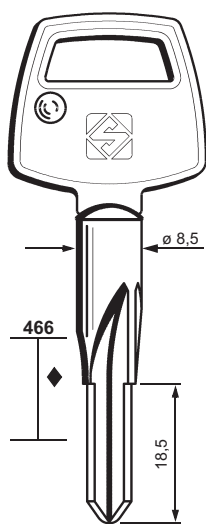

XPZ1

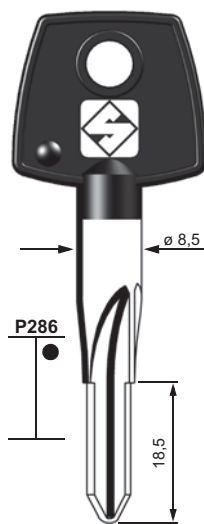

XPZ1P

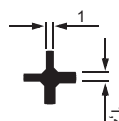
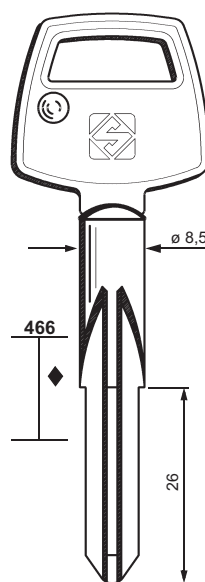

XPZ2

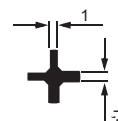
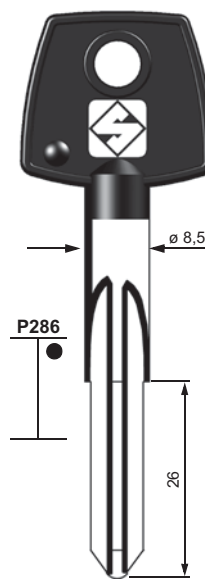

XPZ2P

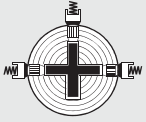

# 236

PER / FOR

**PUNKT** (D)

**RONIS** (F)

MAFOR (234)

**SELMACH** (RUS)

**STAM** (BR)

**SOS** (F)

MAFOR (234)

**TRIOVING** (S)

BURG WÄCHTER (228)

**TUFF** (HK)

## PER: FOR: PUNKT

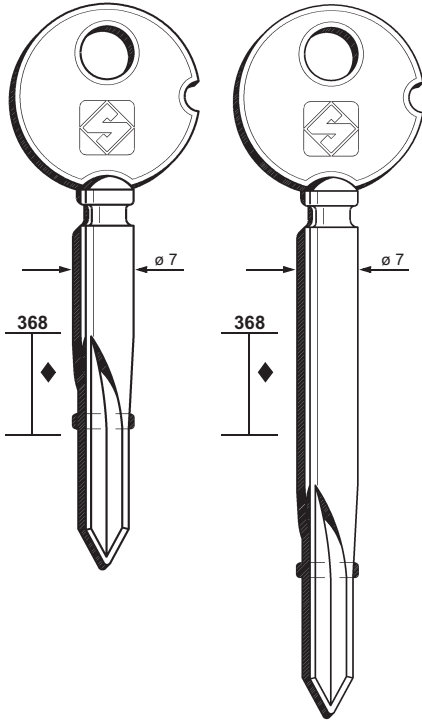

XPK1



XPK2

## PER: FOR: SELMACH

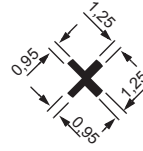
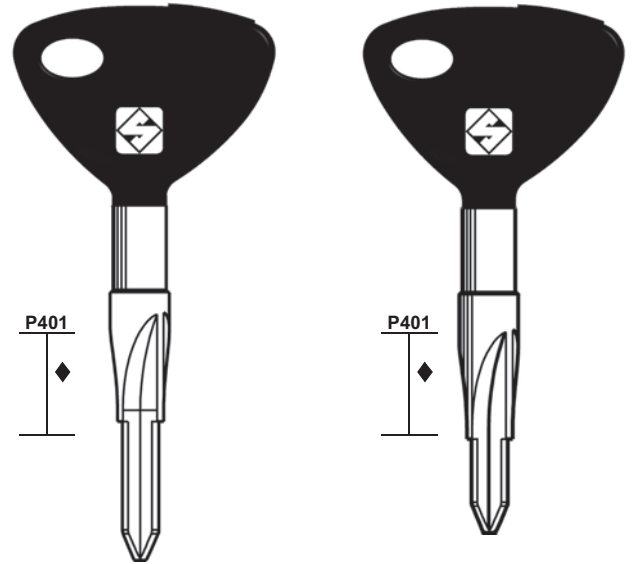

XSLH1P

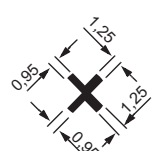

XSLH2P

## PER: FOR: STAM

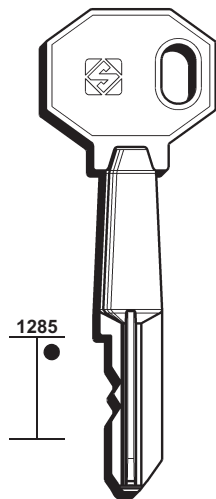

XSAM3

## PER: FOR: TUFF

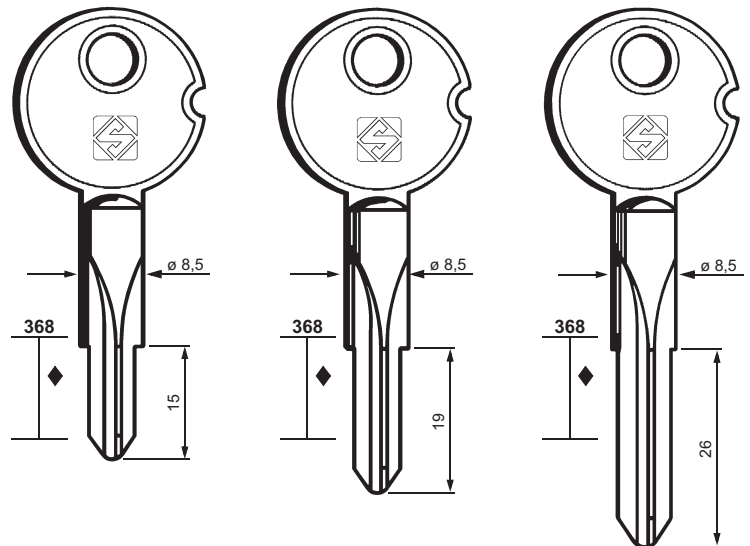

XTF1



XTF2

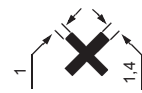

XTF3

PER:  
FOR:

# YALE - BKS



# 237

PER / FOR

**YALE (D)**  
BKS

**YALE (I)**  
C.R.  
FIAM PRÄZIS

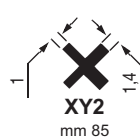
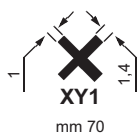
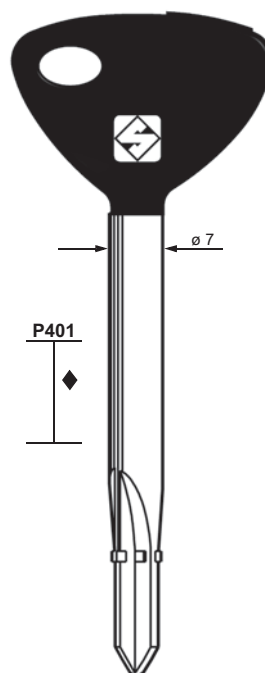
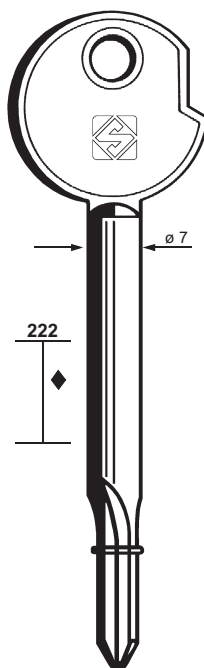
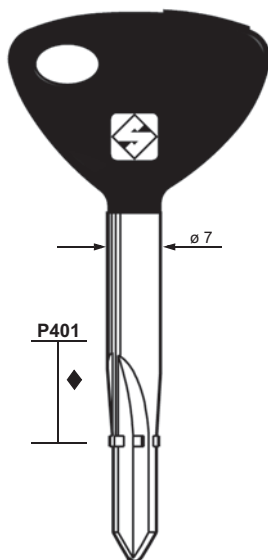
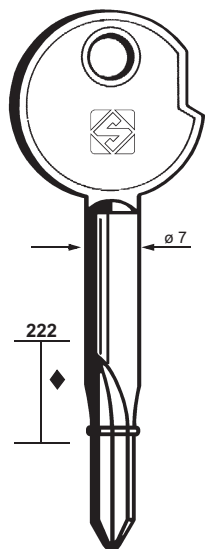

BKS

BKS

PER: **YALE - BKS**

YALE (I)

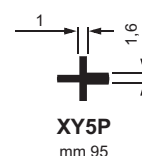
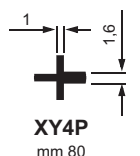
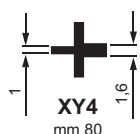
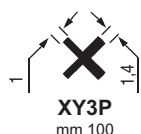
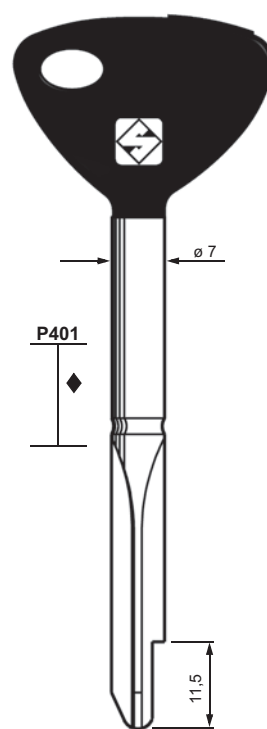
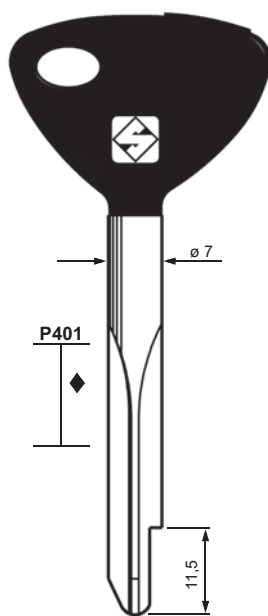
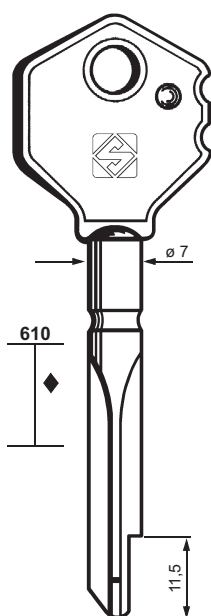
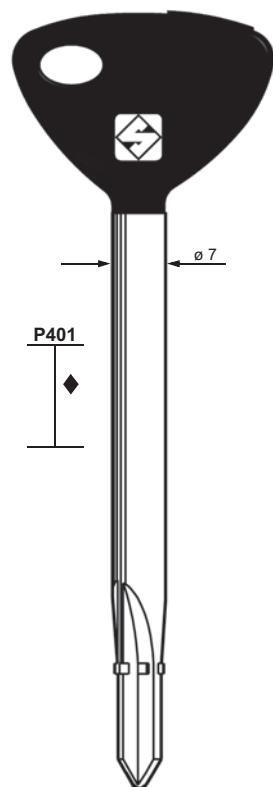

C.R. - FIAM PRÄZIS

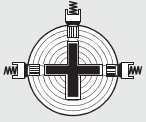

238

PER / FOR

YALE (I)

YALTRES (RA)

ZASO (RC)

PER:  
FOR:

YALE (I)

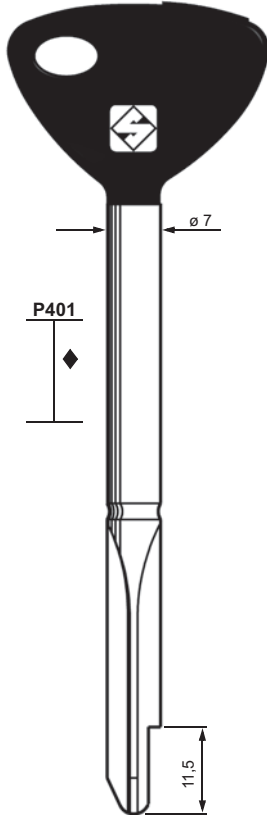

P401

ø 7

11,5

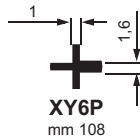

XY6P  
mm 108

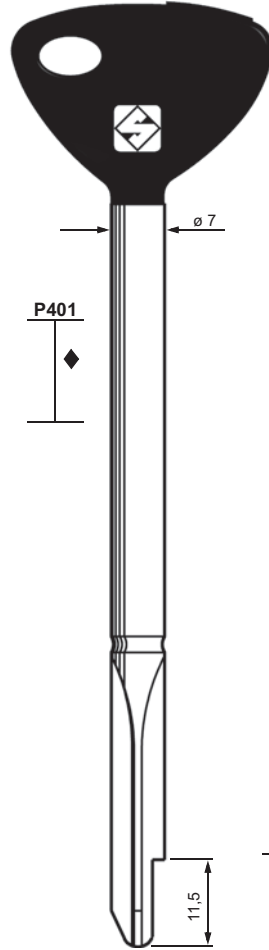

P401

ø 7

11,5

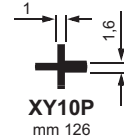

XY10P  
mm 126

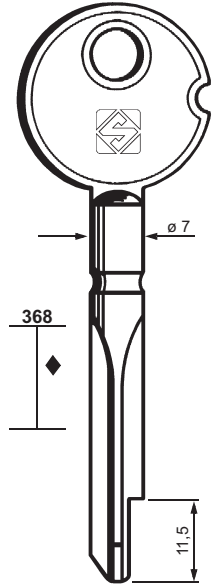

368

ø 7

11,5

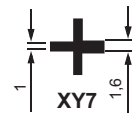

XY7

PER:  
FOR:

YALTRES

ZASO

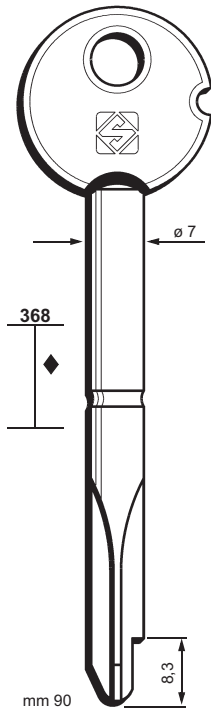

368

ø 7

mm 90

8,3

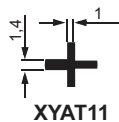

XYAT11

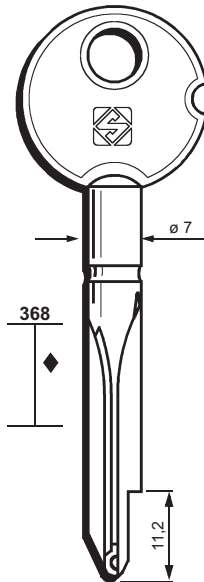

368

ø 7

11,2

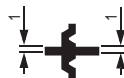

XZAS1

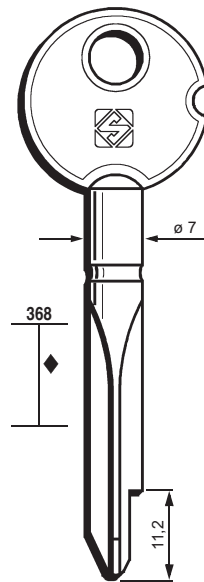

368

ø 7

11,2

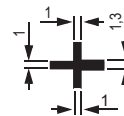

XZAS2

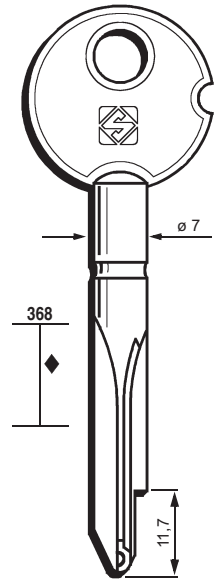

368

ø 7

11,7

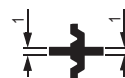

XZAS3

PER:  
FOR:

# ZEISS - IKON

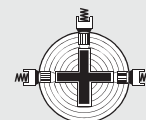

# 239

PER / FOR

ZEISS - IKON (D)

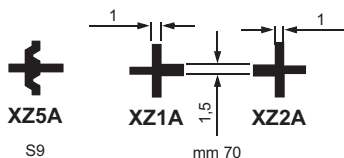
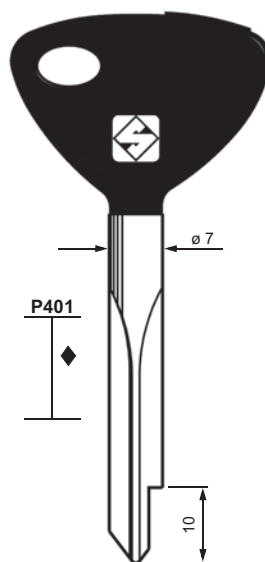
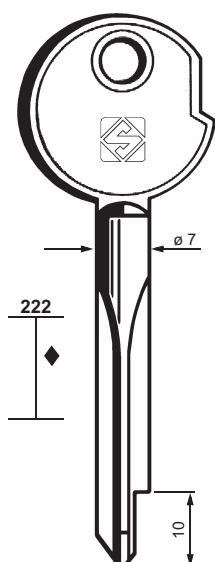

PER:  
FOR:

# ZEISS - IKON

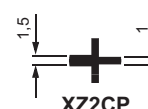
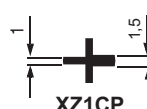
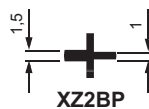
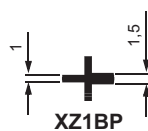
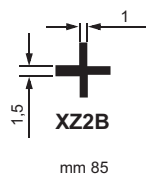
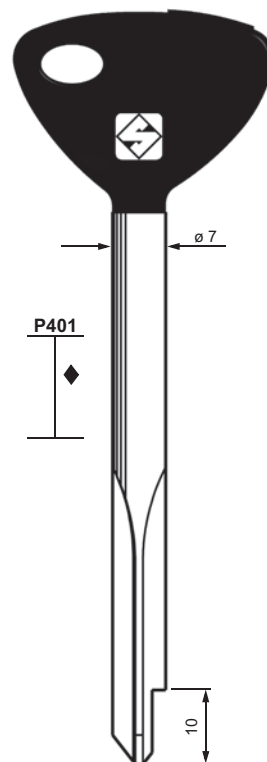
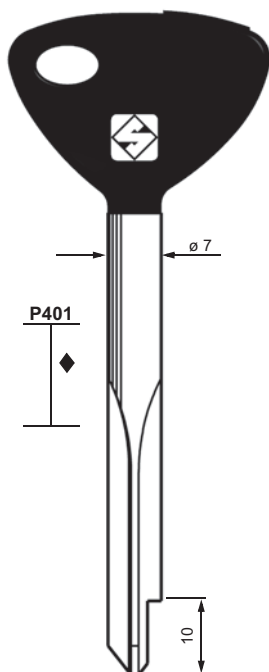
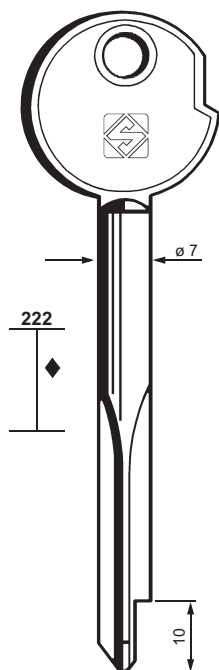

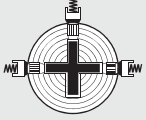

240

PER / FOR

ZEISS - IKON (D)  
LIPS

PER:  
FOR:

ZEISS - IKON

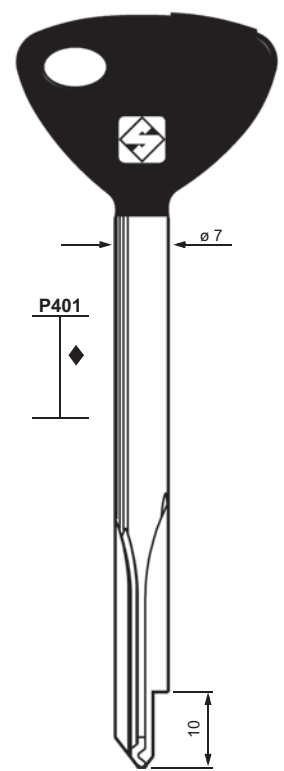
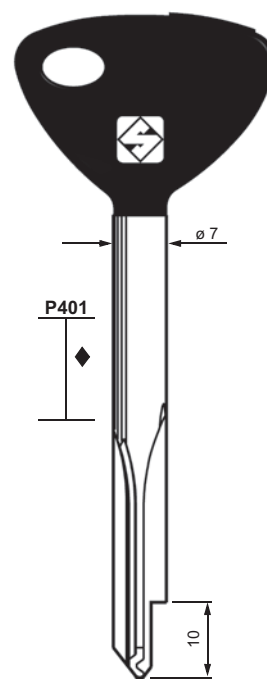
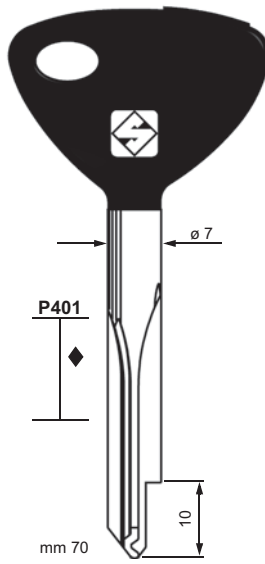
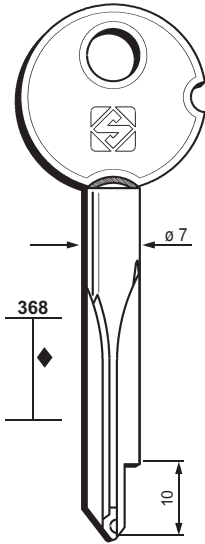

**XZ3A**  
S9  
mm 70

LIPS



**XZ3AP**  
S9

LIPS



**XZ6AP**  
VS9



**XZ3BP**  
S9  
mm 85



**XZ3CP**  
S9  
mm 100

PER:  
FOR: